

FAGOR

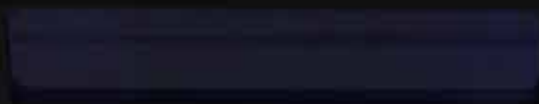





MENU





Dishwashing



	GLASSWASHER			FRONT LOADING			HOOD-TYPE	
	CONCEPT+	CONCEPT	ADVANCE	CONCEPT+	CONCEPT	ADVANCE	CONCEPT+	CONCEPT
Basket Size	400x400	400x400	350x350	500x500	500x500	500x500	500x500	500x500
CONTROL PANEL	OTHERS							
				AD-505			AD-125	
	With rinsing pump	COP-404			COP-504		COP-144	
	Without rinsing pump		CO-402			CO-502		CO-142
	Multi-power					CO-501		CO-110
	Single phase		CO-400	CO-350		CO-500		

One body, three ranges.

E-VO Generation is a dream come true, and goes one step further: This is a different and innovative generation... Revolutionary.

Because E-VO is built on a unique simple idea: It's creation a single body structure that offers common benefits for its three different ranges: E-VO ADVANCE, E-VO CONCEPT PLUS and E-VO CONCEPT.

All 3 ranges, advance, concept plus and concept, boast common structural characteristics:



Glasswasher

- Front-loading glass washers - E-VO Generation.
- Constructed in stainless steel.
- Double wall door.
- Double rotating wash and rinse system, top and bottom, in stainless steel.
- Rounded tank to facilitate washing and drainage.
- Stainless steel armoured heating elements in the wash tank and rinse boiler.
- Thermostatic control of temperatures (wash, 60°C, and rinse, 85°C).
- Safety thermostat
- Rinse aid doser incorporated.
- Fitted with non-return valve.
- 260 W wash pump
- Water consumption per 2.2 litre cycle.
- Magnetic safety stop switch in door opening.
- IPX4 anti-humidity protection.

CONCEPT PLUS
CONCEPT



Front loading

- Front-loading dishwashers - E-VO Generation.
- Constructed in stainless steel.
- Whole body with double wall.
- Counterbalanced door with stainless steel hinges and double spring.
- At 850 mm high meaning the unit can be positioned under a counter.
- Double rotating wash and rinse system, top and bottom, in stainless steel.
- Rounded tank to facilitate washing and drainage.
- Stainless steel armoured heating elements in the wash tank and rinse boiler.
- 3800 mm opening door height means GN pans can be washed.
- Thermostatic control of temperatures (wash, 60°C, and rinse, 85°C).
- 600 W wash pump with SOFT-START.
- Stainless steel armoured heating elements in the wash tank and rinse boiler.
- Water consumption per 2.4 litre cycle.
- Rinse aid doser incorporated.
- Magnetic safety stop switch in door opening.
- Safety thermostat.
- Model for 500 x 500 mm baskets.

- Hood-Type dishwashers - E-VO Generation

ADVANCE
CONCEPT PLUS
CONCEPT



Hood-type

- Constructed in stainless steel.
- Counterbalanced hood with handle and spring system.
- Double rotating wash and rinse system, top and bottom, in stainless steel.
- 440 mm hood opening (Accepts GN 1/1 trays).
- 750 W wash pump providing high water flow.
- Rounded tank to facilitate washing and drainage.
- Stainless steel armoured heating elements in the wash tank and rinse boiler.
- Multi-voltage: Allows the machine to be connected to a single-phase or three-phase voltage network. (230 1N~/230 3~/400V 3N~).
- AISI-304 stainless steel filter trays in the wash tank.
- Thermostatic control of temperatures (wash, 60°C, and rinse, 85°C).
- Thermal stop system which guarantees a rinse temperature of 85°C.
- Safety stop switch in hood opening.
- Safety thermostat.
- Water consumption per 2.4 litre cycle.
- Model for 500 x 500 mm baskets.

ADVANCE
CONCEPT PLUS
CONCEPT



The small and versatile solution for sparkling results.



Find out more!



Access the website



Sales brochure

Glasswasher

Concept +	207
Concept.....	208
Accessories	212

Water connection:
It is advisable to introduce sanitary water in the dishwashers, with a temperature of 50 - 60 °C.

Water pressure:
Minimum: 2 bar = 2 kg/cm²
Maximum: 4 bar = 4 kg/cm²

Water softener:
All glass / dishwashers should be connected to a treated water supply when the local supply is over 10 HF / 6 HD.

Any issues derived from a bad installation that don't meet with the indicated conditions will not be considered as a warranty.

Glasswashers | Concept +



General characteristics

- Electronic control and display of temperature, functions and errors.
- Control with help system for technical service.
- Thermostop system with rinse pump that guarantees a perfect hygienic result with a complete Glasswashing rinse temp at 63 degrees (EFFIRINSE) in accordance with the safety and hygiene specifications of standard DIN10512.
- Air Break check valve system type AA according to EN 1717/WRAS.
- Model for 400 x 400 mm baskets.
- 90s - 120s – 180s wash cycles and maximum production of 40 baskets/hour.
- Useful internal height of 270 mm.
- Tank with volume of 15 litres, with 2 kW heating element.
- Boiler with volume of 4 litres, with 2.8 kW heating element.

	MODEL	"CODE 50 HZ."	"CODE 60 HZ."	€	
CHARACTERISTICS					
Basic model	COP-404	19073733	19081232	-	
Rinse pump	A	A			
Voltage		230 V / 1N			
Power	(kW)	3,06			
Dimensions	(mm)	470x520x720			
Versions					
Built-in drain pump	B	COP-404 B	19075262	19081233	-
Built-in detergent doser	DD	COP-404 DD	19075263	19081234	-
Drainage pump and detergent doser	B - DD	COP-404 B DD	19075264	19081235	-

* Consult other possible factory versions.

ACCESORIES	
Stands	See page. 212
Conversion kits	See page. 212
Water softeners	See page. 268
Osmosis	See page. 268
Baskets	See page. 269

Accessories supplied: Two 400x 400 mm base baskets, 1 supplement for plates and a small basket for cutlery.

Glasswashers | Concept



CO-402

230 V
1 N

BASKET 400 x 400 mm

General characteristics

- Electronic control and display of temperature, functions and errors.
- Control with help system for technical service.
- Model for 400 x 400 mm baskets. 90s - 120s - 180s wash cycles and maximum production of 40 baskets/hour.
- Useful internal height of 270 mm.
- Tank with volume of 15 litres, with 2 kW heating element.
- Boiler with volume of 4 litres, with 2.8 kW heating element.
- Thermal stop system which guarantees a rinse temperature of 85°C. Standard factory setting disabled.

		MODEL	*CÓDIGO50 HZ.*	*CÓDIGO60 HZ.*	€
CHARACTERISTICS					
 Basic model		CO-402 COLD	19073542	19081225	-
Manual push button for final cold rinse	COLD	COLD			
Voltage		230 V / 1N			
Power	(kW)	3,06			
Dimensions	(mm)	470x520x720			
Versions					
Drainage pump	B	CO-402 COLD B	19075256	19081226	-
Peristaltic detergent doser	DD	CO-402 COLD DD	19075257	19081227	-
Bomba de desagüe y dosificador de detergente peristáltico	B - DD	CO-402 COLD B DD	19075254	19081228	-
Descaling system and tank with regeneration program	SOFT - DD	CO-402 COLD SOFT DD	19073547	19081229	-
UK type plug	B DD CI	CO-402 COLD B DD CI	19075260	19081231	-

* Consult other possible factory versions.

ACCESORIES	
Stands	See page. 212
Conversion kits	See page. 212
Water softeners	See page. 268
Baskets	See page. 269

Accessories supplied: Two 400x 400 mm base baskets, 1 supplement for plates and a small basket for cutlery.

Glasswashers | Concept







CO-400

BASKET 400 x 400 mm

General characteristics

- Highly resistant control buttons.
- 400 x 400 mm baskets.
- 120s fixed wash cycle and maximum production of 30 baskets/hour.
- Useful internal height of 270 mm.
- Tank with volume of 15 litres, with 2 kW heating element.
- Boiler with volume of 4 litres, with 2.8 kW heating element.

		MODEL	"CÓDIGO50 HZ."	"CÓDIGO60 HZ."	€
CHARACTERISTICS					
 Basic model		CO-400	19073541	19081255	-
Voltage		230 V / 1N			
Power	(kW)	3,06			
Dimensions	(mm)	470x520x720			
VERSIONS					
Drainage pump	B	CO-400 B	19081172	19081209	-
Peristaltic detergent doser	DD	CO-400 DD	19081173	19081220	-
UK type plug	CI	CO-400 CI	19075250	19081236	-
Cold model		CO-400 COLD	19073546	19081221	-
 Manual push button for final cold rinse	COLD	COLD			
VERSIONS					
 Drainage pump	B	CO-400 COLD B	19075251	19081222	-
 Peristaltic detergent doser	DD	CO-400 COLD DD	19075252	19081223	-
 Drainage pump and peristaltic detergent doser	B - DD	CO-400 COLD B DD	19075253	19081224	-
* Consult other possible factory versions.					
ACCESORIES					
Stands					See page. 212
Conversion kits					See page. 212
Water softeners					See page. 268
Baskets					See page. 269

Accessories supplied: Two 400x 400 mm base baskets, 1 supplement for plates and a small basket for cutlery.

Glasswashers | Concept



General characteristics

- Highly resistant control buttons.
- 350 x 350 mm baskets.
- 120s fixed wash cycle and maximum production of 30 baskets/hour.
- Useful internal height of 220 mm.
- Tank with volume of 11 litres, with 2 kW heating element.
- Boiler with volume of 4 litres, with 2.4 kW heating element.

		MODEL	"CODE 50 HZ."	CODE 60 HZ."	€
CHARACTERISTICS					
 Basic model		CO-350	19073540	19081136	-
Voltage		230 V / 1N			
Power	(kW)	2,66			
Dimensions	(mm)	430x480x660			
VERSIONS					
Drainage pump	B	CO-350 B	19075244	19081183	-
Peristaltic detergent doser	DD	CO-350 DD	19075245	19081184	-
Drainage pump and peristaltic detergent doser	B - DD	CO-350 B DD	19075246	19081185	-
CHARACTERISTICS					
Cold model		CO-350 COLD	19073545	19081186	-
Manual push button for final cold rinse	COLD	COLD			
VERSIONS					
Drainage pump	B	CO-350 COLD B	19075247	19081187	-
Peristaltic detergent doser	DD	CO-350 COLD DD	19075248	19081188	-
Drainage pump and peristaltic detergent doser	B - DD	CO-350 COLD B DD	19075249	19081189	-

* Consult other possible factory versions.

ACCESSORIES	
Stands	See page. 212
Conversion kits	See page. 212
Water softeners	See page. 268
Baskets	See page. 269

Accessories supplied: Two 350x 350 mm base baskets, 1 supplement for plates and a small basket for cutlery.

		CONCEPT +		CONCEPT	
TECHNICAL DATA		COP-404	CO-402	CO-400	CO-350
WASH CYCLES					
Cycle Time	[s]	90/120/180	90/120/180	120	120
THEORETICAL CAPACITY*1					
Baskets	[cestas/h]	40	40	30	30
Glasses	[vasos/h]	1000	1000	750	480
WATER CONSUMPTION					
Tank capacity	[l]	15	15	15	11
Boiler capacity		4	4	4	4
Rinse water consumption *2	[l]	2.2	2.2	2.2	2.2
TEMPERATURES					
Tank temperature	[°C]	60	60	60	60
Rinse water temperature	[°C]	85	85	85	85
DIMENSIONS					
Width	[mm]	470	470	470	430
Depth	[mm]	525	525	525	480
With the door open	[mm]	846	846	846	660
Height *3	[mm]	720	720	720	660
Useful height	[mm]	270	270	270	220
Basket size	[mm]	400X400	400X400	400X400	350X350
ELECTRICAL SPECIFICATIONS					
Total connected load (Alt)	[kW]	3.06	3.06	3.06	2.66
Fuse protection	[A]	16	16	16	16
Wash pump (P1)	[kW]	0.26	0.26	0.26	0.26
Tank power	[kW]	2	2	2	2
Rinse pump	[kW]	0.13	-	-	-
Boiler power	[kW]	2.8	2.8	2.8	2.4
Connection (factory default)		230V/50Hz/1N~	230V/50Hz/1N~	230V/50Hz/1N~	230V/50Hz/1N~
5,41 mm					
Min. inlet temperature	[°C]	15	15	15	15
Max. inlet temperature	[°C]	60	60	60	60
Required grid pressure ^a	[bar/kPA]	2-4/200-400	2-4/200-400	2-4/200-400	2-4/200-400
Max. drain height (only models B)	[mm]	500(B)	500(B)	500(B)	500(B)
Noise level (dBA)	[dBA]	<70	<70	<70	<70
Moisture protection		IPX4	IPX4	IPX4	IPX4
Net/gross weight	[kg]	35/42	35/42	35/42	30/37
Spray Arms		sst	sst	sst	Plast
ACCESSORIES					
Glasses basket	[un]	2	2	2	2
Small cutlery basket	[un]	1	1	1	1
Supplement for dishes	[un]	1	1	1	1

Accessories for glasswashers





Stand for glasswashers





- Made of stainless steel.

- It can be used to store the containers of detergent and rinse aid.

- Allows you to install the glasswashers without drain pump; the water drains by gravity.

MODEL	CODE	VALID FOR MODELS	CHARACTERISTICS	DIMENSIONS (mm)	€
 EVPL-47	19031298	CO-402 / CO-400	Capacity for 2 baskets 400x400	470x450x400	-
 EVPL-43	19031299	CO-350	Capacity for 2 baskets 350x350	430x405x400	-

Kit to transform the basic versions (except for soft versions)

MODEL	CODE	VALID FOR	DESCRIPTION	POWER (kW)	€
 DD 	19059327	Hood dishwashers Front-opening dishwashers Glasswashers	Peristáltic detergent doser	-	-
 B-AF 	19013376	Front-opening dishwashers Glasswashers	Kit drain pump - 50/60 hz.	35	-



Reliability and comfort
combined with high
efficiency.



Find out more!



Access the website



Sales brochure

Front loading dishwashers

Advance	215
Concept +	216
Concept.....	217
Accessories	222

Water connection:
It is advisable to introduce sanitary water in the dishwashers, with a temperature of 50 - 60 °C.

Water pressure:
Minimum: 2 bar = 2 kg/cm²
Maximum: 4 bar = 4 kg/cm²

Water softener:
All glass / dishwashers should be connected to a treated water supply when the local supply is over 10 HF / 6 HD.

Any issues derived from a bad installation that don't meet with the indicated conditions will not be considered as a warranty.



Front loading | Advance



AD-505

General characteristics

- Electronic and digital control.
- Digital display with information on programs, times and temperatures.
- Electronic programmer with help system for technical service.
- Rinse pump that guarantees a perfect hygienic result with a complete rinse at 80–85 °C (EFFIRINSE) in accordance with the safety and hygiene specifications of standard DIN10512.
- 60s, 90s, 120s and 'Glass' wash cycles.
- Theoretical maximum production of 60 baskets/hour.
- Tank with volume of 14 litres, with 1 kW heating element.
- Single-phase Multipower installation, with heating in the boiler which can be selected at time of installation, 1,9 / 2,8 / 3,73 / 5,6 kW.
- Multi-voltage: Allows the machine to be connected to a single-phase or three-phase voltage network (230 1N~/230 3~/400V 3N~).
- Simultaneous tank and boiler heating.
- Boiler with 5.6 kW heating element.
- Water consumption per 2.4 litre cycle.
- Stainless steel filter trays in the tank.
- IPX5 anti-humidity protection.

		MODEL	"CODE 50 HZ."	"CODE 60 HZ."	€
CHARACTERISTICS					
	Basic model	AD-505	19073539	19076140	-
	Rinse pump	A	A		
	Drainage pump	B	B		
	Peristaltic detergent doser	DD	DD		
	Voltage		MULTIVOLTAGE		
	Power	(kW)	MULTIPOWER		
	Dimensions	(mm)	600x600x830		
Versions					
	Descaling system and tank with regeneration program	SOFT	AD-505 SOFT	19076139	19076141

ACCESORIES	
Stands	See page 222
Conversion kits	See page 222
Water softeners	See page 268
Osmosis	See page 268
Baskets	See page 269



Accessories supplied: One CT-10 base basket, 1 CP-16/18 basket for plates and two cutlery holders.

Front loading | Concept+



General characteristics

- Electronic control and display of temperature, functions and errors.
- Control with help system for technical service.
- Thermostop system with rinse pump that guarantees a perfect hygienic result with a complete rinse at 80–85 °C (EFFIRINSE) in accordance with the safety and hygiene specifications of standard DIN10512.
- Air Brake check valve system type AA according to EN 1717/WRAS.
- 90s, 120s y 180s wash cycles.
- Theoretical maximum production of 40 baskets/hour.
- Tank with volume of 20 litres, with 2.8 kW heating element.
- Boiler with 5.6 kW heating element.
- Single-phase Multipower installation, with heating in the boiler which can be selected at time of installation, either 2,8 / 3,7 kW.
- Multi-voltage: Allows the machine to be connected to a single-phase or three-phase voltage network. (230 1N~/230 3~/400V 3N~).
- Double system of filter trays in the tank.
- IPX4 anti-humidity protection.

	MODEL	"CODE 50 HZ."	"CODE 60 HZ."	€	
CHARACTERISTICS					
 Basic model	COP-504	19073538	19076137	-	
Rinse pump	A	A			
Voltage	MULTIVOLTAGE				
Power	(kW)	MULTIPOWER			
Dimensions	(mm)	600x600x830			
VERSIONS					
Drainage pump	B	COP-504 B	19076134	19076138	-
Peristaltic detergent doser	DD	COP-504 DD	19076135	19081178	-
 Peristaltic detergent doser	B DD	COP-504 B DD	19076136	19081179	-
 UK type plug	CI	COP-504 CI	19083240	19083241	-
With pump, dispenser and British plug	B DD CI	COP-504 B DD CI	19076805	19083242	-

* Consult other possible factory versions.

ACCESORIES	
Stands	See page 222
Conversion kits	See page 222
Water softeners	See page 268
Osmosis	See page 268
Baskets	See page 269

Accessories supplied: One CT-10 base basket, 1 CP-16/18 basket for plates and two cutlery holders.

Front loading | Concept



General characteristics

- Electronic control and display of temperature, functions and errors.
- Control with help system for technical service.
- 90s, 120s y 180s wash cycles.
- Theoretical maximum production of 40 baskets/hour.
- Tank with volume of 20 litres, with 2.8 kW heating element.
- Single-phase Multipower installation, with heating in the boiler which can be selected at time of installation, either 2,8 / 3,7 kW.
- Multi-voltage: Allows the machine to be connected to a single-phase or three-phase voltage network. (230 1N~/230 3~/400V 3N~).
- Tray-filter in the wash tank.
- IPX4 anti-humidity protection.
- Thermal stop system which guarantees a rinse temperature of 85°C. Standard factory setting disabled.

CO-502

		MODELO	"CÓDIGO 50 HZ."	"CÓDIGO 60 HZ."	€
CHARACTERISTICS					
Basic model		CO-502	19073537	19076131	-
Voltage		MULTIVOLTAGE			
Power	(kW)	MULTIPOWER			
Dimensions	(mm)	600x600x830			
VERSIONS					
Drainage pump	B	CO-502 B	19076115	19076132	-
Peristaltic detergent doser	DD	CO-502 DD	19076116	19076133	-
Drainage pump and peristaltic detergent doser	B - DD	CO-502 B DD	19076117	19083235	-
UK type plug	CI	CO-502 CI	19076118	19083236	-
With pump, detergent dispenser and British plug	B DD CI	CO-502 B DD CI	19076806	19076119	-

* Consult other possible factory versions.

ACCESORIES	
Stands	see pag 222
Conversion kits	see pag 222
Water softeners	see pag 268
Baskets	see pag 269



Accessories supplied: One CT-10 base basket, 1 CP-16/18 basket for plates and two cutlery holders.

Front loading | Concept



General characteristics

- Highly resistant control buttons.
- 90s, 120s y 180s wash cycles.
- Theoretical maximum production of 40 baskets/hour.
- Tank with volume of 20 litres, with 2.8 kW heating element.
- Single-phase Multipower installation, with heating in the boiler which can be selected at time of installation, either 2,8 / 3,7 kW.
- Multi-voltage: Allows the machine to be connected to a single-phase or three-phase voltage network. (230 1N~/230 3~/400V 3N~).
- Tray-filter in the wash tank.
- IPX4 anti-humidity protection.
- Thermal stop system which guarantees a rinse temperature of 85°C. Standard factory setting disabled.

		MODEL	"CODE 50 HZ."	"CODE 60 HZ."	€	
CHARACTERISTICS						
	Basic model	CO-501	19073534	19076111	-	
	Voltage	MULTIVOLTAGE				
	Power (kW)	MULTIPOWER				
	Dimensions (mm)	600x600x830				
VERSIONS						
	Drainage pump	B	CO-501 B	19076106	19076112	-
	Peristaltic detergent doser	DD	CO-501 DD	19076107	19076113	-
	Drainage pump and peristaltic detergent doser	B - DD	CO-501 B DD	19076108	19081175	-
	UK type plug	CI	CO-501 CI	19076109	19076114	-

* Consult other possible factory versions.

ACCESORIES	
Stands	see pag 222
Conversion kits	see pag 222
Water softeners	see pag 268
Baskets	see pag 269





Accessories supplied: One CT-10 base basket, 1 CP-16/18 basket for plates and two cutlery holders.

Front loading | Concept



General characteristics

- Highly resistant control buttons.
- 120s wash cycle.
- Theoretical maximum production of 30 baskets/hour.
- Tank with volume of 20 litres, with 2.8 kW heating element.
- Water consumption per 2.4 litre cycle.
- Tray-filter in the wash tank.
- IPX4 anti-humidity protection.
- Thermal stop system which guarantees a rinse temperature of 85°C. Standard factory setting disabled.

	MODEL	"CODE 50 HZ."	"CODE 60 HZ."	€	
CHARACTERISTICS					
 Basic model	CO-500	19073532	19076101	-	
Voltage	230 V / 1N				
Power (kW)	MULTIPOWER				
Dimensions (mm)	600x600x830				
VERSIONS					
 Drainage pump	B	CO-500 B	19075467	19076102	-
 Peristaltic detergent doser	DD	CO-500 DD	19075468	19076103	-
 Drainage pump and peristaltic detergent doser	B - DD	CO-500 B DD	19075469	19076104	-

* Consult other possible factory versions.

ACCESORIES	
Stands	see pag 222
Conversion kits	see pag 222
Water softeners	see pag 268
Baskets	see pag 269

Accessories supplied: One CT-10 base basket, 1 CP-16/18 basket for plates and two cutlery holders.

		ADVANCE	CONCEPT +		CONCEPT	
Technical data		AD-505	COP-504	CO-502	CO-501	CO-500
WASH CYCLES						
Cycle Time	[s]	60/90/180	90/120/180	90/120/180	90/120/180	120
THEORETICAL CAPACITY*1						
Baskets	[cestas/h]	60	40	40	40	30
Plates	[platos/h]	1080	720	720	720	540
Glasses	[vasos/h]	2160	1440	1440	1440	1080
WATER CONSUMPTION						
Tank capacity	[l]	14	20	20	20	20
Boiler capacity		7	7	7	7	7
Rinse water consumption per cycle *2	[l]	2.4	2.4	2.4	2.4	2.4
TEMPERATURES						
Tank temperature	[°C]	60 (55-71)	60	60	60	60
Rinse water temperature	[°C]	82 (65-85)/PG 65	85	85	85	85
DIMENSIONS						
Width	[mm]	600	600	600	600	600
Depth	[mm]	602	602	602	602	602
With the door open	[mm]	1020	1020	1020	1020	1020
With water softener		1060	1060	1060	1060	1060
Height *3	[mm]	840	840	840	840	840
Useful height	[mm]	360	360	360	360	360
Basket size	[mm]	500X500	500X500	500X500	500X500	500X500
ELECTRICAL SPECIFICATIONS						
Total connected load (Alt/Sim)	[kW]	See table	See table	See table	See table	See table
Fuse protection	[A]	See table	See table	See table	See table	See table
Wash pump (P1)	[kW]	0.59	0.59	0.59	0.59	0.59
Tank power	[kW]	1	2,8	2,8	2,8	2,8
Rinse pump	[kW]	0.25	0.25	-	-	-
Boiler power	[kW]	See table	See table	See table	See table	2,8
Connection (factory default)		230V/50Hz/1N~	230V/50Hz/1N~	230V/50Hz/1N~	230V/50Hz/1N~	230V/50Hz/1N~
OTHER INFORMATION						
Min. inlet temperature	[°C]	15	15	15	15	15
Max. inlet temperature	[°C]	60	60	60	60	60
Required grid pressure	[bar/kPA]	1.0-4.0/100-400	1.0-4.0/100-400	2.0-4.0/200-400	2.0-4.0/200-400	2.0-4.0/200-400
Max. drain height (only B models)	[mm]	500	500(B)	500(B)	500(B)	500(B)
Noise level (dBA)	[dBA]	<65	<65	<65	<65	<65
Moisture protection		IPX5	IPX4	IPX4	IPX4	IPX4
Net/gross weight	[kg]	60/77	60/77	58/75	58/75	58/75
Spray Arms		sst	sst	sst	sst	sst
ACCESSORIES						
Glasses basket	[un]	1	1	1	1	1
Small cutlery basket	[un]	2	2	2	2	1
Baskets for plates	[un]	1	1	1	1	1

*1 Customer circumstances (inlet water temperature/electrical connection) may reduce the values indicated here.

*2 Non-binding information. The actual rinse water requirements may vary depending on site conditions.

*3 The adjustable feet allow the vertical dimensions to be raised as required up to 25 mm.

	VOLTAGE	FACTORY DEFAULT	FUSE PROTECTION	TOTAL AMP.	TOTAL CONNECTED LOAD	CONNECTION	TANK POWER	BOILER POWER	WASH PUMP POWER
AD-505	380 V - 415 V / 3N~		16 A	15 A	7.2 kW	SIM	1 kW	5,6 kW	0.6 kW
	220 V - 240 V / 1N~		13 A	10.7 A	2.5 kW	ALT	1 kW	1.9 kW	0.6 kW
	220 V - 240 V / 1N~	FD	16 A	15 A	3.5 kW	SIM	1 kW	1.9 kW	0.6 kW
	220 V - 240 V / 1N~		20 A	19.1 A	4.4 kW	SIM	1 kW	2.8 kW	0.6 kW
	230 V / 3~		25 A	21 A	7.2 kW	SIM	1 kW	5,6 kW	0.6 kW
COP-504	380 V - 415 V / 3N~		16 A	14,7 A	6.2 kW	ALT	2.8 kW	5,6 kW	0.6 kW
CO-502	220 V - 240 V / 1N~	FD	16 A	14.7 A	3.4 kW	ALT	2.8 kW	2.8 kW	0.6 kW
CO-501	220 V - 240 V / 1N~		20 A	18.8 A	4.3 kW	ALT	2.8 kW	3.7 kW	0.6 kW
	230 V / 3~		20 A	16.6 A	6.2 kW	ALT	2.8 kW	5,6 kW	0.6 kW
CO-500	220 V - 240 V / 1N~	FD	16 A	14.7 A	3.4 kW	ALT	2.8 kW	2.8 kW	0.6 kW



Accessories for front loading







Stands for front loading dishwashers

- Made of stainless steel.
- Valid for the front loading dishwashers of the E-VO Generation.
- Space for baskets 500 x 500 mm.
- Capacity for 3 baskets height 110 mm (CT-10, CP-16/18, CV-16/105...).
- It can be used to store the containers of detergent and rinse aid.
- Allows you to install the dishwasher without drain pump; the water drains by gravity.



MODEL	CODE	CHARACTERISTICS	DIMENSIONS (mm)	€
EVPL-60	19004660	Capacity for 3 baskets 500x500	600x600x400	-

Transformation kits for E-VO dishwashers

Kit to transform the basic versions (except for soft versions)

MODEL	CODE	VALID FOR	DESCRIPTION	POWER (kW)	€
 DD 	19059327	HOOD DISHWASHERS FRONT-OPENING DISHWASHERS GLASSWASHERS	PERISTÁLTIC DETERGENT DOSER	-	-
 B-AF 	19013376	FRONT-OPENING DISHWASHERS GLASSWASHERS	KIT DRAIN PUMP - 50/60 Hz.	35	-

Kit trays-filter for wash tank

MODEL	CODE	DESCRIPTION	€
 K-BF-500 	19087264	KIT 2 TRAYS-FILTER FOR WASH TANK	-

Optional kit for marine version

MODEL	CODE	VALID FOR	CHARACTERISTICS	€
KIT MARINE AF	19036061	COP-504, CO-502, CO-501, CO-500	Connection for ships	-



Simplicity and agility
for large quantities
and intensive use.



Find out more!



Access the website



Sales brochure

Hood-type dishwashers

Advance	225
Concept +	227
Concept.....	228
Accessories	232

Water connection:
It is advisable to introduce sanitary water in the dishwashers, with a temperature of 50 - 60 °C.

Water pressure:
Minimum: 2 bar = 2 kg/cm²
Maximum: 4 bar = 4 kg/cm²

Water softener:
All glass / dishwashers should be connected to a treated water supply when the local supply is over 10 HF / 6 HD.



Any issues derived from a bad installation that don't meet with the indicated conditions will not be considered as a warranty.

Hood-type | Advance



General characteristics

- Electronic and digital control.
- Digital display with information on programs, times and temperatures.
- Electronic programmer with help system for technical service.
- Rinse pump which guarantees a perfect hygiene result with complete linear rinse cycle at 85°C. (EFFIRINSE) in accordance with the safety and hygiene specifications of the DIN10512 standard.
- 55s, 75s, 120s, 480s and 'Glass' wash cycles.
- Theoretical maximum production of 65 baskets/hour (1170 plates/h).
- Program for tank emptying.
- Double-walled Hood with special compressed insulating material.
- Tank with volume of 28 litres, with 2.1 kW heating element.
- Boiler with volume of 9 litres, with 9 kW heating element.
- Simultaneous tank and boiler heating.
- Maximum Total power: 11.85 kW (simultaneous).
- Drainage pump - power 70 W - tank emptying program.
- Rinse aid doser incorporated.
- Rinse aid doser incorporated.
- IPX5 anti-humidity protection.

	MODEL	"CODE 50 HZ."	"CODE 60 HZ."	€	
CHARACTERISTICS					
 Basic model	AD-125	19073921	19075047	-	
Rinse pump	A	A			
Drainage pump	B	B			
Peristaltic detergent doser	DD	DD			
Voltage		MULTIVOLTAGE			
Power	(kW)	MULTIPOWER			
Dimensions	(mm)	630 x 750 x 1.465			
VERSIONS					
 Descaling system and tank with regeneration program	SOFT	AD-125 SOFT	19075295	19075298	-
CHARACTERISTICS					
Model with recovery system	AD-125 HRS	19075296	19075299	-	
Heat recovery system	HRS	HRS			
Dimensions	(mm)	630 x 750 x 1.990			
VERSIONS					
 Descaling system and tank with regeneration program and detergent dispenser	SOFT	AD-125 SOFT HRS	19074195	19075048	-
* Consult other possible factory versions.					
ACCESSORIES					
Entry-exit tables		see page 232			
Conversion kits		see page 234			
Water softeners		see page 268			
Osmosis		see page 268			
Baskets		see page 269			

Hood-type | Advance



General characteristics

- Electronic and digital control.
- Digital display with information on programs, times and temperatures.
- Electronic programmer with help system for technical service.
- Rinse pump which guarantees a perfect hygiene result with complete linear rinse cycle at 85°C. (EFFIRINSE) in accordance with the safety and hygiene specifications of the DIN10512 standard.
- 55s, 75s, 120s and 480s wash cycles.
- Double-walled Hood with special compressed insulating material.
- Tank with volume of 28 litres, with 2.1 kW heating element.
- The ECO version Hood-Type dishwashers are fitted with an external hot water generator, gas heated, model GWB-20.
- The generator replaces the electric rinse boiler in the dishwasher, bringing a significant saving in electricity consumption.

	MODEL	"CODE 50 HZ."	"CODE 60 HZ."	€
CHARACTERISTICS				
Basic model	AD-125 ECO	19075300	19075301	-
Rinse pump	A	A		
Drainage pump	B	B		
Peristaltic detergent doser	DD	DD		
Voltage	MULTIVOLTAGE			
Power	(kW)	2,70		
Dimensions	(mm)	630 x 750 x 1.465		

(1) Note on codes

When placing your order, to the machine code, please add the generator code GWB-20 (according to the type of gas and electrical frequency), included in the price.

Gas hot water generator GWB-20

Forced draught burner and double safety valve. Electronic control of temperature and water levels. Automatic limescale removal. Automatic tank emptying.

	MODEL	"CODE 50 HZ."	"CODE 60 HZ."	€
Power	(kW)	20		
Dimensions	(mm)	432x548x770		
Butane/propane gas	LPG	GWB-20 LPG	19010831	19044806
Natural gas	GN	GWB-20 GN	19038551	19044807



Accessories supplied: One CT-10 base basket, 1 CP-16/18 basket for plates and two cutlery holders.

Hood-type | Concept+



General characteristics

- Electronic control and display of temperature, functions and errors.
- Control with help system for technical service.
- Thermostop system with rinse pump that guarantees a perfect hygienic result with a complete rinse at 80–85 °C (EFFIRINSE) in accordance with the safety and hygiene specifications of standard DIN10512.
- Air Brake check valve system type AA according to EN 1717/WRAS.
- 55s, 75s, 120s and 600s wash cycles.
- Theoretical maximum production of 65 baskets/hour (1170 plates/h).
- Tank with volume of 33 litres, with 4.5 kW heating element.
- Boiler with volume of 9 litres, with 9 kW heating element.
- Alternating or simultaneous tank and boiler heating.
- Maximum Total power: 9.75 kW (alternating) or 14.75 kW (simultaneous).
- IPX4 anti-humidity protection.

		MODEL	*CÓDIGO 50 HZ.*	*CÓDIGO 60 HZ.*	€	
CHARACTERISTICS						
	Basic model	COP-144	19073920	19075045	-	
	Rinse pump	A	A			
	Voltage	MULTIVOLTAGE				
	Power	(kW)	9,75 / 14,25			
	Dimensions	(mm)	630 x 750 x 1.465			
VERSIONS						
	Drainage pump	B	COP-144 B	19075288	19075292	-
	Peristaltic detergent doser	DD	COP-144 DD	19075289	19075293	-
	Drainage pump and detergent doser	B - DD	COP-144 B DD	19075290	19075294	-
CHARACTERISTICS						
	Model with recovery system	COP-144 HRS	19075044	19075046	-	
	Heat recovery system	HRS	HRS			
	Dimensions	(mm)	630 x 750 x 1.990			
Versions						
	Drainage pump and detergent doser	B - dd	COP-144 HRS B DD	19075291	19081123	-

* Consult other possible factory versions.

ACCESORIES	
Entry-exit tables	see page 232
Conversion kits	see page 234
Water softeners	see page 268
Osmosis	see page 268
Baskets	see page 269



Accessories supplied: One CT-10 base basket, 1 CP-16/18 basket for plates and two cutlery holders.

Hood-type | Concept



General characteristics

- Electronic control and display of temperature, functions and errors.
- 55s, 75s, 120s and 600s wash cycles.
- Theoretical maximum production of 65 baskets/hour (1170 plates/h).
- Tank with volume of 33 litres, with 4.5 kW heating element.
- Boiler with volume of 9 litres, with 9 kW heating element.
- Alternating or simultaneous tank and boiler heating.
- Thermal stop system which guarantees a rinse temperature of 85°C. Standard factory setting disabled.
- Maximum Total power: 9.75 kW (alternating) or 14.75 kW (simultaneous).
- IPX4 anti-humidity protection.

		MODEL	"CODE 50 HZ."	"CODE 60 HZ."	€	
CHARACTERISTICS						
	Basic model	CO-142	19073919	19075042	-	
	Voltage	MULTIVOLTAGE				
	Power (kW)	9,75 / 14,25				
	Dimensions (mm)	630 x 750 x 1.465				
VERSIONS						
	Drainage pump	B	CO-142 B	19075277	19075285	-
	Peristaltic detergent doser	DD	CO-142 DD	19075278	19075286	-
	Drainage pump and detergent doser	B - DD	CO-142 B DD	19075279	19075287	-
	CHARACTERISTICS					
	Model with recovery system	CO-142 HRS	19075041	19075043	-	
	Heat recovery system	HRS	HRS			
	Dimensions (mm)	630 x 750 x 1.990				
VERSIONS						
	Drainage pump and detergent doser	B - DD	CO-142 HRS B DD	19075282	19081120	-

* Consult other possible factory versions.

ACCESSORIES	
Entry-exit tables	see page. 232
Conversion kits	see page. 234
Water softeners	see page. 268
Baskets	see page. 269



Accessories supplied: One CT-10 base basket, 1 CP-16/18 basket for plates and two cutlery holders.

Hood-type | Concept



General characteristics

- Highly resistant control buttons.
- 90s, 120s, 180s and 600s wash cycles.
- Theoretical maximum production of 40 baskets/hour.
- Tank with volume of 33 litres, with 4.5 kW heating element.
- Boiler with volume of 9 litres, with 6 kW heating element.
- Alternating or simultaneous tank and boiler heating.
- Thermal stop system which guarantees a rinse temperature of 85°C. Standard factory setting disabled.
- Maximum Total power: 6.75 kW (alternating) or 11.25 kW (simultaneous).
- IPX4 anti-humidity protection.

		MODEL	"CODE 50 HZ."	"CODE 60 HZ."	€	
CHARACTERISTICS						
	Basic model	CO-110	19073548	19075029	-	
	Voltage	MULTIVOLTAGE				
	Power (kW)	6,75 / 11,25				
	Dimensions (mm)	630 x 750 x 1.465				
VERSIONS						
	Drainage pump	B	CO-110 B	19075270	19075274	-
	Peristaltic detergent doser	DD	CO-110 DD	19075271	19075275	-
	Drainage pump and detergent doser	B - DD	CO-110 B DD	19075272	19075276	-
	CHARACTERISTICS					
	Model with recovery system	CO-110 HRS	19075016	19075040	-	
	Heat recovery system	HRS	HRS			
	Dimensions (mm)	630 x 750 x 1.990				
VERSIONS						
	Drainage pump and detergent doser	B - DD	CO-110 HRS B DD	19075273	19081101	-

* Consult other possible factory versions.

ACCESSORIES	
Entry-exit tables	see page 232
Conversion kits	see page 234
Water softeners	see page 268
Baskets	see page 269

Accessories supplied: One CT-10 base basket, 1 CP-16/18 basket for plates and two cutlery holders.

		ADVANCE		CONCEPT +		CONCEPT	
TECHNICAL DATA		AD-125	AD-125 eco	COP-144	CO-142	CO-110	
WASH CYCLES							
Cycle Time	[s]	55/75/120/480	55/75/120/480	55/75/120/600	55/75/120/600	90/120/180/600	
THEORETICAL CAPACITY*1							
Baskets	[cestas/h]	65	65	65	65	40	
Plates	[platos/h]	1170	1170	1170	1170	720	
Glasses	[vasos/h]	2340	2340	2340	2340	1440	
WATER CONSUMPTION							
Tank capacity	[l]	28	28	33	33	33	
Boiler capacity		10	13	10	9	9	
Rinse water consumption per cycle *2	[l]	2.4	2.4	2.4	2.4	2.4	
TEMPERATURES							
Tank temperature	[°C]	60 (55-71)	60 (55-71)	60	60	60	
Rinse water temperature	[°C]	82 (65-85)	82 (65-85)	85	85	85	
DIMENSIONS							
Width	[mm]	712	712	712	712	712	
Depth	[mm]	750 (827)	750 (827)	750 (827)	750 (827)	750 (827)	
Height with hood closed *3	[mm]	1465	1465	1465	1465	1465	
Height with hood open	[mm]	1940	1940	1940	1940	1940	
Height with HRS	[mm]	1990	1990	1990	1990	1990	
Operating height	[mm]	820-890	820-890	820-890	820-890	820-890	
Useful height	[mm]	430	430	430	430	430	
Basket size	[mm]	500x500	500x500	500x500	500x500	500x500	
ELECTRICAL SPECIFICATIONS							
Total power connected(Alt/Sim)	[kW]	Ver tabla	Ver tabla	Ver tabla	Ver tabla	Ver tabla	
Fuse protection	[A]	Ver tabla	Ver tabla	Ver tabla	Ver tabla	Ver tabla	
Wash pump (P1)	[kW]	0.75	0.75	0.75	0.75	0.75	
Tank power	[kW]	2.1	2.1	4.5	4.5	4.5	
Rinse pump	[kW]	0.25	0.25	0.25	-	-	
Boiler power	[kW]	9	-	9	9	6	
Connection (factory default)		400V/50Hz/3N~	400V/50Hz/3N~	400V/50Hz/3N~	400V/50Hz/3N~	400V/50Hz/3N~	
OTHER INFORMATION							
Min. inlet temperature	[°C]	15	15	15	15	15	
Max. inlet temperature	[°C]	60	60	60	60	60	
Grid pressure	[bar/kPA]	1.0-4.0/100-400	1.0-4.0/100-400	1.0-4.0/100-400	2.0-4.0/200-400	2.0-4.0/200-400	
Grid pressure requerida para HRS	[bar/kPA]	2.0-4.0/200-400	2.0-4.0/200-400	2.0-4.0/200-400	2.0-4.0/200-400	2.0-4.0/200-400	
Max. drain height (only B models)	[mm]	600	600	130/600(B)	130/600(B)	130/600(B)	
Noise level (dBA)	[dBA]	<65	<65	<70	<70	<70	
Moisture protection		IPX5	IPX5	IPX4	IPX4	IPX4	
Net/gross weight	[kg]	111/129	109/127	97/115	95/113	95/113	
Net/gross weight with HRS	[kg]	127/147	125/145	113/133	111/131	111/131	
Spray Arms		sst	sst	sst	sst	sst	
ACCESSORIES							
Glasses basket	[un]	1	1	1	1	1	
Small cutlery basket	[un]	2	2	2	2	2	
Baskets for plates	[un]	1	1	1	1	1	

- * 1 Customer circumstances (inlet water temperature/electrical connection) may reduce the values indicated here.
- * 2 Non-binding information. The actual rinse water requirements may vary depending on site conditions.
- * 3 The adjustable feet allow the vertical dimensions to be raised as required up to 25 mm.
- * 4 4 Models with energy recovery (HRS): Total kW + 0.5 kW & Total Amp.+ 0.4 A.

	VOLTAGE	FACTORY DEFAULT	FUSE PROTECTION	TOTAL AMP.	TOTAL CONNECTED LOAD	CONNECTION	TANK POWER	BOILERPOWER	WASH PUMP POWER
AD-125	380 V - 415 V / 3N~	FD	20 A	18.7 A	11,85 kW	SIM	2.1 kW	9 kW	0.75 kW
	220 V - 240 V / 1N~		32 A	26.7 A	6,35 kW	SIM	1.1 kW	4.5 kW	0.75 kW
	220 V - 240 V / 1N~		40 A	34.8 A	8,15 kW	SIM	1.4 kW	6 kW	0.75 kW
	230 V / 3~		40 A	30,5 A	11,85 kW	SIM	2.1 kW	9 kW	0.75 kW
AD-125 eco	380 V - 415 V / 3N~	FD	16 A	5.7 A	2,85 kW	-	2.1 kW	-	0.75 kW
	220 V - 240 V / 1N~		16 A	11.8 A	2,85 kW	-	2.1 kW	-	0.75 kW
	230 V / 3~		16 A	7.9 A	2,85 kW	-	2.1 kW	-	0.75 kW
"COP-144 CO-142"	380 V - 415 V / 3N~		20 A	15.7 A	9,75 kW	ALT	4.5 Kw	9 kW	0.75 kW
	380 V - 415 V / 3N~	FD	25 A	22.2 A	14,25 kW	SIM	4.5 Kw	9 kW	0.75 kW
	220 V - 240 V / 1N~		25 A	22.2 A	5,25 kW	ALT	2.3 Kw	4.5 kW	0.75 kW
	220 V - 240 V / 1N~		32 A	28.7 A	6,75 kW	ALT	3 Kw	6 kW	0.75 kW
	220 V - 240 V / 1N~		50 A	41.8 A	9,75 kW	ALT	4.5 Kw	9 kW	0.75 kW
	220 V - 240 V / 1N~		40 A	32 A	7,55 kW	SIM	2.3 Kw	4.5 kW	0.75 kW
	220 V - 240 V / 1N~		50 A	41.8 A	9,75 kW	SIM	3 Kw	6 kW	0.75 kW
	230 V / 3~		32 A	25.2 A	9,75 kW	ALT	4.5 Kw	9 kW	0.75 kW
	230 V / 3~		40 A	36.5 A	14,25 kW	SIM	4.5 Kw	9 kW	0.75 kW
CO-110	380 V - 415 V / 3N~		16 A	11.3 A	6,75 kW	ALT	4.5 Kw	6 kW	0.75 kW
	380 V - 415 V / 3N~	FD	20 A	17.8 A	11,25 kW	SIM	4.5 Kw	6 kW	0.75 kW
	220 V - 240 V / 1N~		20 A	15.7 A	3,75 kW	ALT	2.25 Kw	3 kW	0.75 kW
	220 V - 240 V / 1N~		25 A	20 A	4,75 kW	ALT	3 Kw	4 kW	0.75 kW
	220 V - 240 V / 1N~		32 A	28.7 A	6,75 kW	ALT	4.5 Kw	6 kW	0.75 kW
	220 V - 240 V / 1N~		32 A	25.7 A	6,05 kW	SIM	2.25 Kw	3 kW	0.75 kW
	220 V - 240 V / 1N~		40 A	33 A	7,75 kW	SIM	3 Kw	4 kW	0.75 kW
	220 V - 240 V / 1N~		50 A	48,3 A	11,25 kW	SIM	4.5 Kw	6 kW	0.75 kW
	230 V / 3~		20 A	17.7 A	6,75 kW	ALT	4.5 Kw	6 kW	0.75 kW
	230 V / 3~		32 A	29 A	11,25 kW	SIM	4.5 Kw	6 kW	0.75 kW

Tables for hood type dishwashers

Entry and exit tables



General characteristics

- Wide range of entry / exit and pre-rinsing tables, to provide solutions for every need and space.
- Designed for 500 x 500 mm dishwashing baskets.
- Quick installation and easy connection to the dishwasher.
- No holes on the surface.

- Constructed in AISI-304 stainless steel (18/10). 40 x 40 mm square tubular legs in AISI-304 stainless, adjustable in height.
- Deep anti-drip profiles completely folded with lower edge for safe and easy cleaning.

Equipment:

- 100 mm splashback (P).
- Embedded bowl (F), fully integrated in the top.
- Bowl dimensions: 450 x 450 x 250 mm.
- Lower rack (E).
- Waste scraping hole with rubber ring (O).
- Shower kit (GD) for pre-rinsing tables.

Entry / exit tables

	MODEL	CODE	TO PLACE ON THE	EQUIPMENT (*)	DIMENSION (mm)	€
	MP-620-I	19053197	Left	P - E	620x740x880	-
	MP-620-D	19053199	Right	P - E	620x740x880	-
	MLP-1200-I E-VO	19058358	Left	P - E	1.200x740x880	-
	MLP-1200-D E-VO	19058359	Right	P - E	1.200x740x880	-

(*): E: Lower rack / P: Removable splashback

Union element for hood dishwashers

	MODEL	CODE	DESCRIPTION	DIMENSION (mm)	€
	MP-140	19061430	Element for joining two hood dishwasher in series	140x740x350	-

Prewashing tables

- Worktop 1,5 mm thick.
- Lower rack 1 mm thick
- Sink welded to the countertop
- Lower rack welded, not removable
- 4 welded legs, not removable

	MODEL	CODE	TO PLACE ON THE	EQUIPMENT (*)	DIMENSION (mm)	€
	MF-700-I E-VO	19059285	Left	P - E - F	700x740x880	-
	MF-700-D E-VO	19059286	Right	P - E - F	700x740x880	-
	MF-1200-I E-VO	19059287	Left	P - E - F	1.200x740x880	-
	MF-1200-D E-VO	19059288	Right	P - E - F	1.200x740x880	-
	MFD-1200-I E-VO	19059289	Left	P - E - F - O	1.200x740x880	-
	MFD-1200-D E-VO	19059290	Right	P - E - F - O	1.200x740x880	-
	MFD-1500-I E-VO	19059291	Left	P - E - F - O	1.500x740x880	-
	MFD-1500-D E-VO	19059292	Right	P - E - F - O	1.500x740x880	-

(*): E: Lower rack / P: Splashback / F: Bowl / O: Waste scraping hole.

THE TAP IS NOT INCLUDED WITH THE TABLES.
See available taps in the static preparation section.

Examples of assembly



AD-125 + MP-620-I + MP-620-D



CO-110 + MF-700-I + GD2 E + MLP-1200-D



CO-142 + CO+142 +
MLP-1200-I E-VO + MP-140 + MFD-1200-D E-VO
SERIES ASSEMBLY OF TWO HOOD DISHWASHER

MODELO	CODE	DESCRIPTION	€
REPLACEMENT KIT	19059308	Kit of elements to adapt the old tables to a 2019 hood dishwasher	-

Schemes of different types of assembly

Linear assembly

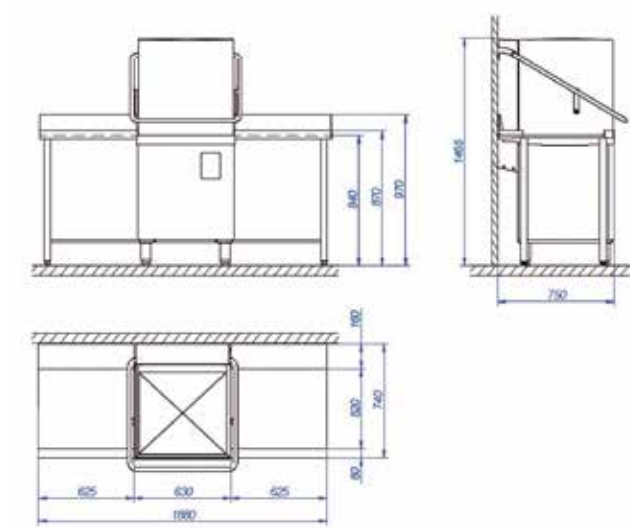

Assembly in corner

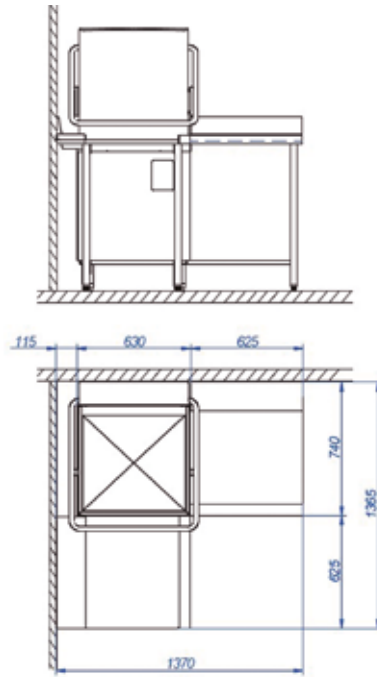

Kits to transform

Kit to transform the basic versions

MODEL	CODE	DESCRIPTION	€
 DD 	19059327	PERISTALTIC DETERGENT DOSER	-
 B-CAP 	19059326	KIT DRAIN PUMP HOOD TYPE	-

Optional marine kit for ships

MODEL	CODE	VALID FOR	CHARACTERISTICS	€
KIT MARINE HOOD	19036059	AD-125, COP-144, CO-142, CO-110	Connection for ships 440V	-



Robust and powerful
for high degrees of
cleanliness.



Find out more!



Access the website

Utensilwashers

Utensilwashers LP Series	238
Utensilwashers LP-ECO Series	238
Accessories	238

Water connection:
It is advisable to introduce sanitary water in the dishwashers, with a temperature of 50 - 60 °C.

Water pressure:
Minimum: 2 bar = 2 kg/cm²
Maximum: 4 bar = 4 kg/cm²

Water softener:
All glass / dishwashers should be connected to a treated water supply when the local supply is over 10 HF / 6 HD.

Any issues derived from a bad installation that don't meet with the indicated conditions will not be considered as a warranty.

Utensilwashers



General characteristics

LP SERIES

- LP Series for the cleaning of utensils and kitchen recipients.
- Made with double skinned of stainless steel 18/10 (AISI-304).
- Electronic control panel.
- Rotating wash and rinse arms.
- Wash temperature 55°C and rinse 80°C.
- Wash cycles: 2' - 4' - 6'.
- Continuous wash cycle up to 12'.

- Maximum theoretical productivity: 30 racks/hour.
- Thermostop system.
- Control of the rinse pressure.
- Built-in detergent dispenser and rinse dispenser.
- Electric connection: 400 V - III+N+E - 50 Hz.
- Thanks to the drain pump, the self-cleaning cycle is automatic.
- Rinsing pump that guarantees a perfect hygienic result and constant pressure control during the rinse.
- DD: Detergent dispensers and

brightener included.

- B: Drain pump included.

LP-ECO SERIES

- Similar features, except:
 - Do not include a built-in drain pump.
 - Without control of rinse pressure.
 - Without detergent dispenser.
 - Without self cleaning cycle.
- Fixed cycles duration: 2' - 4' - 8'.



MODEL	CODE	BASKET SIZE (mm)	USABLE HIGHT (mm)	TANK CAPACITY (L)	WATER CONSUMPTION (L/BASKETS)	POWER (KW)	DIMENSIONS (mm)	€
LP-SERIES								
LP-61 B DD	19076870	500x600	400	23	3	6,7	600x700x1.230	-
LP-62 B DD	19076872	560x630	650	37	3	7,5	720x780x1.730	-
LP-62 B DD HRS	19076873	560x630	650	37	3	7,5	720x780x1.960	-
LP-63 B DD	19072567	560x630	850	37	3	7,5	720x780x1.930	-
LP-63 B DD HRS	19076875	560x630	850	37	3	7,5	720x780x2.160	-
LP-70 B DD	19075071	700x700	850	68	4	10,7	850x860x1.960	-
LP-70 B DD HRS	19076876	700x700	850	68	4	10,7	850x850x2.160	-
LP-130 B DD	19074725	1.320x700	850	131	6	15,9	1.470x850x1.960	-
LP-130 B DD HRS	19076877	1.320x700	850	131	6	15,9	1.470x850x2.160	-
LP-SERIES ECO								
LP-61 DD ECO	19003005	500x600	400	23	3	6,7	600x700x1.230	-
LP-62 DD ECO	19003006	560x630	650	37	3	7,5	719x780x1.730	-

Accessories supplied: One basket.

Accessories for utensilwashers

MODEL	CODE	DESCRIPTION	€
CT-LP61B	19023165	Basket for LP-61 B	-
CT-LP62	19010251	Basket for LP-62 and LP-63 H	-
CT-LP70	19010252	Basket for LP-70	-
CT-LP130	19011085	Basket for LP-130	-
SMP	19010253	Support for pastry dispenser	-
ARM8	19010254	Frame support for 8 trays	-
CU150	19010255	Cutlery container (150 x 150 mm)	-



Robust and reliable machines, with an increased output capacity.



Find out more!



Access the website



Comercial video



Sales brochure

Rack conveyor

Compact dishwashers	241
Modular dishwashers.....	246
Accessories	253

Water connection:
It is advisable to introduce sanitary water in the dishwashers, with a temperature of 50 - 60 °C.

Water pressure:
Minimum: 2 bar = 2 kg/cm²
Maximum: 4 bar = 4 kg/cm²

Water softener:
All glass / dishwashers should be connected to a treated water supply when the local supply is over 10 HF / 6 HD.

Any issues derived from a bad installation that don't meet with the indicated conditions will not be considered as a warranty.

Rack conveyor | Compact dishwashers



General characteristics

- All the main parts are manufactured in AISI-304 anti-corrosion stainless steel: tanks, washing and rinsing arms, rinsing jets, doors, basket conveyance system, boiler and metal tubes.
- Upwards-opening double panel door.
- Tank tray filters made of AISI-304 stainless steel, easy to access and remove for cleaning and access to the tank.
- Safety filter for pump suction.
- Rinsing boiler with heat insulation.
- Easy access for installation. Electrovalve located on one side (no need to remove panels to connect the machine).
- Electrical panel designed for easy connection of dosers for liquid and solid detergents, rinse aid, limit switches, supplementary emergency stop button.
- Washing arms easily removable as a set, for cleaning, with a plug on each branch providing access for cleaning inside.
- Rinse jets easily dismountable and removable.
- System of electronic regulation of speeds by means of frequency shifter.
- Configurable electronic temperature control:
 - Wash (50 - 65 °C)
 - Rinse (70 - 85 °C)
 - Guarantor of rinse at 85 °C.
- Pressure regulator for flow control.
- Emergency stop button incorporated.
- Extra anti-entrapment protection system at the entrance, mounted on the AS-260 splash guard supplement (optional).
- Open door blocking system.
- IPX4 protection system.
- System for detection of blockage of conveyor carriage and automatic reverse function.
- High-power washing system with 4 upper and 4 lower washing branches.
- 3 washing programs: deep, medium and high-capacity.
- Double effect rinse.
- Energy-saving system: reduces consumption by halting operation of the pumps, and by passing the heating of the rinse to stand-by mode (70 °C).
- Auto-timer which deactivates the conveyor motor after a pre-set period of inactivity (10 minutes).
- Energy saving system in the wash: the wash does not start up until it detects the passage of the basket.
- Rinse saving system. The rinse stops when the basket has left, saving water and energy.
- Limit switch included.

Equipment included:

- 2 base baskets, CT-10
- 2 baskets for plates CP-16/18, 1 basket for glasses CV-16/105, 1 basket for cutlery CT-10 R

MODEL	HZ.	CODE	ENTRANCE (*)	WATER SUPPLY	PROGRAMS (BASKETS/H)			INTERNAL ZONES (**)	WATER CONSUMPTION (L/H)	ELECTRICAL POWER (kW)	DIMENSIONS (mm)	€
					DEEP	MEDIUM	HIGH-CAPACITY					
CCO-120-L- HW	50	19048203	L	>50°	80	100	120		210	19.45	1,180 x 790 x 1,550	-
	60	19048571										
CCO-120-R- HW	50	19048204	R	>50°	80	100	120	LP + A	210	19.45	1,180 x 790 x 1,550	-
	60	19048573										
CCO-120-L- CW	50	19045325	L	<50°	80	100	120		210	28.45	1,180 x 790 x 1,550	-
	60	19048217										
CCO-120-R- CW	50	19046527	R	<50°	80	100	120	LP + A	210	28.45	1,180 x 790 x 1,550	-
	60	19047158										

(*) Entry of baskets:
L: Entrance from the Left of the machine.
R: Entrance from the Right of the machine.

(**) Internal zones

Rack conveyor | Compact dishwashers



General characteristics

- All the main parts are manufactured in AISI-304 anti-corrosion stainless steel: tanks, washing and rinsing arms, rinsing jets, doors, basket conveyance system, boiler and metal tubes.
- Upwards-opening double panel door.
- Tank tray filters made of AISI-304 stainless steel, easy to access and remove for cleaning and access to the tank.
- Safety filter for pump suction.
- Rinsing boiler with heat insulation.
- Easy access for installation. Electrovalve located on one side (no need to remove panels to connect the machine).
- Electrical panel designed for easy connection of dosers for liquid and solid detergents, rinse aid, limit switches, supplementary emergency stop button.
- Washing arms easily removable as a set, for cleaning, with a plug on each branch providing access for cleaning inside.
- Rinse jets easily dismantlable and

- removable.
- System of electronic regulation of speeds by means of frequency shifter.
- Configurable electronic temperature control:
 - Wash (50 - 65 °C)
 - Rinse (70 - 85 °C)
 - Guarantor of rinse at 85 °C.
 - Pressure regulator for flow control.
 - Emergency stop button incorporated.
- Extra anti-entrapment protection system at the entrance, mounted on the AS-260 splash guard supplement (optional).
- Open door blocking system.
- IPX4 protection system.
- System for detection of blockage of conveyor carriage and automatic reverse function.
- High-power washing system with 4 upper and 4 lower washing branches.
- 3 washing programs: deep, medium and high-capacity.

- Double effect rinse.
- Energy-saving system: reduces consumption by halting operation of the pumps, and by passing the heating of the rinse to stand-by mode (70 °C).
- Auto-timer which deactivates the conveyor motor after a pre-set period of inactivity (10 minutes).
- Energy saving system in the wash: the wash does not start up until it detects the passage of the basket.
- Rinse saving system. The rinse stops when the basket has left, saving water and energy.
- Limit switch included.

Equipment included:

- 2 base baskets, CT-10
- 2 baskets for plates CP-16/18, 1 basket for glasses CV-16/105, 1 basket for cutlery CT-10 R

MODEL	HZ.	CODE	ENTRANCE (*)	WATER SUPPLY	PROGRAMS (BASKETS/H)			INTERNAL ZONES (**)	WATER CONSUMPTION (L/H)	ELECTRICAL POWER (kW)	DIMENSIONS (mm)	€
					DEEP	MEDIUM	HIGH-CAPACITY					
CCO-160-L-HW	50	19048233	L	>50°	100	130	160		240	22.45	1,180 x 790 x 1,550	-
	60	19048576										
CCO-160-R-HW	50	19048255	R	>50°	100	130	160	LP + A	240	22.45	1,180 x 790 x 1,550	-
	60	19048579										
CCO-160-L-CW	50	19048231	L	<50°	100	130	160		240	31.45	1,180 x 790 x 1,550	-
	60	19048575										
CCO-160-R-CW	50	19048254	R	<50°	100	130	160	LP + A	240	31.45	1,180 x 790 x 1,550	-
	60	19048578										

(*) Entry of baskets:
L: Entrance from the Left of the machine.
R: Entrance from the Right of the machine.

(**)
Internal zones
LP: Main wash.
A: Double effect rinse.
A-ECO: Double ECO effect rinse.

Concept | Compact dishwasher “eco” version - gas heated



General characteristics

- The ECO version conveyor dishwashers are fitted with an external hot water generator, gas heated, model GWB-40 (*).
- The generator replaces the electric rinse boiler in the dishwasher, bringing a significant saving in electricity consumption.
- Given the heating power of the generator, the dishwasher can be installed in facilities with a cold water connection.
- The dishwasher has a motor pump to send the water from the generator to the rinse jets.
- The dishwasher incorporates a flow regulator to ensure constant water consumption.
- The first filling of the dishwasher wash tank takes place with water from the generator, rapidly reaching the set temperature.

MODEL	HZ.	CODE (#)	ENTRANCE (*)	WATER SUPPLY	PROGRAMS (BASKETS/H)			INTERNAL ZONES (**)	WATER CONSUMPTION (L/H)	ELECTRICAL POWER (kW)	GAS POWER (kW)	DIMENSIONS (mm)	€
					DEEP	MEDIUM	HIGH-CAPACITY						
	CCO-120-L-ECO	50 19046991	L	<50°	80	100	120		210	10.7	48	1,180 x 790 x 1,550	-
		60 19048572											
	CCO-120-R-ECO	50 19046990	R	<50°	80	100	120		210	10.7	48	1,180 x 790 x 1,550	-
		60 19048574											
	CCO-160-L-ECO	50 19048253	L	<50°	100	130	160		240	10.7	48	1,180 x 790 x 1,550	-
		60 19048577											
	CCO-160-R-ECO	50 19048256	R	<50°	100	130	160		240	10.7	48	1,180 x 790 x 1,550	-
		60 19048580											

(#) Note on codes
When placing your order, to the machine code, please add the generator code GWB-40, according to the type of gas and electrical frequency (see table on the following page), included in the price.

(*) Entry of baskets:
L: Entrance from the Left of the machine.
R: Entrance from the Right of the machine.

(**) Internal zones
■ LP: Main wash.
■ A-ECO: Double effect rinse.



	COMPOSICIÓN		MODEL	CÓDIGO
	Model	Code		
Dishwasher	CCO-120-I-CW	19045325		
Anti-salp.	AS-260	19048568	CCO-120 PACK I CW	19068300
Drying tunnel	CDT-600	19046516		
Dishwasher	CCO-120-D-CW	19046527		
Anti-salp.	AS-260	19048568	CCO-120 PACK D CW	19068304
Drying tunnel	CDT-600	19046516		
Dishwasher	CCO-160-I-CW	19048231		
Anti-salp.	AS-260	19048568	CCO-160 PACK I CW	19068305
Drying tunnel	CDT-600	19046516		
Dishwasher	CCO-160-D-CW	19048254		
Anti-salp.	AS-260	19048568	CCO-160 PACK D CW	19068306
Drying tunnel	CDT-600	19046516		

MODEL	CODE	ENTRANCE	HZ	PRODUCTION		WATER Lit/ cycle	POWER MÁX (kW)	DIMENSIONS (mm)	€
				Speed No.	Baskets/h				
CCO-120 PACK I CW	19068300	IZQ	50	3	120	210	38,00	2.040x790x1.930	-
CCO-120 PACK D CW	19068304	DCHA	50	3	120	210	38,00	2.040x790x1.930	-
CCO-160 PACK I CW	19068305	IZQ	50	3	160	240	41,00	2.040x790x1.930	-
CCO-160 PACK D CW	19068306	DCHA	50	3	160	240	41,00	2.040x790x1.930	-

Complementary modules for compact conveyor dishwashers

Options in-factory assembly on demand

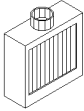
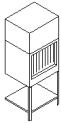
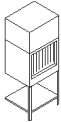
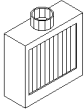
MODEL	CODE	DESCRIPTION	POWER (KW)	DIMENSIONS (mm)	€
 AS-260	19048568	ANTI-SPLASH GUARD SUPPLEMENT (ENTER) With fitting for connection of fume extractor. With separator curtains. Includes extra anti-entrapment protection element. Fitted as standard at the entrance of modular dishwashers.	-	L = 260 mm	-
 CDT-600	19046516	DRYING TUNNEL Supplementary element with 9 kW heating element box and upper fan for drying of the dishes with 0.55 kW motor. Module with conveyance system included, for placement at the end of the machine. With separator curtains. Bottom shelf.	9,55	600x790x1.930	-
 CRS-600	19048639	CONVEYOR RECOVERY SYSTEM Recommended for models with cold water input (CW) Aspires the steam generated inside the tunnel and sends the condensed water to the tank of the machine, increasing the water temperature from 15/18 °C to 35/40 °C. Allows savings of up to 3 kW-h. Recommended for models with cold water input (CW) with temperatures no higher than 25 °C. It is not appropriate for installation in machines with hot water input, nor in ECO models with rinse water heating in the GWB-40 generator. Module with conveyance system included. With separator curtains. Bottom shelf.	0,75	600x790x1.930	-
 ASE-260	19076633	ANTI-SPLASH GUARD SUPPLEMENT (EXIT) With fitting for connection of fume extractor. With separator curtains. Includes extra anti-entrapment protection element. Optional on all compact or modular rack-type dishwashers. This item cannot be installed on dishwashers fitted with CDT drying.	-	L = 260 mm	-

Transformations to other voltages

VOLTAGE	CHARACTERISTICS	€
Supplement for MARINE version	Connection for ships (440 V - 60 Hz)	-
Supplement for 230 V 3 ~ version	230 V 3 ~	-



Rack conveyor | Modular dishwashers



General Characteristics

- All the main parts are manufactured in AISI-304 anti-corrosion stainless steel: tanks, washing and rinsing arms, rinsing jets, doors, basket conveyance system, boiler and metal tubes.
- Upwards-opening double panel door.
- Tank tray filters made of AISI-304 stainless steel, easy to access and remove for cleaning and access to the tank.
- Safety filter for pump suction.
- Rinsing boiler with heat insulation.
- Easy access for installation. Electrovalve located on one side (no need to remove panels to connect the machine).
- Electrical panel designed for easy connection of dosers for liquid and solid detergents, rinse aid, limit switches, supplementary emergency stop button.
- Washing arms easily removable as a set, for cleaning, with a plug on each branch providing access for cleaning inside.
- Rinse jets easily dismountable and removable.
- System of electronic regulation of speeds by means of frequency shifter.
- Configurable electronic temperature control:
 - Wash (50 - 65 °C)
 - Rinse (70 - 85 °C)
 - Guarantor of rinse at 85 °C.
 - Pressure regulator for flow control.
 - Emergency stop button incorporated.
 - Extra anti-entrapment protection system at the entrance, mounted on the AS-260 splash guard supplement, as standard.
 - Open door blocking system.
 - IPX4 protection system.
 - System for detection of blockage of conveyor carriage and automatic reverse function.
 - Prewash module with 3 upper and 3 lower washing branches.
 - High-power washing system with 5 upper and 5 lower washing branches.
 - 3 washing programs: intensive (DIN10534), medium and high-capacity.
 - Rinse and pre-rinse, both double effect, in models 180, 225 and 270.
- Double-effect rinse and triple-effect pre-rinse in model 320.
- Energy-saving system: reduces consumption by halting operation of the pumps, and by passing the heating of the rinse to stand-by mode (70 °C).
- Auto-timer which deactivates the conveyor motor after a pre-set period of inactivity (10 minutes).
- Energy saving system in the wash: the wash does not start up until it detects the passage of the basket.
- Rinse saving system. The rinse stops which the basket has left, saving water and energy.
- Limit switch included.

Equipment included:
 2 base baskets, CT-10
 2 baskets for plates CP-16/18, 1 basket for glasses CV-16/105, 1 basket for cutlery CT-10 R

MODEL	HZ.	CODE	ENTRANCE	WATER SUPPLY	PROGRAMS (BASKETS/H)			MODULES CONSUMPTION (**)	WATER CONSUMPTION (L/H)	ELECTRICAL POWER (KW)	DIMENSIONS (mm)	€
					INTENSIF	MEDIUM	HIGH-CAPACITY					
CCO-180-L-HW	50	19048582	L	>50°	90	135	180		210	25.7	1,750 x 790 x 1,550	-
	60	19048583										
CCO-180-R-HW	50	19048587	R	>50°	90	135	180		210	34.7	1,750 x 790 x 1,550	-
	60	19048588										
CCO-180-L-CW	50	19047209	L	<50°	90	135	180		210	35.9	2,360 x 790 x 1,550	-
	60	19048581										
CCO-180-R-CW	50	19047164	R	<50°	90	135	180		210	44.9	2,360 x 790 x 1,550	-
	60	19051473										
CCO-225-L-HW	50	19048595	L	>50°	125	175	225		210	35.9	2,360 x 790 x 1,550	-
	60	19048596										
CCO-225-R-HW	50	19048212	R	>50°	125	175	225		210	44.9	2,360 x 790 x 1,550	-
	60	19048600										
CCO-225-L-CW	50	19048119	L	<50°	125	175	225		210	44.9	2,360 x 790 x 1,550	-
	60	19048594										
CCO-225-R-CW	50	19048120	R	<50°	125	175	225		210	44.9	2,360 x 790 x 1,550	-
	60	19048599										

(*) Entry of baskets:
 L: Entrance from the Left of the machine.
 R: Entrance from the Right of the machine.

(**) COMPOSITION OF MODULES

The diagrams and composition indicated always refer to the left-entry version.

- AS-260: Anti-splash guard supplement
- PL3: Cold water prewash
- PL5: First Wash with cold water
- L5: First wash with hot water
- LP: Main wash
- DA: Double-effect rinse and pre-rinse
- TA: Double-effect rinse and triple-effect pre-rinse

Rack conveyor | Modular dishwashers



General Characteristics

- All the main parts are manufactured in AISI-304 anti-corrosion stainless steel: tanks, washing and rinsing arms, rinsing jets, doors, basket conveyance system, boiler and metal tubes.
- Upwards-opening double panel door.
- Tank tray filters made of AISI-304 stainless steel, easy to access and remove for cleaning and access to the tank.
- Safety filter for pump suction.
- Rinsing boiler with heat insulation.
- Easy access for installation. Electrovalve located on one side (no need to remove panels to connect the machine).
- Electrical panel designed for easy connection of dosers for liquid and solid detergents, rinse aid, limit switches, supplementary emergency stop button.
- Washing arms easily removable as a set, for cleaning, with a plug on each branch providing access for cleaning inside.
- Rinse jets easily dismantlable and removable.
- System of electronic regulation of speeds by means of frequency shifter.
- Configurable electronic temperature control:
 - Wash (50 - 65 °C)
 - Rinse (70 - 85 °C)
 - Guarantor of rinse at 85 °C.
- Pressure regulator for flow control.
- Emergency stop button incorporated.
- Extra anti-entrapment protection system at the entrance, mounted on the AS-260 splash guard supplement, as standard.
- Open door blocking system.
- IPX4 protection system.
- System for detection of blockage of conveyor carriage and automatic reverse function.
- Prewash module with 3 upper and 3 lower washing branches.
- High-power washing system with 5 upper and 5 lower washing branches.
- 3 washing programs: intensive (DIN10534), medium and high-capacity.
- Rinse and pre-rinse, both double effect, in models 180, 225 and 270.
- Double-effect rinse and triple-effect pre-rinse in model 320.
- Energy-saving system: reduces consumption by halting operation of the pumps, and by passing the heating of the rinse to stand-by mode (70 °C).
- Auto-timer which deactivates the conveyor motor after a pre-set period of inactivity (10 minutes).
- Energy saving system in the wash: the wash does not start up until it detects the passage of the basket.
- Rinse saving system. The rinse stops when the basket has left, saving water and energy.
- Limit switch included.

Equipment included:
 2 base baskets, CT-10
 2 baskets for plates CP-16/18, 1 basket for glasses CV-16/105, 1 basket for cutlery CT-10 R

MODEL	HZ.	CODE	ENTRANCE	WATER SUPPLY (*)	PROGRAMS (BASKETS/H)			MODULES CONSUMPTION (**)	WATER CONSUMPTION (L/H)	ELECTRICAL POWER (KW)	DIMENSIONS (mm)	€
					INTENSIF	MEDIUM	HIGH-CAPACITY					
CCO-270-L-HW	50	19048608	L	>50°	140	205	270		240	39,9	2,660 x 790 x 1,550	-
60	19048609											
CCO-270-R-HW	50	19048614	R	>50°	140	205	270		240	48,9	2,660 x 790 x 1,550	-
60	19048615											
CCO-270-L-CW	50	19048606	L	<50°	140	205	270		240	47,1	3,260 x 790 x 1,550	-
60	19048607											
CCO-270-R-CW	50	19048612	R	<50°	140	205	270		240	56,1	3,260 x 790 x 1,550	-
60	19048613											
CCO-320-L-HW	50	19048621	L	>50°	170	245	320		240	47,1	3,260 x 790 x 1,550	-
60	19048622											
CCO-320-R-HW	50	19048630	R	>50°	170	245	320		240	56,1	3,260 x 790 x 1,550	-
60	19048631											
CCO-320-L-CW	50	19048618	L	<50°	170	245	320		240	56,1	3,260 x 790 x 1,550	-
60	19048620											
CCO-320-R-CW	50	19048627	R	<50°	170	245	320		240	56,1	3,260 x 790 x 1,550	-
60	19048628											

(*) Entry of baskets:
 L: Entrance from the Left of the machine.
 R: Entrance from the Right of the machine.

(**) COMPOSITION OF MODULES
 The diagrams and composition indicated always refer to the left-entry version.

- AS-260: Anti-splash guard supplement
- PL3: Cold water prewash
- PL5: First Wash with cold water
- L5: First wash with hot water
- LP: Main wash
- DA: Double-effect rinse and pre-rinse
- TA: Double-effect rinse and triple-effect pre-rinse

Concept modular | Dishwashers “ECO” version - gas heated



Specific characteristics

- The ECO version conveyor dishwashers are fitted with an external hot water generator, gas heated, model GWB-40 (*).
- The generator replaces the electric rinse boiler in the dishwasher, bringing a significant saving in electricity consumption.
- Given the heating power of the generator, the dishwasher is for installation in facilities with a cold water connection.
- The dishwasher has a motor pump to send the water from the generator to the rinse jets.
- The dishwasher incorporates a flow regulator to ensure constant water consumption.
- The first filling of the dishwasher wash tank takes place with water both from the generator and from the filling electrovalve.

MODEL	HZ.	CODE (*)	ENTRANCE WATER	PROGRAMS (BASKETS/H)			MODULES CONSUMPTION (#)	WATER CONSUMPTION (L/H)	ELECTRICAL POWER (KW)	GAS POWER (KW)	DIMENSIONS (mm)	€
				RED	INTENSIF	MEDIUM						
CCO-180-L-ECO	50	19048584	L	<50°	90	135	180	210	19,7	48	1.750 x 790 x 1.550	-
	60	19048586										
CCO-180-R-ECO	50	19048591	R	<50°	90	135	180	210	19,7	48	1.750 x 790 x 1.550	-
	60	19048593										
CCO-225-L-ECO	50	19048597	L	<50°	125	175	225	210	20,9	48	2.360 x 790 x 1.550	-
	60	19048598										
CCO-225-R-ECO	50	19048602	R	<50°	125	175	225	210	20,9	48	2.360 x 790 x 1.550	-
	60	19048603										
CCO-270-L-ECO	50	19048610	L	<50°	140	205	270	240	21,9	48	2.660 x 790 x 1.550	-
	60	19048611										
CCO-270-R-ECO	50	19048616	R	<50°	140	205	270	240	21,9	48	2.660 x 790 x 1.550	-
	60	19048617										
CCO-320-L-ECO	50	19048624	L	<50°	170	245	320	240	29,1	48	3.260 x 790 x 1.550	-
	60	19048626										
CCO-320-R-ECO	50	19048633	R	<50°	170	245	320	240	29,1	48	3.260 x 790 x 1.550	-
	60	19048636										

(#) Note on codes
When placing your order, to the machine code, please add the generator code GWB-40, according to the type of gas and electrical frequency (see table on the following page), included in the price.



(*) Entry of baskets:
L: Entrance from the Left of the machine.
R: Entrance from the Right of the machine.

(**) COMPOSITION OF MODULES
The diagrams and composition indicated always refer to the left-entry version.

- AS-260: Anti-splash guard supplement
- PL3: Cold water prewash
- PL5: First Wash with cold water
- L5: First wash with hot water
- LP: Main wash
- DA: Double-effect rinse and pre-rinse
- TA: Double-effect rinse and triple-effect pre-rinse

Complementary modules for modular conveyor dishwashers

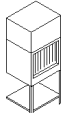
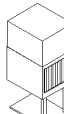
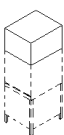
Options in-factory assembly on demand

MODEL	CODE	DESCRIPTION	POWER (KW)	DIMENSIONS (mm)	€
 CDT-600	19046516	DRYING TUNNEL Specially for modular models 180 and 225. Supplementary element with 9 kW heating element box and upper fan for drying of the dishes with 0.55 kW motor. Module with conveyance system included, for placement at the end of the machine. With separator curtains. Bottom shelf.	9,55	600x790x1.930	-
 CDT-800	19047215	EXTRA DRYING TUNNEL Specially for modular models 270 and 320. Supplementary element with 13.5 kW heating element box and upper fan for drying of the dishes with 1.1 kW motor. Module with conveyance system included, for placement at the end of the machine. With separator curtains. Bottom shelf.	14,6	800x790x1.930	-
 (#) CRS-700-I CRS-700-D	19056031 19048641	UPPER ENERGY RECYCLER Recommended for models with cold water input (CW). Aspires the steam generated inside the tunnel and sends the condensed water to the tank of the machine, increasing the water temperature from 15/18 °C to 35/40 °C. Allows savings of up to 3 kW-h. Fitted into the top of the dishwasher. Does not increase length. Recommended for models with cold water input (CW) with temperatures no higher than 25 °C. It is not appropriate for installation in machines with hot water input, nor in ECO models with rinse water heating in the GWB-40 generator.	0,55	600x790x500	-
 ASE-260	19076633	ANTI-SPLASH GUARD SUPPLEMENT (EXIT) With fitting for connection of fume extractor. With separator curtains. Includes extra anti-entrapment protection element. Optional on all compact or modular rack-type dishwashers. This item cannot be installed on dishwashers fitted with CDT drying.	-	L = 260 mm	-

(*) Entry of baskets:
L: Entrance from the Left of the machine.
R: Entrance from the Right of the machine.

Transformations to other voltages

VOLTAGE	CHARACTERISTICS	€
Supplement for MARINE version	Connection for ships (440 V - 60 Hz)	-
Supplement for 230 V 3 ~ version	230 V 3 ~	-





Summary of characteristics of the different modules

Table of modules which can form part of the composition of the modular conveyance trains.

The composition of the different models is indicated on the previous pages.

MODULE		CCO-120	CCO-160	CCO-180	CCO-225	CCO-270	CCO-320
Supplementary Anti-splash + anti-entrapment protection at the entrance	AS-260	•	•	•	•	•	•
Prewash	PL3	-	-	-	•	-	•
Intense prewash	PL5	-	-	-	-	•	-
First wash	L5	-	-	-	-	-	•
Main wash	LP	•	•	•	•	•	•
Double effect rinse	A	•	•	-	-	-	-
Double effect ECO rinse	A-ECO	•	•	-	-	-	-
Double effect pre-rinse + Double effect rinse	DA	-	-	•	•	•	-
Double effect pre-rinse + Double effect ECO rinse	DA-ECO	-	-	•	•	•	-
Triple effect pre-rinse + Double effect rinse	TA	-	-	-	-	-	•
Triple effect pre-rinse + Double effect ECO rinse	DA / TA-ECO	-	-	-	-	-	•
Drying Module 600	CDT-600	•	•	•	•	-	-
Drying Module 800	CDT-800	-	-	-	-	•	•
Energy recycler for compact models	CRS-600	•	•	-	-	-	-
Energy recycler for modular dishwashers	CRS-700	-	-	•	•	•	•
Supplementary anti-splash guard at the exit	AS-260	•	•	•	•	•	•

All the modular machines come with an anti-splash module AS-260 at the entrance as standard, 260 mm in length.
An exterior extractor can be fitted to this module.
Optionally, you can also request it as a supplement to fit to the exit of the machine.
The CDT drying tunnels are fitted to the exit of the machine, increasing the total length by 600 or 800 mm (depending on the model of drying tunnel installed). For models 270 and 320, the extra CDT-800 drying tunnel is to be installed.



The CRS-700 energy recycler is to be placed on top of the modular dishwashers, and the total length is not increased. Recommended for models with cold water input (CW) with temperatures no higher than 25 °C. It is not appropriate for installation in machines with hot water input, nor in ECO models with rinse water heating in the GWB-40 generator.
The mission of this accessory is to collect the steam from the inside of the dishwasher, and, after a process of condensation, send this water (which is at high temperature) to the rinse system. This raises the average temperature in the rinse system, which therefore requires a lower supply of electrical energy, contributing to notable savings in energy and costs (around 3 kW-h).

Kits and accessories for manufactured machines

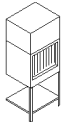
For compact conveyor dishwashers

MODEL	CODE	DESCRIPTION	POWER (KW)	DIMENSIONS (mm)	€
	KIT CDT-600 MODULE L	DRYING TUNNEL Supplementary element with 9 kW heating element box and upper fan for drying of the dishes with 0.55 kW motor. Module with conveyance system included, for placement at the end of the machine. With separator curtains. Bottom shelf.	9,55	600x790x1.930	-
	19056095				
	KIT CDT-600 MODULE R				
	19086106				

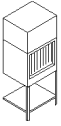
For modular conveyor dishwasher

MODEL	CODE	DESCRIPTION	POWER (KW)	DIMENSIONS (mm)	€
	KIT CDT-600 MODULE L	DRYING TUNNEL Supplementary element with 9 kW heating element box and upper fan for drying of the dishes with 0.55 kW motor. Module with conveyance system included, for placement at the end of the machine. With separator curtains. Bottom shelf.	9,55	600x790x1.930	-
	19056095				
	KIT CDT-600 MODULE R				
	19086106				
	CDT-800	EXTRA DRYING TUNNEL Specially for modular models 270 and 320. Supplementary element with 13.5 kW heating element box and upper fan for drying of the dishes with 1.1 kW motor. Module with conveyance system included, for placement at the end of the machine. With separator curtains. Bottom shelf.	14,6	800x790x1.930	

For "ECO" version-gas heated

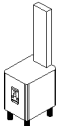
MODEL	CODE	DESCRIPTION	POWER (KW)	DIMENSIONS (mm)	€
	GWB-40	GAS HOT WATER GENERATOR Forced draught burner and double safety valve. Electronic control of temperature and water levels. Automatic limescale removal. Automatic tank emptying.	40,00	432x548x770	-

Summary table of characteristics for conveyor dishwashers

	CCO-120	CCO-160	CCO-180	CCO-225	CCO-270	CCO-320
SPEEDS	3	3	3	3	3	3
PRODUCTION (baskets/h)						
Deep wash program	80	100	-	-	-	-
Intensive program (DIN-10534)	-	-	90	125	140	170
Medium program	100	130	135	175	225	245
High-capacity program	120	160	180	225	270	320
PREWASH PL3,PL5						
Tank capacity (l)	-	-	-	60	100	60
Pump power (kW)	-	-	-	1,2	2,2	1,2
WASH L5, LP						
Tank capacity (l)	50	50	100	100	100	200
Temperature (°C)	55-65	55-65	55-65	55-65	55-65	55-65
Heating power (kW)	9	9	12	12	12	18
Pump power (kW)	1.2	1.2	2.2	2.2	2,2	4.4
PRE-RINSE DA, TA						
Tank capacity (l)	-	-	15	15	15	15
Temperature (°C)	-	-	70	70	70	70
Heating power (kW)	-	-	5	5	5	5
Pump power (kW)	-	-	0.26	0.26	0.26	0.26
RINSE						
Boiler volume (l)	21	21	21	21	21	21
Temperature (°C)	80-85	80-85	80-85	80-85	80-85	80-85
Heating power (kW)						
CW	27	30	27	24	27	27
CW with recycler	24	27	24	21	24	24
HW	18	21	18	15	18	18
ECO	-	-	-	-	-	-
ECO rinse pump power (kW)	0,26	0,26	0,26	0,26	0,26	0,26
Water consumption 1						
(l/h)	210	240	210	210	240	240
(l/basket)	1.75	1.5	1.17	0.93	0.89	0.75
STANDARD CONNECTION						
Type of connection (default)	ALT.	ALT.	ALT.	SIM.	SIM.	SIM.
Voltage 2	400 V /3N ~ / 50 - 60Hz					
TOTAL POWER (kW)						
CW	28.5	31.5	34.7	44.9	48.9	56.1
CW with recycler	26.2	29.2	32.3	42.5	46.5	53.7
HW	19.5	22.5	25.7	35.9	39.9	47.1
ECO	10.7	10.7	19.7	20.9	21.9	29.1
ECO gas booster (gas kW)	38	38	38	38	38	38
WIDTH (mm)						
Standard	1180	1180	1750	2360	2660	3260
With entrance module	1440	1440	1760	2360	2660	3260
With drying module	1780	1780	2100	2700	3200	3800
DEPTH (mm)						
Standard	790	790	790	790	790	790
HEIGHT (mm) 3						
Standard	1550-1610	1550-1610	1550-1610	1550-1610	1550-1610	1550-1610
With drying	1860-1920	1860-1920	1860-1920	1860-1920	1860-1920	1860-1920
With recycler	1960-2020	1960-2020	1960-2020	1960-2020	1960-2020	1960-2020
With open door blocking system	1870-1930	1870-1930	1870-1930	1870-1930	1870-1930	1870-1930
OPERATING HEIGHT (mm)						
Standard	850-900	850-900	850-900	850-900	850-900	850-900
USEFUL ENTRANCE HEIGHT (mm)						
Standard	390	390	390	390	390	390
PASSAGE WIDTH (mm)						
Standard	510	510	510	510	510	510
WEIGHT (KG)						
Net	211	211	259	381	434	556
Gross	305	305	382	556	628	792
WATER CONNECTION						
Operating pressure	2 - 4 bars					
Type of connection	3/4" GAS					
T ^a of hot water	50 °C - 60 °C					
T ^a of cold water	15 °C - 50 °C					

1- Non-binding information Consumption might vary depending on the characteristics of the facility
 2- Standard voltage: 400 V 3+N - For other voltages and options, please consult Fagor Industrial
 3- The adjustable feet allow for height adjustment, raising the machine by up to 60 mm









Pre-rinsing tables



MFDB-1200 LM-D, model, with sink and shower tap

General characteristics

- Manufactured for the compact and modular conveyor dishwashers.

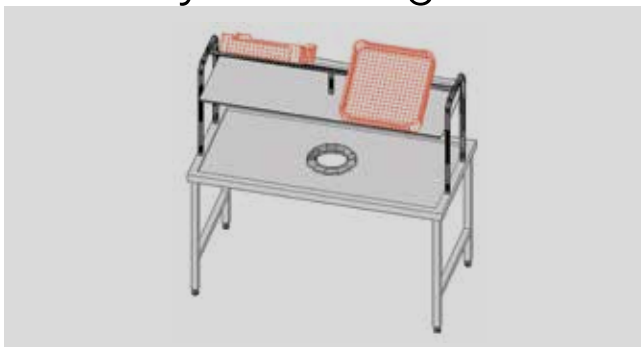

MODEL	CODE	SITUATION OF THE TABLE	EQUIPMENT FEATURES	DIMENSIONS (mm)	€
 MLB-1200 LM-D	19006097	R	- Rear guard - Lower rack - Guides for baskets	1.200x800x900	-
 MLB-1200 LM-I	19006096	L			
 MLB-1200 ECO/LM-D	19006099	R	- Rear guard - Lower rack - Guides for baskets	1.200x800x900	-
 MLB-1200 ECO/LM-I	19006098	L	- Hole for chimney		
 MFDB-1200 LM-D	19006104	R	- Rear guard - Sink - Shower tap - Lower rack - Guides for baskets	1.200x800x900	-
 MFDB-1200 LM-I	19006105	L			
 MFDB-1500 LM-D	19006404	R	- Rear guard - Sink - Shower tap - Lower rack - Guides for baskets	1.500x800x900	-
 MFDB-1500 LM-I	19006405	L			

Delivery / sorting tables



General characteristics

- Serving staff can deposit dirty dishes while the dishwashing staff are sorting them on the other side.
- The table is supplied with a sorting shelf (450 mm over the work top) and a waste disposal.
- Adjustable feet.

MODEL	CODE	SHELF DIMENSIONS (mm)	SHELF CAPACITY (BASKETS)	DIMENSIONS (mm)	€
 MD3C	19006410	1.530x600	3	1.600x800x1.450	-
 MD4C	19006509	2.030x600	4	2.100x800x1.450	-

Delivery / sorting tables



MFDH-1800 LM-I, model, with sink, shower tap, waste disposal, rear guard and guides for baskets

General characteristics

- Manufactured for the compact and modular conveyor dishwashers:

- Rear guard in all the models.
- Waste disposal.

- Space for the trash bin.
- Tables with sink built-in shower tap.

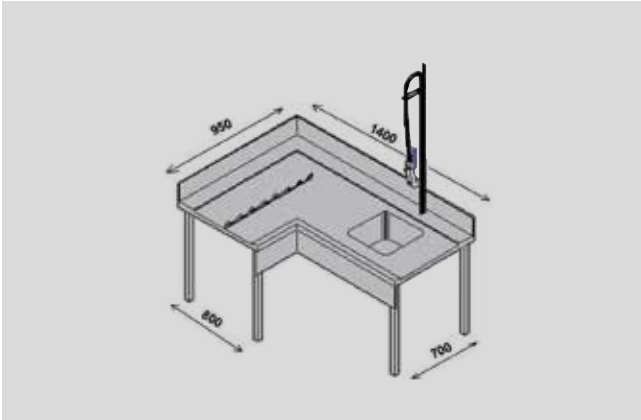

	MODEL	CODE	SITUATION OF THE TABLE	HOUSING FOR BIN	CHARACTERISTICS	DIMENSIONS (mm)	€
	MLH-1200 LM-D	19006100	R	OPEN	- Lower rack	1.200x800x900	-
	MLH-1200 LM-I	19006101	L				
	MLP-1200 LM-D	19006102	R	DOOR	- Lower rack	1.200x800x900	-
	MLP-1200 LM-I	19006103	L				
	MFDH-1200 LM-D	19006106	R	OPEN	- Sink - Shower tap - Lower rack	1.200x800x900	-
	MFDH-1200 LM-I	19006107	L				
	MFDP-1200 LM-D	19006108	R	DOOR	- Sink - Shower tap - Lower rack	1.200x800x900	-
	MFDP-1200 LM-I	19006109	L				
	MFDH-1500 LM-D	19006408	R	OPEN	- Sink - Shower tap - Lower rack	1.500x800x900	-
	MFDH-1500 LM-I	19006407	L				
	MFDP-1500 LM-D	19006409	R	DOOR	- Sink - Shower tap - Lower rack	1.500x800x900	-
	MFDP-1500 LM-I	19006406	L				
	MFDH-1800 LM-D	19006506	R	OPEN	- Sink - Shower tap - Lower rack - Guides for baskets	1.800x800x900	-
	MFDH-1800 LM-I	19006507	L				
	MFDP-1800 LM-D	19006508	R	DOOR	- Sink - Shower tap - Lower rack - Guides for baskets	1.800x800x900	-
	MFDP-1800 LM-I	19006505	L				

Pre-rinsing table with introducer of baskets in corner



General characteristics

- Rear guard 200 mm. Built in sink and shower tap.
- Length of the sink side: 1,400 mm - Depth: 700 mm.
- Element to introduce the baskets with the movement of the advancement system of the conveyor.
- Length of the introducer side: 950 mm - Depth: 800 mm.



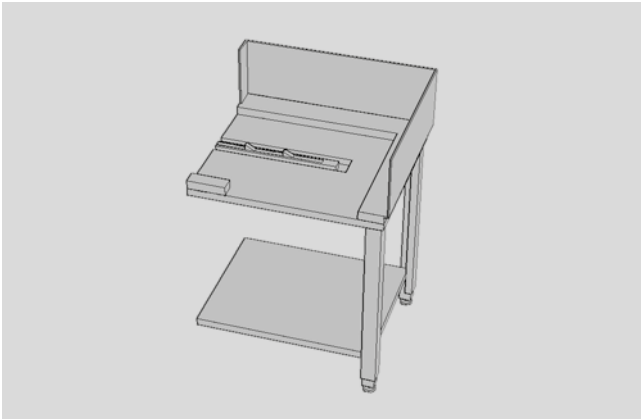

MODEL	CODE	SITUATION OF THE TABLE	EQUIPMENT FEATURES	DIMENSIONS (mm)	€
 MCFD-1000 D	19006350	R	- Rear guard - Sink - Shower tap - Introducer	1.400x950x900	-
 MCFD-1000 I	19006351	L			

Introducers of baskets in corner



General characteristics

- Element to introduce the baskets in the machine.
- Movement by the advancement system of the conveyor.
- Lower shelf.

MODEL	CODE	DESCRIPTION	DIMENSIONS (mm)	€
 E-90-I	19004789	INTRODUCER OF BASKETS BY THE LEFT SIDE For conveyors WITH neutral element at the entry.	800x700x850 (+250)	-
 E-90-I-CV	19004792	INTRODUCER OF BASKETS BY THE LEFT SIDE For conveyors WITHOUT neutral element at the entry. For conveyors WITH STEAM CONDENSER at the entry.	800x700x850 (+250)	-
 E-90-D	19004790	INTRODUCER OF BASKETS BY THE RIGHT SIDE For conveyors WITH neutral element at the entry.	800x700x850 (+250)	-
 E-90-D-CV	19004791	INTRODUCER OF BASKETS BY THE RIGHT SIDE For conveyors WITHOUT neutral element at the entry. For conveyors WITH STEAM CONDENSER at the entry.	800x700x850 (+250)	-

Automatized curves



General characteristics

- Automatic movement with the conveyor exit system.

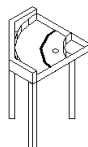
MODEL	CODE	INSTALLATION EXIT	DESCRIPTION	DIMENSIONS (mm)	€
180-I-TS	19004788	L	AUTOMATIZED CURVE 180° AT LEFT For models without neutral supplement on the exit. For models WITH DRYING TUNNEL, also.	778x1.442x900	-
	180-I	L	AUTOMATIZED CURVE 180° AT LEFT For models with neutral supplement on the exit.	778x1.442x900	-
	180-D-TS	R	AUTOMATIZED CURVE 180° AT RIGHT For models without neutral supplement on the exit. For models WITH DRYING TUNNEL, also.	778x1.442x900	-
180-D	19004787	R	AUTOMATIZED CURVE 180° AT RIGHT For models with neutral supplement on the exit.	778x1.442x900	-
	90-I-TS	L	AUTOMATIZED CURVE 90° AT LEFT For models without neutral supplement on the exit. For models WITH DRYING TUNNEL, also.	778x778x900	-
	90-I	L	AUTOMATIZED CURVE 90° AT LEFT For models with neutral supplement on the exit.	778x778x900	-
	90-D-TS	R	AUTOMATIZED CURVE 90° AT RIGHT For models without neutral supplement on the exit. For models WITH DRYING TUNNEL, also.	778x778x900	-
	90-D	R	AUTOMATIZED CURVE 90° AT RIGHT For models with neutral supplement on the exit.	778x778x900	-

Rolling tables



General characteristics

- Removable rolling units made in ABS, Ø 40 mm.
- Easy cleaning.
- Drain outlet.
- Adjustable stainless steel legs.
- Can be connected to the automatic curves.

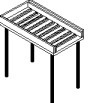
MODEL	CODE	DESCRIPTION	CAPACITY (BASKETS)	DIMENSIONS (mm)	€
	MR2C	Rolling table	2	1.150x630x870	-
	MR3C	Rolling table	3	1.660x630x870	-
	MR4C	Rolling table	4	2.170x630x870	-



A high performance solution.



Find out more!



Access the website



Comercial video



Sales brochure

Flight type dishwashers

Flight type dishwashers	241
Available belts	246
Accessories	253

Water connection:
It is advisable to introduce sanitary water in the dishwashers, with a temperature of 50 - 60 °C.

Water pressure:
Minimum: 2 bar = 2 kg/cm²
Maximum: 4 bar = 4 kg/cm²

Water softener:
All glass / dishwashers should be connected to a treated water supply when the local supply is over 10 HF / 6 HD.

Any issues derived from a bad installation that don't meet with the indicated conditions will not be considered as a warranty.

Electric flight dishwashers



BELTS AVAILABLE:

The machine must be ordered with one of these three types of belts:





- For plates and dish baskets
- For kitchenware (pots, containers and trays)
- For isothermal trays

The order must also include the dishwasher machine code and the belt code (on the following pages).

The machine price does not include the belt









General characteristics

- Manufactured in stainless steel. Double wall.
- Machines made of different modules according to models and needs.
- Entry tunnel 630 x 440 mm.
- Splash-guard modules at entry DE SERIES.
- Loading section (1.2 m) and unloading section (2.2 m), 900 mm high, with standard 600 mm-wide belt for dishes and trays.
- High-power, standard drier with possibility of adding up to 2 EXTRA standard driers.
- Adaptive final-rinse system with rinse pump with break tank that ensures low, consistent use, adapts to all speeds.
- Break tank for water inlet in the boiler at a constant pressure. Inlet solenoid valve with filter for break tank.
- Double-effect rinse module with pre-rinse tank and water boiler.
- Automatic detection of dishes using photocell sensor.
- Steam extraction system to prevent steam from leaving. Adjustable.
- Automatic water-renewal system for prewash. ONLY IN MODULES ABOVE FCO-W4.
- Double curtains at the entry and exit, and Foodservice | Dishwashing to divide the different inner areas.
- Stop/start switches at the entry and exit.
- Prewashing and washing arms made of stainless steel which can be detached for cleaning.
- Triple filtration in the washing modules.
- Embedded tank bottom to guarantee complete emptying and enable cleaning.
- Standard energy recovery system. Reduction of 9kWh.
- Double-effect rinse module with pre-rinse tank and boiler to heat water.
- Electronic temperature control of water for wash, prewash and rinse.
- Safety thermostat.
- 3 production programmes. It fulfils DIN 10534 standard (progr. 1)
- ANTI-BLOCK system with belt reversal.
- Detection of belt end with stop and auto-start.
- Doors with sensors to stop machine.
- Micro magnets for door opening and safety.
- 0.25 kW moto-reducer controlled by frequency converter.
- Stop/start switches at the entry and exit.
- Standard provision of baskets: 2 x CT-10, 2 x CV -16/105 and 1 basket for cutlery.

MODEL	HZ.	CODE	MAX. PRODUCTION (DISHES/HOUR)	ENTRY	MODULE COMPOSITION (°)	WATER (L/H)	ELECTRIC POWER (KW)	DIMMENSIONS (mm)	€
FCO-W4-RD R	50	19073687	3100	R	 W+4+RD	190-230	53,8	4988x900x2070	-
FCO-W4-RD L	50	19075203	3100	L	 W+4+RD	190-230	53,8	4988x900x2070	-
FCO-PW4-RD R	50	19068360	4600	R	 P+W+4+RD	190-230	53,4	5890x900x2070	-
FCO-PW4-RD L	50	19068366	4600	L	 P+W+4+RD	190-230	53,4	5890x900x2070	-

Circulation of baskets:
L: Entry through the left part of the machine.
R: Entry through the right part of the machine.

Standard voltage: 400V 3N~

- | | | | |
|---|------------------------------------|--|--|
|  E | Loading area |  4 | Rinse: gradual rinse module with rinse pump |
|  A | Splash guard |  4G | Rinse: gradual rinse module with rinse pump and incorporated gas generator |
|  P | Prewash: cold-water prewash module |  D | Drying: high-power drier module |
|  W | Wash: main wash module at 65°C |  R | Energy recovery system |

Electric flight dishwashers

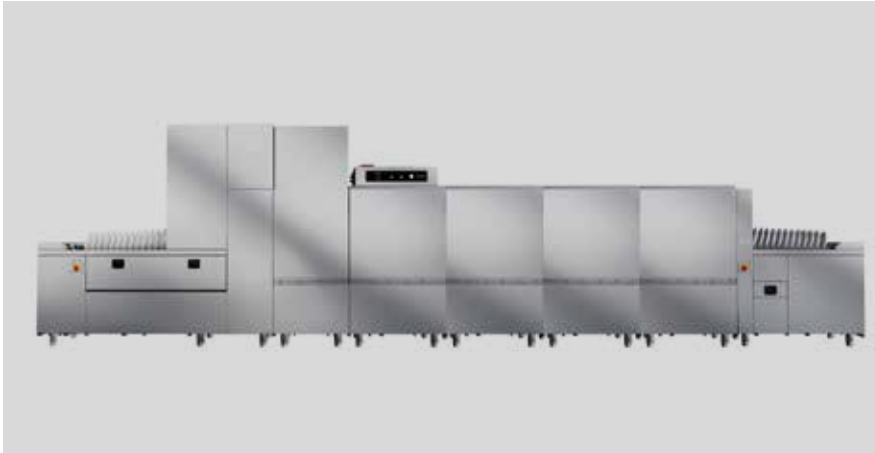

BELTS AVAILABLE:

The machine must be ordered with one of these three types of belts:

- For plates and dish baskets
- For kitchenware (pots, containers and trays)
- For isothermal trays

The order must also include the dishwasher machine code and the belt code (on the following pages).

The machine price does not include the belt

General characteristics

- Manufactured in stainless steel. Double wall.
- Machines made of different modules according to models and needs.
- Entry tunnel 630 x 440 mm.
- Splash-guard modules at entry DE SERIES.
- Loading section (1.2 m) and unloading section (2.2 m), 900 mm high, with standard 600 mm-wide belt for dishes and trays.
- High-power, standard drier with possibility of adding up to 2 EXTRA standard driers.
- Adaptive final-rinse system with rinse pump with break tank that ensures low, consistent use, adapts to all speeds.
- Break tank for water inlet in the boiler at a constant pressure. Inlet solenoid valve with filter for break tank.
- Double-effect rinse module with pre-rinse tank and water boiler.
- Automatic detection of dishes using photocell sensor.
- Steam extraction system to prevent steam from leaving. Adjustable.
- Automatic water-renewal system for prewash.
- Double curtains at the entry and exit, and Foodservice | Dishwashing to divide the different inner areas.
- Stop/start switches at the entry and exit.
- Prewashing and washing arms made of stainless steel which can be detached for cleaning.
- Triple filtration in the washing modules.
- Embedded tank bottom to guarantee complete emptying and enable cleaning.
- Standard energy recovery system. Reduction of 9kWh.
- Automatic pre-heating system.
- Triple-effect prewash system. Quadruple-effect prewash in FCO-P2W4 and FCO-P3W4 models.
- Double-effect rinse module with pre-rinse tank and boiler to heat water.
- Electronic temperature control of water for wash, prewash and rinse.
- Safety thermostat.
- 3 production programmes. It fulfils DIN 10534 standard (progr. 1)
- ANTI-BLOCK system with belt reversal.
- Detection of belt end with stop and auto-start.
- Doors with sensors to stop machine.
- Micro magnets for door opening and safety.
- 0.25 kW moto-reducer controlled by frequency converter.
- Stop/start switches at the entry and exit.
- Standard provision of baskets: 2 x CT-10, 2 x CV -16/105 and 1 basket for cutlery.

MODEL	HZ.	CODE	MAX. PRODUCTION (DISHES/HOUR)	ENTRY	MODULE COMPOSITION (*)	WATER (L/H)	ELECTRIC POWER (KW)	DIMMENSIONS (mm)	€
FCO-P2W4RDR	50	19074752	6600	R	P+2W+4+RD	220-270	68	6792x900x2070	-
FCO-P2W4RDL	50	19073649	6600	L	P+2W+4+RD	220-270	68	6792x900x2070	-
FCO-P3W4RDR	50	19075204	8600	R	P+3W+4+RD	220-270	82,6	7692x900x2070	-
FCO-P3W4RDL	50	19075119	8600	L	P+3W+4+RD	220-270	82,6	7692x900x2070	-

Circulation of baskets:
L: Entry through the left part of the machine.
R: Entry through the right part of the machine.

Standard voltage: 400V 3N~

- E Loading area
- A Splash guard
- P Prewash: cold-water prewash module
- W Wash: main wash module at 65°C
- 4 Rinse: gradual rinse module with rinse pump
- 4G Rinse: gradual rinse module with rinse pump and incorporated gas generator
- D Drying: high-power drier module
- R Energy recovery system

Available belts

Standard belt for dishes and baskets



CODE	DESCRIPTION	FOR MODELS		€
19072468	PLATE BELT FCO-W4-RD	FCO-W4-RD	FCO-W4G-RD	-
19074856	PLATE BELT FCO-PW4	FCO-PW4-RD	FCO-PW4G-RD	-
19073644	PLATE BELT FCO-P2W4	FCO-P2W4-RD	FCO-P2W4G-RD	-
19075208	PLATE BELT FCO-P3W4	FCO-P3W4-RD	FCO-P3W4G-RD	-

Specific belt for pots and containers



CODE	DESCRIPTION	FOR MODELS		€
19072498	KITCHENWARE BELT FCO-W4-RD	FCO-W4-RD	FCO-W4G-RD	-
19072700	KITCHENWARE BELT FCO-PW4-RD	FCO-PW4-RD	FCO-PW4G-RD	-
19072701	KITCHENWARE BELT FCO-P2W4-RD	FCO-P2W4-RD	FCO-P2W4G-RD	-
19072707	KITCHENWARE BELT FCO-P3W4-RD	FCO-P3W4-RD	FCO-P3W4G-RD	-

Specific belt for isothermal trays



CODE	DESCRIPTION	FOR MODELS		€
19072497	BELT FOR ISOTHERMAL TRAYS FCO-W4-RD	FCO-W4-RD	FCO-W4G-RD	-
19075209	BELT FOR ISOTHERMAL TRAYS FCO-PW4	FCO-PW4-RD	FCO-PW4G-RD	-
19075210	BELT FOR ISOTHERMAL TRAYS FCO-P2W4	FCO-P2W4-RD	FCO-P2W4G-RD	-
19075211	BELT FOR ISOTHERMAL TRAYS FCO-P3W4	FCO-P3W4-RD	FCO-P3W4G-RD	-

Modular elements and accessories for flight dishwashers



Modules for flight-type dishwashers (*)

MODELO	CÓDIGO	DESCRIPCIÓN	POWER (KW)	DIMMENSIONS (mm)	€
FDM-700	19075207	EXTRA DRIER	9.5 kw	700x900x2070	-
PRESSURE PUMP KIT	19004543	50 Hz - 230V 1N~	1 kw	-	-
PRESSURE PUMP KIT	19005676	60 Hz - 230V 1N~	1kw	-	-

Delivery of the machine in multiple packages

MODELO	CÓDIGO	DESCRIPCIÓN	€
BELT MODULES DISASSEMBLY KIT	19075212	Extra for the disassembly and delivery of the machine in several parts.	-

Modular sections for flight dishwashers (*)



MODULE	NAME	PUMPS (KW)	TANKS		BOILER (KW)	LARGE (mm)	POWER (KW)
			(L)	(KW)			
E	Loading area	-	-	-	-	1180	-
A	Splash guard	-	-	-	-	0	-
P	Prewash	1x2,6	100	-	-	900	2.6
W	Main wash	1x2,6	100	15 / 18 en el FCO-W4	-	900	14.6
2W	2 main washes	2x2,6	200	27	-	1800	32.2
3W	3 main washes	3x2,6	300	39	-	2700	46.8
4	Double rinse	0.26 + .15	30	5	18	700	18.41
4G	Double	0.26 + .15	30	5	-	700	0.41
S	Tunnel	-	-	-	-	0	9.5
R	Recovery system	-	-	-	-	0	0.90
S	Unloading area	-	-	-	-	2200	-

Table of modules that may form part of the flight-type dishwasher. The composition of the different modules is indicated on the previous pages.

(*) Notes on the additional modular elements:

All flight-type dishwashers are equipped, as standard, with a neutral, 150 mm anti-splash module at the entrance. This module is mounted on top of the loading table.

The drier tunnel is positioned at the exit of the machine. Its length is not increased since the tunnel is placed on top of the unloading table.

The energy recovery system is positioned on top of the dishwasher, and therefore the total length is not increased. Using the energy from the waste water this passes through an exchanger transferring heat to the cold water raising the temperature before entering the boiler.





The best accessory
for our wide range of
dishwashers.



Find out more!



Access the website

Dishwasher accessories

Water treatment	267
Baskets	269

Water connection:
It is advisable to introduce sanitary water in the dishwashers, with a temperature of 50 - 60 °C.

Water pressure:
Minimum: 2 bar = 2 kg/cm²
Maximum: 4 bar = 4 kg/cm²

Water softener:
All glass / dishwashers should be connected to a treated water supply when the local supply is over 10 HF / 6 HD.

Any issues derived from a bad installation that don't meet with the indicated conditions will not be considered as a warranty.

Water treatment

What you can achieve with treatment of water

Most of the water that comes out of the tap seems perfectly pure, however it may contain, as already mentioned, invisible contaminants. Removing these elements has a decisive influence on water quality.

Calcium and magnesium (hardness) are eliminated and the useful life of the equipment is significantly extended, reducing maintenance interventions and the use of detergents and rinse aids. Aspects that are anything but marginal in the Ho.Re.Ca.

	SOFTNER	REVERSE OSMOSIS
EXCELLENT WASH		X
SAVING DETERGENTS	X	X
REDUCES GLASS AND CERAMICS WEAR		X
PROTECTS THE MACHINE	X	X
GOODBYE MANUAL DRYING		X

Water treatment methods

Water treatment occurs mainly in two ways.

SOFTNER

The result obtained by using the water softener is to eliminate the calcium Ca^{2+} and magnesium Mg^{2+} ions, responsible for the hardness of the water. This effectively prevents the formation of encrustations which over time reduce the performance of the machines and cause malfunctions.

REVERSE OSMOSIS

Thanks to the very high degree of filtration that characterizes reverse osmosis machines, it is possible to obtain water with high quality characteristics. Water, passing through one or more membranes, is deprived not only of the elements that determine its hardness, but also of all substances contaminants, responsible, for example, for unwanted odors and flavors.

For excellent results and long maintenance intervals, the two technologies can be combined.



Manual water softeners

For hardness bigger than 5 HF / 3 HD.

Manual maintenance required.

CODE	DESCRIPTION	CAPACITY OF REGENERATION (*)	DIMENSIONS (mm)	€	
	19004620	DESCALING KIT 8 L.	700 litres between 2 regenerations	Ø 185x440 mm	-
	19004690	DESCALING KIT 12 L.	1.050 litres between 2 regenerations	Ø 185x560 mm	-
	19004798	DESCALING KIT 16 L.	1.400 litres between 2 regenerations	Ø 185x740 mm	-

Reverse osmosis

GREAT ADVANTAGES OF REVERSE OSMOSIS:

- It reduces detergent use by up to 60% and rinse aid by 70-100%.
- It polishes plates, glasses and cutlery, obtaining a mark-free washing result since it does not require drying after the wash.
- It extends the life of glassware and dishes since it reduces corrosion.
- It protects the machinery, extending its life.

General characteristics



Inlet water conditions:

- Type of inlet water: drinking water.
- Inlet water temperature: 5 °C - 35 °C.
- Minimum flow: 400 l/h.
- Supply pressure: 1.5-6 bar.
- Maximum conductivity of inlet water: 1200 µS / cm.
- Maximum inlet water hardness: up to 35°f with pH below 8.5 and up to 27°f with pH above 8.5.
- As of 10°dH 15°dH or 27°f, we recommend installing a water softening system prior to osmosis to prevent blockage of the membrane.
- High-flow reverse osmosis system.
- Vertical or horizontal installation.
- Flow: 120 l/h at 15°C.
- Recovery rate from 25% to 60%.
- Typical rejection rate: 95 %.
- Electrical connection 230V ~ 50/60Hz.
- Prefilter that reduces and eliminates water turbidity, chlorine, tastes and smells. Its nominal filtration rate is 5 microns.
- Easy to install.
- Prefilter change alarm.
- Water leak alarm.
- Low-pressure alarm at system entrance.
- Manual bypass valve.

ONLY VALID FOR: AD-505, AD-125, COP-404, COP-504 y COP-144









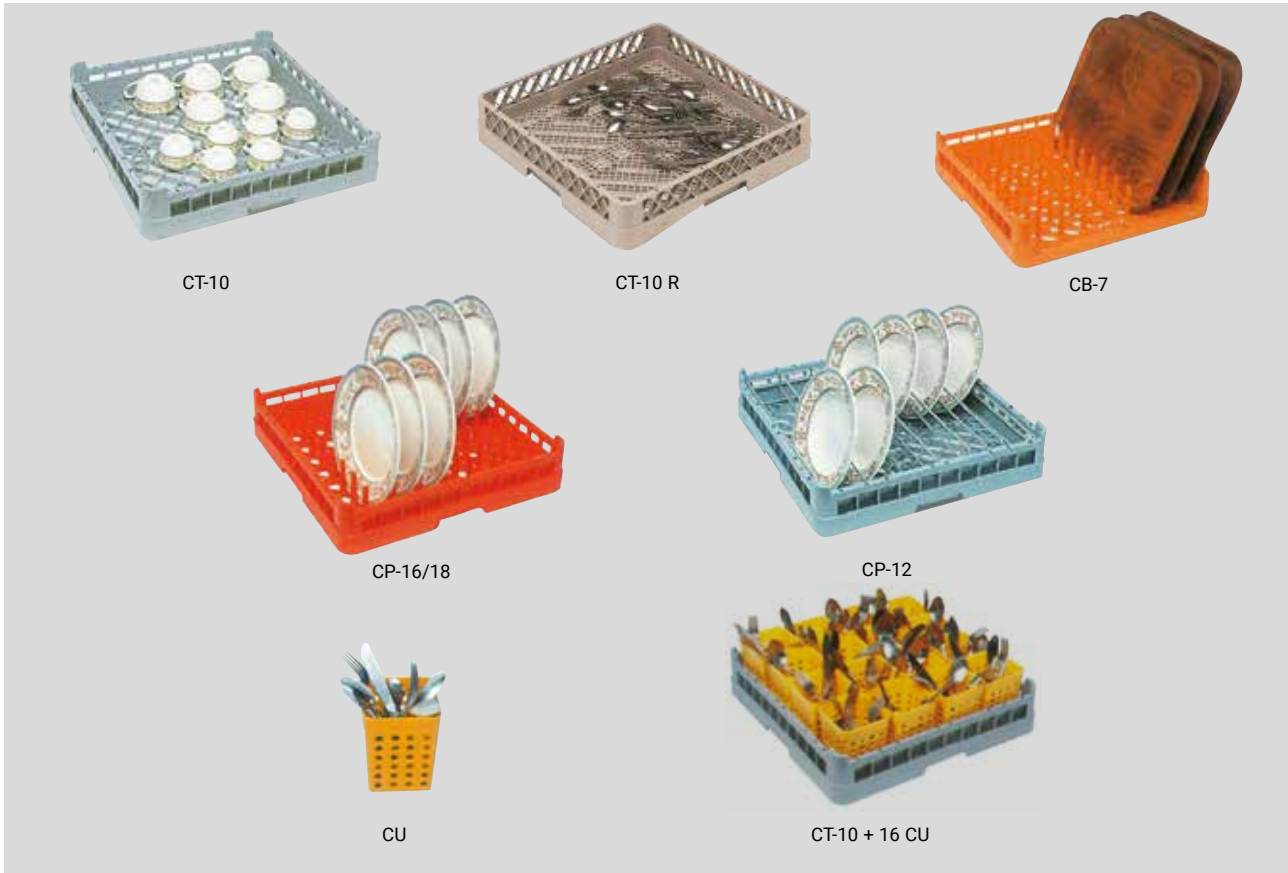

MODEL	CODE	FLOW 15°C (L/H)	NUMBER OF MEMBRANES	VOLTAGE (V)	FREQUENCY (HZ)	POWER (KW)	DIMENSIONS (mm)	€
REVO-120	19076763	120	2	230	50 / 60	0,33	145 x 560 x 455	-

MODEL	CODE	DESCRIPTION	€
PREF-PACK6	19076764	Pack of 6 units of rapid-connection cartridges with extruded carbon block filter	-

Baskets for dishes, trays and cutlery

Made of polypropylene.



	MODEL	CODE	TYPE OF BASKET	Ø MAX (mm)	CAPACITY PRODUCT	COLOUR	DIMENSIONS (mm)	€
		CT-10	19000484	Standard basket	Dishes	Grey	500x500x110	-
		SMALL BASKET 400	19082432	Standard basket	Dishes	Grey	400x400x110	-
		DISHES ACCESSORY 400	19084452				400x400x110	-
		SMALL BASKET 350	19082434	Standard basket	Dishes	Grey	350x350x110	-
		DISHES ACCESSORY 350	19084453				350x350x110	-
		CT-10 R	19087265	Standard basket with dense base	Dishes and cutlery	Brown	500x500x110	-
		CB-7	19000483	Trays for self-service	7	Orange	500x500x110	-
		CP-16/18	19000487	Dishes	Ø 230 16 ÷ 18 (*) Ø 320 8 ÷ 9 (*)	Orange	500x500x110	-
		CP-12	19004479	Deep dishes	Ø 230 12 (*) Ø 320 6 (*)	Grey	500x500x140	-
		CU	19000792	Cutlery	15 (**)	Yellow	105x105x130	-

Notes: (*) It depends of the position of the dishes in the basket.
(**) To guarantee a correct washing of the cutlery, it is not recommended to introduce more units.

Baskets for glasses

Made of polypropylene.



Baskets for 16 glasses and cups ø 110 mm

MODEL	CODE	TYPE OF BASKET	Ø MAX (mm)	H MAX (mm)	CAPACITY PRODUCT	COLOUR	DIMENSIONS (mm)	€
CV-16/105	19000488	Low glasses	110	100	16	Blue	500x500x140	-
CV-16/155	19000489	Medium glasses	110	150	16	Blue	500x500x190	-
CV-16/205	19000490	High glasses	110	200	16	Blue	500x500x240	-



Baskets for 25 glasses and cups ø 85 mm

MODEL	CODE	TYPE OF BASKET	Ø MAX (mm)	H MAX (mm)	CAPACITY PRODUCT	COLOUR	DIMENSIONS (mm)	€
CV-25/105	19000491	Low glasses	85	100	25	Blue	500x500x140	-
CV-25/155	19000492	Medium glasses	85	150	25	Blue	500x500x190	-
CV-25/205	19000493	High glasses	85	200	25	Blue	500x500x240	-

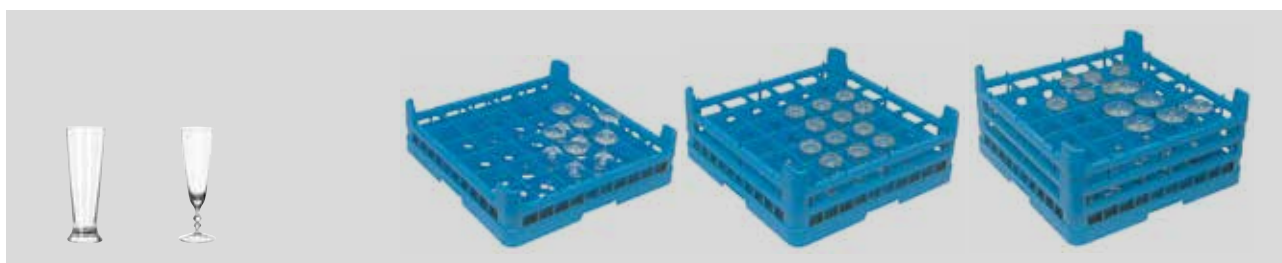

Baskets for 36 glasses and cups ø 70 mm

MODEL	CODE	TYPE OF BASKET	Ø MAX (mm)	H MAX (mm)	CAPACITY PRODUCT	COLOUR	DIMENSIONS (mm)	€
CV-36/105	19000494	Low glasses	70	100	36	Blue	500x500x140	-
CV-36/155	19000495	Medium glasses	70	150	36	Blue	500x500x190	-
CV-36/205	19000496	High glasses	70	200	36	Blue	500x500x240	-