

Trademarks

OTOFIX is a trademark of Autel Intelligent Technology Corp., Ltd., registered in China, the United States, and other countries. All other marks are trademarks or registered trademarks of their respective holders.

Copyright Information

No part of this manual may be reproduced, stored in a retrieval system or transmitted in any form or by any means electronic, mechanical, photocopying, recording, or otherwise without the prior written permission of Autel Intelligent Technology Corp., Ltd.

Disclaimer of Warranties and Limitation of Liabilities

All information, specifications and illustrations in this manual are based on the latest information available at the time of printing.

Autel Intelligent Technology Corp., Ltd. reserves the right to make changes at any time without notice. While information of this manual has been carefully checked for accuracy, no guarantee is given for the completeness and correctness of the contents, including but not limited to the product specifications, functions, and illustrations.

Autel Intelligent Technology Corp., Ltd. will not be liable for any direct, special, incidental, or indirect damages, or for any economic consequential damages (including lost profits) as a result of using the product.

IMPORTANT

Before operating or maintaining this unit, please read this manual carefully, paying extra attention to the safety warnings and precautions.

For Services and Support

 www.otofixtech.com

 1-855-288-3587/1-855-AUTELUS (North America)

0086-755-86147779 (China)

 support@otofixtech.com

For technical assistance in all other markets, please contact your local OTOFIX distributor.

Safety Information

For your own safety and the safety of others, and to prevent damage to the device and vehicles upon which it is used, it is important that the safety instructions presented throughout this manual be read and understood by all persons operating or coming into contact with the device.

There are numerous procedures, techniques, tools, and parts required for servicing vehicles, as well as the skills of the person doing the work. Because of the vast number of test applications and variations in the products that can be tested with this equipment, we cannot possibly anticipate or provide advice or safety messages to cover every circumstance. It is the automotive technician's responsibility to be knowledgeable of the system being tested. It is crucial to use proper service methods and test procedures. It is essential to perform tests in an appropriate and acceptable manner that does not endanger your safety, the safety of others in the work area, the device being used, or the vehicle being tested.

Before using the device, always refer to and follow the safety messages and applicable test procedures provided by the manufacturer of the vehicle or equipment being tested. Use the device only as described in this manual. Be sure to read, understand, and follow all safety messages and instructions in this manual.

Safety Messages

Safety messages are provided to help prevent personal injury and equipment damage. All safety messages are introduced by a signal word indicating the hazard level.

DANGER

Indicates an imminently hazardous situation which, if not avoided, will result in death or serious injury to the operator or to bystanders.

WARNING

Indicates a potentially hazardous situation which, if not avoided, could result in death or serious injury to the operator or to bystanders.

Safety Instructions

The safety messages herein cover situations Autel is aware of at the time of publication. Autel cannot know, evaluate or advise you as to all of the possible hazards. You must be certain that any condition or service procedure encountered does not jeopardize your personal safety.

 **DANGER**

When an engine is operating, keep the service area WELL VENTILATED or attach a building exhaust removal system to the engine exhaust system. Engines produce carbon monoxide, an odorless, poisonous gas that causes slower reaction time and can lead to serious personal injury or loss of life.

 **Do Not Turn the Volume Up Too Loud When Using Headphones**

Listening at high volumes that over-stimulate the ear for long periods of time may result in loss of hearing.

 **SAFETY WARNINGS**

- Always perform automotive testing in a safe environment.
- Wear safety eye protection that meets ANSI standards.
- Keep clothing, hair, hands, tools, test equipment, etc. away from all moving or hot engine parts.
- Operate the vehicle in a well-ventilated work area, as exhaust gases are poisonous.
- Put the transmission in PARK (for automatic transmission) or NEUTRAL (for manual transmission) and make sure the parking brake is engaged.
- Put blocks in front of the drive wheels and never leave the vehicle unattended while testing.
- Be extra cautious when working around the ignition coil, distributor cap, ignition wires, and spark plugs. These components create hazardous voltages when the engine is running.
- Keep a fire extinguisher suitable for gasoline, chemical, and electrical fires nearby.
- Do not connect or disconnect any test equipment while the ignition is on or the engine is running.
- Keep the test equipment dry, clean, free from oil, water or grease. Use a mild detergent on a clean cloth to clean the outside of the equipment as necessary.
- Do not drive the vehicle and operate the test equipment at the same time. Any distraction may cause an accident.
- Refer to the service manual for the vehicle being serviced and adhere to all diagnostics procedures and precautions. Failure to do so may result in personal injury or damage to the test equipment.
- To avoid damaging the test equipment or generating false data, make sure the vehicle battery is fully charged and the connection to the vehicle DLC is clean and secure.
- Do not place the test equipment on the distributor of the vehicle. Strong electro-magnetic interference can damage the equipment.

Contents

1 USING THIS MANUAL	1
1.1 CONVENTIONS.....	1
1.1.1 <i>Bold Text</i>	1
1.1.2 <i>Notes and Important Messages</i>	1
1.1.3 <i>Hyperlinks</i>	1
1.1.4 <i>Illustrations</i>	1
1.1.5 <i>Procedures</i>	2
2 GENERAL INTRODUCTION	3
2.1 D1 PLUS/MAX TABLET	3
2.1.1 <i>Function Descriptions</i>	3
2.1.2 <i>Power Sources</i>	5
2.1.3 <i>Technical Specifications</i>	5
2.2 V1 — VEHICLE COMMUNICATION INTERFACE.....	7
2.2.1 <i>Function Descriptions</i>	7
2.2.2 <i>Power Sources</i>	8
2.2.3 <i>Technical Specifications</i>	9
2.3 ACCESSORIES.....	9
3 GETTING STARTED	10
3.1 POWERING UP.....	10
3.1.1 <i>Application Buttons</i>	11
3.1.2 <i>Locator and Navigation Buttons</i>	12
3.1.3 <i>System Status Icons</i>	14
3.2 POWERING DOWN.....	14
3.3 REBOOTING SYSTEM.....	15
4 DIAGNOSTICS.....	16
4.1 ESTABLISHING VEHICLE COMMUNICATION.....	16
4.1.1 <i>Vehicle Connection</i>	16
4.1.2 <i>VCI Connection</i>	16
4.1.3 <i>No Communication Message</i>	18
4.2 GETTING STARTED.....	19
4.2.1 <i>Vehicle Menu Layout</i>	19
4.3 VEHICLE IDENTIFICATION.....	21
4.3.1 <i>Auto VIN Scan</i>	21
4.3.2 <i>Manual VIN Input</i>	22

4.3.3	<i>Scan VIN/License</i>	23
4.3.4	<i>Manual Vehicle Selection</i>	23
4.3.5	<i>Alternative Vehicle Identification</i>	24
4.4	NAVIGATION.....	24
4.4.1	<i>Diagnostics Screen Layout</i>	24
4.4.2	<i>Screen Messages</i>	27
4.4.3	<i>Making Selections</i>	27
4.5	MAIN MENU.....	27
4.5.1	<i>Auto Scan</i>	28
4.5.2	<i>Control Unit</i>	31
4.5.3	<i>ECU Information</i>	32
4.5.4	<i>Trouble Codes</i>	32
4.5.5	<i>Live Data</i>	34
4.5.6	<i>Active Test</i>	39
4.5.7	<i>Special Functions</i>	40
4.6	SERVICE	41
4.6.1	<i>Function Descriptions</i>	42
4.7	GENERIC OBDII OPERATIONS	42
4.7.1	<i>General Procedures</i>	43
4.7.2	<i>Function Descriptions</i>	44
4.8	EXITING DIAGNOSTICS	46
5	SERVICE	47
5.1	OIL RESET	48
5.2	ELECTRIC PARKING BRAKE (EPB).....	48
5.2.1	<i>EPB Safety</i>	48
5.3	TIRE PRESSURE MONITORING SYSTEM (TPMS)	49
5.4	BATTERY MANAGEMENT SYSTEM (BMS)	49
5.5	IMMOBILIZER (IMMO) KEYS.....	49
5.6	STEERING ANGLE SENSOR (SAS)	50
6	BATTERY TEST	51
6.1	OTOFIX BT1 LITE TESTER	51
6.1.1	<i>Function Descriptions</i>	51
6.1.2	<i>Power Sources</i>	52
6.1.3	<i>Technical Specifications</i>	53
6.2	TEST PREPARATION.....	53
6.2.1	<i>Inspecting the Battery</i>	53

6.2.2	<i>Establishing Communication</i>	53
6.2.3	<i>Connecting to a Battery</i>	54
6.3	IN-VEHICLE TEST	55
6.3.1	<i>Battery Test</i>	55
6.3.2	<i>Starter Test</i>	58
6.3.3	<i>Generator Test</i>	60
6.4	OUT-VEHICLE TEST.....	61
6.4.1	<i>Battery Test</i>	61
7	SETTINGS	63
7.1	UNIT	63
7.2	LANGUAGE.....	64
7.3	PRINTING SETTINGS	64
7.3.1	<i>Printer Settings</i>	64
7.3.2	<i>Printing Operations</i>	64
7.4	SCAN REPORT.....	65
7.5	AUTO UPDATE	65
7.6	VEHICLE LIST	66
7.7	SYSTEM SETTINGS	66
7.8	ABOUT US	66
8	SOFTWARE UPDATES	67
9	DATA MANAGER.....	70
9.1	VEHICLE HISTORY.....	71
9.1.1	<i>Historical Test Record</i>	72
9.2	WORKSHOP INFORMATION	73
9.3	CUSTOMER.....	74
9.4	IMAGE	75
9.5	REPORT	76
9.6	PDF.....	76
9.7	REVIEW DATA	76
9.8	UNINSTALL APPS.....	76
9.9	DATA LOGGING.....	76
10	VCI MANAGER.....	77
11	REMOTE DESKTOP	79
11.1	OPERATIONS	79
12	USER FEEDBACK.....	81
13	QUICK LINK.....	82

14 SUPPORT	83
14.1 MY ACCOUNT	83
14.1.1 <i>Personal Info</i>	83
14.1.2 <i>Update Info</i>	83
14.1.3 <i>Service Info</i>	83
14.2 TRAINING	83
14.3 DATA LOGGING	84
14.4 FAQ	84
15 OEM AUTHORIZATION	85
16 MAXVIEWER	87
17 MAINTENANCE AND SERVICE	89
17.1 MAINTENANCE INSTRUCTIONS	89
17.2 TROUBLESHOOTING CHECKLIST	90
17.3 ABOUT BATTERY USAGE	91
17.4 SERVICE PROCEDURES	92
17.4.1 <i>Technical Support</i>	92
17.4.2 <i>Repair Service</i>	93
17.4.3 <i>Other Services</i>	93
18 COMPLIANCE INFORMATION	94
18.1 FCC COMPLIANCE	94
18.2 RF WARNING STATEMENT	94
18.3 ROHS COMPLIANCE	95
18.4 CE COMPLIANCE	95
18.5 IC COMPLIANCE	95
19 WARRANTY	96

1 Using This Manual

This manual contains device usage instructions.

Some illustrations shown in this manual may make reference to modules and optional equipment that are not included in your system.

1.1 Conventions

The following conventions are used:

1.1.1 Bold Text

Bold text is used to highlight selectable items such as buttons and menu options.

Example:

- Tap **OK**.

1.1.2 Notes and Important Messages

Notes

A **NOTE** provides helpful information such as additional explanations, tips, and comments.

Important

IMPORTANT indicates a situation that if not avoided may result in damage to the tablet or vehicle.

1.1.3 Hyperlinks

Hyperlinks are available in electronic documents. Blue italic text indicates a selectable hyperlink and blue underlined text indicates a website link or an email address link.

1.1.4 Illustrations

Illustrations used in this manual are samples and the actual testing screen may vary for each vehicle being tested. Observe the menu titles and on-screen instructions to make correct option selection.

1.1.5 Procedures

An arrow icon indicates a procedure.

Example:

➤ **To use the camera**

1. Tap the **Camera** button. The camera screen opens.
2. Focus the image to be captured in the viewfinder.
3. Tap the camera icon on the right side of the screen. The viewfinder now shows the captured picture and auto-saves the taken photo.
4. Tap the thumbnail image on the top-right corner of the screen to view the stored image.
5. Tap the **Back** or **Home** button to exit the camera application.

2 General Introduction

The OTOFIX D1 Plus and OTOFIX D1 Max (hereinafter referred as D1 Plus/Max) are two comprehensive automobile diagnostics devices. Utilizing the powerful Qualcomm SM6225 octa-core processor, and 10.4 inch touch screens, combined with the best possible coverage of OE-level diagnostics, and based on the revolutionary multitask-capable Android Operating system, the OTOFIX D1 Plus and OTOFIX D1 Max organize information with test instrumentation to help you diagnose symptoms easily, quickly and efficiently and are ideal products to repair shops achieve easy diagnosis.

There are two main components to the OTOFIX diagnostics system:

- D1 Plus/Max tablet — the central processor and monitor for the system
- V1 — Vehicle Communication Interface (VCI)

This manual describes the construction and operation of these devices and how they work together to deliver diagnostics solutions.

2.1 D1 Plus/Max Tablet

2.1.1 Function Descriptions

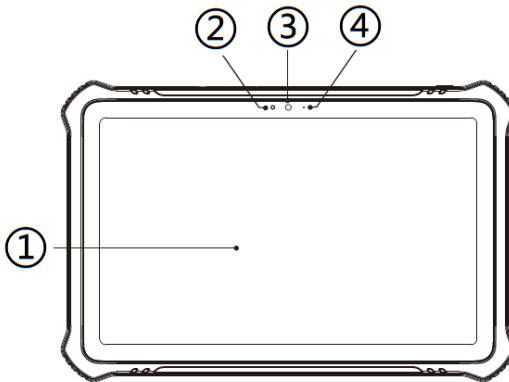

Figure 2-1 D1 Plus/Max Tablet, Front View

- ① 10.4-inch Touchscreen
- ② Ambient Light Sensor — detects ambient light brightness.
- ③ Front Camera
- ④ Power LED

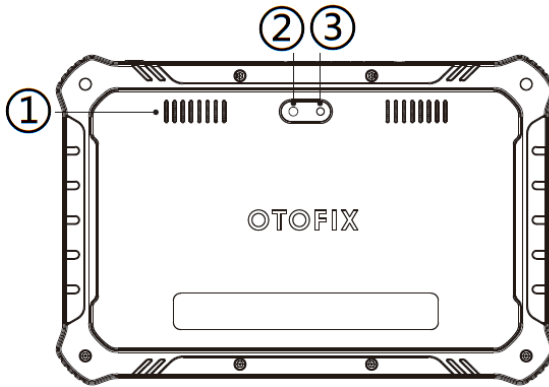

Figure 2-2 D1 Plus/Max Tablet, Back View

- ① Speaker
- ② Rear Camera
- ③ Camera Flash

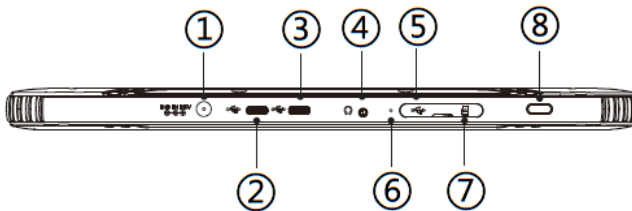

Figure 2-3 D1 Plus/Max Tablet, Top View

- ① DC Power Supply Input Port
- ② USB Port
- ③ USB Port
- ④ Headphone Jack
- ⑤ Mini USB Port
- ⑥ Microphone
- ⑦ SD Card Slot
- ⑧ **Power/Lock** Button — press and hold to turn the tablet on/off, or tap to lock the screen

Table 2-1 D1 Plus/Max Power LED Description

LED	Color	Description
Power LED	Green	Lights green when the tablet is powered on and the battery level is over 20%.
	Yellow	Lights yellow when the tablet is powered on and the battery level is between 10 to 20%.
	Red	Lights red when the tablet is powered on and the battery level is lower than 10%.

2.1.2 Power Sources

The tablet can receive power from any of the following sources:

- Internal battery pack
- AC/DC power supply

Internal Battery Pack

The tablet can be powered with the internal rechargeable battery.

AC/DC Power Supply

The tablet can be powered from a wall socket using the AC/DC power adapter. The AC/DC power supply also charges the internal battery pack.

2.1.3 Technical Specifications

Table 2-2 D1 Plus/Max Technical Specifications

Item	Description
Operating System	Android 11
Processor	Qualcomm SM6225 octa-core processor
Memory	4 GB RAM & 128 GB
Display	10.4-inch touchscreen with 2000 x 1200 p resolution
Connectivity	<ul style="list-style-type: none">● Wi-Fi (802.11 b/g/n/ac)● Type-C USB● Bluetooth V5.0

Item	Description
Camera	<ul style="list-style-type: none"> • Rear: 8 megapixel, autofocus with flashlight • Front: 5 megapixel
Sensors	<ul style="list-style-type: none"> • Gravity Accelerometer • Ambient Light Sensor (ALS)
Audio Input/Output	<ul style="list-style-type: none"> • Input: Microphone • Output: Bipolar speakers, 3-Band 3.5 mm stereo/standard headset jack
Power and Battery	<ul style="list-style-type: none"> • 7,250 mAh 3.7 V lithium-polymer battery • Charging via 12 V AC/DC power supply
Input Voltage	9 to 12.4 V
Operating Temperature	0 to 50 °C (32 to 122 °F)
Storage Temperature	-10 to 60 °C (14 to 140 °F)
Dimensions (W x H x D)	273.1 mm (10.8") x 180.9 mm (7.1") x 17.8 mm (0.7")
Net Weight	775 g (11.3 lb.)
Supported Automotive Protocols	ISO 9142-2, ISO 14230-2, ISO 15765-4, K/L-Line, Flashing Code, SAE-J1850 VPW, SAE-J1850 PWM, CAN ISO 11898, Highspeed, Middlespeed, Lowspeed and Singlewire CAN, GM UART, UART Echo Byte Protocol, Honda Diag-H Protocol, TP 2.0, TP 1.6, SAE J1939, SAE J1708, Fault-Tolerant CAN

2.2 V1 — Vehicle Communication Interface

The OTOFIX V1 is a small vehicle communication interface (VCI) used to connect to a vehicle's data link connector (DLC) and connect with the tablet via Bluetooth or USB cable for vehicle data transmission.

2.2.1 Function Descriptions

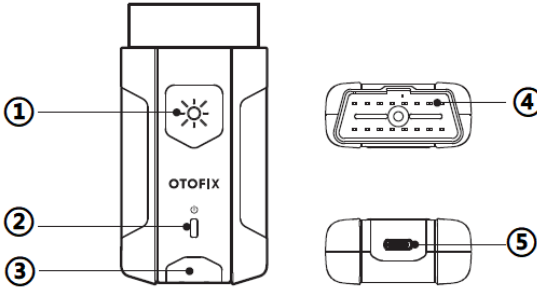

Figure 2-4 OTOFIX V1 Views

- ① Flashlight Button
- ② Power LED
- ③ Vehicle/Connection LED
- ④ Vehicle Data Connector (16-pin)
- ⑤ USB Port

Table 2-3 OTOFIX V1 LED Description

LED	Color	Description
Power LED	Yellow	Lights solid yellow when the VCI is powered on and performing self-check.
	Green	Lights solid green when the VCI is ready for use.
	Red	Flashes red when the firmware is upgrading.
Vehicle/Connection LED	Green	<ul style="list-style-type: none">● Lights solid green when VCI is connected via USB cable.● Flashes green when VCI is communicating via USB cable.
	Blue	<ul style="list-style-type: none">● Lights solid blue when VCI is connected via Bluetooth.● Flashes blue when VCI is communicating via Bluetooth.

2.2.2 Power Sources

The VCI device can receive power from the following sources:

- Vehicle Power
- AC/DC Power Supply

Vehicle Power

The VCI device operates on 12/24 Volt vehicle power, which receives power via the vehicle data connection port. The device powers on whenever it is connected to an OBDII/EOBD compliant data link connector (DLC).

AC/DC Power Supply

The VCI device can be powered from a wall socket using the AC/DC power adapter.



2.2.3 Technical Specifications

Table 2-4 OTOFIX V1 Technical Specifications

Item	Description
Communications	<ul style="list-style-type: none"> ● Bluetooth V4.2 + BR/EDR/LE ● USB 2.0
Wireless Frequency	2.4 GHz
Input Voltage Range	6 to 36 V DC
Supply Current	150 mA @ 12 V DC
Operating Temp.	0 to 50 °C (32 to 122 °F)
Storage Temp.	-10 to 60 °C (14 to 140 °F)
Dimensions (L x W x H)	89.89 mm (3.53") x 46.78 mm (1.84") x 21 mm (0.82")
Weight	70.7 g (0.156 lb.)

2.3 Accessories

Table 2-5 Accessories

	<p>Type-C USB Cable</p> <p>Connects the tablet and V1.</p>
	<p>AC/DC External Power Adapter</p> <p>Supplies power to the tablet.</p>

3 Getting Started

Make sure the tablet has sufficient power or is connected to an external power supply (see [Power Sources](#) on page 5.)

NOTE

The images and illustrations depicted in this manual may differ slightly from those in the most recent products.

3.1 Powering Up

Long press the **Power/Lock** button on the top-right side of the tablet to power on the unit. The system boots up and displays the OTOFIX Job Menu.

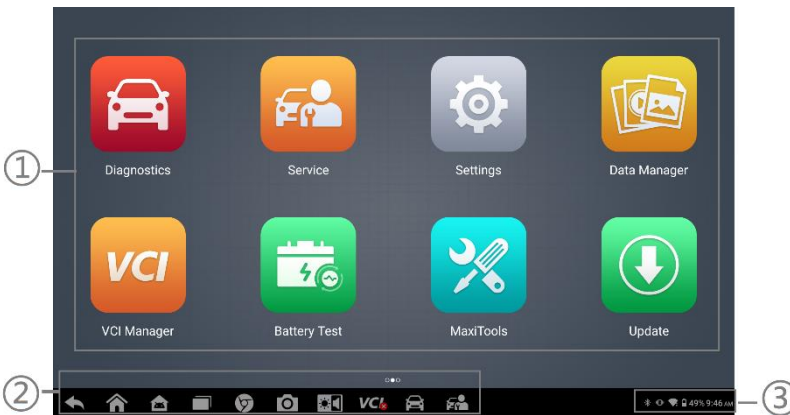

Figure 3-1 Sample OTOFIX Job Menu

- ① Application Buttons
- ② Locator and Navigation Buttons
- ③ System Status Icons

NOTE











We recommend you lock the screen when not in use to protect private information in the system and conserve power.



Almost all operations on the tablet are controlled through the touchscreen. The touchscreen navigation is menu-driven, allowing for quick access to test procedures and data through a series of questions and options. Detailed descriptions of the menu items are found in the chapters for each application.

3.1.1 Application Buttons

Table 3-1 Application Buttons describes each of the applications in the OTOFIX system.

Table 3-1 Application Buttons







Icon	Name	Description
	Diagnostics	Configures the unit to operate as a diagnostics tool. See Diagnostics on page 16 for details.
	Service	Accesses special functions menu. See Service on page 47 for details.
	Battery Test	Assesses the Battery Test menu. See Battery Test on 51 for details.
	Settings	Allows you to set the OTOFIX system settings and view general information about the tablet. See Settings on page 63 for details.
	Update	Checks for the latest update available for the OTOFIX system, and installs new software. See Software Update on page 67 for details.
	Data Manager	Accesses the organization system for saved data files. See Data Manager on page 70 for details.
	VCI Manager	Establishes and manages the Bluetooth connection to the VCI device. See VCI Manager on page 77 for details.
	Remote Desktop	Configures your unit to receive remote support using the TeamViewer application program. See Remote Desktop on page 79 for details.
	User Feedback	Allows you to submit questions related to this product. See User Feedback on page 81 for details.
	Quick Link	Provides associate website bookmarks to allow quick access to product updates, service, support, and other information. See Quick Link on page 82 for details.





Icon	Name	Description
	Support	Launches the Support platform which synchronizes Autel's on-line service base station with the OTOFIX tablet. See Support on page 83 for details.
	OEM Authorization	Unlocks the gateway ECU (CGW) for some vehicles to perform advanced diagnostics tests. See OEM Authorization on page 85 for details.
	MaxiViewer	Provides a quick search for supported functions and/or vehicles. See MaxiViewer on page 87 for details.

3.1.2 Locator and Navigation Buttons

Operations of locator and navigation buttons at the bottom of the screen are described in the table below.

Table 3-2 Locator and Navigation Buttons

Button	Name	Description
	Locator	Indicates the location of the screen in relation to others when multiple screens are open. Swipe the screen left or right to view the previous or next screen.
	Back	Returns to the previous screen.
	Home	Returns to the OTOFIX Job Menu.
	Android Home	Returns to the Android system Home screen.
	Recent Apps	Displays a list of applications that are currently working. To open an application, tap on it. To remove an application, swipe up.
	Chrome	Launches the built-in web browser.
	Camera	Opens the camera with short press; takes and saves a screenshot image with long press. The image files are saved in the Data Manager application for later review. See Data Manager on page 70.

Button	Name	Description
	Display & Sound	Allows you to adjust the brightness of the screen and the volume of the audio output.
	VCI	Opens the VCI Manager application. The green badge at the bottom-right corner indicates the tablet is communicating with the VCI device. A red "cross" icon indicates no connection.
	Diagnostics Shortcut	Returns to the Diagnostics operation interface from other applications.
	Service Shortcut	Returns to the Service operation interface from other applications.

➤ **To use the camera**

1. Tap the **Camera** button. The camera screen opens.
2. Focus the image to be captured in the viewfinder.
3. Tap the camera icon on the right side of the screen. The viewfinder now shows the captured picture and auto-saves the taken photo.
4. Tap the thumbnail image on the top-right corner of the screen to view the stored image.
5. Tap the **Back** or **Home** button to exit the camera application.









3.1.3 System Status Icons

By tapping on the bottom-right corner, a Shortcuts Panel will be displayed, on which you are allowed to set various system settings. The operations of each button on the panel are described in [Table 3-3 Shortcuts Panel Buttons](#).

NOTE

The Shortcuts buttons will be highlighted when enabled and dimmed when disabled.

Table 3-3 Shortcuts Panel Buttons

Button	Name	Description
	Wi-Fi	Enables/disables Wi-Fi.
	Bluetooth	Enables/disables Bluetooth.
	Battery	Displays battery status. Tap to enable/disable battery saving mode.
	Do Not Disturb	Enables/disables Do-not-disturb mode.
	Flashlight	Turns the flashlight on/off.
	Auto Rotate	Enables/disables screen auto-rotate.
	Airplane Mode	Enables/disables Airplane Mode.
	Logger	Accesses the Log Collection screen.

3.2 Powering Down

All vehicle communications must be terminated before shutting down the tablet. A warning message appears if you attempt to shut down the tablet while the VCI unit is communicating with the vehicle. Forcing a shut-down while communicating may lead to ECM problems on some vehicles. Exit the Diagnostics application before powering down.

➤ To power down the tablet

1. Press and hold the **Power/Lock** button.
2. Tap Power Off.
3. Tap **OK**. The tablet will turn off after several seconds.

3.3 Rebooting System

In case of a system crash, press and hold the **Power/Lock** button to power off the tablet and restart it.

➤ **To reboot the tablet**

1. Press and hold the **Power/Lock** button.
2. Tap Restart.
3. Tap **OK**. The tablet will turn off and restart.

4 Diagnostics

By establishing a data link to the electronic control systems of the vehicle being serviced through the V1, the Diagnostics application allows you to retrieve diagnostics information, view live data parameters, and perform active tests. The Diagnostics application can access the electronic control module (ECM) for various vehicle control systems, such as engine, transmission, antilock brake system (ABS), airbag system (SRS) and more.

4.1 Establishing Vehicle Communication

The Diagnostics operations require connecting the OTOFIX Diagnostics Platform to the vehicle through the V1 and test adapters (for non-OBDII vehicles). To establish proper vehicle communication to the tablet, you need to perform the following steps:

1. Connect the V1 to the vehicle's DLC for both communication and power source.
2. Connect the V1 to the tablet via Bluetooth pairing or USB connection.
3. When these are done, check the VCI navigation button at the bottom bar on the screen. If the button displays a green badge, the OTOFIX diagnostics platform is ready to start vehicle diagnosis.

4.1.1 Vehicle Connection

The tablet communicates with the vehicle via the Bluetooth connection provided by the OTOFIX V1:

To connect the V1 to the vehicle, simply insert the Vehicle Data Connector on the V1 into the vehicle's DLC (usually located under the vehicle dashboard) and the V1 automatically powers on.

NOTE

The vehicle's DLC is not always located under the dashboard. Refer to the user manual of the test vehicle for additional connection information.

4.1.2 VCI Connection

After the V1 is properly connected to the vehicle, and the Power LED on the VCI device illuminates solid green or blue, indicating that the V1 is ready to establish communication with the tablet. The V1 supports 2 communication methods with the tablet: Bluetooth and USB.

4.1.2.1 Pairing Up via Bluetooth

Bluetooth pairing is recommended as the first choice for the communication between the tablet and the VCI device. The working range for Bluetooth communication allows you to perform vehicle diagnosis freely around the workshop with greater convenience.

If you use more than one VCI device to connect to the vehicles, you can perform vehicle diagnosis on various vehicles conveniently by pairing the tablet separately to each of the VCI devices connected to the different vehicles via Bluetooth, without the need to repeat the plugging and unplugging procedure (which is unavoidable when using traditional wired connection) saving you time and increasing efficiency.

➤ **To pair up the tablet with the V1 via Bluetooth**

1. Power on the tablet.
2. Connect the OTOFIX Diagnostics Platform to the vehicle through the V1. See [Establishing Vehicle Communication](#) on page 16.
3. Tap **VCI Manager** on the OTOFIX Job Menu of the tablet.
4. Tap **VCI BT** (short for VCI Bluetooth) from the connection mode list.
5. Toggle Bluetooth **ON**. The device will start searching for available units for pairing.

NOTE

If no VCI device is found, this may indicate that the signal strength of the transmitter is too weak to be detected. In this case, try to get closer to the device, or reposition the VCI device, and remove all possible objects that cause signal interference. When these are done, tap the **Scan** button at the top-right corner to start searching again.

6. Depending on the VCI you use, the device name may appear as "Maxi" suffixed with the serial number. Select the appropriate device for pairing.
7. When pairing is successfully done, the connection status displayed to the right of the device name is shown as Connected.
8. Wait for a few seconds, and the VCI button on the system Navigation Bar at the bottom of the screen shall display a green badge, and the Connection LED on the V1 illuminates solid blue, indicating the tablet is connected to the VCI device, and is ready to perform vehicle diagnosis.

4.1.2.2 USB Cable Connection

The USB cable connection is a simple and quick way to establish communication between the tablet and the V1. After properly connecting the USB cable from the tablet to the VCI device, the VCI navigation button at the bottom bar of the screen shows a green badge in a few seconds, and the Connection LED on the V1 illuminates solid green, indicating the connection between the devices is successful. The OTOFIX diagnostics platform is now ready to perform vehicle diagnosis.

NOTE

When both the communication methods are applied at the same time, the OTOFIX system will use the USB communication as the default priority.

4.1.3 No Communication Message

- A. If the tablet is unable to connect to the VCI, an "Error" message displays. An "Error" message indicates the tablet is not communicating with the VCI device. Troubleshoot the error by performing the following steps:
- Ensure the VCI device is powered on.
 - When using the wireless connection, ensure the network is configured correctly and the proper device has been connected.
 - If the tablet loses communication abruptly during diagnostics, ensure no objects are causing signal interruption.
 - Ensure the VCI device is properly positioned with the VCI front side up.
 - Move the tablet closer to the VCI device. If using the wired connection, ensure the cable is securely attached to the VCI.
 - Ensure the VCI communication mode is lit for the selected communication type, Bluetooth, or USB.
- B. If the VCI device is unable to establish a communication link, a message will display troubleshooting instructions. Possible causes for the communication error include:
- The VCI device is unable to establish a communication link with the vehicle.
 - A vehicle system has been selected for diagnoses that is not supported by the vehicle.
 - There is a loose connection.
 - There is a blown vehicle fuse.
 - The vehicle or the data case has a wiring fault.
 - There is a circuit fault in the data cable or adapter.
 - The vehicle identification is incorrectly entered.

4.2 Getting Started

Prior to first use of the Diagnostics application, make sure the VCI device has been synchronized with the tablet to establish a communication link. See [VCI Manager](#) on page 77.

4.2.1 Vehicle Menu Layout

When the VCI device is properly connected to the vehicle, and paired to the tablet, the platform is ready to start the vehicle diagnosis. Tap the **Diagnostics** application on the OTOFIX Job Menu, the screen then opens the Vehicle Menu.





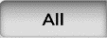



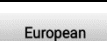



Figure 4-1 Sample Vehicle Menu Screen

- ① Top Toolbar Buttons
- ② Manufacturer Icons

4.2.1.1 Top toolbar Buttons

The operations of the Toolbar buttons at the top of the screen are listed and described in the table below.

Table 4-1 Top Toolbar Buttons

Button	Name	Description
	Home	Returns to the OTOFIX Job Menu.
	VID	Opens a dropdown list; tap Auto detect for auto VIN detection; tap Manual input to enter VIN manually; tap Scan VIN/License to scan the VIN code/license numbers using the built-in camera.
	All	Displays all the vehicle makes in the vehicle menu.
	Favorites	Displays user-favorited vehicle makes.
	History	Displays your saved vehicle history records. This option provides you direct access to the previously tested vehicle recorded during previous test sessions. See Vehicle History on page 71.
	USA	Displays the USA vehicle menu.
	European	Displays the European vehicle menu.
	Asia	Displays the Asian vehicle menu.
	China	Displays the Chinese vehicle menu.
	Search	Opens the virtual keyboard, allowing you to manually enter a specific vehicle make.
	Cancel	Exits the search screen or cancels an operation.

4.2.1.2 Manufacturer Buttons

The Manufacturer buttons display the various vehicle logos and brand names. Select the required manufacturer button after the VCI device is properly connected to the vehicle to start a diagnostics session.

4.3 Vehicle Identification

The OTOFIX diagnostics system supports five methods for Vehicle Identification:

- Auto VIN Scan
- Manual VIN Input
- Scan VIN/License
- Manual Vehicle Selection
- OBD Direct Entry

4.3.1 Auto VIN Scan

The OTOFIX diagnostics system features the latest VIN-based Auto VIN Scan function to identify vehicles in just one touch, which allows the technician to quickly detect vehicles, scan all the diagnosable ECUs on every vehicle and run diagnostics on the selected system.

➤ To perform Auto VIN Scan

1. Tap the **Diagnostics** application from the OTOFIX Job Menu. The Vehicle Menu displays.
2. Tap the **VID** button on the top toolbar.
3. Tap **Auto detect**. The tester starts VIN scanning on the vehicle's ECU. Confirm the vehicle information and the system will guide you to the Vehicle Diagnostics screen directly.

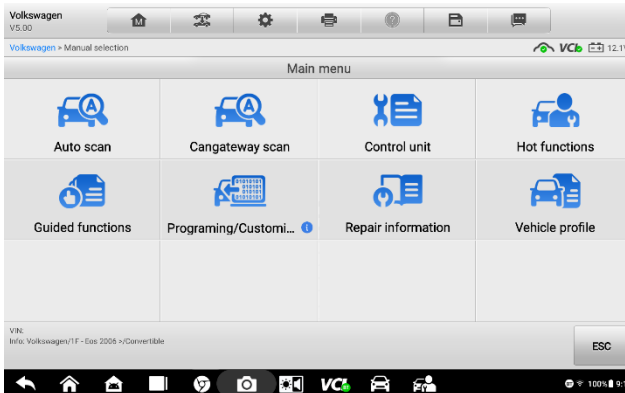

Figure 4-2 Sample Vehicle Diagnostics Screen

In some cases when users have selected the vehicle brand instead of performing Auto VIN Scan in the first place, the system still provides an option for vehicle VIN scan.

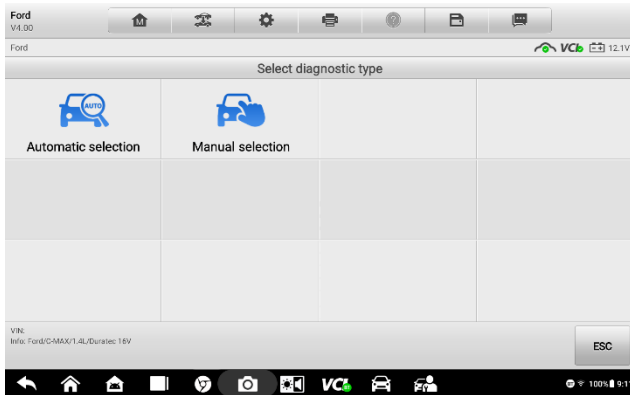

Figure 4-3 Sample Diagnostics Type Selection Screen

Select **Automatic selection** and the system will proceed to acquire VIN information automatically or allow users to enter the VIN manually.

4.3.2 Manual VIN Input

For some vehicles that do not support the Auto VIN Scan function, the OTOFIX diagnostics system allows you to enter the VIN manually.

➤ **To perform Manual VIN Input**

1. Tap the **Diagnostics** application from the OTOFIX Job Menu. The Vehicle Menu displays.
2. Tap the **VID** button on the top toolbar.
3. Tap Manual input.
4. Tap the input box and enter the correct VIN.

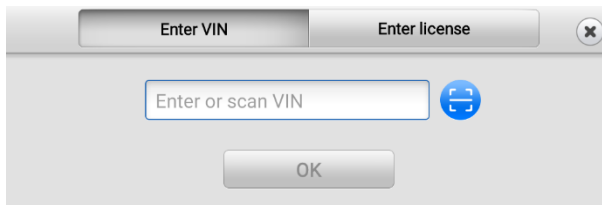

Figure 4-4 Manual VIN Input

5. Tap **OK**. The vehicle will be identified in a few seconds, and once the vehicle information is confirmed, the system will guide you to the Vehicle Diagnostics screen directly. (see [Figure 4-2 Sample Vehicle Diagnostics Screen](#))
6. Tap the **✕** icon to exit the Manual Input dialog box.

4.3.3 Scan VIN/License

Tap **Scan VIN/License** in the dropdown list, the camera will be opened. On the right side of the screen, from top to bottom, four options are available: Select Recognition Record, Scan Bar Code, Scan VIN, and Scan License.

NOTE

The Scan License method is supported in limited regions. Please manually enter the license number if it is not available.

After selecting one of four options and position the tablet to align the VIN or license number within the scanning window, the result displays in the Recognition result dialog box after scanned. Tap **OK** to confirm the result, and then the vehicle information confirmation screen will display on the tablet. If all the vehicle information is correct, tap the icon in the middle of the screen to confirm the VIN of the vehicle being tested, tap **OK** to continue.

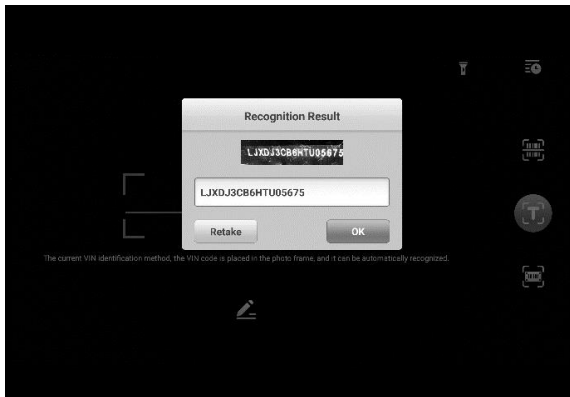

Figure 4-5 Sample Scan VIN Code 1

If the VIN/License number cannot be scanned, please manually enter the VIN/License number. Tap **OK** to continue. Manually enter the license number and select a vehicle brand in the vehicle information confirmation screen. Tap the icon in the middle of the screen to confirm the VIN of the vehicle being tested. Tap **OK** to continue.

4.3.4 Manual Vehicle Selection

When the VIN is not automatically retrievable through the vehicle's ECU, or when the VIN is unknown, you can manually select the vehicle.

4.3.4.1 Step-by-step Vehicle Selection

This mode of vehicle selection is menu driven; you can simply follow the on-screen prompts and make a series of choices. Each selection you make advances you to the next screen. An **Esc** button at the lower-right corner of the screen will bring you back to

the previous step. Exact procedures may vary somewhat according to the vehicle being serviced.

4.3.5 Alternative Vehicle Identification

Occasionally, you may identify a vehicle that the tester does not recognize; the database does not support, or which has some unique characteristics that prevent it from communicating with the tester through the normal channels. In these instances, you are provided with the OBD direct entry, through which you can perform generic OBDII or EOBD tests. For details, see *Generic OBDII Operations* on page 42.

4.4 Navigation

This section describes how to navigate the Diagnostics interface and select test options.

4.4.1 Diagnostics Screen Layout

The diagnostics screens typically include four sections.

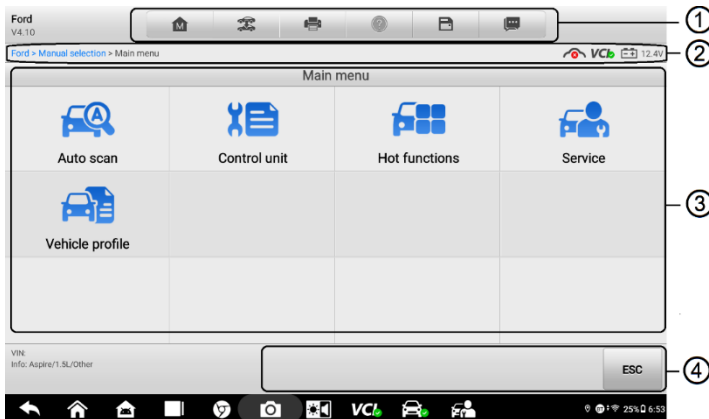







Figure 4-6 Sample Diagnostics Screen

- ① Diagnostics Toolbar
- ② Status Information Bar
- ③ Main Section
- ④ Function Buttons

4.4.1.1 Diagnostics Toolbar

The Diagnostics Toolbar contains several buttons that allow you to print and save the displayed data, along with other controls. The table below provides a brief description for the operations of these buttons.

Table 4-2 Diagnostics Toolbar Buttons

Button	Name	Description
	Home	Returns to the OTOFIX Job Menu.
	Vehicle Swap	Exits the diagnostics session of the currently identified vehicle, and returns to the vehicle menu screen to select another vehicle for testing.
	Print	Saves and prints a copy of the displayed data. See Printing Operations on page 64 for additional information.
	Help	Provides instructions or tips for operations of various diagnostics functions.
	Save	<p>Opens a submenu and provides 3 options to save data.</p> <ul style="list-style-type: none"> ● Tap Take a Screenshot to take a screenshot of the current screen. ● Tap Save All Data to save a PDF file (use this save option when data displays on multiple screens). ● Tap Save Report to connect the diagnostics information with the vehicle. <p>All saved data are stored in the Data Manager for later reviews. See Data Manager on page 70.</p>
	Data Logging	<p>Records the communication data and ECU information of the vehicle. The saved data can be reported and sent to technical support center via the Internet.</p> <p>You can go to the Support application to follow up on the progress. See Data Logging on page 84 for further information.</p>

➤ **To print data in Diagnostics**

1. Tap the **Diagnostics** application from the OTOFIX Job Menu. The **Print** button on the diagnostics toolbar is available throughout the whole Diagnostics operations.
2. Tap **Print** whenever you want to make a printing. A drop-down menu displays.
 - **Print this page** — prints a screenshot copy of the current screen.
 - **Print all data** — prints a PDF copy of all displayed data.
3. A temporary file will be created and sent to the PC for printing.
4. When the file is transferred successfully, a confirmation message will appear.

📎 **NOTE**

Make sure the tablet is connected to the PC network, either via Wi-Fi or LAN, before printing. For more instructions on printing, see [Printing Operations](#) on page 64.

➤ **To submit Data Logging reports in Diagnostics**

1. Tap the **Diagnostics** application from the OTOFIX Job Menu. The **Data Logging** button on the diagnostics toolbar is available throughout the whole Diagnostics operations.
2. Tap the **Data Logging** button to display the error options. Select a specific error and tap **OK**. A submission form will appear to let you fill in the report information.
3. Tap **Send** to submit the report form via the Internet. A confirmation message will appear when sending is successful.

4.4.1.2 *Status Information Bar*

The Status Information Bar at the top of the Main Section displays the following items:

- **Network Status Icon** — indicates whether a network is connected.
- **VCI Icon** — indicates the communication status between the tablet and the VCI device.
- **Battery Icon** — indicates the battery status of the vehicle.

4.4.1.3 *Main Section*

The Main Section of the screen varies depending on the stage of operations. The Main Section can show vehicle identification selections, the main menu, test data, messages, instructions and other diagnostics information.

4.4.1.4 *Function Buttons*

The displayed Function Buttons at this section of the screen varies depending on the stage of operations. They can be used to navigate, save or clear the diagnostics data, exit scanning as well as make other function controls. The functions of these buttons will be introduced respectively in the following sections of the corresponding test operations.

4.4.2 **Screen Messages**

Screen messages appear when additional input is needed before proceeding. There are mainly three types of on-screen messages as to their purposes: Confirmation, Warning, and Error.

4.4.2.1 *Confirmation Messages*

Confirmation messages inform you when you are about to perform an action that cannot be reversed or when an action has been initiated and your confirmation is needed to continue.

When a user-response is not required to continue, the message displays briefly before automatically disappearing.

4.4.2.2 *Warning Messages*

This type of messages informs you when completing the selected action may result in an irreversible change or loss of data. The typical example for this is the "Erase Codes" message.

4.4.2.3 *Error Messages*

Error messages inform you when a system or procedural error has occurred. Examples of possible errors include a disconnection or communication interruption.

4.4.3 **Making Selections**

The Diagnostics application is a menu-driven program that presents a series of choices. As you select from a menu, the next menu in the series. Each selection narrows the focus and leads to the desired test. Use your fingertip or the stylus pen to make menu selections.

4.5 **Main Menu**

The Diagnostics application allows you to establish a data link to the electronic control system of the vehicle via the VCI device for vehicle diagnosis and service. You can operate functional tests, retrieve vehicle diagnostics information such as trouble codes, event codes and live data for various vehicle control systems, such as engine, transmission, ABS and more.

After a section is selected and the tablet establishes communication with the vehicle via the VCI device, the corresponding function menu or selection menu displays.

➤ **To perform a diagnostics function**

1. Establish communication with the vehicle via the VCI device.
2. Identify the vehicle by selecting from the menu options.
3. Locate the required system for testing by **Auto scan** or through menu driven selections in **Control unit**.
4. Select the desired test from the Function menu.

NOTE

With the diagnostics toolbar on top of the screen throughout the whole diagnostics procedures, you are allowed to make various controls of the diagnostics information at any time, such as printing and saving the displayed data, getting help information, or performing data logging, etc.

4.5.1 Auto Scan

The Auto Scan function performs a comprehensive scanning over all the systems on the vehicle's ECU in order to locate fault systems and retrieve DTCs. The sample operation interface of Auto Scan displays as below.

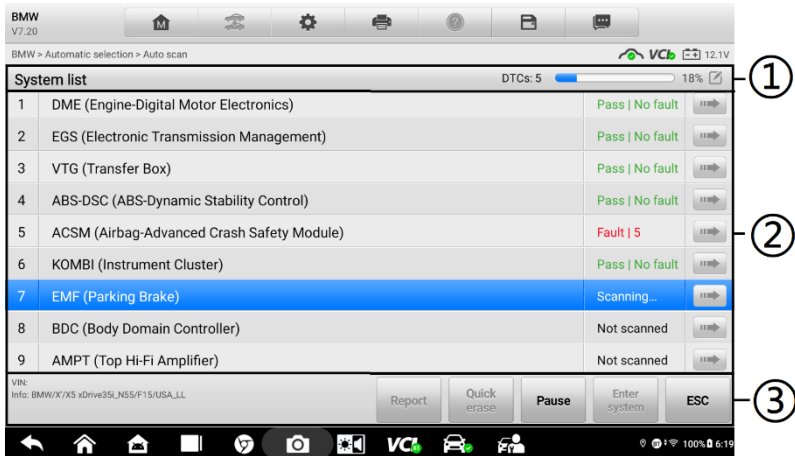



Figure 4-7 Sample Auto Scan Operation Screen

- ① Navigation Bar
- ② Main Section
- ③ Function Buttons

4.5.1.1 Navigation Bar

- List Tab — displays the scanned data in list format.
- Progress Bar — indicates the test progress.

4.5.1.2 Main Section

- Column 1 — displays the system numbers.
- Column 2 — displays the scanned systems.
- Column 3 — displays the diagnostics marks indicating different conditions of the test result:
 - **-!-**: indicates that the scanned system may not support the code reading function, or there is a communication error between the tester and the control system.
 - **-?-:** indicates that the vehicle control system has been detected, but the tester cannot accurately locate it.
 - **Fault | #:** indicates there is/are detected fault code(s) present; "#" indicates the number of the detected faults.
 - **Pass | No fault:** indicates the system has passed the scanning process and no fault has been detected.
 - **Not Scanned:** Indicates the system has not been scanned.
 - **No Response:** Indicates the system has not received a response.
- Column 4 — displays the  button. Tap it to the right of the system item, on which you want to perform further diagnosis and other test activities. A Function Menu screen shall then display.

4.5.1.3 Function Buttons

The table below provides a brief description of the Function Buttons' operations in Auto Scan.

Table 4-3 Function Buttons in Auto Scan

Name	Description
Report	Displays the diagnostics data in the report form.
Quick erase	Deletes codes. A warning message screen will display to inform you of possible data loss when this function is selected.
Fault scan	Starts scanning and changes to the Pause button.
Pause/Continue	Suspends or continues scanning.
Enter system	Enters the ECU system.
ESC	Returns to the previous screen or exit Auto Scan.

4.5.2 Control Unit

This option allows you to manually locate a required control system for testing through a series of choices. You simply follow the menu driven procedure, and make proper selection each time; the program will guide you to the diagnostics function menu after a few choices you have made.

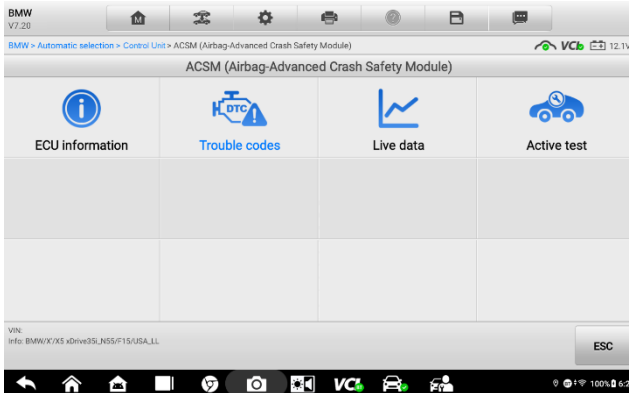

Figure 4-8 Sample Function Menu Screen

The Function Menu options vary slightly for different vehicles. The function menu may include:

- **ECU information** — displays detailed ECU information. Select to display information screen.
- **Trouble codes** — contains Read Codes and Erase Codes. The former displays detailed DTC information retrieved from the vehicle control module, the latter facilitates you to erase DTCs and other data from the ECU.
- **Live data** — retrieves and displays live data and parameters from the vehicle's ECU.
- **Active test** — provides specific subsystem and component tests. This selection may appear as **Actuators**, **Actuator Test**, or **Function Tests**, etc., and the tests options vary depending on the manufacturer and model.
- **Special functions** — provides component adaptation or variant coding functions for custom configurations, and also allows you to reprogram adaptive values for certain components after making repairs. Depending on the vehicle, this selection may sometimes appear as **Control unit adaptations**, **Special function**, **Variant coding**, **Configuration**, etc.

4.5.3 ECU Information

This function retrieves and displays the specific information for the tested control unit, including unit type, version numbers and other specifications.

4.5.4 Trouble Codes

4.5.4.1 Read Codes

This function retrieves and displays the DTCs from the vehicle's control system. The Read Codes screen varies for each vehicle being tested. On some vehicles, freeze frame data can also be retrieved for viewing. The sample Read Codes screen displays as below:

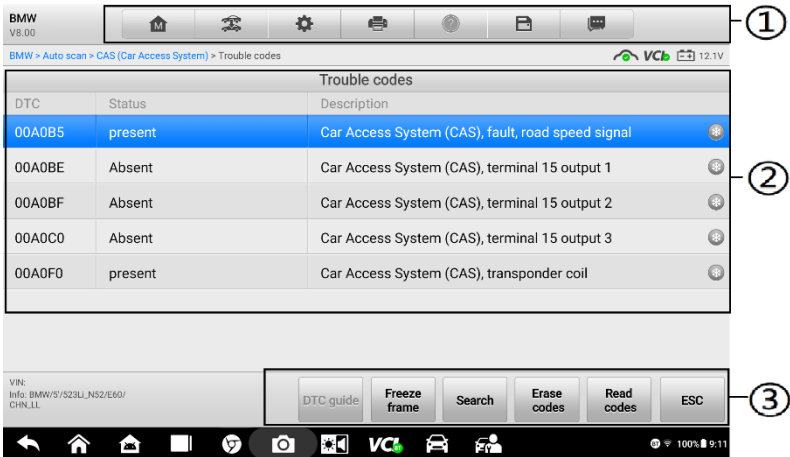

Figure 4-9 Sample Trouble Codes Screen

① Diagnostics Toolbar Buttons — see [Table 4-2 Diagnostics Toolbar Buttons](#) on page 25 for detailed descriptions of the operations for each button.

② Main Section

- DTC Column — displays the retrieved codes from the vehicle.
- Status Column — indicates the status of the retrieved codes.
- Description Column — displays detailed descriptions for the retrieved codes.
- Snowflake Icon — only displays when freeze frame data is available for viewing; Selecting this icon will display a data screen, which looks very similar to the Read Codes interface, therefore same operation method may be applied.

③ Function Buttons

Table 4-4 Function Buttons in Trouble Codes

Name	Description
DTC guide	Checks the related help information.
Freeze frame	Displays when freeze frame data is available for viewing; Tap the icon to display data screen. The Freeze Frame interface is similar to that of the Read Codes interface and share similar operations.
Search	Searches the selected DTC for additional information on the Internet.
Erase codes	Erases codes from the ECU. It is recommended that DTCs are read and needed repairs are performed before erasing codes.
Read codes	Retrieves and displays the DTCs from the vehicle control system. The Read Codes screen varies for each vehicle being tested.
ESC	Returns to the previous screen or exit Trouble Code.

4.5.4.2 Erase Codes

After reading the retrieved codes from the vehicle and certain repairs have been carried out, you can erase the codes from the vehicle using this function. Before performing this function, make sure the vehicle's ignition key is in the ON (RUN) position with the engine off.

➤ **To erase codes**

1. Tap **Erase codes** at the bottom of the screen.
2. A warning message displays to inform you of data loss when this function is applied.
 - Tap **Yes** to continue. A confirmation screen displays when the operation is successfully done.
 - Tap **No** to exit.
3. Tap **ESC** on the confirmation screen to exit Erase Codes.
4. Perform the Read Codes function again to check if the code erasing is successful.

4.5.5 Live Data

When this function is selected, the screen displays the data list for the selected module. The items available for any control module vary from one vehicle to another. The parameters display in the order that they are transmitted by the ECM, so expect variation among vehicles.

Gesture scrolling allows you to quickly move through the data list. Simply swipe the screen up or down to locate the data you want. The figure below shows a typical Live Data screen.



Figure 4-10 Sample Live Data Screen

- ① Diagnostics Toolbar Buttons — See [Table 4-2 Diagnostics Toolbar Buttons](#) on page 25 for detailed descriptions of the operations for each button.
- ② Current Directory Path
- ③ Status Information Bar — See [Status Information Bar](#) on page 26 for detailed descriptions of the operations for each icon.
- ④ Main Section
 - **Name** column — displays the parameter names.
 - Check box — tap the check box at the left side of the parameter name to make selection of an item. Taps the check box again to deselect the item.
 - Drop-down button — tap the drop-down button at the right side of the parameter name opens a submenu, which provides various choices for data display mode.
 - **Value** column — displays the values of the parameter items.
 - **Unit** column — displays the unit for the parameters.

Display Mode

There are 4 types of display modes available for data viewing, allowing you to view various types of parameters in the most suitable way.

Tap the drop-down button on the right side of the parameter name to open a submenu. A total of 7 buttons will be displayed: The 4 buttons to the left represent different data display modes, plus one **Information** button, active when additional information is available, and one **Unit Change** button, for switching the unit of displayed data, and one **Trigger** button, tap to open the "Trigger Setting" screen.

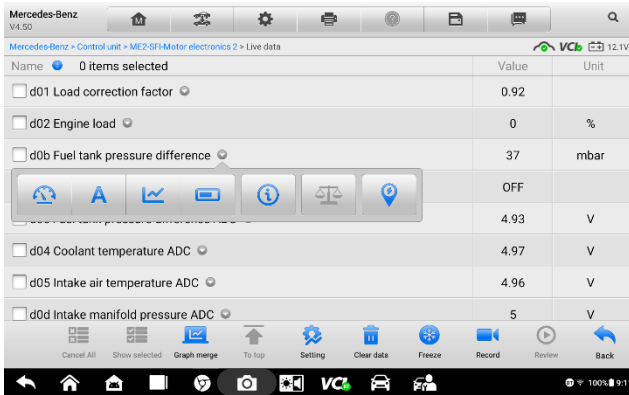

Figure 4-11 Sample Display Mode Screen

Each parameter item displays the selected mode independently.

- **Analog Gauge Mode** — displays the parameters in form of an analog meter graph
- **Text Mode** — this is the default mode which displays the parameters in texts and shows in list format

NOTE

Reading of status parameters, such as a switch reading, which are mostly in word form, like ON, OFF, ACTIVE, and ABORT, etc., can only be displayed in Text Mode. Whereas reading of value parameters, such as a sensor reading, can be displayed in text mode and other graph modes.

- **Waveform Graph Mode** — displays the parameters in waveform graphs

When this mode is applied, five control buttons will appear on the right side of the parameter item, allowing you to manipulate the display status.

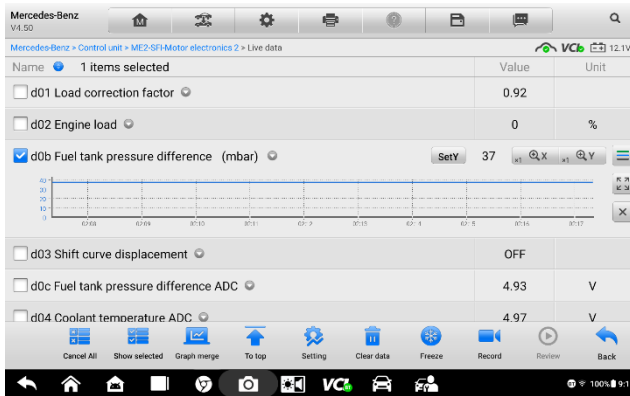

Figure 4-12 Sample Waveform Graph Mode

- ◆ **Settings (SetY)** — sets the minimum and maximum value of the Y axis.
- ◆ **Edit** — edits the waveform color and the line thickness.
- ◆ **Scale** — changes the scale values, which are displayed below the waveform graph. There are 4 scales available: x1, x2, x4 and x8.
- ◆ **Zoom-in** — displays the selected data graph in full screen.
- ◆ **Exit** — exits the waveform graph mode.
- **Full Screen Display** — this option is only available in the waveform graph mode, and mostly used in Graph Merge status for data comparison. There are three control buttons available on the top-right side of the screen under this mode.
 - ◆ **Edit** — opens an edit window, in which you can set the waveform color and the line thickness displayed for the selected parameter item.
 - ◆ **Scale** — changes the scale values, which are displayed below the waveform graph. There are 4 scales available: x1, x2, x4 and x8.
 - ◆ **Zoom-out** — exits full screen display.
 - ◆ **Exit** — exits the waveform graph mode.
- **To edit the waveform color and line thickness in a data graph**
 1. Select 1 to 3 parameter items to display in Waveform Graph mode.
 2. Tap the **Zoom-in** button on the right to display the data graph in full screen.
 3. Tap the **Edit** button, and an edit window displays.
 4. Select a parameter item on the left column.
 5. Select a desired sample color from the second column.
 6. Select a desired sample line thickness from the right column.

7. Repeat step 4-7 to edit the waveform for each parameter item.
8. Tap **Done** to save the setting and exit, or tap **Cancel** to exit without saving.

- **Digital Gauge Mode** — displays the parameters in form of a digital gauge graph.
- **Trigger Setting**

On the trigger setting screen, you can set a standard range by filling in a Minimum value and a Maximum value. When exceeding this range, the trigger function will be executed and the device will automatically record and save the generated data. You can check the saved live data by tapping the **Review** button at the bottom of the screen.

Tap the drop-down button on the right side of the parameter name to open a submenu. The **Trigger** button is the last one in the submenu. Tap to display the Trigger Setting dialog box.

Two buttons and two input boxes are available in the Trigger Setting dialog box.

- ◆ **Trigger** — switches the trigger on and off. The trigger is **ON** by default.
- ◆ **Buzzer alarm** — switches the alarm on and off. The alarm function makes a beep sound as an alert when the data reading reaches the preset minimum or maximum point. The buzzer alarm will only sound at the first trigger.
- ◆ **MIN** — displays a virtual keyboard to enter the required lower limit value.
- ◆ **MAX** — displays a virtual keyboard to enter the required upper limit value.

➤ **To set a trigger**

1. Tap the drop-down button on the right side of the parameter name to open a submenu.
2. Tap the **Trigger** button on the right side of the submenu to open the trigger settings dialog box.
3. Tap the **MIN** button on the right side, and enter the required minimum value.
4. Tap the **MAX** button on the right side, and enter the required maximum value.
5. Tap **OK** to save the setting and return to the Live Data screen; or tap **Cancel** to exit without saving.

When the trigger is successfully set, a trigger mark displays in front of the parameter name. The mark is gray when it is not triggered, and displays orange when triggered. Moreover, two horizontal lines display on each of the data graphs (when Waveform Graph Mode is applied) to indicate the alarm point. The limit lines are shown in different colors to differentiate them from the parameter waveforms.

⑤ Function Buttons

The operations of all the available function buttons on Live Data screen are described below:

- **Cancel All** — cancels all selected parameter items.
- **Show selected/Show all** — switches between the two options; one displays the selected parameter items, the other displays all the available items.
- **Graph merge** — merges selected data graphs (for Waveform Graph Mode only). This function is very useful when making comparison between different parameters.

NOTE

This mode supports Graph Merge for 2 to 3 parameter items only, so select no less than 2 or no more than 3 items each time when making graph merge.

To cancel Graph Merge mode, tap the drop-down button on the right side of the parameter name, and select a data display mode.

- **To top** — moves a selected data item to the top of the list.
- **Setting** — sets recording duration.
- **To set live data record duration**
 1. Tap **Setting** button at the bottom of the Live Data screen.
 2. Tap the > button to the right of **Recording time after trigger** bar and select a time length.
 3. Tap **OK** to save the setting and return to the Live Data Setting screen; or tap the X button at the upper right corner to exit without saving.
 4. Tap **Done** at the upper right corner of the Live Data Setting screen to confirm and save the setting, and return to the Live Data screen; or tap **Cancel** to exit without saving.
- **Clear data** — clears all previously retrieved parameter values at a cutting point whenever you choose.
- **Freeze** — displays the retrieved data in freeze mode.
 - ◆ **Resume** — exits the freeze data mode and return to normal data display.
 - ◆ **Previous frame** — moves to the previous frame in the freeze data.
 - ◆ **Play/Pause** — plays/pauses the frozen data.
 - ◆ **Next frame** — moves to the next frame in the freeze data.
- **Record** — starts recording the live data of the selected data items. Tap the **Record** button at the bottom of the Live Data screen. A message will display prompting user to select parameters to record. Tap **Got It** button to confirm. Scroll

down and select data to record. Tap the **Record** button to start recording. Tap **Resume** button to stop recording. The recorded live data can be viewed in the **Review** section at the bottom of the Live Data screen. The recorded data can also be reviewed in the Data Manager application.

- **Review** — review the recorded data. Tap the **Review** button to display a recording list, and select one item to review.

 **NOTE**

Only the data recorded during the current operation can be reviewed on the Live Data screen. All the historical recorded data can be reviewed in "Review Data" in the Data Manager application.

- **Previous Frame** — switches to the previous frame of recorded data.
 - **Next Frame** — switches to the next frame of recorded data.
 - **Play/Pause** — plays/pauses the recorded data.
 - **Show Selected** — displays the selected parameter items.
 - **Graph Merge** — merges selected data graphs.
 - **Back** — exits the review, and return to the Live Data screen.
- **Back** — returns you to the previous screen or exit the function.

4.5.6 Active Test

The Active Test function is used to access vehicle-specific subsystem and component tests. Available tests vary depending on the manufacturer, year, and model, and only the available tests display in the menu.

During an active test, the tester outputs commands to the ECU in order to drive the actuators. This test determines the integrity of the system or parts by reading the engine ECU data, or by monitoring the operation of the actuators, such as switching a solenoid, relay, or switch, between two operating states.

Selecting Active Test opens a menu of test options that varies by make and model. Selecting a menu option activates the test. Follow all screen instructions while performing tests. The content and pattern of the on-screen information vary according to the type of test being performed. Some toggle and variable control tests display Active Test Controls at the top of the screen with data stream information below, or vice versa.

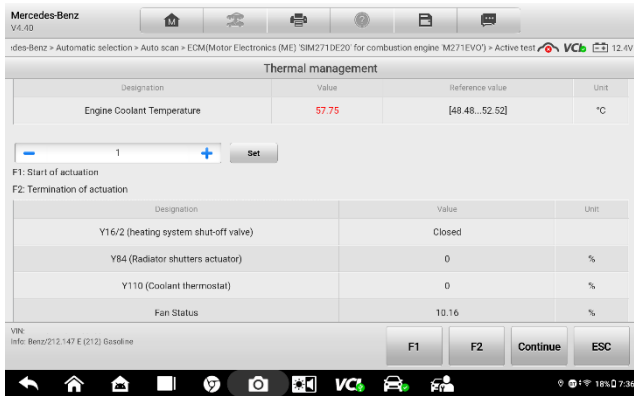

Figure 4-13 Sample Active Test Screen

The function buttons at the lower-right corner of the Active Test screen manipulate the test signals. The operational instructions are displayed on the main section of the test screen. Simply follow the on-screen instructions and make appropriate selections to complete the tests. Each time when an operation is successfully executed, message such as "Command Finished", "Activation Successful", or something similar displays.

Tap the **ESC** function button to exit the test when finished.

4.5.7 Special Functions

These functions perform various component adaptations, allowing you to recalibrate or configure certain components after making repairs or replacement.

The main section of the Adaptation Operation screen displays a list of operational and vehicle status information, which mainly consists of four parts:

- The first part in the top line shows the description of the operation being performed, and the execution status is displayed on the right, such as Completed, Activated, etc.
- The second part shows the preconditions or requirements for executing the operation being selected.
- The third part displays the current conditions of the vehicle control module being learned for comparison to the preconditions suggested by the second part. If the current condition of the control module is out of the suggested limit value, you must adjust the vehicle condition to meet the requirement.

- The last part displays the instruction of how to use the function button at the lower right corner of the screen to manipulate the teach-in operations.

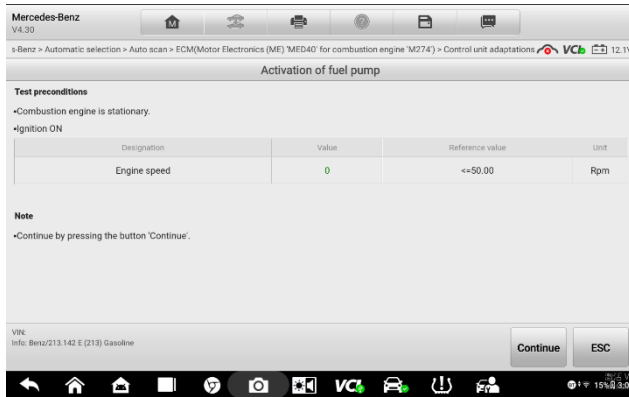

Figure 4-14 Sample Adaptation Operation Screen

Read the information carefully and check the vehicle condition accordingly, when you are sure that the vehicle is ready to perform the adaptation, simply follow the instruction provided to make appropriate selections. When the operation is done, an execution status message such as Completed, Finished or Successful, displays.

Tap the **ESC** button to exit the function.

4.6 Service

The Service section is specially designed to provide you with quick access to the vehicle systems for various scheduled service and maintenance performances. The typical service operation screen is a series of menu driven executive commands. By following the on-screen instructions to select appropriate execution options, enter correct values or data, and perform necessary actions, the system will guide you through the complete performance for various service operations.

The most commonly performed service functions include:

- Oil Reset Service
- TPMS Programming Service
- EPB Service
- ABS/SRS Services
- SAS Calibration Service
- DPF Regeneration Service

4.6.1 Function Descriptions

This section describes the main functions for vehicle service:

4.6.1.1 *Oil Reset Service*

This function allows you to perform reset for the Engine Oil Life system, which calculates an optimal oil life change interval depending on the vehicle driving conditions and climate. The Oil Life Reminder must be reset every time the oil is changed, so the system can calculate when the next oil change is required.

4.6.1.2 *Tire Pressure Monitor System (TPMS) Service*

This function allows you to quickly look up the tire sensor IDs from the vehicle's ECU, as well as to perform TPMS programming and reset procedures after tire sensors are replaced.

4.6.1.3 *Electric Parking Brake (EPB) Service*

This function has a multitude of usages to maintain the electronic braking system safely and effectively. The applications include deactivating and activating the brake control system, assisting with brake fluid control, opening and closing brake pads, and setting brakes after disc or pad replacement, etc.

4.6.1.4 *ABS/SRS Services*

This function allows you to perform various bi-directional tests to check the operating conditions of both the Anti-lock Braking System and the Supplemental Restraint System, such as Automated Bleeding, Pump Motor Test, and checking Module information, etc.

4.6.1.5 *Steering Angle Sensor (SAS) Service*

This service function allows you to perform calibration for the Steering Angle Sensor, which permanently stores the current steering wheel position as the straight-ahead position in the steering angle sensor EEPROM. On successful completion of the calibration, the steering angle sensor fault memory is automatically cleared.

4.6.1.6 *DPF Regeneration Service*

The Diesel Particulate Filter service function performs the regeneration procedure which is the DPF cleaning operation to clear the blockage through continuous burning of the particulate matter captured in the DPF filter. If the DPF light on the vehicle comes on and you successfully complete a DPF regeneration cycle, you will notice that the DPF light will automatically turn off.

4.7 Generic OBDII Operations

A fast-access option for OBDII/EODB vehicle diagnosis is available on the Vehicle Menu screen (see [Figure 4-1 Sample Vehicle Menu Screen](#)). This option presents a quick way to check for DTCs, isolate the cause of an illuminated malfunction indicator lamp (MIL),

check monitor status prior to emissions certification testing, verify repairs, and perform a number of other services that are emissions-related. The OBD direct access option is also used for testing OBDII/EOBD compliant vehicles that are not included in the Diagnostics database.

Functions of the diagnostics toolbar buttons at the top of the screen are the same as those available for specific vehicle diagnostics. See [Figure 4-2 Sample Vehicle Diagnostics Screen](#) on page 21 for details.

4.7.1 General Procedures

➤ To access the OBDII/EOBD diagnostics functions

1. Tap the **Diagnostics** application from the OTOFIX Job Menu. The Vehicle Menu displays.
2. Tap the **EOBD** button. There are two options to establish communication with the vehicle.
 - **Auto Scan** — when this option is selected the diagnostics tool attempts to establish communication using each protocol in order to determine which one the vehicle is broadcasting on.
 - **Protocol** — when this option is selected the screen opens a submenu of various protocols. A communication protocol is a standardized way of data communication between an ECM and a diagnostics tool. Global OBD may use several different communication protocols.
3. Select a specific protocol under the **Protocol** option. Wait for the OBDII Diagnostics Menu to appear.

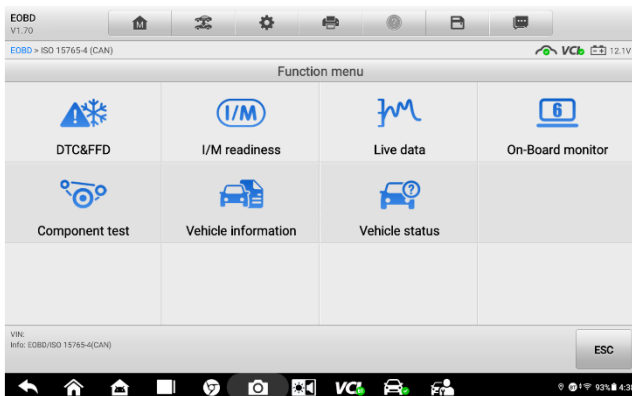

Figure 4-15 Sample OBDII Diagnostics Menu

4. Select a function option to continue.
 - **DTC & FFD**

- **I/M readiness**
- **Live data**
- **On-Board monitor**
- **Component test**
- **Vehicle information**
- **Vehicle status**

 **NOTE**

Some functions are supported only on certain vehicle makes.

4.7.2 Function Descriptions

This section describes the various functions of each diagnostics option:

4.7.2.1 DTC & FFD

When this function is selected, the screen displays a list of Stored Codes and Pending Codes. When the Freeze Frame data of certain DTCs are available for viewing, a snowflake button will display on the right side of the DTC item. The Erase Codes function can be applied by tapping the function button at the lower bottom of the screen.

- **Stored Codes**

Stored codes are the current emission related DTCs from the ECM of the vehicle. OBDII /EOBD Codes have a priority according to their emission severity, with higher priority codes overwriting lower priority codes. The priority of the code determines the illumination of the MIL and the codes erase procedure. Manufacturers rank codes differently, so expect to see differences between makes.

- **Pending Codes**

These are codes whose setting conditions were met during the last drive cycle, but need to be met on two or more consecutive drive cycles before the DTC actually sets. The intended use of this service is to assist the service technician after a vehicle repair and after clearing diagnostics information, by reporting test results after a driving cycle.

- 1) If a test failed during the driving cycle, the DTC associated with that test is reported. If the pending fault does not occur again within 40 to 80 warm-up cycles, the fault is automatically cleared from memory.
- 2) Test results reported by this service do not necessarily indicate a faulty component or system. If test results indicate another failure after additional driving, then a DTC is set to indicate a faulty component or system, and the MIL is illuminated.

- **Freeze Frame**

In most cases the stored frame is the last DTC that occurred. Certain DTCs, which have a greater impact on vehicle emission, have a higher priority. In these cases, the top prioritized DTC is the one for which the freeze frame records are retained. Freeze frame data includes a "snapshot" of critical parameter values at the time the DTC is set.

- **Erase Codes**

This option is used to clear all emission related diagnostics data such as, DTCs, freeze frame data and manufacturer specific enhanced data from the vehicle's ECM, and reset the I/M Readiness Monitor Status for all vehicle monitors to Not Ready or Not Complete status.

A confirmation screen displays when the clear codes option is selected to prevent accidental loss of data. Select **Yes** on the confirmation screen to continue or **No** to exit.

4.7.2.2 *I/M Readiness*

This function is used to check the readiness of the monitoring system. It is an excellent function to use prior to having a vehicle inspected for compliance to a state emissions program. Selecting I/M Readiness opens a submenu with two choices:

- **Since DTCs Cleared** — displays the status of monitors since the last time the DTCs are erased.
- **This Driving Cycle** — displays the status of monitors since the beginning of the current drive cycle.

4.7.2.3 *Live Data*

This function displays the real time PID data from ECU. Displayed data includes analog inputs and outputs, digital inputs and outputs, and system status information broadcast on the vehicle data stream.

Live data can be displayed in various modes, see [Live Data](#) on page 34 for detailed information.

4.7.2.4 *On-Board Monitor*

This option allows you to view the results of On-Board Monitor tests. The tests are useful after servicing or after erasing a vehicle's control module memory.

4.7.2.5 *Component Test*

This service enables bi-directional control of the ECM so that the diagnostics tool is able to transmit control commands to operate the vehicle systems. This function is useful in determining whether the ECM responds to a command well.

4.7.2.6 Vehicle Information

The option displays the vehicle identification number (VIN), the calibration identification, and the calibration verification number (CVN), and other information of the vehicle.

4.7.2.7 Vehicle Status

This item is used to check the current condition of the vehicle, including communication protocols of OBDII modules, retrieved codes amount, status of the Malfunction Indicator Light (MIL), and other additional information.

4.8 Exiting Diagnostics

The Diagnostics application remains open as long as there is an active communication with the vehicle. You must exit the diagnostics operation interface to stop all communications with the vehicle before closing the Diagnostics application.

NOTE

Damage to the vehicle electronic control module (ECM) may occur if communication is disrupted. Make sure all connections, such as USB cable and wireless connection, are properly connected at all times during testing. Exit all tests before disconnecting the test connection or powering down the tool.

➤ To exit the Diagnostics application

1. From an active diagnostics screen, tap the **Back** or **ESC** function button to exit a diagnostics session step-by-step; Or tap the **Vehicle Swap** button on the diagnostics toolbar to return to the Vehicle Menu screen.
2. From the Vehicle Menu screen, tap the **Home** button on the top toolbar; or tap the **Back** button on the navigation bar at the bottom of the screen. Or tap the **Home** button on the diagnostics toolbar to exit the application directly and go back to the OTOFIX Job Menu.

Now, the Diagnostics application is no longer communicating with the vehicle and it is safe to open other OTOFIX applications, or exit the OTOFIX diagnostics system and return to the Home screen.

5 Service

The Service application is specially designed to provide quick access to the vehicle systems for various scheduled service and maintenance tasks. The typical service operation screen is a series of menu driven executive commands. Follow on-screen instructions to select appropriate execution options, enter correct values or data, and perform necessary actions. The application will display detailed instructions to complete selected service operations.

After entering each special function, the screen will display two application parts: **Diagnosis** and **Hot functions**. The **Diagnosis** enables the reading and clearing of codes which is sometimes necessary after completing certain special functions. **Hot Functions** consists of sub functions of the selected special function.

Several most commonly used services are described in this chapter.

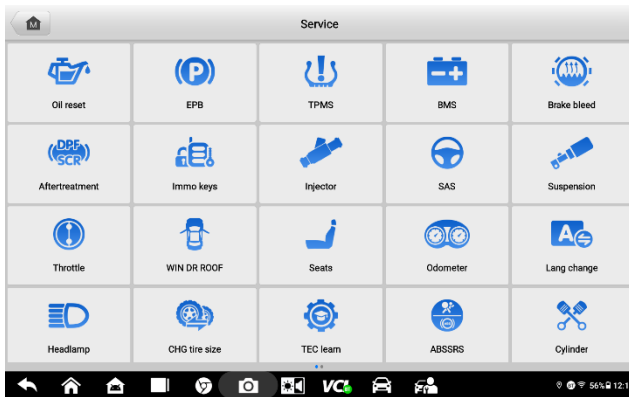

Figure 5-1 Sample Service Menu

5.1 Oil Reset

Perform reset for the Engine Oil Life system, which calculates an optimal oil life change interval depending on the vehicle driving conditions and climate. The Oil Life Reminder must be reset each time the oil is changed, so the system can calculate when the next oil change is required.

NOTE

- Always reset the engine oil life to 100% after every oil change.
 - All required work must be carried out before the service indicators are reset. Failure to do so may result in incorrect service values and cause DTCs to be stored by the relevant control module.
 - For some vehicles, the scan tool can reset additional service lights such as maintenance cycle and service interval. On BMW vehicles for example, service resets include engine oil, spark plugs, front/rear brakes, coolant, particle filter, brake fluid, micro filter, vehicle inspection, exhaust emission inspection and vehicle checks.
-

5.2 Electric Parking Brake (EPB)

This function has a multitude of usages to maintain the electronic braking system safely and effectively. The applications include deactivating and activating the brake control system, assisting with brake fluid control, opening and closing brake pads, and setting brakes after disc or pad replacement.

5.2.1 EPB Safety

It can be dangerous to perform Electric Parking Brake (EPB) system maintenance, so before you begin the service work, please keep these rules in mind.

- ✓ Ensure that you are fully familiar with the braking system and its operation before commencing any work.
 - ✓ The EPB control system may be required to be deactivated before carrying out any maintenance/diagnostics work on the brake system. This can be done from the tool menu.
 - ✓ Only perform maintenance work when the vehicle is stationary and on level ground.
 - ✓ Ensure that the EPB control system is reactivated after the maintenance work has been completed.
-

NOTE

Autel accepts no responsibility for any accident or injury arising from the maintenance of the Electric Parking Brake system.

5.3 Tire Pressure Monitoring System (TPMS)

This function allows you to quickly look up the tire sensor IDs from the vehicle's ECU, as well as to perform TPMS replacement and reset procedures after tire sensors are replaced.

5.4 Battery Management System (BMS)

The Battery Management System (BMS) allows the tool to evaluate the battery charge state, monitor the close-circuit current, register the battery replacement, activate the rest state of the vehicle, and charge the battery via the diagnostics socket.

NOTE

- This function is not supported by all vehicles.
- The sub functions and actual test screens of the BMS may vary by vehicle, please follow the on-screen instructions to make correct option selection.

The vehicle may use either a sealed lead-acid battery or an AGM (Absorbed Glass Mat) battery. Lead acid battery contains liquid sulphuric acid and can spill when overturned. AGM battery (known as VRLA battery, valve regulated lead acid) also contains sulphuric acid, but the acid is contained in glass mats between terminal plates.

It is recommended that the replacement aftermarket battery has the same specifications, such as capacity and type, as the exiting battery. If the original battery is replaced with a different type of battery (e.g. a lead-acid battery is replaced with an AGM battery) or a battery with a different capacity (mAh), the vehicle may require reprogramming of the new battery type, in addition to, performing the battery reset. Consult the vehicle manual for additional vehicle-specific information.

5.5 Immobilizer (IMMO) Keys

An immobilizer is an anti-theft mechanism that prevents an automobile's engine from starting unless the correct ignition key or other device is present. This device prevents thieves from starting the car by a method known as hot wiring. Most new vehicles have an immobilizer as standard equipment. An important advantage of this system is that it doesn't require the car owner to activate it; it operates automatically. An immobilizer is considered as providing much more effective anti-theft protection than an audible alarm alone; many auto insurance companies offer lower rates for vehicles that are equipped with an immobilizer.

As an anti-theft device, an immobilizer disables one of the systems needed to start a car's engine, usually the fuel supply or the ignition. This is accomplished by radio frequency identification between a transponder in the ignition key and a device called a radio frequency reader in the steering column. When the key is placed in the ignition, the transponder sends a signal with a unique identification code to the reader, which relays

it to a receiver in the vehicle's computer control module. If the code is correct, the computer allows the fuel supply and ignition systems to operate and start the car. If the code is incorrect or absent, the computer disables the system, and the car will be unable to start until the correct key is placed in the ignition.

The IMMO Keys service can disable a lost vehicle key and program the replacement key fob. One or more replacement key fobs can be programmed.

5.6 Steering Angle Sensor (SAS)

The SAS Calibration permanently stores the current steering wheel position as the straight-ahead position in the steering angle sensor EEPROM. Therefore, the front wheels and the steering wheel must be set exactly to the straight-ahead position before calibration. In addition, the vehicle identification number (VIN) is also read from the instrument cluster and stored permanently in the steering angle sensor EEPROM. On successful completion of calibration, the steering angle sensor fault memory is automatically cleared.

Calibration must always be carried out after the following operations:

- Steering wheel replacement
- Steering angle sensor replacement
- Any maintenance that involves opening the connector hub from the steering angle sensor to the column
- Any maintenance or repair work on the steering linkage, steering gear or other related mechanism
- Wheel alignment or wheel track adjustment
- Accident repairs where damage to the steering angle sensor or assembly, or any part of the steering system may have occurred

NOTE

- Autel accepts no responsibility for any accident or injury arising from servicing the SAS system. When interpreting DTCs retrieved from the vehicle, always follow the manufacturer's recommendation for repair.
 - All software screens shown in this manual are examples, actual test screens may vary by the vehicle. Pay attention to the menu titles and onscreen instructions to make correct option selections.
 - Before starting procedure, make sure vehicle has an **ESC** button. Look for button on dash.
-

6 Battery Test

The OTOFIX BT1 Lite (hereinafter referred to as BT1 Lite) is a battery and electrical system analysis tool that uses adaptive conductance, an advanced battery analysis method to produce a more accurate examination of the battery's cold cranking ability and reserve capacity, which is vital to determining a battery's true health. The BT1 Lite enables technicians to view the health status of the vehicle's battery and electrical system. Together with the BT1 Lite, this application can complete battery & starting and charging system tests and display the test results.

6.1 OTOFIX BT1 Lite Tester

6.1.1 Function Descriptions

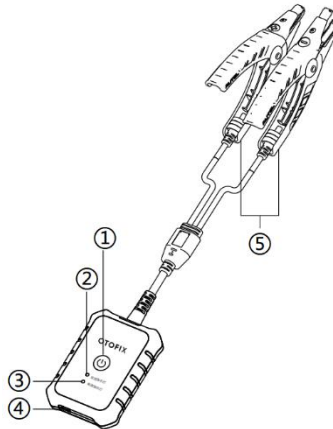

Figure 6-1 BT1 Lite Tester

- ① Power Button
- ② Status LED
- ③ Power LED
- ④ USB Port
- ⑤ Battery Clamp Cable

Table 6-1 LED Description

LED	Color	Description
Status LED	Green	<ul style="list-style-type: none">● Lights green when the tester is connected to the tablet via USB cable.● Flashes green when the tester is communicating via USB cable.
	Blue	<ul style="list-style-type: none">● Lights blue when the tester is connected to the tablet via bluetooth.● Flashes blue when the tester is communicating via bluetooth.
	Red	<ul style="list-style-type: none">● Lights red when the battery clamps are connected to the wrong battery terminals.
Power LED	Green	<ul style="list-style-type: none">● Lights green when the tester is powered on and the battery is sufficiently charged.● Flashes green when the tester is charging.
	Red	<ul style="list-style-type: none">● Flashes red when the battery level is low.● Please charge the device.

6.1.2 Power Sources

The BT1 Lite tester can receive power from the following sources:

- Internal battery pack
- AC/DC power supply

! IMPORTANT

Do not charge the battery when the temperature is below 0 °C (32 °F) or above 45 °C (113 °F).

Internal Battery Pack

The BT1 Lite tester can be powered with the internal rechargeable battery.

AC/DC Power Supply — Using Power Adapter

The BT1 Lite tester can be powered from an electrical outlet using the AC/DC power adapter. The AC/DC power supply also charges the internal battery.

6.1.3 Technical Specifications

Table 6-2 Technical specifications

Item	Description
Connectivity	<ul style="list-style-type: none">● Type-C USB● Bluetooth 4.2
Input Voltage	5 V DC
Working Current	< 150 mA at 12 V DC
Internal Battery	3.7 V/800 mAh lithium-ion polymer battery
CCA Range	100 to 2000 A
Voltage Range	1.5 to 16 V
Working Temperature	-10 to 50 °C (14 to 122 °F)
Storage Temperature	-20 to 60 °C (-4 to 140 °F)
Dimension (L x W x H)	109.2 mm (4.30") x 77.5 mm (3.05") x 24.8 mm (0.98") (clamp cable not included)
Weight	319.2 g

6.2 Test Preparation

6.2.1 Inspecting the Battery

Before starting a test, inspect the battery for:

- Cracking, buckling or leaking (If you see any of these defects, replace the battery.)
- Corroded, loose or damaged cables and connections (Repair or replace as needed.)
- Corrosion on the battery terminals, and dirt or acid on the case top (Clean the case and terminals using a wire brush and a mixture of water and baking soda.)

6.2.2 Establishing Communication

➤ **To connect BT1 Lite with D1 Plus/Max**

1. Turn on both BT1 Lite and D1 Plus/Max.
2. Tap the **VCI Manager** application on the OTOFIX Job Menu of the D1 Plus/Max, and tap **BAS BT**.
3. Tap **Scan** at the upper right corner of the tablet's screen.
4. The device name may display as Maxi suffixed with a serial number. Select the appropriate device for pairing.

5. When paired successfully, the connection status displays the device name with the message **Connected**.
6. Once paired, the Connection LED on the BT1 Lite illuminates blue. This signifies that the tablet is connected to the BT1 Lite, and is ready to for use.

6.2.3 Connecting to a Battery

➤ **To connect to a battery**

1. Press and hold the **Power** button to turn on the BT1 Lite tester.
2. Connect the red clamp to the positive (+) terminal and the black clamp to the negative (-) terminal of the battery.

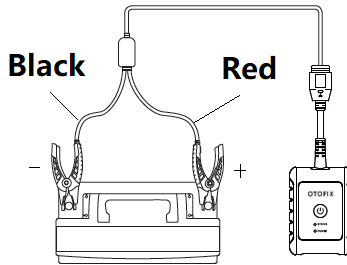

Figure 6-2 Connecting to a Battery

3. The black clamp is installed with an infrared sensor near the clamp mouth that tests the battery temperature. The battery temperature will appear on the Battery Test Result screen or in the Battery Test Report.

6.3 In-vehicle Test

In-vehicle Test is used for testing batteries that are installed in a vehicle. An in-vehicle test includes battery test, starter test, and generator test. These tests help determine the health status of the battery, the starter, and the generator, respectively.

❗ IMPORTANT

Before using the diagnostics functions, download the desired vehicle software on the **Update** screen.

🔗 NOTE

The complete in-vehicle test includes battery test, starter test and generator test, in sequence.

6.3.1 Battery Test

➤ **To perform the in-vehicle battery test**

1. Tap the **Battery Test** application on the OTOFIX Job Menu. The **Battery Test** screen displays.

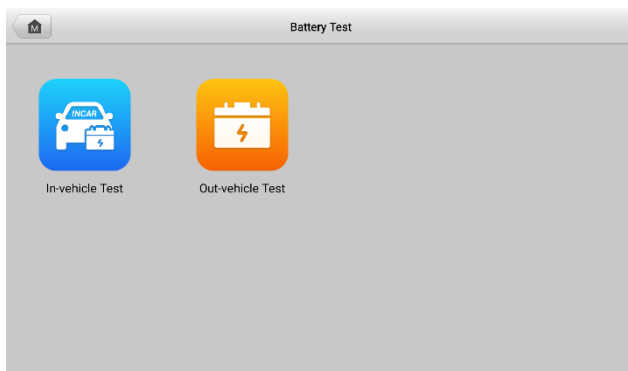

Figure 6-3 Battery Test Screen

2. Tap **In-vehicle Test**.
3. (Optional) Establish communications between the VCI and vehicle by following the on-screen instructions on the OBD connect screen.

🔗 NOTE

OBD connect is recommended and is used for automatically obtain battery type and location.



Figure 6-4 Screen OBD Connect Screen

4. Confirm the vehicle information. The Vehicle information screen automatically displays when vehicle communication is established. A **Battery location** button will pop up from the bottom of the screen.

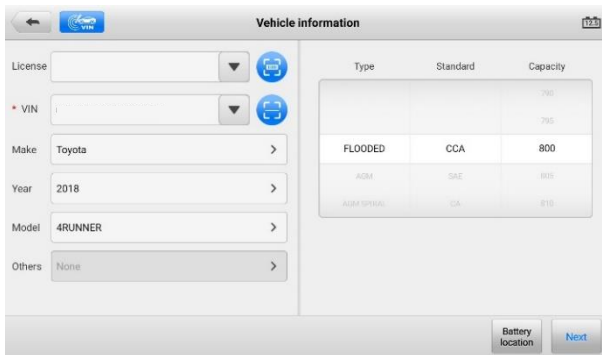





Figure 6-5 Sample Vehicle Information

Table 6-3 Upper Toolbar Buttons

Button	Name	Description
	Back	Returns to the previous screen.
	VIN Scan	Opens a dropdown list; tap Auto detect for auto VIN detection; tap Manual input to enter VIN manually; tap Scan VIN/License to scan the VIN code/license numbers by camera.
	Battery Connection	Displays the battery connection status. The number on the icon indicates the real-time voltage of the tested battery.

5. Tap **Next** and access the Battery tab. Perform required operations before the battery test based on the on-screen instructions. And tap the **Start Testing** button.

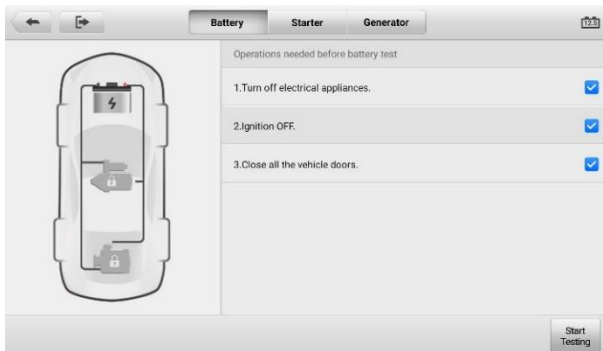

Figure 6-6 Sample Battery Screen

6. Wait for the battery test to complete and view the test results.



Figure 6-7 Sample Battery Test Results Screen

Possible in-vehicle test results are as follows:

- Good Battery
- Good & Recharge
- Charge & Retest
- Replace Battery
- Bad Cell

6.3.2 Starter Test

➤ **To perform the starter test**

1. Tap **Continue**. Perform required operations before the battery test based on the on-screen instructions. And tap the **Start Testing** button.

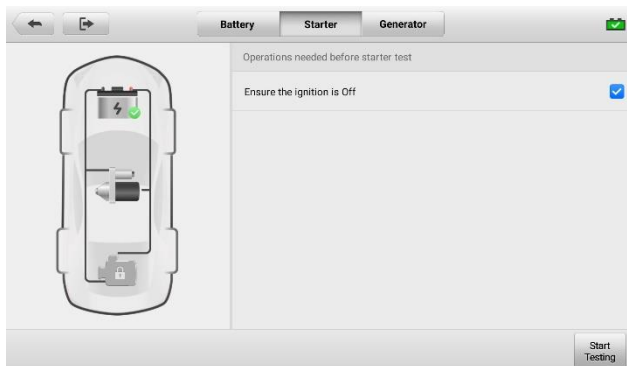

Figure 6-8 Sample Starter Screen 1

2. Turn the vehicle ignition to **ON** when the following screen appears.

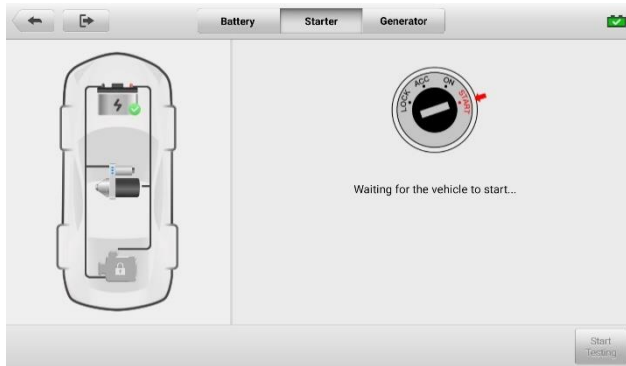

Figure 6-9 Sample Starter Screen 2

3. Wait for the test to complete and view the test results.

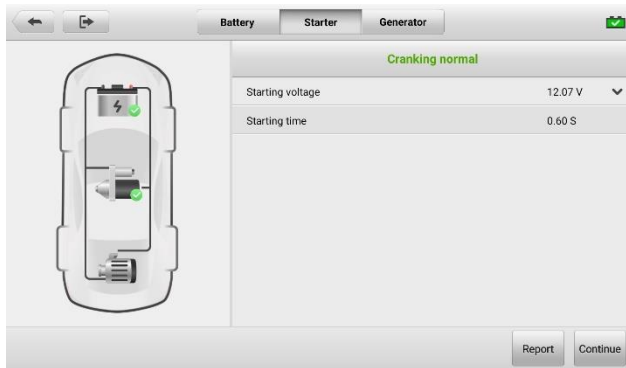

Figure 6-10 Sample Starter Test Result Screen

Possible starter test results are as follows:

- Cranking Normal
- Current Too Low
- Voltage Too Low
- Not Started

6.3.3 Generator Test

➤ To perform the generator test

1. Tap **Continue**. Perform required operations based on the on-screen instructions.

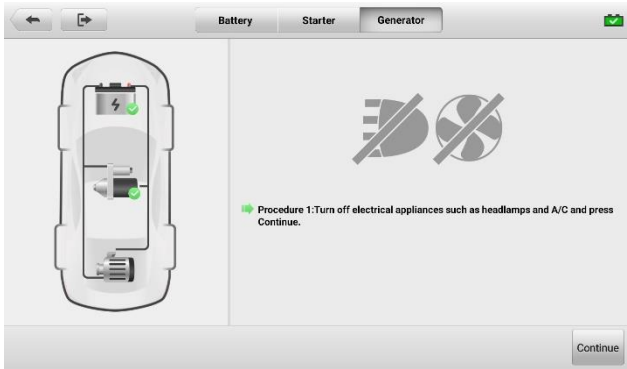

Figure 6-11 Sample Generator Test Screen

2. Tap **Continue** and view the test results.

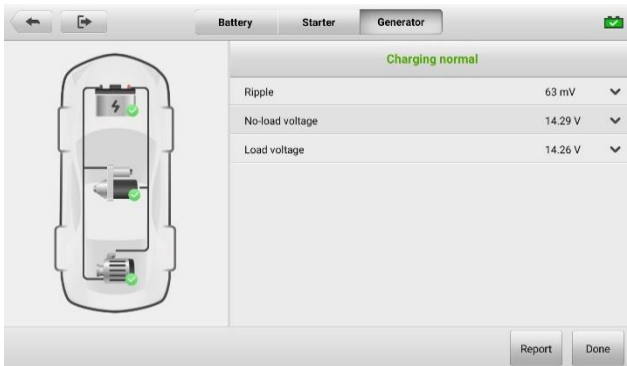

Figure 6-12 Sample Generator Test Result Screen

Possible generator test results are as follows:

- Charging Normal
- Output Too Low
- Output Too High
- Ripple Too Large
- No Output

6.4 Out-vehicle Test

Out-vehicle test is used to test the condition of batteries that are not connected to a vehicle. This function aims to check the health status of the battery only. The battery types and standards able to be tested are as follows:

Types: FLOODED, AGM, AGM SPIRAL, EFB, and GEL

Standards: CCA, SAE, CA, EN, IEC, DIN, JIS and MCA

6.4.1 Battery Test

➤ **To perform the out-vehicle battery test**

1. Tap the **Battery Test** application on the OTOFIX Job Menu. The Battery Test screen displays (see [Figure 6-3 Battery Test Screen](#)).
2. Tap **Out-vehicle Test**.
3. Check the battery information and tap **Start Testing**.

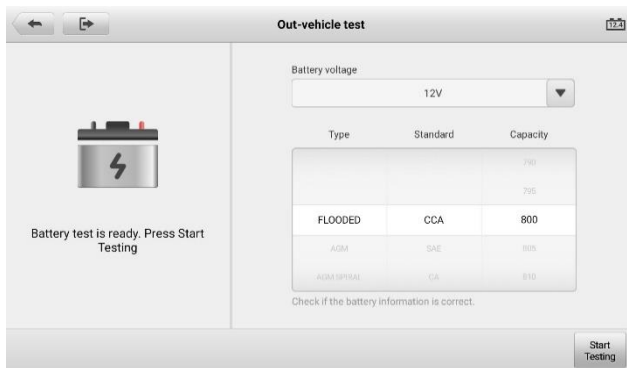

Figure 6-13 Sample Out-vehicle Test Screen

4. Wait for the battery test to complete and view the test results.

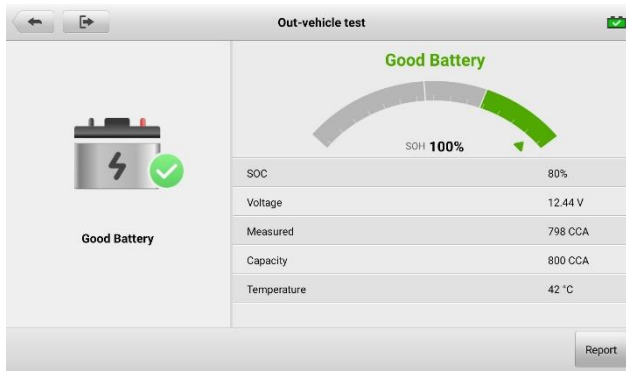

Figure 6-14 Sample Out-vehicle Test Result Screen

Possible out-vehicle test results are as follows:

- Good Battery
- Good & Recharge
- Charge & Retest
- Replace Battery
- Bad Cell

7 Settings

Access the Settings menu to adjust OTOFIX system settings and view information about the OTOFIX system. The following options are available for the OTOFIX system settings:

- **Unit**
- **Language**
- **Printing settings**
- **Scan report**
- **Auto update**
- **Vehicle list**
- **System settings**
- **About Us**

This section describes the operation procedures for the settings.

7.1 Unit

This option allows you to adjust the measurement unit for the diagnostics system.

➤ **To adjust the unit setting**

1. Tap **Settings** on the OTOFIX Job Menu.
2. Tap **Unit** on the left column.
3. Select the appropriate units of measurement: metric unit or imperial unit. A check mark will display to the right of the selected unit.
4. Tap the **Home** button on the top-left corner to return to the OTOFIX Job Menu. Or select another Settings option for the system setup.

7.2 Language

This option allows you to adjust the display language for the OTOFIX system.

➤ **To adjust the language setting**

1. Tap **Settings** on the OTOFIX Job Menu.
2. Tap **Language** on the left column.
3. Select the desired language. A check mark will display to the right of the selected language.
4. Tap the **Home** icon on the top-left corner to return to the OTOFIX Job Menu, or select another setting option for the system setup.

7.3 Printing Settings

7.3.1 Printer Settings

This option allows you to print from the tablet to a network printer via network.

➤ **To setup the printer connection**

1. Tap **Settings** on the OTOFIX Job Menu.
2. Tap **Printing settings** on the left column.
3. Tap **Print via network** to enable the printing function, which enables the tablet to send files to the printer through the PC via Wi-Fi or Ethernet connection.
4. Tap the **Home** icon on the top-left corner to return to the OTOFIX Job Menu, or select another setting option for the system setup.

7.3.2 Printing Operations

➤ **To install the MaxiSys Printer driver program**

1. Download **Maxi PC Suite** from www.otofixtech.com > **Support Center** > **Downloads** > **Diagnostic Tool** and install to your PC.
2. Double click the **setup.exe** file.
3. Select the installation language and the wizard will load momentarily.
4. Follow the instructions on the screen and click **Next** to continue.
5. Click **Install**. The printer driver program will be installed onto the PC.
6. Click **Finish** to complete the installation.

 **NOTE**

The MaxiSys Printer runs automatically after the installation.

This section describes how to receive file from the OTOFIX tablet and print the file using the PC.

 **NOTE**

- Make sure the tablet is connected to the PC network, either via Wi-Fi or LAN, before printing.
 - Make sure the PC installed with the Printing Services program is connected to a printer.
-

 **To print a file using the PC**

1. Run the **MaxiSys Printer** program on the PC.
2. Click **Test Print** to make sure the printer is working successfully.
3. Tap the **Print** button on the toolbar of the tablet. A test file will be sent to the PC.
 - If the **Auto Print** option in the MaxiSys Printer is selected, the MaxiSys Printer will print the received file automatically.
 - If the **Auto Print** option is not selected, click **Open PDF File** to view files. Select the file(s) to print and click **Print**.

7.4 Scan Report

This option automatically synchronizes the diagnostics information of the vehicle to the vehicle history and forms a diagnostics report for user to upload. Tap the **ON/OFF** button to enable/disable the Scan Report or Report Upload to Cloud function. The button displays blue if the function is enabled and displays gray if the function is disabled.

7.5 Auto Update

This option allows you to set the specific time for automatically updating software. There are three update options: **OS Update**, **OTOFIX Update** and **Vehicle Update**.

Tap the **ON/OFF** button to enable/disable the Auto Update function. The button displays blue if Auto Update is enabled and displays gray if the Auto Update is disabled. Set the time of the day for updating. If the update time is set, the selected software will be automatically updated at configured time.

7.6 Vehicle List

This option allows you to sort the vehicles either by alphabetic order or by frequency of use.

➤ **To adjust the vehicle list setting**

1. Tap **Settings** on the OTOFIX Job Menu.
2. Tap **Vehicle list** on the left column.
3. Select the desired sort type. A check mark will display to the right of the selected item.
4. Tap the **Home** icon on the top-left corner to return to the OTOFIX Job Menu, or select another setting option for the system setup.

7.7 System Settings

This function provides you with direct access to the Android system setting interface, where you can adjust various system settings for the Android system platform, regarding wireless and networks settings, various device settings such as sound and display, as well as system security settings, and check related information about the Android system. Refer to Android documentation for additional information.

7.8 About Us

The About Us function provides information of the D1 Plus/Max including the product name, version, hardware, and serial number.

➤ **To check the D1 Plus/Max information in About**

1. Tap the **Settings** application on the OTOFIX Job Menu.
2. Tap the **About Us** option on the left column. The product information screen displays on the right.
3. Tap the **Home** icon on the top-left corner to return to the OTOFIX Job Menu, or select another setting option for the system setup.

8 Software Updates

The Update application allows you to download the latest released software. The updates can improve the OTOFIX applications' capabilities, typically by adding new tests, new models, or enhanced applications to the database.

Before updating the OTOFIX applications, follow the instructions below to log in to your account.

➤ **To log in with your account**

1. Turn on the D1 Plus/Max and ensure the tablet is connected to a power source with stable access to the Internet.
2. Tap the **Update** application from the OTOFIX Job Menu.



Figure 8-1 Sample OTOFIX Registration Screen

3. Enter your Autel ID and password and tap **Log In**.

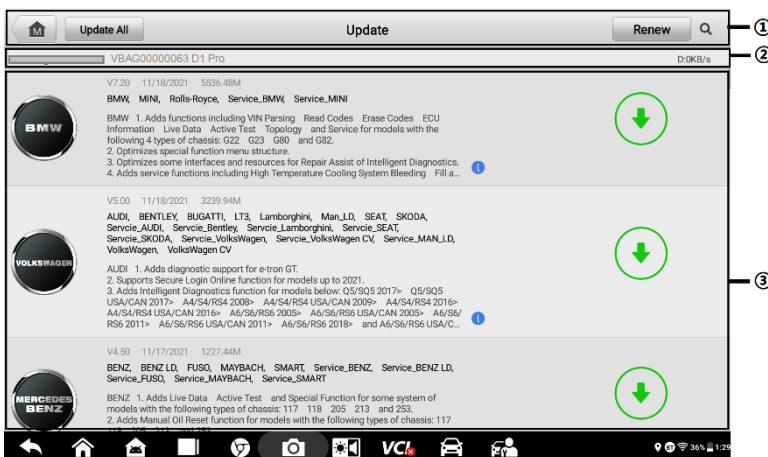

Figure 8-2 Sample Update Screen

① Navigation and Controls

- **Home** — returns to the OTOFIX Job Menu.
- **Update All** — updates all available updates.
- **Renew** — renews the available update list.
- **Search** — searches specific update item by entering the file name, for example: a vehicle make.

② Status Bar

- **Left Side** — displays the OTOFIX device model information and serial number.
- **Right Side** — displays an update progress bar indicating the completion status.

③ Main Section

- **Left Column** — displays vehicle logos and update software version information.
- **Middle Column** — displays a brief introduction about the new changes to the software operation or capabilities. Tap the **i** button to open an information screen to view more details, and tap the dim area around to close the window.
- **Right Column** — according to the operation status of each software item, the button displays differently.
 - a) Tap **Update** to update the selected item.
 - b) Tap **Pause** to suspend the updating procedure.
 - c) Tap **Continue** to go on updating the suspended update.

➤ **To update the diagnostic software**

1. Make sure the tablet is connected to a power source with stable access to the Internet.
2. Tap the **Update** application from the OTOFIX Job Menu.
3. Check all available updates:
 - If you decide to update all the items of diagnostics software, select Diagnostics tab and then tap the **Update All** button.
 - If you only want to update one or some of the item(s), tap the **Update** button on the right column of the specific item(s).
4. Tap the **Pause** button to suspend the updating process. When you tap **Continue** to renew the update, the updating process will resume from the break point.
5. When the updating process is completed, the software will be installed automatically. The previous version will be replaced.

9 Data Manager

The Data Manager application allows you to store, print, and review the saved files, manage the workshop information, customer information records and keep vehicle history records.

Tapping the Data Manager application opens the file system menu. There are nine main functions available.

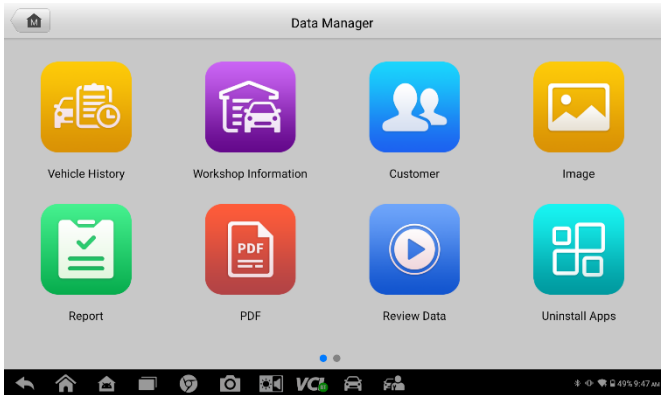











Figure 9-1 Sample Data Manager Main Screen

The table below briefly describes each of the function buttons in the Data Manager application.

Table 9-1 Buttons in Data Manager

Button	Name	Description
	Vehicle History	Review the diagnostics history record.
	Workshop Information	Edit the information of workshops.
	Customer	Create new customer information.
	Image	Review the screenshots.
	Report	Review the report list.
	PDF	Review the diagnostics reports.
	Review Data	Review the recorded data.

Button	Name	Description
	Uninstall Apps	Uninstall applications.
	Data Logging	Review the communication data and ECU information of the vehicle. The saved data can be reported and sent to the technical center via the Internet.

9.1 Vehicle History

This function stores records of vehicle history, including vehicle information and the retrieved DTCs from previous diagnostics sessions. Test information is summarized and displayed in an easy-to-read table listing. The Vehicle History also provides direct access to the previously tested vehicle and allows you to directly restart a diagnostics session without needing to perform auto or manual vehicle selection.

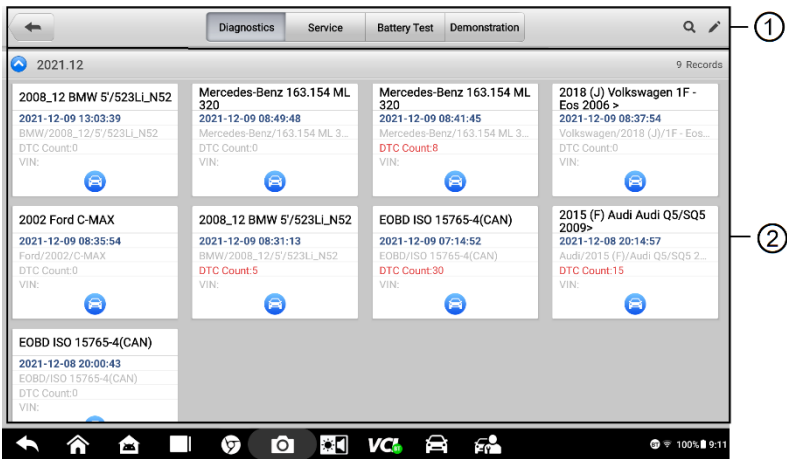

Figure 9-2 Sample Vehicle History Screen

① Top Toolbar Buttons — displays navigation and application controls.

② Main Section — displays all the vehicle history records.

➤ **To activate a test session for the recorded vehicle**

1. Tap **Data Manager** on the OTOFIX Job Menu.
2. Tap **Vehicle History** to open the screen. Tap the **Diagnostics** or **Service** tab to select diagnostics test records or service test records.
3. Tap **Diagnostics** icon at the bottom of the thumbnail of a vehicle record item.
4. The Diagnostics screen of the vehicle displays and a new diagnostics session Recorded Test History, see [Diagnostics](#) for detailed Recorded Test History for

each instructions on vehicle diagnostics operations. Or,

5. Select a vehicle thumbnail. A historical test record screen appears. Review the recorded information of the vehicle, and tap the **Diagnostics** button on the upper right corner to continue diagnostics.

9.1.1 Historical Test Record

The historical test record is a detailed data form of the tested vehicle, which includes general vehicle information, service record, customer information, and the diagnostics trouble codes retrieved from the previous test sessions. Technician notes will also appear if present.

NOTE

The D1 Plus/Max tablet must establish connection to the VCI device to restart test sessions on the previously tested vehicles.

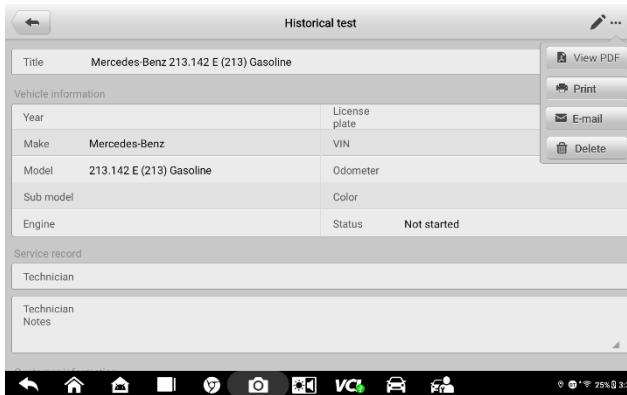

The screenshot shows a tablet interface titled "Historical test". At the top, the title is "Mercedes-Benz 213.142 E (213) Gasoline". Below this is a table of vehicle information. To the right of the table are buttons for "View PDF", "Print", "E-mail", and "Delete". Below the table is a "Service record" section with a "Technician" field and a "Technician Notes" field. At the bottom is a dock with various icons, including a VCI icon, and a status bar showing 25% battery and 3:33.

Vehicle information	
Year	License plate
Make Mercedes-Benz	VIN
Model 213.142 E (213) Gasoline	Odometer
Sub model	Color
Engine	Status Not started

Figure 9-3 Sample Historical Test Record Sheet

To edit the Historical Test record

1. Tap **Data Manager** on the OTOFIX Job Menu.
2. Tap **Vehicle History**.
3. Select the specific vehicle history record thumbnail from the main section. The Historical Test screen will display.
4. Tap **Edit** (a pen icon) to start editing.
5. Enter required information or attach files or images.

NOTE

The vehicle VIN, license number and customer information are correlated by default. Vehicle records will automatically be correlated using this vehicle and customer identification.

6. Tap **Add to customer** to correlate the historical test record sheet to existing customer information or new added customer information. See [Customer](#) on page 74 for more information.
7. Tap **Done** to save the updated record, or tap **Cancel** to exit without saving.

9.2 Workshop Information

The Workshop Information screen allows you to enter, edit, and save the detailed workshop information, such as shop name, address, phone number and other remarks, which, when printing vehicle diagnostics reports and other associated test file, will display as the header of the printed documents.

The screenshot shows a mobile application interface titled "Workshop information". It is divided into two main sections: "Basic information" and "More information".

Basic information:

- Set shop logo (with a camera icon)
- Set page footer logo (with a camera icon)
- Shop name (text input field)
- State (text input field)
- City (text input field)
- Zip code (text input field)
- Address (text input field)
- Tel (text input field)
- Fax (text input field)
- E-mail (text input field)

More information:

- Manager name (text input field)
- Manager title (text input field)
- Website (text input field)
- Slogan (text input field)

The bottom of the screen shows a standard Android navigation bar with icons for back, home, recent apps, camera, and other functions. The status bar at the very bottom indicates 25% battery and the time 3:34.

Figure 9-4 Sample Workshop Information Screen

➤ **To edit the Workshop Information sheet**

1. Tap the **Data Manager** application on the OTOFIX Job Menu.
2. Tap Workshop Information.
3. Enter required information.
4. Tap **Back** to save the updated workshop information record.

9.3 Customer

The Customer function allows you to create and edit customer information. It helps you to save and organize all customer information that is correlated with the associated vehicle history records.

➤ **To create customer information**

1. Tap the **Data Manager** application on the OTOFIX Job Menu.
2. Tap **Customer**.
3. Tap the **Add a customer** button. An empty information form displays, enter required information.

 **NOTE**

The items that must be filled are indicated as required fields.

4. Some customers may have more than one vehicle for service; you can always add new vehicle information to the account. Tap **Add new vehicle information**, and then enter the vehicle information. Tap the  button to delete the information.
5. Tap **Complete** to save the account, or tap **Cancel** to exit without saving.

➤ **To edit customer information**

1. Tap **Data Manager** on the OTOFIX Job Menu.
2. Tap **Customer**.
3. Select the customer information by tapping the corresponding name card. A Customer Information record displays.
4. Tap **Edit** on the top toolbar to start editing.
5. Edit or amend information and enter updated information.
6. Tap **Complete** to save the updated information, or tap **Cancel** to exit without saving.

➤ **To delete customer information**

1. Tap **Data Manager** on the OTOFIX Job Menu.
2. Tap **Customer**.
3. Select the customer information by tapping the corresponding name card. A Customer Information record displays.
4. Tap **Edit** on the top toolbar to start editing.
5. Tap **Delete** on the top of the screen. A reminder message displays.
6. Tap **OK** to confirm the command, and the account is deleted. Tap **Cancel** to cancel the request.

9.4 Image

The Image section is a PNG database containing all captured screenshots.

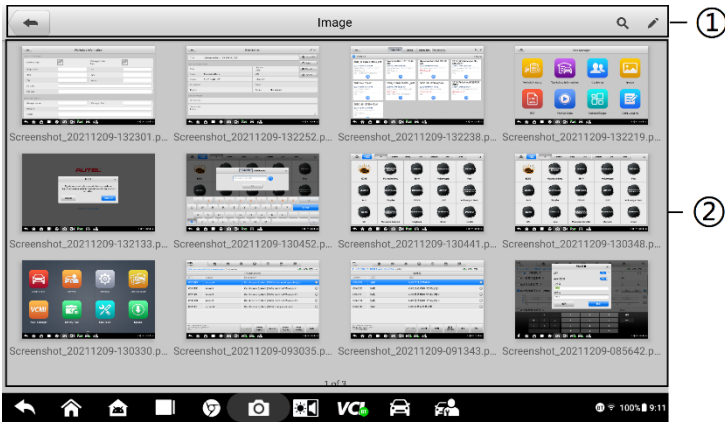

Figure 9-5 Sample Image Database Screen

- ① **Toolbar Buttons** — used to edit, print and delete stored image files. See [Table 9-2 Toolbar Buttons in PNG Database](#) on page 75 for detailed information.
- ② **Main Section** — displays the stored images.

Table 9-2 Toolbar Buttons in PNG Database

Button	Name	Description
	Back	Returns to the previous screen.
	Search	Displays the Search column, allows you to quickly searches the image by entering the time of the screenshot
	Edit	Displays the editing toolbar to select, delete, print, or email the image(s).
	Cancel	Closes the editing toolbar or cancels file search.
	Print	Prints the selected image.
	Delete	Deletes the selected image.
	E-mail	Sends the selected image to an email.

➤ **To edit/delete image(s)**

1. Tap **Data Manager** from the OTOFIX Job Menu.
2. Tap **Image** to access the PNG database.
3. Tap **Edit** on the top-right corner of the screen. The editing screen displays.
4. Select the image(s) you want to edit.
5. Tap **Delete** to delete the selected images or delete all images. Tap **Print** to select to print the selected image(s) or send the selected image(s) to an email.

9.5 Report

The Report section stores diagnostics information of the vehicle and forms a diagnostics report for user to upload.

9.6 PDF

The PDF section stores and displays all PDF files of saved data. After entering the PDF database, select a PDF file to view the stored information.

This section uses the standard Adobe Reader application for file viewing and editing. Please refer to the associated Adobe Reader manual for more detailed instructions.

9.7 Review Data

The Review Data section allows you to playback the recorded data frames of live data streams. On the Review Data main screen, you can select a record file to playback. Use the Navigation Toolbar buttons to playback the record data from frame to frame.

9.8 Uninstall Apps

This section allows you to manage the firmware applications installed on the OTOFIX Diagnostics System. Selecting this section opens a managing screen, on which you can check all the available vehicle diagnostics applications.

9.9 Data Logging

The Data Logging section allows you to launch Support platform directly to view all records of all feedback or not feedback (saved) data loggings on the diagnostics system. For more details, see [Data Logging](#) on page 84.

10 VCI Manager

This application allows you to pair up the tablet with the VCI device, check the communication status, and update the VCI and BAS firmware.

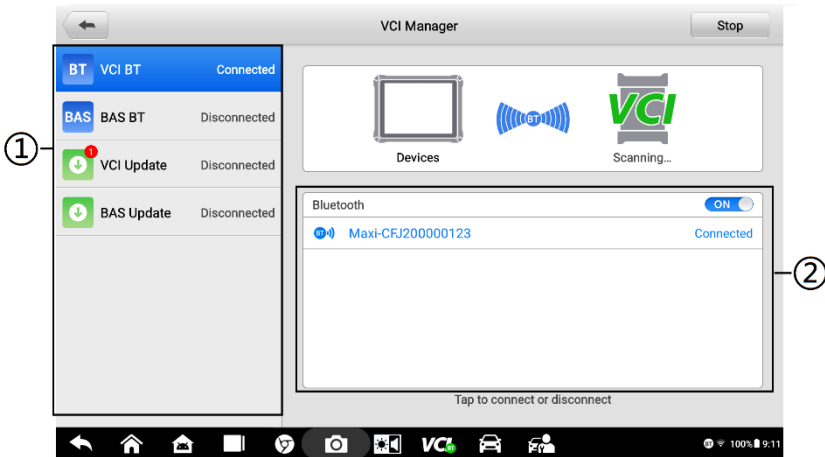

Figure 10-1 Sample VCI Manager Screen

① Connection mode — there are four connection modes available for selection. The connection state is displayed alongside.

- **VCI BT** — when paired to a VCI via Bluetooth, the connection state displays as Connected; otherwise it displays as Disconnected.

➤ **To pair the VCI with the tablet via Bluetooth**

1. Power on the tablet.
2. Connect the OTOFIX Diagnostics Platform to the vehicle through the V1. See [Establishing Vehicle Communication](#) on page 16.
3. Tap **VCI Manager** on the OTOFIX Job Menu of the tablet.
4. Tap **VCI BT** from the connection mode list.
5. Toggle Bluetooth **ON**. The device will start searching for available units for pairing.
6. Depending on the VCI you use, the device name may appear as "Maxi" suffixed with the serial number. Select the appropriate device for pairing.
7. When paired successfully, the connection status reads as Connected.
8. After a few seconds, the VCI button on the system Navigation Bar at the bottom of the screen will display a green badge, indicating that the tablet is

connected to the VCI.

9. To disconnect the device, tap the connected device again.
10. Tap **Back** icon on the top-left to return to the OTOFIX Job Menu.

① **NOTE**

A VCI can be paired with only one tablet at a time, and once it's been paired, the device will not be discovered by any other unit.

- **BAS BT** — when paired to a battery tester via Bluetooth, the connection state displays as Connected; otherwise it displays as Disconnected. For details, see [Establishing Communication](#) on page 53.

- **VCI Update** — updates VCI firmware via the Internet through the OTOFIX tablet networking using USB connection.

➤ **To update the VCI**

1. Power on the tablet.
2. Connect the VCI to the tablet via Bluetooth or USB.
3. Tap **VCI Manager** on the OTOFIX Job Menu of the tablet.
4. Tap **VCI Update** from the connection mode list.
5. The current version and the latest version of the VCI will appear. Tap **Update now** to update the VCI.

- **BAS Update** — updates BAS firmware via the Internet through the OTOFIX tablet networking using USB connection.

➤ **To update the BT1 Lite**

1. Power on the tablet and the BT1 Lite.
2. Connect the BT1 Lite device to the tablet via Bluetooth or USB.
3. Tap **VCI Manager** on the OTOFIX Job Menu of the tablet.
4. Tap **BAS Update** from the connection mode list.
5. The current version and the latest version of the BT1 Lite will appear. Tap **Update now** to update the BT1 Lite.

- ② **Bluetooth settings** — displays the type and a partial serial number for all of the devices available for pairing. Tap the desired device to start pairing. The Bluetooth status icon displayed to the left of the device name indicates the received signal strength.

11 Remote Desktop

The Remote Desktop application launches the TeamViewer QuickSupport program, which is a simple, fast and secure remote control interface. You can use the application to receive ad-hoc remote support from Autel's support technicians by allowing them to control your OTOFIX tablet on their PC via the TeamViewer software.

11.1 Operations

If you think of a TeamViewer connection as a phone call, the TeamViewer ID would be the phone number under which all TeamViewer Clients can be reached separately. PCs and mobile devices that run TeamViewer are identified by a globally unique ID. The first time the Remote Desktop application is launched, this ID is generated automatically based on the hardware characteristics and will not change later on.

NOTE

Make sure the tablet is connected to the Internet before launching the Remote Desktop application, so that the tablet is accessible to receive remote support from the third party.

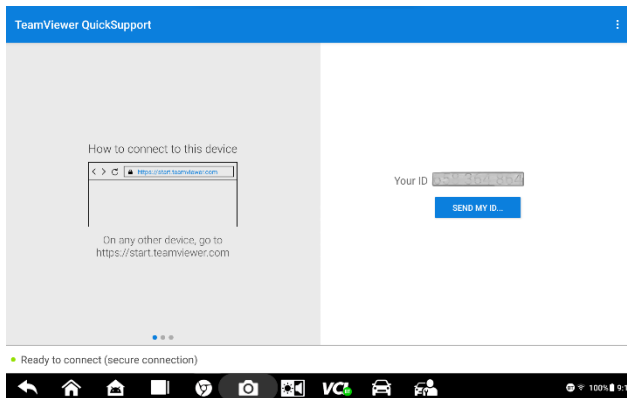

Figure 11-1 Sample Remote Desktop Screen

To receive remote support from a technician

1. Power on the tablet.
2. Tap the **Remote Desktop** application on the OTOFIX Job Menu. The **TeamViewer QuickSupport** screen displays and the device ID is generated and shown.
3. The technician must install the Remote Control software to their PC by downloading the TeamViewer full version program online (see <http://www.teamviewer.com>), and then launch the software.

4. Provide your device ID to the technician, and wait for the technician to send you a remote control request.
5. A pop-up dialog box displays to ask for your confirmation to allow remote control on your device.
6. Tap **Allow** to accept or tap **Deny** to reject.

Refer to the associated TeamViewer documents for additional information.

12 User Feedback

The User Feedback application allows you to submit questions related to this product.

➤ **To send new user feedback**

1. Tap **User Feedback** on the OTOFIX Job Menu. The device information is automatically synchronized.

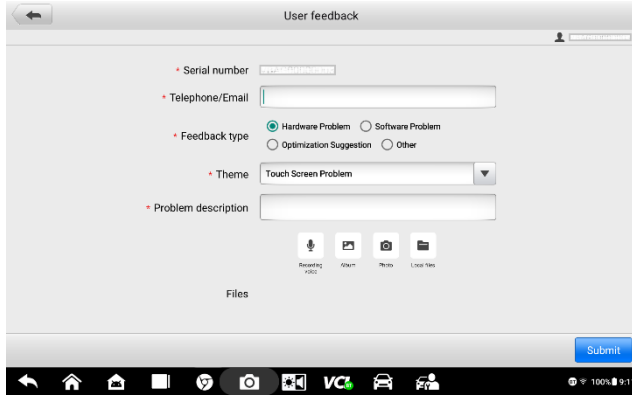

Figure 12-1 Sample User Feedback Screen

2. Set **Telephone/Email**, **Feedback type**, **Theme**, and **Problem description**. You can also attach voice recordings, photos, screenshots, images or PDF files to the form. To help us resolve the issue more efficiently, we recommend you complete the form with as detailed as possible.
3. Tap **Submit** to send the completed form to Autel's online service center. The submitted feedback will be carefully read and handled by our service personnel.

13 Quick Link

The Quick Link application provides you with convenient access to OTOFIX official website and many other well-known sites in automotive service, which offers you abundant information and resources, such as technical help, knowledge base, forums, training, and expertise consultations.

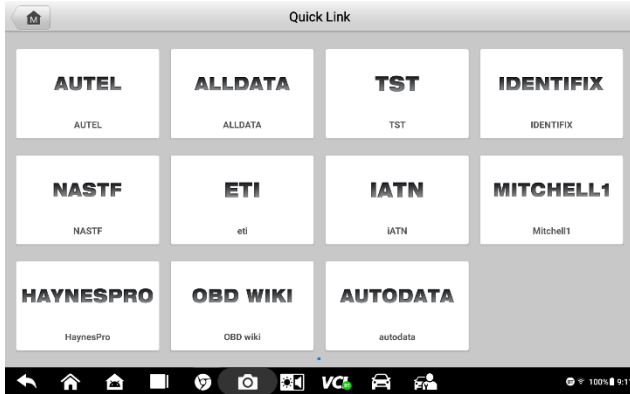

Figure 13-1 Sample Quick Link Screen

➤ **To access a quick link**

1. Tap **Quick Link** on the OTOFIX Job Menu. The Quick Link screen appears.
2. Select a website thumbnail from the main section. The browser is launched and the selected website is opened. Now you can start exploring the website.

14 Support

This application launches the Support platform which synchronizes Autel's on-line service base station with the tablet. In order to synchronize the device to your on-line account, you need to register the product through the Internet when you use it for the first time. The Support application is connected to Autel's service channel and on-line communities which provides the quickest way for problem solutions, allowing you to submit complaints or sent help requests to obtain direct services and supports.

14.1 My Account

The My Account screen displays the comprehensive information of the user and the product, which is synchronized with the on-line registered account, including Personal Info, Update Info and Service Info.

14.1.1 Personal Info

The User information and Device information columns are both included on the Personal Info tab.

- **User information** — displays detailed information of your registered on-line Autel account, such as your Autel ID, Real name, Country/District, Town/City, Company/Institute, Address and Post code.
- **Device information** — displays the registered product information, including the Product serial number, Registration time, Expired time, and Warranty period.

14.1.2 Update Info

The Update Info tab displays a detailed record list of the product's software update history, including the product serial number, software version or name, and the update time.

14.1.3 Service Info

The Service Info tab displays a detailed record list of the device's service history information. Every time the device has been sent back to Autel for repair, the device's serial number and the detailed repair information, including Service date, Type of faults, and Repair content, will be recorded and updated to the associated online product account, which will be synchronized to the Service Info tab.

14.2 Training

The Training screen provides quick links to Autel's online video accounts. Select a video channel by the language to see all the available online tutorial videos from Autel for

various technical supports, such as product usage techniques and vehicle diagnostics practice, etc., may be available for your interests.

14.3 Data Logging

The Data Logging screen keeps records of all Feedback, No feedback and Test Histories data loggings on the diagnostics system. The support personnel receive and process the submitted reports through the Support platform, and send back problem solutions to the corresponding Data Logging session, on which you are also allowed to have a direct conversation with the support personnel.



Figure 14-1 Sample Data Logging Screen

14.4 FAQ

The FAQ tab provides you comprehensive and abundant references for all kinds of questions frequently asked and answered about the use of Autel's online member account, and shopping and payment procedures.

- **Account** — displays questions and answers about the use of Autel's online user account.
- **Shopping** — displays questions and answers about online product purchase methods or procedures.
- **Payment** — displays questions and answers about online payment methods or procedures.

15 OEM Authorization

The OEM Authorization application allows to unlock the gateway ECU (CGW) for some vehicles to perform advanced diagnostics tests.

NOTE

Make sure the tablet is connected to the Internet before launching the OEM Authorization application.

➤ To unlock the gateway ECU (CGW)

1. Connect the OTOFIX Diagnostics Platform to the vehicle through the V1. See [Establishing Vehicle Communication](#) on page 16.
2. Tap **Diagnostics** on the OTOFIX Job Menu.
3. Tap **Renault**, select the vehicle type and tap **OK** to confirm the vehicle information.
4. On the Information screen, tap **Unlock**.

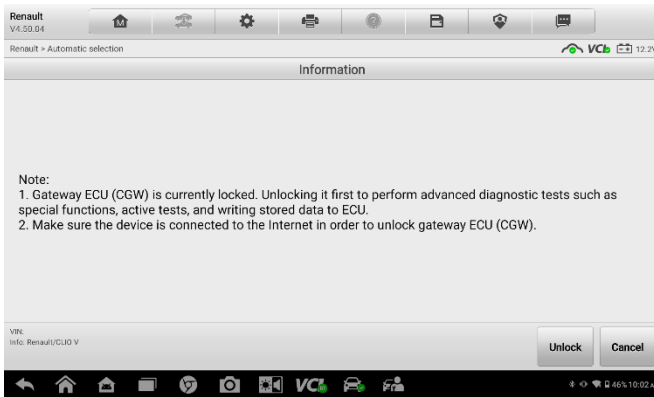

Figure 15-1 Sample Information Screen

5. On the Purchase screen, tap **OK**. Select purchase method and pay to unlock the gateway. On the Purchase Successful screen, tap **OK**.

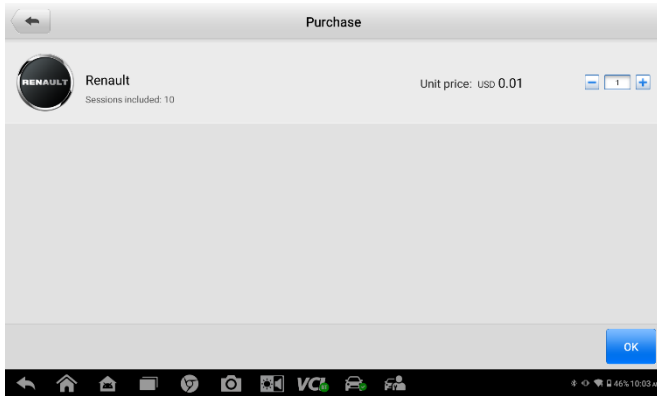

Figure 15-2 Sample Purchase Screen

6. Exit the Diagnostics application. Tap **OEM Authorization** on the OTOFIX Job Menu. On the OEM Authorization screen, tap **Renew**. The Unlocking Information screen appears, on which you can view the remaining service sessions.



Figure 15-3 Sample Unlocking Information Screen

16 MaxiViewer

The MaxiViewer application allows you to search the functions supported by our tools and the version information. There are two ways of searching, either by searching the product and the vehicle or searching the functions.

➤ **To search by product and vehicle**

1. Tap **MaxiViewer** on the OTOFIX Job Menu. The Function Viewer screen displays.
2. Select a product from the Product type drop-down list.

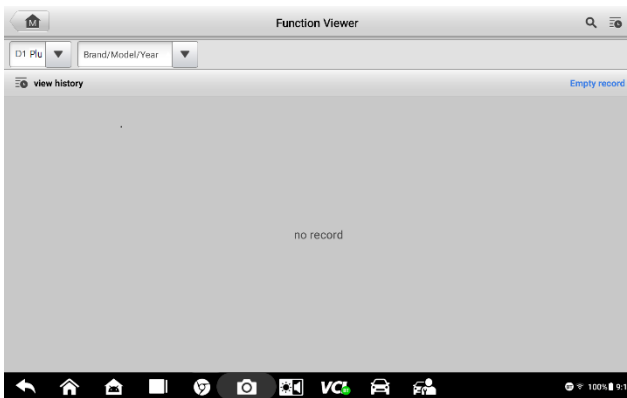

Figure 16-1 Sample Function Viewer Screen 1

3. Select vehicle brand, model, and year.
4. All functions supported by the selected product for the desired vehicle are displayed with vehicle's system, type, function, sub function, and version.

➤ **To search by functions**

1. Tap **MaxiViewer** on the OTOFIX Job Menu. The Function Viewer screen appears.
2. Select a product from the Product type drop-down list.
3. Tap the **Search** icon. Enter the desired function in the search box. The screen will display all vehicles that support this function, along with information such as the vehicles' year, system, capacity, type, function, sub-function, and version.

Function Viewer

D1 PIU Brand/Model/Year System Engine Type

Year	System	Engine	Type	Function	Sub-function	Version
2016 (G)	(ADAS) 3C - Lane Change Assistant	/	/	Active test	/	Above Audi_V16.00
2016 (G)	(ADAS) 3C - Lane Change Assistant	/	/	Adaptation	/	Above Audi_V16.00
2016 (G)	(ADAS) 3C - Lane Change Assistant	/	/	Advanced ID	/	Above Audi_V16.00
2016 (G)	(ADAS) 3C - Lane Change Assistant	/	/	Basic setting	/	Above Audi_V16.00
2016 (G)	(ADAS) 3C - Lane Change Assistant	/	/	Coding	/	Above Audi_V16.00
2016 (G)	(ADAS) 3C - Lane Change Assistant	/	/	ECU information	/	Above Audi_V16.00
2016 (G)	(ADAS) 3C - Lane Change Assistant	/	/	Erase codes	/	Above Audi_V16.00

VC

Figure 16-2 Sample Function Viewer Screen 2

17 Maintenance and Service

To ensure that the OTOFIX Diagnostics tablet and the combined VCI unit perform at their optimum level, we advise that the product maintenance instructions covered in this section is read and followed.

17.1 Maintenance Instructions

The following shows how to maintain your devices, together with precautions to take.

- Use a soft cloth and alcohol or a mild window cleaner to clean the touch screen of the tablet.
- Do not use any abrasive cleansers, detergent, or automotive chemicals to the tablet.
- Maintain the devices in dry conditions and keep them within normal operating temperatures.
- Dry your hands before using the tablet. The touch screen of the tablet may not work if the touch screen is moist, or if you tap the touch screen with wet hands.
- Do not store the devices in humid, dusty or dirty areas.
- Check the housing, wiring, and connectors for dirt and damage before and after each use.
- At the end of each work day, wipe the device housing, wiring, and connectors clean with a damp cloth.
- Do not attempt to disassemble your tablet or the VCI unit.
- Do not drop or cause severe impact to the devices.
- Use only authorized battery chargers and accessories. Any malfunction or damage caused by the use of unauthorized battery charger and accessories will void the limited product warranty.
- Ensure that the battery charger does not come in contact with conductive objects.
- Do not use the tablet beside microwave ovens, cordless phones and some medical or scientific instruments to prevent signal interference.

17.2 Troubleshooting Checklist

- A. When the tablet does not work properly:
- Make sure the tablet has been registered online.
 - Make sure the system software and diagnostics application software are properly updated.
 - Make sure the tablet is connected to the Internet.
 - Check all cables, connections, and indicators to see if the signal is being received.
- B. When battery life is shorter than usual:
- This may happen when you are in an area with low signal strength. Turn off your device if is not in use.
- C. When you cannot turn on the tablet:
- Make sure the tablet is connected to a power source or the battery is charged.
- D. When you are unable to charge the tablet:
- Your charger maybe out of order. Contact your nearest dealer.
 - You may be attempting to use the device in an overly hot/cold temperature. Try changing the charging environment.
 - Your device may have not been connected to the charger properly. Check the connector.

NOTE

If your problems persist, please contact Autel's technical support personnel or your local selling agent.

17.3 About Battery Usage

Your tablet is powered by a built-in lithium-ion polymer battery. This means that, unlike other forms of battery technology, you can recharge your battery while some charge remains without reducing your tablet's autonomy due to the "battery memory effect" inherent in those technologies.

DANGER

- The built-in lithium-ion polymer battery is factory replaceable only; incorrect replacement or tampering with the battery pack may cause an explosion.
 - Do not use a damaged battery charger.
 - Do not disassemble or open crush, bend or deform, puncture or shred.
 - Do not modify or remanufacture, attempt to insert foreign objects into the battery, expose to fire, explosion or other hazard.
 - Make sure to use the charger and USB cables only that come together in the package. If you use the other charger and USB cables, you might incur malfunction or failure of the device.
 - Only use the charging device that has been qualified with device per the standard. Use of an unqualified battery or charger may present a risk of fire, explosion, leakage, or other hazard.
 - Avoid dropping the tablet. If the tablet is dropped, especially on a hard surface, and the user suspects damage, take it to a service center for inspection.
 - The closer you are to your network's base station, the longer your tablet usage time because less battery power is consumed for the connection.
 - The battery recharging time varies depending on the remaining battery capacity.
 - Battery life inevitably shortens over time.
 - Since over charging may shorten battery life, remove the tablet from its charger once it is fully charged. Unplug the charger, once charging is complete.
 - Leaving the tablet in hot or cold places, especially inside a car in summer or winter, may reduce the capacity and life of the battery. Always keep the battery within normal temperatures.
-

17.4 Service Procedures

This section provides information on technical support, repair service, and application for replacement or optional parts.

17.4.1 Technical Support

If you have any question or problem on the operation of the product, please contact us.

NORTH AMERICA

- **Phone:** (833) 686-1349 (OTO-1FIX) Monday-Friday 9am-6pm EST
- **Website:** www.otofixtech.com
- **Email:** ussupport@otofixtech.com
- **Address:** 175 Central Avenue, Suite 200, Farmingdale, New York, USA 11735

CHINA HEADQUARTER

- **Phone:** 0086-755-2267-2493
- **Website:** www.otofix.cn
- **Email:** support@otofixtech.com
- **Address:** 7-8th, 10th Floor, Building B1, Zhiyuan, Xueyuan Road, Xili, Nanshan, Shenzhen, 518055, China

EUROPE

- **Phone:** +49 895 40299621 (Monday-Friday, 9:00AM-6:00PM Berlin Time)
- **Email:** support.eu@otofixtech.com
- **Address:** Robert-Bosch-Strasse 25, 63225, Langen, Germany

LATIN AMERICA

- **Email:** latsupport@otofixtech.com
- **Address:** Avenida Americas 1905, 6B, Colonia Aldrete, Guadalajara, Jalisco, Mexico

APAC

- **Phone:** +045 5948465
- **Email:** apacsupport@otofixtech.com
- **Address:** 719, Nissou Building, 3-7-18, Shinyokohama, Kouhoku, Yokohama, Kanagawa, Japan 222-0033

IMEA DMCC

- **Phone:** +971 585 002709
- **Email:** imeasupport@otofixtech.com
- **Address:** Office 1006-1010, Cluster C, Fortune Tower, Jumeirah Lakes Tower (JLT), Dubai, U.A.E

For technical assistance in other markets, please contact your local selling agent.

17.4.2 Repair Service

If it becomes necessary to return your device for repair, please download the repair service form from www.otofixtech.com and fill in the form. The following information must be included:

- Contact name
- Return address
- Telephone number
- Product name
- Complete description of the problem
- Proof-of-purchase for warranty repairs
- Preferred method of payment for non-warranty repairs

NOTE

For non-warranty repairs, payment can be made with Visa, Master Card, or with approved credit terms.

Send the device to your local agent, or to the address below:

7-8th, 10th Floor, Building B1, Zhiyuan, Xueyuan Road, Xili, Nanshan, Shenzhen, 518055, China

17.4.3 Other Services

You can purchase the optional accessories directly from Autel's authorized tool suppliers, and/or your local distributor or agent.

Your purchase order should include the following information:

- Contact information
- Item description
- Product or part name
- Purchase quantity

18 Compliance Information

18.1 FCC Compliance

FCC ID: WQ8-D1PLUS2125

This device complies with Part 15 of the FCC rules and Industry Canada's license-exempt RSSs. Operation is subject to the following two conditions:

1. This device may not cause harmful interference.
2. This device must accept any interference received, including interference that may cause undesired operation.

WARNING

Changes or modifications not expressly approved by the party responsible for compliance could void the user's authority to operate the equipment.

NOTE

This equipment has been tested and found to comply with the limits for a Class B digital device, pursuant to Part 15 of the FCC Rules. These limits are designed to provide reasonable protection against harmful interference in a residential installation.

This equipment generates uses and can radiate radio frequency energy and, if not installed and used in accordance with the instructions, may cause harmful interference to radio communications. However, there is no guarantee that interference will not occur in a particular installation. If this equipment does cause harmful interference to radio or television reception, which can be determined by turning the equipment off and on, the user is encouraged to try to correct the interference by one or more of the following measures:

- Reorient or relocate the receiving antenna.
- Increase the separation between the equipment and receiver.
- Connect the equipment into an outlet on a circuit different from that to which the receiver is connected.
- Consult the dealer or an experienced radio/TV technician for help.

Changes or modifications not expressly approved by the party responsible for compliance could void the user's authority to operate the equipment.

18.2 RF Warning Statement

The device has been evaluated to meet general RF exposure requirement. The device can be used in portable exposure condition without restriction.

18.3 RoHS Compliance

This device is declared to be in compliance with the European RoHS Directive 2011/65/EU.

18.4 CE Compliance

RED Directive 2014/53/EU

18.5 IC Compliance

IC ID: 10826A-D1PLUS2125

19 Warranty

12-month Limited Warranty

Autel Intelligent Technology Corp., Ltd. (the Company) warrants to the original retail purchaser of this Diagnostics tablet that should this product or any part thereof during normal usage and under normal conditions be proven defective in material or workmanship that results in product failure within twelve (12) months period from the date of purchase, such defect(s) will be repaired, or replaced (with new or rebuilt parts) with Proof of Purchase, at the Company's option, without charge for parts or labor directly related to the defect(s).

The Company shall not be liable for any incidental or consequential damages arising from the use, misuse, or mounting of the device. Some states do not allow limitation on how long an implied warranty lasts, so the above limitations may not apply to you.

This warranty does not apply to:

- a) Products subjected to abnormal use or conditions, accident, mishandling, neglect, unauthorized alteration, misuse, improper installation or repair or improper storage;
- b) Products whose mechanical serial number or electronic serial number has been removed, altered or defaced;
- c) Damage from exposure to excessive temperatures or extreme environmental conditions;
- d) Damage resulting from connection to, or use of any accessory or other product not approved or authorized by the Company;
- e) Defects in appearance, cosmetic, decorative or structural items such as framing and non-operative parts.
- f) Products damaged from external causes such as fire, dirt, sand, battery leakage, blown fuse, theft or improper usage of any electrical source.

! IMPORTANT

All contents of the product may be deleted during the process of repair. You should create a back-up copy of any contents of your product before delivering the product for warranty service.
