





WARNING SYMBOLS AND DEFINITIONS

	This safety alert symbol is used to alert you to potential injury hazards. Obey all safety messages that follow this symbol to avoid possible injury.
 DANGER	Indicates an imminently hazardous situation which, if not avoided, could result in death or serious injury to the operator or to bystanders.
 WARNING	Indicates a potentially hazardous situation which, if not avoided, could result in death or serious injury to the operator or to bystanders.
 CAUTION	Indicates a hazardous situation which, if not avoided, could result in minor or moderate injury to the operator or to bystanders.
NOTE	Addresses practices not related to personal injury.

IMPORTANT SAFETY INFORMATION

 **DANGER**

When an engine is operating, keep the service area well-ventilated or attach a building exhaust removal system to the engine exhaust system. Engines produce various poisonous compounds (hydrocarbon, carbon monoxide, nitrogen oxides, etc.) that cause slower reaction time and result in death or serious personal injury.

 **WARNING****Read all safety warnings and instructions.**

*Note: Failure to follow the warnings and instructions may result in electric shock, fire and/or serious injury.

1. Always perform automotive testing in a safe environment.
2. Do not connect or disconnect any test equipment while the ignition is on or the engine is running.
3. **DO NOT attempt to operate the tool while driving the vehicle. Have second personal operate the tool. Any distraction may cause an accident.**
4. Before starting the engine, put the gear lever in the Neutral position (for manual transmission) or in the Park (for automatic transmission) position to avoid injury.
5. NEVER smoke or allow a spark or flame in vicinity of battery or engine. Do not operate the tool in explosive atmospheres, such as in the presence of flammable liquids, gases, or heavy dust.
6. Keep a fire extinguisher suitable for gasoline/chemical/electrical fires nearby.
7. Wear an ANSI-approved eye shield when testing or repairing vehicles.
8. Put blocks in front of the drive wheels and never leave the vehicle unattended while testing.
9. Use extreme caution when working around the ignition coil, distributor cap, ignition wires and spark plugs. These components create hazardous voltage when the engine is running.
10. To avoid damaging the tool or generating false data, please make sure the vehicle battery is fully charged and the connection to the vehicle DLC (Data Link Connector) is clear and secure.

11. Automotive batteries contain sulfuric acid that is harmful to skin. In operation, direct contact with the automotive batteries should be avoided. Keep the ignition sources away from the battery at all times.
12. Keep the tool dry, clean, free from oil, water or grease. Use a mild detergent on a clean cloth to clear the outside of the equipment when necessary.
13. Keep clothing, hair, hands, tools, test equipment, etc. away from all moving or hot engine parts.
14. Store the tool and accessories in a locked area out of the reach of children.
15. Do not use the tool while standing in water.
16. Do not expose the tool or power adaptor to rain or wet conditions. Water entering the tool or power adaptor increases the risk of electric shock.

Table of Contents

1 Introduction.....	1
1.1 Product Profile	1
1.2 Features	1
1.3 Technical Specifications	2
2 Components & Controls	3
2.1 Display Tablet	4
2.2 Docking Station (Optional).....	5
2.3 VCI Device.....	6
2.4 Accessory Checklist.....	7
3 Preparations.....	9
3.1 Charging the Tablet	9
3.2 Power ON/OFF	9
3.3 Locator & Navigation Buttons	10
3.4 Wi-Fi Setup.....	10
4 Initial Use.....	11
4.1 Getting Started	11
4.2 Register & Download Diagnostic Software.....	11
4.3 Function Modules	13
4.4 Vehicle Menu Layout	14
4.5 Diagnostics toolbar	14
5 Start Diagnostics	16
5.1 Connections.....	16
5.1.1 Preparation	16

5.1.2 DLC Location.....	16	5.5.2 Add Friends	35
5.1.3 Vehicle Connection (For Passenger Vehicle Version)	16	5.5.3 Start Instant Messaging.....	36
5.1.3 Vehicle Connection (For Commercial Vehicle Version/Diesel & Gasoline Version).....	17	5.5.4 Launch Remote Diagnosis (Device-To-Device).....	37
5.2 Communication Setup	18	5.5.5 Launch Remote Diagnosis (Device-To-PC).....	38
5.3 Start Diagnostics	18	5.6 Diagnostic History.....	40
5.3.1 Intelligent Diagnosis	18	5.7 Software Update.....	40
5.3.2 Local Diagnosis	20	5.7.1 Update Diagnostic Software & APP.....	40
5.4 Maintenance Reset.....	31	5.7.2 Set Frequently Used software	41
5.4.1 Oil Reset Service.....	31	5.8 Store	41
5.4.2 Electronic Parking Brake Reset.....	32	5.9 ADAS	42
5.4.3 Steering Angle Calibration	32	5.10 Feedback.....	43
5.4.4 ABS Bleeding.....	32	6 User Info.....	44
5.4.5 Tire Pressure Monitor System Reset.....	32	6.1 My Report.....	44
5.4.6 Gear Learning.....	32	6.2 VCI.....	45
5.4.7 IMMO Service.....	33	6.3 Immobilizer Programmer	45
5.4.8 Injector Coding	33	6.4 Activate VCI	46
5.4.9 Battery Maintenance System Reset.....	33	6.5 Fix connector firmware/system.....	46
5.4.10 Diesel Particulate Filter (DPF) Regeneration	33	6.6 My News.....	46
5.4.11 Electronic Throttle Position Reset	34	6.7 Data Stream Sample	46
5.4.12 Gearbox Matching	34	6.8 Vehicle Voltage.....	46
5.4.13 AFS (Adaptive Front-lighting System) Reset	34	6.9 My Order.....	46
5.4.14 Sunroof Initialization	34	6.10 Subscription Renewal Card.....	46
5.4.15 Suspension Calibration	34	6.11 Profile.....	46
5.5 Remote Diagnosis	35	6.12 Change Password	47
5.5.1 Interface Layout.....	35	6.13 Settings.....	47
		6.13.1 Units	47

6.13.2 Shop Information	47	7.3.1 Introduction	72
6.13.3 Printer Set	47	7.3.2 Structure & Accessories	72
6.13.4 Clear Cache	48	7.3.3 Connection & Initial Use	75
6.13.5 About	48	7.3.4 Operations	79
6.13.6 Diagnostic Software Auto Update	48	7.4 Ignition (Optional)	85
6.13.7 Login/Exit from current account	48	7.4.1 Secondary-distributor ignition analysis	85
6.14 Diagnostic Software Clear	48	7.4.2 Secondary-simultaneous ignition analysis	87
7 ToolBox	49	7.4.3 Secondary-direct ignition analysis	88
7.1 Sensorbox & Multimeter (Optional)	49	7.4.4 Waveform analysis mode	89
7.1.1 Product summary	49	7.5 Videoscope (Optional)	92
7.1.2 Components and Accessories	50	7.5.1 Introduction	92
7.1.3 Sensor Simulation	51	7.5.2 Components & controls	93
7.1.4 Multimeter	55	7.5.3 Technical Parameters	93
7.2 Battery Tester (V1.0, Optional)	56	7.5.4 Connections & Operations	94
7.2.1 Product Summary	56	8 Other Modules	95
7.2.2 Test Environment	57	8.1 Email	95
7.2.3 Components and Accessories	57	8.2 Browser	95
7.2.4 Connections & Operations	58	8.3 TeamViewer	95
7.2.5 Precautions on battery test	60	8.3.1 TeamViewer QuickSupport	95
7.2 Battery Detection (V2.0, Optional)	62	8.3.2 TeamViewer	96
7.2.1 Product Summary	62	8.4 Wireless Upgrade	96
7.2.2 Battery Health Test	64	8.5 Files	96
7.2.3 Start System Test	67	8.6 Gallery	97
7.2.4 Charging Health Test	68	8.7 Recording Master	97
7.2.5 Reports	70	Appendix - FAQ	98
7.3 Oscilloscope (Optional)	72		

1 Introduction

1.1 Product Profile

X-431 PAD V is an evolutionary smart solution for specialized automotive diagnosis and maintenance. It inherits from LAUNCH's advanced diagnosing technology and is characterized by covering a wide range of vehicles, featuring powerful functions, and providing precise test result.

Through the wireless communication between VCI device and the tablet, it achieves full car model and full system vehicle trouble diagnosis, which include Reading DTCs, Clearing DTCs, Reading Data Stream, Actuation Test and Special Functions.

Moreover, taking advantage of the mobile Internet, it also integrates One-click Update, Remote Diagnosis which helps to diagnose vehicle issues more efficiently, and greatly increase customer's retention and boost shop revenue.

This tool adopts a higher performance-price ratio display tablet, which comes loaded with two Wi-Fi modules, powerful 8-core 2GHZ processor, 4G RAM, and a 10.1" sunlight readable capacitive touch screen with a resolution of 1920 x 1200 pixels.

1.2 Features

1. Diagnose:

- **Smart Diagnosis:** This module allows you to use the VIN information of the currently identified vehicle to access its data (including vehicle information, historical diagnostic records) from the cloud server to perform quick test.
- **Local Diagnosis:** To perform diagnosis by executing on-screen commands step by step. Diagnosis functions include: Read DTCs, Clear DTCs, Read Data Stream, Special Functions etc.

- **Remote Diagnosis:** This option aims to help repair shops or technicians launch instant messaging and remote diagnosis, making the repair job getting fixed faster.
 - **Maintenance & Reset:** All kinds of common maintenance and reset items including Oil lamp reset, DPF regeneration, ABS bleeding can be done.
 - **One-click Update:** Lets you update your diagnostic software online.
 - **Diagnostic History:** Provides a quick access to the tested vehicles and users can choose to view the test report or resume from previous diagnostic session, without the necessity of starting from scratch.
 - **Pre- and Post- Repair Result Comparison:** By comparing the pre-repair and post-repair report, you can clearly determine which vehicle issues have been fixed and which remained unsolved.
 - **Diagnostic Feedback:** Enables you to submit the vehicle issue to us for analysis and troubleshooting.
 - **Toolbox:** Scopebox, Sensorbox, Batterybox and Videoscope (sold separately) are available for extending the functions of the tablet.
 - **Vehicle Coverage:** Quick dial to view the vehicle models that the tablet covers.
2. WLAN connection is supported.
 3. ADAS calibration: Optional. This function needs to be activated before normal use and only works with the LAUNCH-specific ADAS calibration tool.
 4. Web browser: Users can make online search and visit any website.
 5. File Manager: Lets you manage files or downloaded files stored in memory card efficiently.
 6. Settings: To configure your personalized tablet.

1.3 Technical Specifications

A. Display Tablet

Item	Description
Operating system	Android
CPU	8-core processor, 2GHz
Display	10.1 inch capacitive touch screen with 1920 x 1200 resolution
Memory	4GB
Hard disk	64GB
Connectivity	<ul style="list-style-type: none"> • Wi-Fi: 2.4G/5GHz dual frequency • Universal serial BUS Ports (1 x Type-C + 1 x Type-A)
Cameras	8MP front-facing camera + 13MP rear-facing camera
Size	320mm x 211mm x 46mm
Operating Temperature	-10°C ~ 50°C (14 ~ 122°F)
Storage Temperature	-20°C ~ 70°C (-4 ~ 158°F)

B. VCI Device

Item	Description
Working voltage	DC 9V ~ 36V
Memory	256MB
ROM	8GB
USB	Type B x 1
Bluetooth	BT2.1 & 4.2
WiFi	2.4G/5GHz dual frequency

2 Components & Controls

There are three main components to the diagnostic system:

- Display Tablet -- the central processor and monitor for the system (For details, please refer to Chapter 2.1.)



Fig. 2-1

- Docking Station -- the platform for charging the tablet and extending functions (For details, please refer to Chapter 2.2.)



Fig. 2-2

- VCI Device -- the device for accessing vehicle data (For details, please refer to Chapter 2.3.)



Fig. 2-3

2.1 Display Tablet

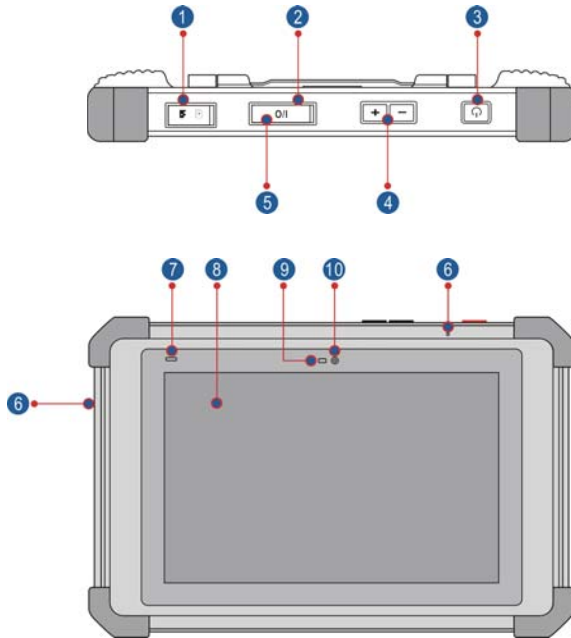

Fig. 2-4 Top & front views

Table 2-1 formulates ports and indicators of display tablet:

No.	Name & Descriptions
1	Memory Card Slot -- To store the memory card for storage expansion.
2	Type C Charging Port -- Reserved for charging the tablet.
3	Power/Screen Lock Button -- To turn the tablet on/off with long press, or lock the screen with short press.
4	Volume Buttons -- To adjust the volume. *Note: Press and hold [POWER] and [VOL -] key to capture the current screenshot.
5	Data I/O Port -- Reserved for add-on modules (such as Batterybox, Scopebox and Sensorbox), and other devices with similar port.
6	Microphone
7	Charging indicator -- It illuminates red while the tablet is charging. Once charging is finished, it will illuminate solid green.
8	10.1" Capacitive Touch Screen
9	Ambient Light Sensor
10	Front Camera

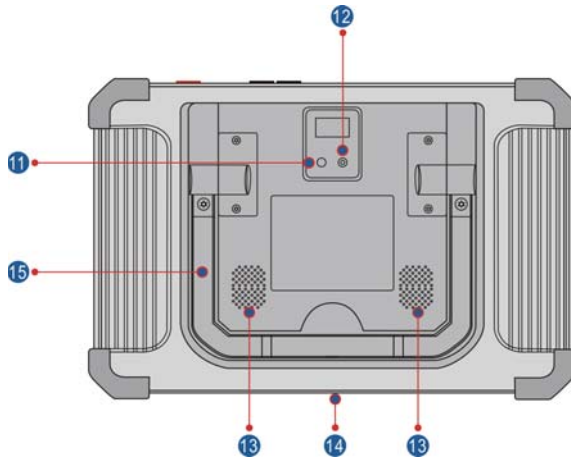

Fig. 2-5 Rear view

Table 2-2 formulates parts of display tablet (rear):

No.	Name & Descriptions
11	Rear Camera
12	Camera Flash
13	Audio Speaker
14	Charging Slot
15	Adjustable Kickstand - Flip out it to any angle and work comfortable at your desk, or hang it on automotive part.

2.2 Docking Station (Optional)



Fig. 2-6 Docking Station

Table 2-3 formulates ports of the docking station

No.	Name & Descriptions
1	Charging Slot -- To charge the tablet.
2	OBD16 Socket -- To store the VCI device to avoid loss.
3	DC 5V OUT Port -- (Reserved for charging other USB devices only.)
4	Type C Charging Port -- Use the power adaptor to supply power to the docking station through connection to AC outlet.
5	Power LED -- Illuminates solid green when it is powered up.

2.3 VCI Device

The VCI device works as a vehicle communication interface device, which is used to connect to the vehicle's DLC (Data Link Connector) socket via OBD II extension cable to read the vehicle data and then send it to the tablet via Wi-Fi or data cable.

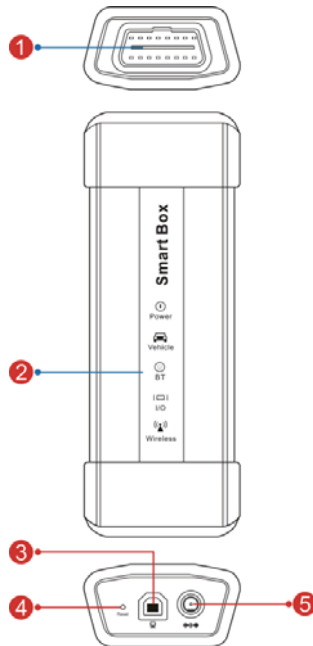

Fig. 2-7 VCI device



Table 2-4 formulates ports and indicators of VCI device:





No.	Name & Descriptions
1	OBD II-16 Diagnostic Connector -- Use the OBD II extension cable to connect VCI device to the vehicle's OBDII DLC.
2	LED Indicators -- It is defined as follows: <ul style="list-style-type: none"> • Power: It illuminates solid red when the module is powered on. • Vehicle: While communicating with the vehicle, the indicator lights up and flashes. Otherwise, it will not illuminate. • BT: It illuminates when the VCI device is working in Bluetooth communication mode. • I/O: It lights up when the VCI device is connected to the tablet via data cable. • Wireless: It illuminates when the VCI device is working in Wi-Fi communication mode.
3	Reset Hole -- To reset the VCI device.
4	Data I/O port -- For connecting the VCI device to the tablet via data cable to perform vehicle diagnosis.
5	DC-IN power jack -- For connecting the power adaptor.



2.4 Accessory Checklist

Common accessories are same, but for different destinations, the accessories (such as diagnostic software, testing connectors) may vary. Please consult from the local agency or check the package list supplied with this tool together.

Table 2-5 -- Common accessories and descriptions

No.	Name	Qt.	Picture
1	Display Tablet	1	
2	VCI Device	1	 (To connect to vehicle's DLC.)
3	Docking Station	1	 (Optional. To charge the tablet.)

4	Cigarette Lighter Cable	1	 (To supply power to non-16pin dangle via vehicle's cigarette lighter receptacle.)
5	Power Adaptor	1	 (To charge the tablet.)
6	Cigarette Lighter Cable	1	 (To provide power to the non-16 pin dangle through connection to the Cigarette Lighter receptacle.)
7	Battery Clamps Cable	1	 (To provide power to the non-16 pin dangle through connection to the vehicle's battery.)

8	OBD II extension cable	1	 (To connect the VCI device for extension purpose.)
9	OBD I Adaptor	1	 (A adaptor cable for connecting non-16 pin dongle.)
10	Password Envelope	1	 (A piece of paper bearing Product S/N and Activation Code, which is required for your registration.)
11	Non-16pin Connector Kit		(Optional)



3 Preparations

3.1 Charging the Tablet



*Notes:

- Only use the included power adaptor to recharge the tablet. Use of any other adaptor will damage the tool. We assume no responsibility for damage or loss resulting from using other similar adaptors other than the specified one.
 - Always charge on a non-flammable surface in a well-ventilated area.
1. To check the battery power level, press and hold the Power button about 3 seconds to turn on the tablet.
 2. Power level is indicated as a percentage in the upper right corner of the screen. If the power level drops below 10% while the tablet is on, a "Connect Charger" notification will appear on the screen.

A. Charging with the Included 5V Power Adaptor

1. Connect one end of the power adaptor to Type C charging port of the tablet, and the other end to the AC outlet.
2. The charging LED illuminates solid red and the charging symbol  will appear on the screen.
3. Once it illuminates solid green, it indicates that the battery is fully charged and the charging complete symbol  replaces the charging symbol. Disconnect the power adaptor from the AC outlet.

B. Charging with the Docking Station

1. Locate the charging slot on the bottom of the tablet and docking station.
2. Align the charging slots, and then dock the tablet into the station to ensure that it is firmly seated on the docking station.
3. Insert one end of the included power cord to the charging port of the docking station, then the other end into the AC outlet. The charging LED illuminates solid red while charging and the charging symbol  will appear on the screen.
4. Once it illuminates solid green, it indicates that the battery is fully charged and the charging complete symbol  replaces the charging symbol. Disconnect the docking station from the AC outlet.

3.2 Power ON/OFF

*Note: If it is the first time you use the tablet or the tablet keeps idle for a long time, it could fail to be turned on. It results from low battery. In this case, please recharge it for a while and try to turn it on.

1. Press and hold the POWER button for about 3 seconds to turn on the tablet. The system starts initializing and then enters the Home screen.
2. To turn the tablet off, press and hold the POWER button until an option menu appears. Tap "Power Off".

3.3 Locator & Navigation Buttons



Fig. 3-1

On-screen keys and status bar are as follows:

- 1 Tap to visit the Launch's official website.
- 2 Tap to capture the current screen and all captured screenshots are stored in the Screenshots folder.
- 3 : Shows whether the VCI device is properly connected or not.
- 4 Tap to display a list of applications that are currently running or recently used. To open an application, tap it. To remove an application, swipe it upwards.
- 5 Tap to navigate to the Android System's home screen.
- 6 Tap to return to the previous screen or exit the application.

3.4 Wi-Fi Setup

The tablet has dual built-in Wi-Fi communication modules. One is used to communicate with the tablet, and the other allows the tablet to get online. Once you're online, you can register your tool, update diagnostic software & APK, browse the Internet, get apps and send email on your network.

If the VCI device is successfully activated, the tablet will automatically connect to the VCI device. In this case it is not necessary for the user to manually configure it again.

*Note: Once WLAN is set as ON, the tablet will consume more power. While it keeps unused, please set it off to save power. While WLAN is not in use, please turn it off to conserve battery power.

Connect to a Wi-Fi Network

1. On the Home screen, tap **Tablet Settings > WLAN**.
2. Move the Wi-Fi switch to ON, the tablet starts searching for available wireless LANs.
3. Select the desired Wi-Fi network from the list. If the chosen network is open, you can connect directly. A password may be required for secured networks.

Disconnect from a Wi-Fi Network

1. On the Home screen, tap **Tablet Settings > WLAN**.
2. Tap the network with a "Connected" status, then tap "Forget".

4 Initial Use

4.1 Getting Started

For new users, please follow the operation chart shown in Fig. 4-1 to get familiar with and start using this tool.

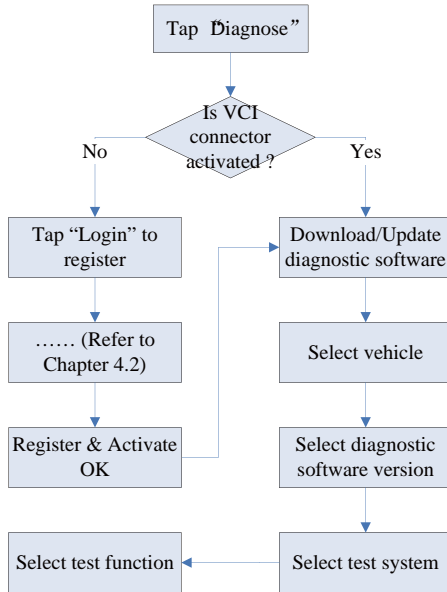

Fig. 4-1

*Note: Before registering, please make sure that the tablet has a strong and stable Wi-Fi signal.

4.2 Register & Download Diagnostic Software

On the home screen, tap the application icon to launch it, and then tap “Login” to enter the login interface of diagnosis software.



Fig. 4-2

(If you are a new user, follow A to proceed.)

(If you have registered to be a member, go to B to login the system directly.)

(In case you forgot password, refer to C to reset a new password.)

A. If you are a new user, tap “New Registration” to enter registration page. See Fig. 4-3.

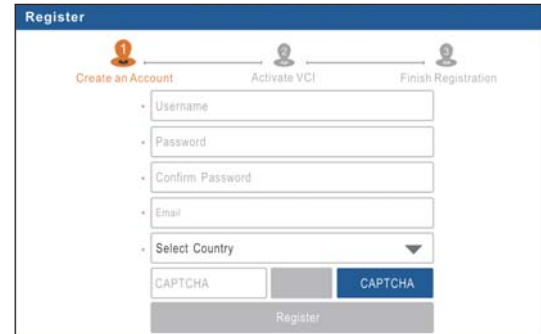

Fig. 4-3

In Fig. 4-3, fill in the information in each field (Items with * must be filled). After inputting, tap “Register”, a screen similar to the following

will appear:



Fig. 4-4

In Fig. 4-4, input the Serial Number and Activation Code, which can be found in the password envelope.



Fig. 4-5

*Note: To exit and activate it later, tap “Skip”. In this case, you can activate your connector by tapping “Activate VCI” under the “User Info” tab.

Tap “Activate” to finish your registration. See Fig. 4-6.

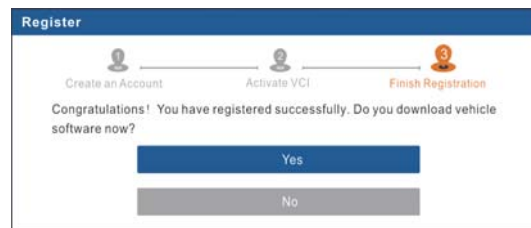

Fig. 4-6

To download the diagnostic software, tap “Yes” to enter the download page. Tap “No” to download and install it later.

On download page, tap “Update” to start downloading. To pause downloading, tap “Stop”. To resume it, tap “Continue”. Once download is complete, the system will install the software package automatically.

*Notes:

- In process of download, please make sure the tablet has a strong Wi-Fi signal. It may take several minutes to finish it, please be patient to wait.
- To use the AutoDetect (VINScan) function, you have to download the corresponding diagnostic software and AutoSearch file.

B. If you have registered to be a member, input your name and password, and then tap the “Login” button to enter the main menu screen directly.

*Note: The tablet has an auto-save function. Once the username and password are correctly entered, the system will automatically store it. Next time you login the system, you will not be asked to input the account manually.

C. If you forgot the password, tap “Retrieve password” and then follow on-screen instructions to set a new password.

4.3 Function Modules

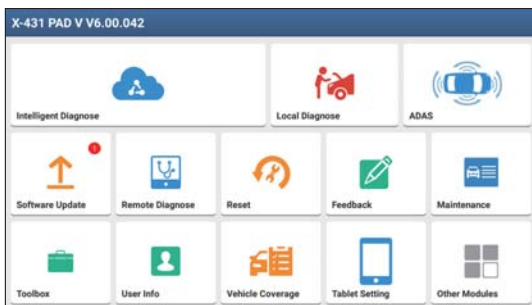

Fig. 4-7

It mainly includes the following items:

Intelligent Diagnose	This module allows you to obtain vehicle data from the cloud server to perform quick test via reading VIN, which provides a perfect solution to various defects resulting from step-by-step menu selection. In addition, user can also check the historical repair records online through this module.
Local Diagnose	To diagnose a vehicle manually.
ADAS	This function enables users to perform ADAS (Advanced Driver Assistance System) calibration operations. The ADAS calibration software is disabled by default. Before using this function, users must activate the ADAS function using the ADAS Activation Card.

Software Update	To update vehicle diagnostic software and APK.
Remote Diagnose	This option aims to help repair shops or technicians launch instant messaging and remote diagnosis, making the repair job getting fixed faster.
Reset	To perform all kinds of common repair & maintenance items, including electronic throttle position reset, ABS bleeding, DPF regeneration, oil lamp reset etc. *Note: This module only applies to Passenger Vehicle /Gasoline & Diesel Version.
Feedback	To feed back the recent 20 diagnostic logs to us for issue analysis.
Maintenance	Abundant maintenance data are available, which helps repair professionals diagnose and repair vehicles efficiently, accurately and profitably.
Toolbox	Includes Camera, Browser, Oscilloscope, Ignition, Sensor, Multimeter, Battery etc.
User Info	To manage VCI, diagnostic reports & records, change password, configure Wi-Fi printer, sample data and logout / login etc.
Vehicle Coverage	To check the vehicle models supported on the tablet.
Tablet Setting	Configures the system setting of the tablet.

Other Modules	Includes TeamViewer, Email, Browser, Wireless Upgrade and FAQ etc.
----------------------	--

4.4 Vehicle Menu Layout

After downloading the diagnostic software, you can go to “Local Diagnose” to check if all software are completely downloaded and installed.

Tap “Local Diagnosis”, a screen similar to the following figure appears:

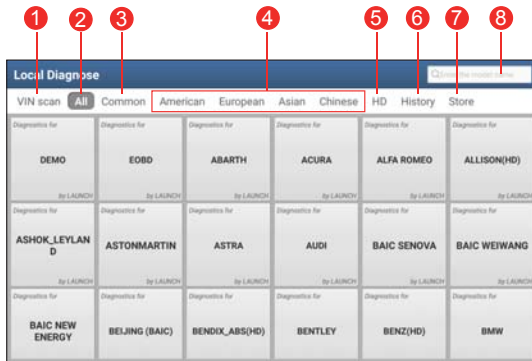





Fig. 4-8

1	VINScan button: Tap it to scan the Vehicle Identification Number (VIN) code of your vehicle. OBD VIN and INPUT VIN are included. This function does not apply to the commercial vehicles. *Note: Before using this function, the corresponding diagnostic software and Auto search file need to be downloaded on your tool first while downloading the diagnostic software.
2	All Tab: Displays all the vehicle makes in the vehicle menu.
3	Common Tab: Displays all frequently-used vehicle makes.
4	Regional buttons: Tap different buttons to switch to corresponding vehicles.
5	HD: If you have purchased a Gasoline & Diesel Version and activated it, this tab will appear.
6	History Button: Generally once a vehicle diagnosis is performed, the tablet will record the every details of diagnostic process. This function provides a quick access to the previously tested vehicles. Testing can be resumed from the previous operation without starting from scratch.
7	Store: Allows you to renew the subscription of diagnostic software and check the order status.
8	Search bar: Input the desired vehicle model to quickly locate it.

4.5 Diagnostics toolbar

The diagnostics toolbar contains a number of buttons that allow you to print the displayed data or make other controls. It is displayed on

the upper right corner of the screen and goes through the whole diagnostic session. The table below provides a brief description for the operations of the diagnostics toolbar buttons:

 Home	Tap to navigate to the home screen.
 Print	Tap to print the current screen. To perform printing, you need to purchase an extra Wi-Fi printer separately.
 Exit Session	Tap to exit the current diagnostic session.

5 Start Diagnostics

5.1 Connections

5.1.1 Preparation

Normal testing conditions

- Turn on the vehicle power supply.
- Vehicle battery voltage range should be 9-18V or 11-36V and working voltage of the tablet is 5V.
- Throttle should be closed at its close position.
- Ignition timing and idle speed should be within specified range; water and transmission oil temperature are within normal working range (water temperature is 90-110°C and transmission oil temperature is 50-80°C).

Select testing connectors/adaptor cables

If the tablet is testing vehicles equipped with universal OBD II 16 PIN diagnostic socket, please use the included VCI device. (For vehicles with non-OBD II 16 PIN diagnostic socket, a non-16 PIN dongle is required.)

5.1.2 DLC Location

For Passenger Vehicles, the DLC (Data Link Connector or Diagnostic Link Connector) is the standardized 16-cavity connector where diagnostic code readers interface with the vehicle's on-board computer. The DLC is usually located 12 inches from the center of the instrument panel (dash), under or around the driver's side for most vehicles. If Data Link Connector is not located under dashboard, a label should be there telling location. For some Asian and European vehicles, the DLC is located behind the ashtray and the ashtray must be removed to access the connector. If the DLC cannot be found, refer

to the vehicle's service manual for the location.

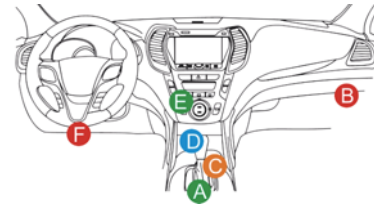

Fig. 5-1

For Commercial Vehicles, the DLC is located in the driver's cab.

5.1.3 Vehicle Connection (For Passenger Vehicle Version)

The method used to connect the VCI device to a vehicle's DLC depends on the vehicle's configuration as follows:

- A vehicle equipped with an OBD II management system supplies both communication and 12V power through a standardized DLC.
- A vehicle not equipped with an OBD II management system supplies communication through a DLC connection, and in some cases supplies 12V power through the cigarette lighter receptacle or a connection to the vehicle battery.

Follow the steps mentioned below to connect OBD II vehicle:

1. Locate vehicle's DLC socket.
2. Use the OBD II extension cable to connect the VCI device to the vehicle's DLC socket.
3. Choose one of the two ways to obtain power from:
 - A. Power adaptor: Connect one end of the included power adaptor to Power interface of the tablet, and the other end to AC outlet.
 - B. Internal battery pack: For details on how to recharge the tablet, see "**Chapter 3.1 Charging the tablet**".

For non-OBDII vehicle, proceed as follows:

1. Locate vehicle's DLC socket.
2. Select the corresponding non-16pin dongle.
3. Plug the non-16pin end of the non-16pin adaptor into the DLC socket, then connect the other end to the OBD I adaptor, and then tighten the captive screws.
4. Connect the other end of the adaptor to the included VCI device.
5. To supply power to OBD I adaptor from:

A. Cigaretter Lighter: Connect one end of the cigarette lighter cable to vehicle's cigarette lighter receptacle, and the other end to the DC-IN jack of the VCI device.

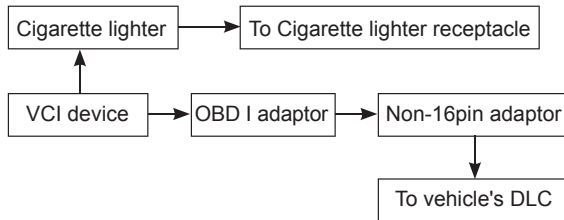

Fig. 5-2

B. Battery Clamps Cable: Connect one end of the battery clamps cable to vehicle's battery, and the other end to the power jack of OBDI adaptor.

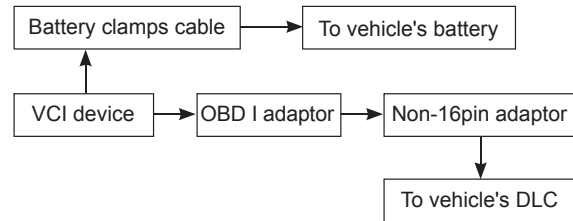

Fig. 5-3

5.1.3 Vehicle Connection (For Commercial Vehicle Version/ Diesel & Gasoline Version)

The method used to connect the VCI device to a vehicle's DLC depends on the vehicle's configuration as follows:

For OBD II vehicle, directly plug the VCI device into the vehicle's DLC (OBD II extension cable is recommended).

For non-OBD II vehicle, follow either of the ways to proceed:

1. Locate vehicle's DLC socket.
2. Select the corresponding non-16pin dongle.
3. Plug the non-16pin end of the non-16pin adaptor into the DLC socket, then connect the other end to the OBD II extension cable.
4. Connect the other end of the adaptor to the included VCI device.
5. To supply power to OBD I adaptor from:

A. Cigaretter Lighter: Connect one end of the cigarette lighter cable to vehicle's cigarette lighter receptacle, and the other end to the DC-IN jack of the VCI device.

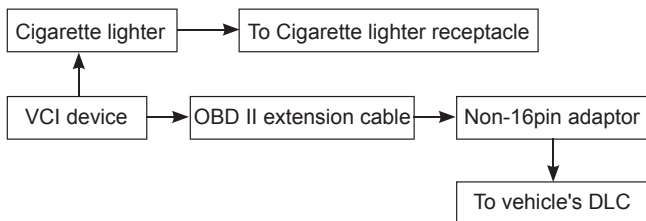

Fig. 5-4

B. Battery clamps cable: Connect one end of the battery clamps cable to vehicle's battery (Red to + & Black to -), and the other end to the DC-IN jack of the VCI device.

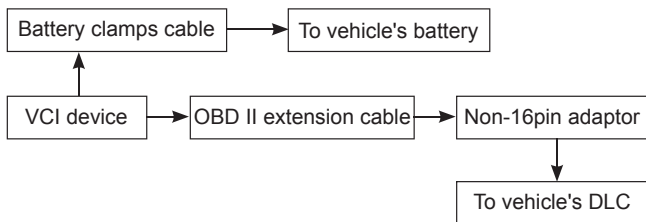

Fig. 5-5

5.2 Communication Setup

There are two kinds of ways available for the tablet to communicate with the VCI device: Wi-Fi and USB cable.

After the sign-up is successfully completed, the Wi-Fi communication between the tablet and the VCI device is automatically done and user has no need to configure it again.

The USB cable connection is a simple & quick way to establish communication between the tablet and the VCI module. After

properly connecting the USB cable from the tablet to the VCI, the VCI navigation button at the bottom of the screen becomes highlighted indicating the USB connection is successful.

*Note: The USB connection provides the most stable and fastest communication. When all communication methods are applied at the same time, the tablet will use the USB communication as the default priority.

5.3 Start Diagnostics

5.3.1 Intelligent Diagnosis

Through simple Wi-Fi communication between the tablet and VCI, you can easily get the VIN (Vehicle Identification Number) information of the currently identified vehicle. Once the VIN is successfully identified, the system will retrieve it from the remote server and then guide you to vehicle information page without the necessity of step-by-step manual menu selection.

The vehicle information page lists all historical diagnostic records of the vehicle, which lets the technician have a total command of the vehicle faults. In addition, a quick dial to local diagnosis and diagnostic function are also available on this page for reducing the roundabout time and increasing productivity.

*Notes:

- Before using this function, please make sure the VCI is properly connected to the vehicle's DLC. For detailed connection, see Chapter 5.1.3 "Vehicle Connection".
- A stable network connection is required for this function.

Follow the steps below to proceed.

1. Tap "Intelligent Diagnose" on the Job Menu to enter Fig. 5-6.

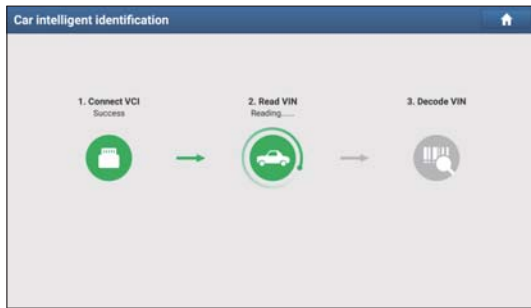

Fig. 5-6

2. After pairing is complete, the handset starts reading the vehicle VIN.
- A. If the VIN can be found from the remote server database, a screen similar to the following figure displays:

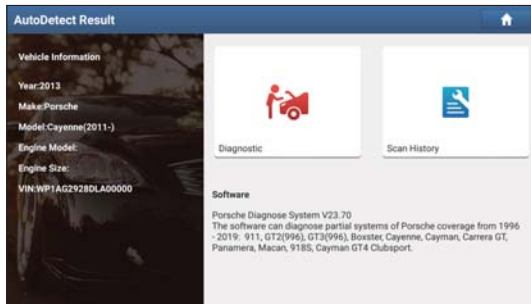

Fig. 5-7

- Tap "Diagnostic" to start a new diagnostic session.
- Tap "Scan History" to view its historical repair record. If there are

records available, it will be listed on the screen in sequence of date. If no records exist, the screen will show "No Record".

Scan History				
2019 12/04	Number of diagnostic systems:26	Quantity of DTCs:21	21:51:35	View Record
2019 12/03	Number of diagnostic systems:27	Quantity of DTCs:19	00:31:37	View Record
2019 12/01	Number of diagnostic systems:27	Quantity of DTCs:19	23:01:04	View Record
2019 11/29	Number of diagnostic systems:27	Quantity of DTCs:19	00:07:04	View Record
Porsche Cayenne(2011-) 2013 VIN WP1AG2928DLA00000				Quick Access

Fig. 5-8

- Tap "View record" to view the details of the current diagnostic report.
 - To perform other functions, tap "Quick access" to directly go to the function selection screen. Choose the desired one to start a new diagnostic session.
- B. If the handset failed to access the VIN information, the screen will display as below:



Fig. 5-9

In this mode, you need to input the VIN manually or tap  to scan it.

1) Tap  to launch the VIN recognition module.

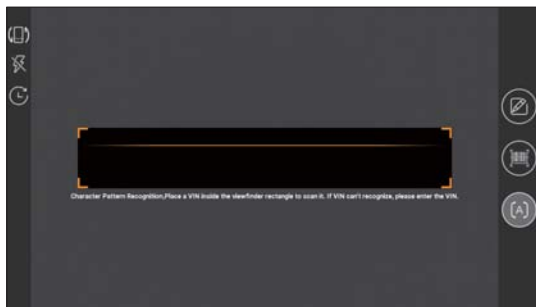







Fig. 5-10

Place the VIN inside the viewfinder rectangle to scan it. The most recognizable location for this number is in the top left corner on the vehicle's dashboard. Other locations include the driver's door or post, and the firewall under the hood.

- To switch the display orientation, tap .
- To turn the flash on, tap .
- If you have scanned the VIN of the vehicle, tap  to choose it from the record list.
- In case the handset failed to detect it, tap  to enter it manually.
- Tap  to switch the camera to barcode pattern recognition mode.
-  indicates the camera is in character pattern recognition mode (default mode).

After scanning, the screen automatically displays the result.

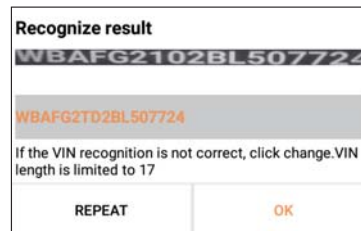

Fig. 5-11

- If the VIN scanned is incorrect, tap the result field to modify it and then tap "OK". If the VIN exists on the remote server, the system will enter the vehicle information screen. See Fig. 5-8.
 - To scan it again, tap "REPEAT".
- 2) Input the VIN, and tap "OK", the system will automatically identify the vehicle model and directly navigate to the vehicle information page.

*Note: In general, vehicle identification numbers are standardized - all contain 17 characters. VIN characters may be capital letters A through Z and numbers 1 through 0; however, the letters I, O and Q are never used in order to avoid mistakes of misreading. No signs or spaces are allowed in the VIN.

5.3.2 Local Diagnosis

Tap "Local Diagnose" to enter the vehicle selection page.

2 approaches are provided for you to access the vehicle diagnostic software. Choose any one of the following ways:

1. VINSCAN

This function enables you to access it more quickly.

In this case, automatic scan (OBD VIN) and manual input (INPUT VIN) are available.

Tap "VINScan", the screen displays as follows:



Fig. 5-12

A. **Camera Scan:** In this mode, the VCI device should be plugged into the vehicle's DLC.

Tap "Camera Scan", a screen similar to the following appears:

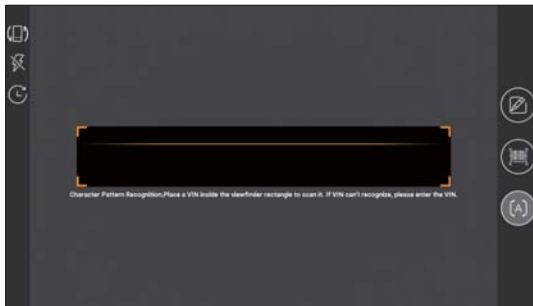







Fig. 5-13

Place the VIN inside the viewfinder rectangle to scan it. The most recognizable location for this number is in the top left corner on the vehicle's dashboard. Other locations include the driver's door or post, and the firewall under the hood.

- To switch the display orientation, tap .
- To turn the flash on, tap .
- If you have scanned the VIN of the vehicle, tap  to choose it from the record list.
- In case the handset failed to detect it, tap  to enter it manually.
- Tap  to switch the camera to barcode pattern recognition mode.
-  indicates the camera is in character pattern recognition mode (default mode).

Once the test vehicle is successfully identified, the tablet will jump to the function selection page directly.

Tap the desired option to perform the corresponding function.

*Note: Before using this function, the corresponding diagnostic software and Auto search file need to be downloaded on your tool first while downloading the diagnostic software.

B. **INPUT VIN:** In this mode, you need to input the VIN manually. In general, vehicle identification numbers are standardized - all contain 17 characters. VIN characters may be capital letters A through Z and numbers 1 through 0; however, the letters I, O and Q are never used in order to avoid mistakes of misreading. No signs or spaces are allowed in the VIN.

Tap "INPUT VIN" and a screen similar to Fig. 5-14 will appear:



Fig. 5-14

Input the VIN, and tap “Confirm”, the system will automatically identify the vehicle model and directly navigate to the function selection page.

2. Manual Selection

Tap a corresponding diagnostic software logo, and then follow the on-screen instruction to access the diagnostic software.

Take Demo as an example to demonstrate how to diagnose a vehicle.

- 1). Select diagnostic software version: Tap the “DEMO” to go to Step 2. (*Note: If more than one version is available on this tablet, it will be listed on the screen.)

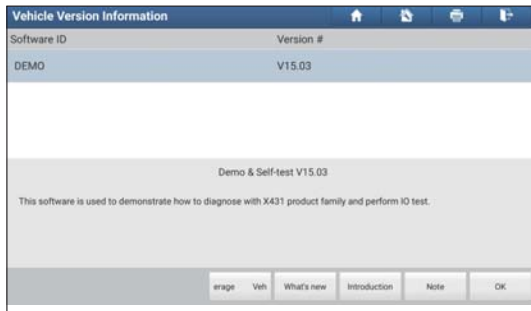

Fig. 5-15

On-screen Buttons:

Vehicle Coverage: Tap to view the vehicle models that the current diagnostic software covers.

What's new: Tap to view the optimized items and enhancements.

Introduction: Tap to check the software function list.

Note: Tap to read some precautions on using the current diagnostic software.

OK: Tap it to go to next step.

- 2). Select test item: Select the desired test item to proceed.

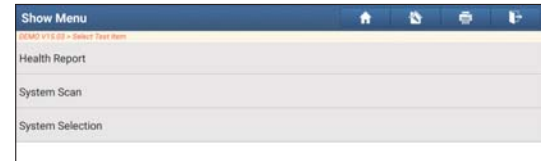

Fig. 5-16

5.3.2.1 Health Report (Quick Test)

This function varies from vehicle to vehicle. It enables you to quickly access all the electronic control units of the vehicle and generate a detailed report about vehicle health.

Tap “Health Report”, the system starts scanning the ECUs. Once the scanning is complete, a screen similar to the following appears:



Fig. 5-17

In Fig. 5-17, the tested system with fault code appears in red and the system with OK displays in white (normally).

*Note: Diagnostic Trouble Codes or Fault Codes can be used to identify which engine systems or components that are malfunctioning. Never replace a part based only on the DTC definition. Retrieving and using DTCs for troubleshooting vehicle operation is only one part of an overall diagnostic strategy. Follow testing procedures (in vehicle's service manual), instructions and flowcharts to confirm the locations of the problem.

On-screen Buttons:

∨: Tap to display the details of DTCs existing in the current system.
 Tap ^ to hide it.

Highlight certain DTC item, and tap  to open the browser to retrieve it in Google engine.

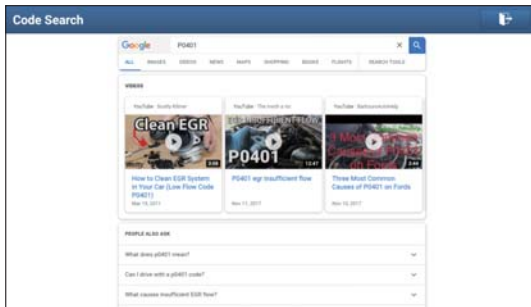

Fig. 5-18

Enter: Tap to select other test functions.



Fig. 5-19

Report: Tap to save the diagnostic result as a report.

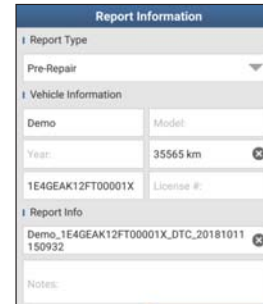
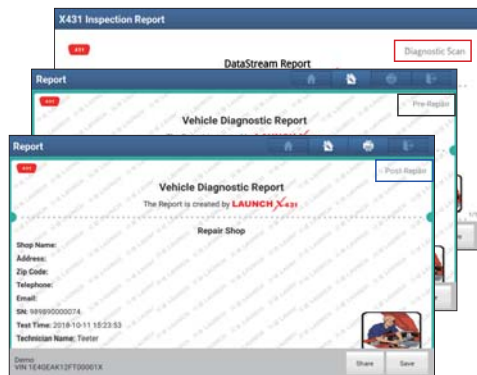

Fig. 5-20

*Note: Diagnostic report is classified into three categories: Pre-Repair report, Post-Repair report and Diagnostic Scan. No matter which type you saved the report as, the report type will be appended as a tag on the upper right corner of the diagnostic report for easier identification.



Tap \checkmark to select the report type from the option list and input the required information, and then tap "OK".

*Note: To facilitate the comparison of the pre-repair and post-repair reports and get accurate test result, please make sure you saved the right type of the diagnostic report.

To save the report as a common diagnostic report, select "Diagnostic Scan".

Fig. 5-21

Enter the technician and customer name and then tap "OK" to confirm and navigate to the report details page.

*Note: For workshop information, tap "Change" to revise it. Alternatively you can also set it in "User Info" -> "Settings" -> "Print Information".

Once you configured the information, it will be automatically generated every time you saved the diagnostic report. All vehicle and workshop information will be appended as tags on the diagnostic report.

To ignore the workshop information, tap "Skip" to go to the report details page.

On the report details page, tap "Save" to save it. All diagnostic reports can be accessed from "User Info" -> "My Reports" -> "Health Report".

Help: Tap to view the help information of the selected DTC item.

Compare Results: Tap to select the pre-repair report to compare. By comparison of the pre- and post-repair reports, you can easily identify which DTCs are cleared and which remain unfixed.

The DTC status of **post-repair** The DTC status of **pre-repair**

DTC	Post	Pre
ECM(Engine Control Module)	Cleared	Found
P0303 Misfiring of Cylinder 3(P0303)	Cleared	Found
P2097 Throttle Valve Block(ice up)	Cleared	Found
P0401 EGR Valve A Flow Insufficient Detected	Cleared	Found
P0174 System A/F Ratio too Lean (Bank 2)	Cleared	Found
TCM(Transmission Control Module)	Cleared	Found
ABS(Anti-lock Braking System)	Cleared	Found
SRS(Supplemental Inflatable Restraint System)	Cleared	Found
BCM(Body Control Module)	Cleared	Found

Fig. 5-22

*Note: Before performing this function, please make sure that:

- You have saved a pre-repair report of the currently tested vehicle, and
- You have already made some repairs and service and cleared the DTCs after the pre-repair reported is generated. Otherwise, no differences exist between the pre- and post-repair reports.

Clear DTC: Tap to clear the existing diagnostic trouble codes.

*Note: Clearing DTCs does not fix the problem(s) that caused the code(s) to be set. If proper repairs to correct the problem that caused the code(s) to be set are not made, the code(s) will appear again and the check engine light will illuminate as soon as the problem that cause the DTC to set manifests itself.

5.3.2.2 System Scan

This option allows you to quickly scan which systems are installed on the vehicle.

In Fig. 5-16, tap “System Scan”, the system starts scanning the systems. Once the scanning is complete, the screen will display the result.

System Name	Result
ECM(Engine Control Module)	Equipped
TCM(Transmission Control Module)	Equipped
ABS(Anti-lock Braking System)	Equipped
SRS(Supplemental Inflatable Restraint System)	Equipped
BCM(Body Control Module)	Equipped
IMM(Immobilizer)	Equipped
BMS(Battery Manager System)	Equipped
TPMS(Tire Pressure Monitoring System)	Equipped

Demo VIN 1E4GEAK12FT00001X

Fig. 5-23

Tap the desired system to advance to the test function selection page. For detailed operations on test function, please refer to Chapter 5.3.2.3.

5.3.2.3 System Selection

This option allows you manually select the test system and function step by step.

In Fig. 5-16, tap “System Selection”, the screen displays as follows:

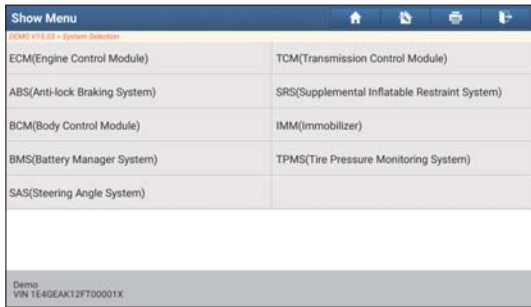

Fig. 5-24

Swipe the screen from the bottom to view the vehicle system on the next page.

Tap the desired system (take “ECM” for example) to jump to the test function page.



Fig. 5-25

*Note: Different vehicle has different diagnostic menus.

A. Version Information

This function is used to read the version information of system mode, vehicle VIN, software and ECU.

In Fig. 5-25, tap “Version Information”, the screen displays as follows:



Fig. 5-26

Tap “OK” to confirm and exit.

B. Read Fault Code

This function displays the detailed information of DTC records retrieved from the vehicle’s control system.

In Fig. 5-25, tap “Read Fault Code”, the screen will display the diagnostic result.



Fig. 5-27

*Note: Retrieving and using DTCs for troubleshooting vehicle operation is only one part of an overall diagnostic strategy. Never replace a part based only on the DTC definition. Each DTC has a set of testing procedures, instructions and flow charts that must be followed to confirm the location of the problem. This information can be found in the vehicle's service manual.

On-screen Buttons:

Freeze Frame: When an emission-related fault occurs, certain vehicle conditions are recorded by the on-board computer. This information is referred to as freeze frame data. Freeze frame data includes a snapshot of critical parameter values at the time the DTC is set.

Help: Tap to view the help information.

Code Search: Tap it to search for more information about the current DTC online.

Report: To save the current data in text format. All diagnostic reports can be accessed from "User Info" -> "My Reports" -> "Diagnostic Report".

C. Clear Fault Code

After reading the retrieved codes from the vehicle and certain repairs have been carried out, you can use this function to erase the codes from the vehicle. Before performing this function, please be sure the vehicle's ignition key is in the ON position with the engine off.

Clearing DTCs does not fix the problem(s) that caused the code(s) to be set. If proper repairs to correct the problem that caused the code(s) to be set are not made, the code(s) will appear again and the check engine light will illuminate as soon as the problem that cause the DTC to set manifests itself.

In Fig. 5-25, tap "Clear Fault Code", a confirmation dialog box pops up on the screen. Tap "Yes" and the system will automatically delete the currently existing trouble code.

*Note: After clearing, you should retrieve trouble codes once more or turn ignition on and retrieve codes again. If there are still some trouble codes in the system, please troubleshoot the code using a factory diagnosis guide, then clear the code and recheck.

D. Read Data Stream

This option lets you view and capture (record) real-time Live Data. This data including current operating status for parameters and/or sensor information can provide insight on overall vehicle performance. It can also be used to guide vehicle repair.

*Note: If you must drive the vehicle in order to perform a troubleshooting procedure, always have a second person help you. Trying to drive and operate the diagnostic tool at the same time is dangerous, and could cause a serious traffic accident.

In Fig. 5-25, tap "Read Data Stream", the system will display data stream items.

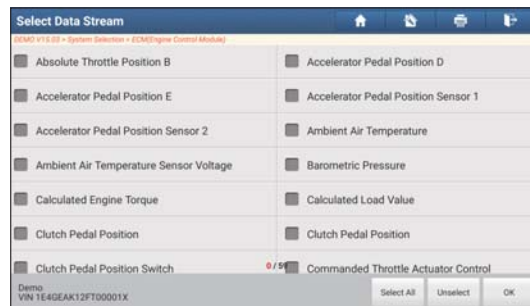

Fig. 5-28

On-screen Buttons:

Select All: Tap it to select all items of the current page. To select certain data stream item, just check the box before the item name.

Unselect: Tap it to deselect all data stream items.

OK: Tap it to confirm and jump to the next step.

After selecting the desired items, tap “OK” to enter the data stream reading page.



Name	Value	Standard Range	Unit	
Absolute Throttle Position B	16.08	0 - 100	%	
Accelerator Pedal Position D	27.84	0 - 100	%	
Accelerator Pedal Position E	6.67	0 - 100	%	
Accelerator Pedal Position Sensor 1	0.78	0 - 5	V	
Accelerator Pedal Position Sensor 2	0.39	0 - 5	V	
Ambient Air Temperature	21	-40 - 215	degree C	

Demo: VN1E4G6AK12FT00001X | Graph | Sample DS | 5 | Report | Record | Help | Sample DS

Fig. 5-29

***Notes:**

1. If the value of the data stream item is out of the range of the standard (reference) value, the whole line will display in red. If it complies with the reference value, it displays in blue (normal mode).
2. The indicator 1/X shown on the bottom of the screen stands for the current page/total page number. Swipe the screen from the right/left to advance/return to the next/previous page.

There are 3 types of display modes available for data viewing, allowing you to view various types of parameters in the most suitable way.

- Value – this is the default mode which displays the parameters in texts and shows in list format.
- Graph – displays the parameters in waveform graphs.
- Combine – this option is mostly used in graph merge status for data comparison. In this case, different items are marked in different colors.

On-screen Buttons:

 Tap it to view the waveform graph of the current data stream item.



Fig. 5-30

- **Min/Max:** Tap to define the maximum/minimum value. Once the value goes beyond the specified value, the system will alarm.

***Note:** The real time (Live Data) vehicle operating information (values/status) that the on-board computer supplies to the tool for each sensor, actuator, switch, etc. is called Parameter Identification Data (PID).

Graph: Tap it to view the waveform.



Fig. 5-31

- **Combine:** This option is mostly used in graph merge status for data comparison.

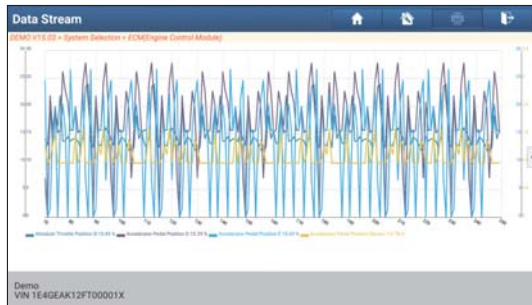



Fig. 5-32

- **Value:** Tap to display the parameters in texts.
- **Customize:** Tap , a pull-down list of the data stream items appears on the screen. Select (Maximum 8 data stream items can be selected)/deselect the desired items and then screen

will display/remove the waveforms corresponding to these items immediately.



Fig. 5-33

Select Sample DS: Tap it to select the sample DS file, the values you customized and saved in process of DS sampling will be imported into the “Standard Range”(See below) column for your comparison.

*Note: Before executing this function, you have to sample the values of data stream items and save it as an sample DS file.

Name	Value	Standard Range(Data Stream Sample)	Unit
Absolute Throttle Position B	15.29	12.16 - 18.6	%
Accelerator Pedal Position D	19.61	7.06 - 26.8	%
Accelerator Pedal Position E	21.18	0 - 25	%
Accelerator Pedal Position Sensor 1	1.11	0.78 - 1.11	V
Accelerator Pedal Position Sensor 2	0.57	0.39 - 0.8	V
Ambient Air Temperature	21 (1 / 5)	21 - 21	degree C

Fig. 5-34

Report: To save the current data as a diagnostic report. All diagnostic reports can be accessed from “User Info” -> “My Reports” -> “Health Report”.

Record: Tap to start recording diagnostic data. Recorded live data can serve as valuable information to help you in troubleshooting of vehicle problems. All diagnostic records can be replayed from “User Info” -> “My Reports” -> “Recorded Data”.

*Note: The saved file follows the naming rule: It begins with vehicle type, and then the product S/N and ends with record starting time (To differentiate between files, please configure the accurate system time).

Help: Tap to view the help information.

Sample DS: This item enables you to customize the standard range of live data stream items and save it as DS sample file. Each time you run the data stream items, you can call out the corresponding sample data to overwrite the current standard range.

Tap it to start recording the sample data (*Only data stream items with measurement units will be recorded), and the screen displays as below:

Name	Value	Standard Range	Unit
Absolute Throttle Position B	15.69	0 - 100	%
Accelerator Pedal Position D	15.29	0 - 100	%
Accelerator Pedal Position E	15.69	0 - 100	%
Accelerator Pedal Position Sensor 1	0.78	0 - 5	V
Accelerator Pedal Position Sensor 2	0.39	0 - 5	V
Ambient Air Temperature	21	-40 - 215	degree C

Demo VIN 1E4GEAK12FT00001X

Graph Select Save Report Record Help Sample DS

Fig. 5-35

Once recording is complete, tap to stop it and navigate to the data revision screen.

Name	Min Value	Max Value	Unit
Absolute Throttle Position B	12.16	18.43	%
Accelerator Pedal Position D	7.06	26.27	%
Accelerator Pedal Position E	0.0	24.71	%
Accelerator Pedal Position Sensor 1	0.78	1.11	V
Accelerator Pedal Position Sensor 2	0.39	0.57	V
Ambient Air Temperature	21.0	21.0	degree C

Demo VIN 1E4GEAK12FT00001X

Save

Fig. 5-36

Tap the Min./Max. value to change it. After modifying all desired items, tap “Save” to save it as a sample DS file. All DS files are stored under the “Data Stream Sample” file in “User Info.”.

E. Actuation Test

This option is used to access vehicle-specific subsystem and component tests. Available test vary by vehicle manufacturer, year, and model. During the actuation test, the tablet outputs commands to the ECU in order to drive the actuators, and then determines the integrity of the system or parts by reading the ECU data, or by monitoring the operation of the actuators, such as switching a injector between two operating states.

In Fig. 5-25, tap “Actuation Test”, the system will display as follows:

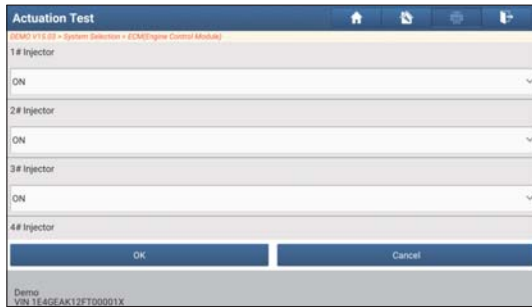

Fig. 5-37

Simply follow the on-screen instructions and make appropriate selections to complete the test. Each time when an operation is successfully executed, “Completed” displays.

5.4 Maintenance Reset

In addition to amazing & powerful diagnostic function, the tablet also features various service functions. The most commonly performed service functions contain:

- Oil Reset Service
- Electronic Parking Brake Reset
- Steering Angle Calibration
- ABS Bleeding
- TPMS (Tire Pressure Monitor System) Reset
- Gear Learning
- IMMO Service
- Injector Coding
- Battery Maintenance System

- Diesel Particulate Filter (DPF) Regeneration
- Electronic Throttle Position Reset
- Gearbox Matching
- AFS (Adaptive Front-lighting System) Reset
- Sunroof Initialization
- Suspension Calibration

There are two methods to reset service lamp: Manual reset or Auto reset. Auto reset follows the principle of sending command from the tool to vehicle's ECU to do resetting. While using manual reset, users just follow the on-screen instructions to select appropriate execution options, enter correct data or values, and perform necessary actions, the system will guide you through the complete performance for various service operations.

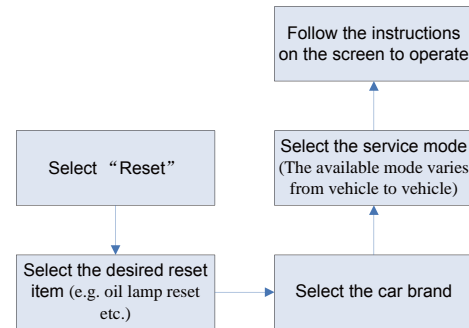

Figure 5-3

5.4.1 Oil Reset Service

This function allows you to perform reset for the engine oil life system, which calculates an optimal oil life change interval depending on the

vehicle driving conditions and climate.

This function can be performed in the following cases:

1. If the service lamp is on, you must provide service for the car. After service, you need to reset the driving mileage or driving time so that the service lamp turns off and the system enables the new service cycle.
2. After changing engine oil or electric appliances that monitor oil life, you need to reset the service lamp.

5.4.2 Electronic Parking Brake Reset

1. If the brake pad wears the brake pad sense line, the brake pad sense line sends a signal sense line to the on-board computer to replace the brake pad. After replacing the brake pad, you must reset the brake pad. Otherwise, the car alarms.
2. Reset must be performed in the following cases:
 - a) The brake pad and brake pad wear sensor are replaced.
 - b) The brake pad indicator lamp is on.
 - c) The brake pad sensor circuit is short, which is recovered.
 - d) The servo motor is replaced.

5.4.3 Steering Angle Calibration

To reset the steering angle, first find the relative zero point position for the car to drive in straight line. Taking this position as reference, the ECU can calculate the accurate angle for left and right steering.

After replacing the steering angle position sensor, replacing steering mechanical parts (such as steering gearbox, steering column, end tie rod, steering knuckle), performing four-wheel alignment, or recovering car body, you must reset the steering angle.

5.4.4 ABS Bleeding

This function allows you to perform various bi-directional tests to check the operating conditions of Anti-lock Braking System (ABS).

1. When the ABS contains air, the ABS bleeding function must be performed to bleed the brake system to restore ABS brake sensitivity.
2. If the ABS computer, ABS pump, brake master cylinder, brake cylinder, brake line, or brake fluid is replaced, the ABS bleeding function must be performed to bleed the ABS.

5.4.5 Tire Pressure Monitor System Reset

This function allows you to quickly look up the tire sensor IDs from the vehicle's ECU, as well as to perform TPMS replacement and sensor test.

1. After the tire pressure MIL turns on and maintenance is performed, the tire pressure resetting function must be performed to reset tire pressure and turn off the tire pressure MIL.
2. Tire pressure resetting must be performed after maintenance is performed in the following cases: tire pressure is too low, tire leaks, tire pressure monitoring device is replaced or installed, tire is replaced, tire pressure sensor is damaged, and tire is replaced for the car with tire pressure monitoring function.

5.4.6 Gear Learning

The crankshaft position sensor learns crankshaft tooth machining tolerance and saves to the computer to more accurately diagnose engine misfires. If tooth learning is not performed for a car equipped with Delphi engine, the MIL turns on after the engine is started. The diagnostic device detects the DTC P1336 'tooth not learned'. In this case, you must use the diagnostic device to perform tooth learning for the car. After tooth learning is successful, the MIL turns off.

After the engine ECU, crankshaft position sensor, or crankshaft flywheel is replaced, or the DTC 'tooth not learned' is present, tooth learning must be performed.

5.4.7 IMMO Service

An immobilizer is an anti-theft mechanism that prevents a vehicle's engine from starting unless the correct ignition key or other device is present. Most new vehicles have an immobilizer as standard equipment. An important advantage of this system is that it doesn't require the car owner to activate it since it operates automatically. An immobilizer is considered as providing much more effective anti-theft protection than an audible alarm alone.

As an anti-theft device, an immobilizer disables one of the systems needed to start a car's engine, usually the ignition or the fuel supply. This is accomplished by radio frequency identification between a transponder in the ignition key and a device called a radio frequency reader in the steering column. When the key is placed in the ignition, the transponder sends a signal with a unique identification code to the reader, which relays it to a receiver in the vehicle's computer control module. If the code is correct, the computer allows the fuel supply and ignition systems to operate and start the car. If the code is incorrect or absent, the computer disables the system, and the car will be unable to start until the correct key is placed in the ignition.

To prevent the car being used by unauthorized keys, the anti-theft key matching function must be performed so that the immobilizer control system on the car identifies and authorizes remote control keys to normally use the car.

When the ignition switch key, ignition switch, combined instrument panel, ECU, BCM, or remote control battery is replaced, anti-theft key matching must be performed.

5.4.8 Injector Coding

Write injector actual code or rewrite code in the ECU to the injector code of the corresponding cylinder so as to more accurately control or correct cylinder injection quantity.

After the ECU or injector is replaced, injector code of each cylinder must be confirmed or re-coded so that the cylinder can better identify injectors to accurately control fuel injection.

5.4.9 Battery Maintenance System Reset

This function enables you to perform a resetting operation on the monitoring unit of vehicle battery, in which the original low battery fault information will be cleared and battery matching will be done.

Battery matching must be performed in the following cases:

- a) Main battery is replaced. Battery matching must be performed to clear original low battery information and prevent the related control module from detecting false information. If the related control module detects false information, it will invalidate some electric auxiliary functions, such as automatic start & stop function, sunroof without one-key trigger function, power window without automatic function.
- b) Battery monitoring sensor. Battery matching is performed to re-match the control module and motoring sensor to detect battery power usage more accurately, which can avoid an error message displaying on the instrument panel.

5.4.10 Diesel Particulate Filter (DPF) Regeneration

DPF regeneration is used to clear PM (Particulate Matter) from the DPF filter through continuous combustion oxidation mode (such as high temperature heating combustion, fuel additive or catalyst reduce PM ignition combustion) to stabilize the filter performance.

DPF regeneration may be performed in the following cases:

- a) The exhaust back pressure sensor is replaced.
- b) The PM trap is removed or replaced.
- c) The fuel additive nozzle is removed or replaced.
- d) The catalytic oxidizer is removed or replaced.
- e) The DPF regeneration MIL is on and maintenance is performed.
- f) The DPF regeneration control module is replaced.

5.4.11 Electronic Throttle Position Reset

This function enables you to make initial settings to throttle actuators and returns the “learned” values stored on ECU to the default state. Doing so can accurately control the actions of regulating throttle (or idle engine) to adjust the amount of air intake.

5.4.12 Gearbox Matching

1. This function can complete the gearbox self-learning to improve gear shifting quality.
2. When the gearbox is disassembled or repaired (after some of the car battery is powered off), it will lead to shift delay or impact problem. In this case, this function needs to be done so that the gearbox can automatically compensate according to the driving conditions so as to achieve more comfortable and better shift quality.

5.4.13 AFS (Adaptive Front-lighting System) Reset

This feature is used to initialize the adaptive headlamp system. According to the ambient light intensity, the adaptive headlamp system may decide whether to automatically turn on the headlamps, and timely adjust the headlamp lighting angle while monitoring the vehicle speed and body posture.

5.4.14 Sunroof Initialization

This function can set the sunroof lock off, closed when it rains, sliding / tilting sunroof memory function, temperature threshold outside the car etc.

5.4.15 Suspension Calibration

1. This function can adjust the height of the body.
2. When replacing the body height sensor in the air suspension system, or control module or when the vehicle level is incorrect, you need to perform this function to adjust the body height sensor for level calibration.

5.5 Remote Diagnosis

This option aims to help repair shops or technicians launch instant messaging and remote diagnosis, making the repair job getting fixed faster.

5.5.1 Interface Layout

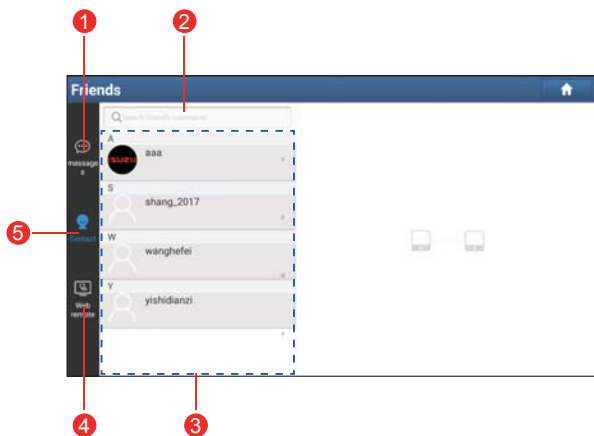

Fig. 5-39

1	Message tab	Once an incoming message reaches, a red dot will appear on the upper right corner of the tab.
2	Search bar	Directly input the login username of the tablet (App) to start searching, and then tap the desired one to add it into your friend list.
3	Friends List	By default, the screen appears blank.

4	WEB Remote switch	Tap to slide the switch to ON, the tablet keeps online and becomes visible on the web client. In this case, inform the technician of your product S/N, and he/she will control your tablet remotely.
5	Contact tab	Tap to enter the friend list.

5.5.2 Add Friends

Tap “Contact” to enter the contact page. By default it appears blank.

In the search bar, input the partner’s username and tap “Search” button next to the search bar to start searching from Launch’s golo business database.

The partner must be the users who have registered their Launch’s diagnostic tools. They may be the following:

- Workshop
- Technician
- golo users

Once the result matches the keyword, a screen similar to the following will appear:

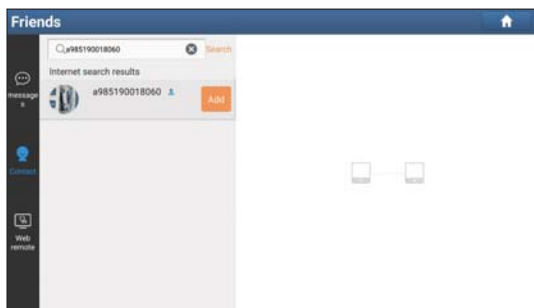

Fig. 5-40

Tap "Add", a dialog box pops up:

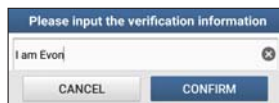

Fig. 5-41

Tap "CONFIRM" to send your request.

Once the partner receives the request, a beep will sound. Tap the "Message" tab:

- Once the partner agreed your request, he/she will automatically be listed in the Contact tab.
- If a technician sent you a friend request, you can tap "Agree" to confirm and his/her name will appear in the friend list (Contact). Or tap "Ignore" to ignore this request.

5.5.3 Start Instant Messaging

*Note: The I/M (Instant Messaging) function is open to all users who had Launch's diagnostic tool equipped with this module.

After adding your friends, tap the desired one's photo to enter a screen similar to the following:

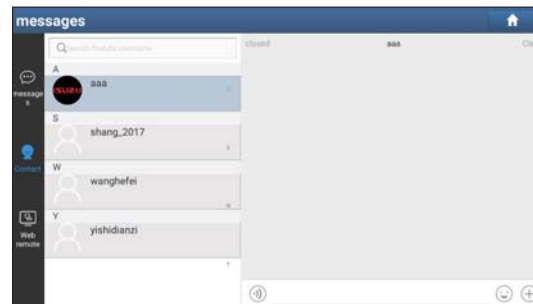





Fig. 5-42

Tap the input field and use the on-screen keyboard to enter the text message, and then tap "Send" to send it.

- Tap  to send the voice message.
- Tap  to send the emoji.
- Tap  to call out more function options.
- Tap "Clear" to delete all the partner's dialog logs.
- Tap "Close" to close the current dialog.

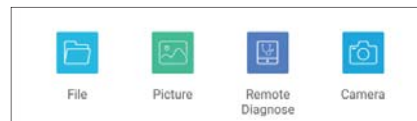

Fig. 5-43

File: Choose diagnostic reports or local files to send.

Picture: Choose screenshots or pictures to send.

Remote Diagnostic: To start a remote diagnostic session. For details, refer to Chapter 5.5.4.

Camera: Open camera to take pictures.

5.5.4 Launch Remote Diagnosis (Device-To-Device)

The tablet is allowed to initiate remote diagnosis with other diagnostic tools (including but not limited to this product) of Launch family, which are equipped with this module.

* Notes: Before performing this operation, please make sure the following no matter which side sends the remote request:

- Turn on the vehicle power supply.
- Throttle should be in a closed position.
- The tablet should be properly connected to the vehicle's DLC and a successful communication is required.

In Fig. 5-43, tap "Remote Diagnose", a pull-down menu including the following options appears:



Fig. 5-44

These options are defined as follows:

Actions	Results
Request control remote device	<p>Request to control the partner's device remotely to help him diagnose the vehicle.</p> <p>*Notes:</p> <ul style="list-style-type: none"> • Remote diagnosis has the same diagnostic steps as manual diagnosis. • In process of remote diagnosis, tap the  button to send a voice message. • Once vehicle diagnosis is complete, a report will be created. Input your comments on this report, and then tap "Send Report" to send it to the partner. • If you have a local vehicle diagnosis in process, please exit it first before starting remote diagnosis. <pre> graph TD A[Tap "Request control remote device""] --> B[Wait for partner's confirmation] B --> C[Start connecting after request confirmed] C --> D[Start Diagnosis] D --> E[Generate diagnostic report] </pre>

Invite remote diagnostic assistant

If you need support, just use this option to invite a technician to perform a remote control on your tool.

*Notes:

- Remote diagnosis has the same diagnostic steps as manual diagnosis.
- In process of remote diagnosis, tap the  button to send voice message.
- Once you received the report from the partner, tap "View Report" to view details. All diagnostic reports are saved "User Info" -> "My Report" -> "Remote Reports".

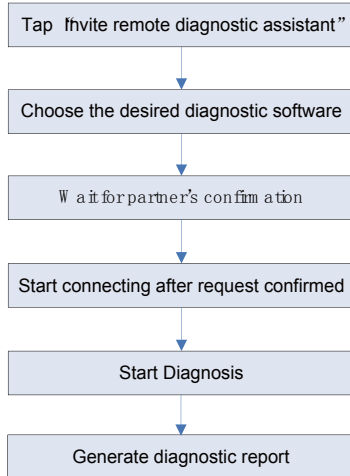

<input type="checkbox"/> ancel	<input type="checkbox"/> o cancel this operation.
--------------------------------	---

5.5.5 Launch Remote Diagnosis (Device-To-PC)

Except that the remote diagnosis can be done between different launches diagnostic tools that come loaded with the module, user also can as for remote control from client technician.

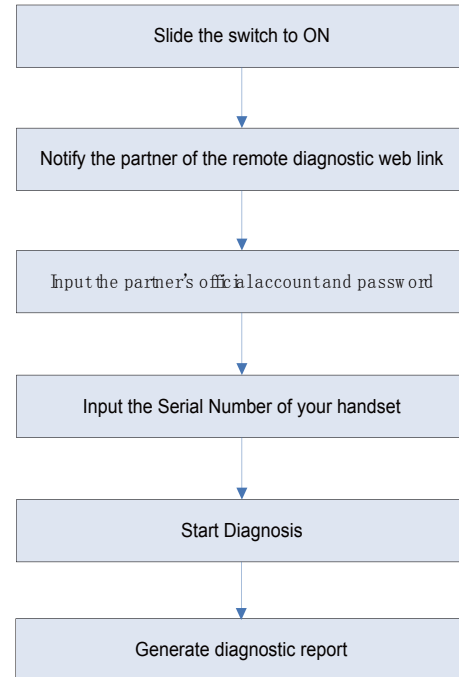

Fig. 5-45

Tap the “Web Remote” tab, the screen displays as follows:

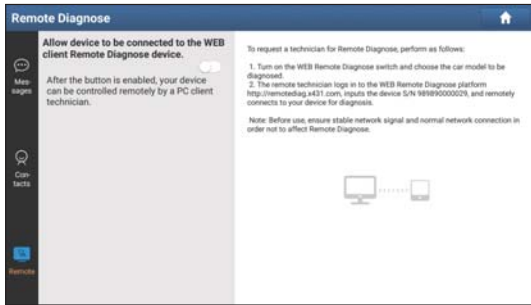

Fig. 5-46

1. Slide the switch “Allow device to be connected to the WEB client remote diagnostic device” to ON so that the partner can find and connect to this device while using the PC.
2. Notify the partner of the PC client website <http://remote.x431.com/cn/>. When the partner accesses the link, the PC displays as below:

*Note: Before processing remote diagnosis, please make sure the tablet is properly connected to the vehicle.

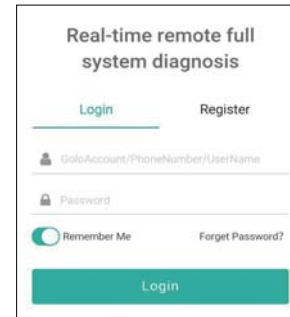

Fig. 5-47

3. Tell the partner to input his own official technician account and password, and then tap “Login” to navigate to the following figure.

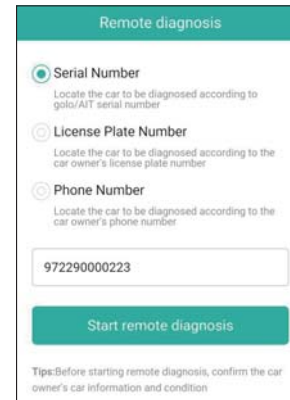

Fig. 5-48

4. Tell the partner to check the box “Serial number” and enter the

Serial Number provided by you, and then tap “Start remote diagnosis” to control your device remotely.

In process of remote diagnosis, please note the following things:

- 1) You are not suggested to execute any actions.
- 2) The partner is not allowed to save any diagnostic reports or records on your tablet.

The operations in remote diagnosis are same as those in local diagnosis. Once the session is complete, a remote diagnostic report will be automatically generated.

5.6 Diagnostic History

Generally once a vehicle diagnosis is performed, the tablet will record the every details of diagnostic process. The History function provides a quick access to the tested vehicles and users can resume from the last operation, without starting from scratch.

Tap “History”, all diagnostic records will be listed on the screen in date sequence.

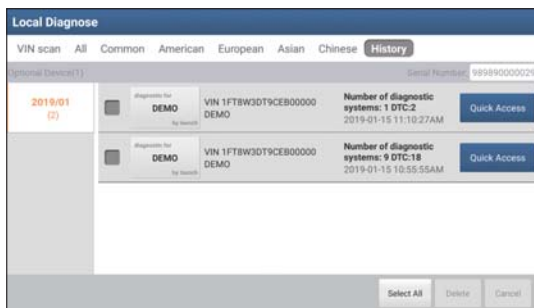

Fig. 5-49

- Tap certain vehicle model to view the details of the last diagnostic

report.

- To delete certain diagnostic history, select it and then tap “Delete”. To delete all historical records, tap “Select All” and then tap “Delete”.
- Tap “Restore” to directly navigate to the function selection page of last diagnostic operation. Choose the desired option to proceed.

5.7 Software Update

This module allows you to update the diagnostic software & App and set frequently used software.

If you did not download the software in process of product registration or a pop-up message prompting you that some new software can be updated, you may use this option to download it or keep it synchronized with the latest version.

5.7.1 Update Diagnostic Software & APP

Tap “Software Update” on the Home screen to enter the update center.

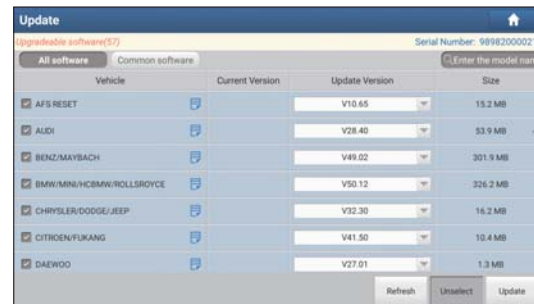

Fig. 5-50

By default, all diagnostic software is selected. To deselect certain

software, tap “Unselect”, and then check the box next to vehicle model. Tap “Update” to start downloading. It may take several minutes to finish it, please be patient to wait. To pause downloading, tap “Stop”. To resume it, tap “Continue”. If network connection failure occurs, tap “Retry” to try again.

Once download is finished, the software packages will be installed automatically.

5.7.2 Set Frequently Used software

To easily locate and quickly update some frequently used software, you can use the “Common Software” option to create a frequently used software list.

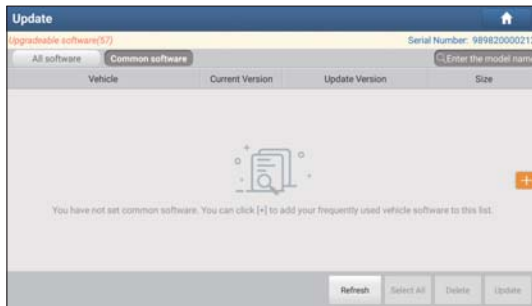

Fig. 5-51

Tap “Common software” tap “+”, a pop-up window appears. Select the checkbox before the software name and tap “SAVE”, the software will be displayed in the Common software list. Next time you want to update it, just go to “Common Software”.

5.8 Store

If the software subscription is due or expires, user can go to “Local Diagnose” -> “Store” to make a subscription renewal.



Fig. 5-52

Tap “Configuration renewal” to enter.

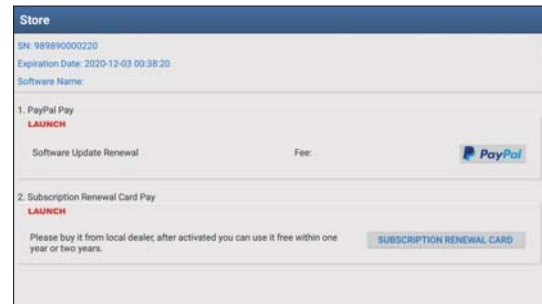

Fig. 5-53

There are two ways available for you to make payment: PayPal and

Subscription Renewal Card (*need to buy it from the local dealer where you purchased the tool).

A. Using PayPal

1. Tap “Renewal” on the update page to navigate to the renewal type selection screen.
2. Select “PayPal”, and then follow the on-screen instructions to finish the transaction.
3. After payment, go to update center to update the diagnostic software.

B. Using Subscription Renewal Card

1. Tap “Renewal” to navigate to the renewal type selection screen.
2. Select “Subscription Renewal Card”.

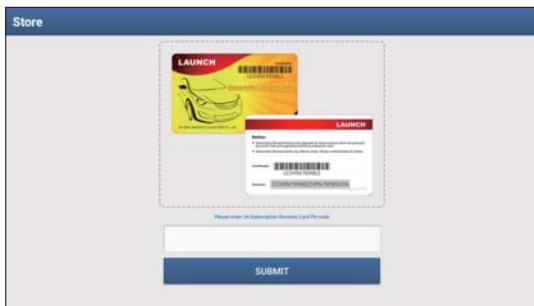

Fig. 5-54

3. Input the 24-digit password of Subscription Renewal Card and then tap “Submit” to finish the renewal.
4. Go to the update center to update the diagnostic software.

5.9 ADAS

Advanced Driver Assistance Systems (ADAS) are electronic components in vehicles, which include a wide range of safety features for vehicles such as autonomous emergency braking (AEB), lane departure warning (LDW), lane keep assist, blind spot elimination, night vision cameras and adaptive lighting.

The cameras and sensors used by these systems have to be precisely calibrated and adjusted. Incorrect calibration resulting from windscreen replacement or wheel alignment can cause the system to deliver incorrect results or even fail completely, resulting in a serious accident or even a fatality.

The ADAS feature on this diagnostic tool is disabled by default and user needs to activate this feature with the Activation Code (optional) before performing this function. Moreover, it also requires the diagnostic tool to work with the X-431 ADAS PRO calibration tool manufactured by LAUNCH (calibration tools from other manufacturers will not be supported). As a comprehensive and flexible calibration tool, the X-431 ADAS PRO calibration tool enables you to effectively and accurately calibrate a wide range of camera-based & radar-based driver assistance systems, e.g. the front camera for the lane departure warning system, the radar sensor for the ACC (Adaptive Cruise Control) or the camera for adaptive headlights.

Follow the steps below to activate it.

1. Tap “ADAS Calibration”.

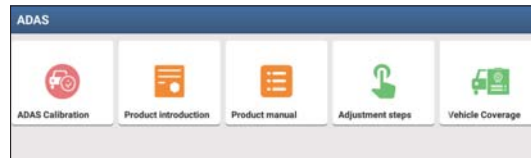

Fig. 5-55

2. Tap “Activate” to enter the ADAS activation screen.

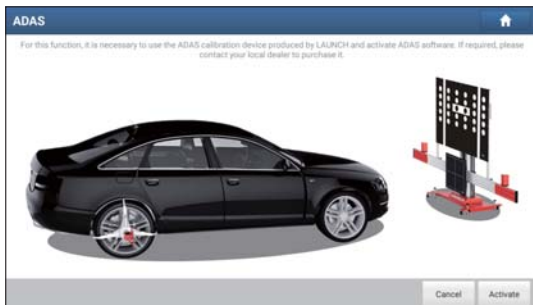

Fig. 5-56

3. Scratch or scrap the designated area on the Activation Card to reveal the password, and input the 24-digit password to activate it.



Fig. 5-57

4. Now the ADAS function becomes accessible and is ready for use.

5.10 Feedback

This item allows you to feedback your diagnostic problems to us for analysis and troubleshooting.

Tap “Feedback”, the following 3 options will be displayed on the left

column of the screen.

A. Feedback

Tap a tested vehicle model to enter the feedback screen.

- 1) Tap “Choose File” to open the target folder and choose the desired diagnostic logs.
- 2) Choose the failure type and fill in the detailed failure description in the blank text box and telephone or email address. After inputting, tap “Submit Result” to send it to us.

B. History

Tap it to view all diagnostic feedback records. Different process states are marked with different colors.

C. Offline list

Tap it to display all diagnostic feedback logs which have not been submitted successfully due to network failure. Once the tablet gets a stable network signal, it will be uploaded to the remote server automatically.

6 User Info

6.1 My Report

This option is used to view, delete or share the saved reports.

Tap “My Report”, there are total 3 options available.

In case the DTC result is saved on Read Trouble Code page, the files will be listed under Health Report tab.

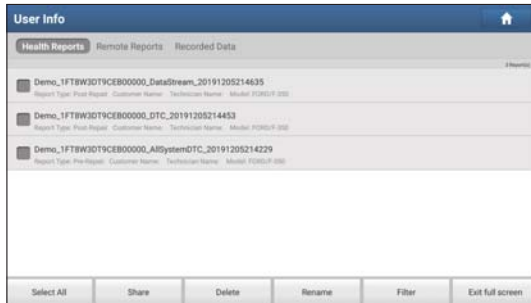

Fig. 6-1

- To select certain report, check the box before the report. To select all reports, tap “Select All”. To deselect all, tap “Unselect”.
- To share the report with others, select the desired one and then tap “Share”.
- Select the desired report and then tap “Delete” to delete it.
- To change the filename of report, tap “Rename”.
- To quickly locate the desired report, tap “Filter”.
- To exit the full screen, tap “Exit full screen”.

If user records the running parameters while reading data stream, it

will be saved as .x431 file and appear under Recorded Data tab.

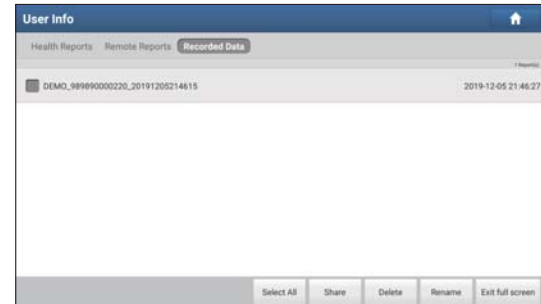

Fig. 6-2

Tap the desired one to enter:



Fig. 6-3

Select the desired data stream items and tap “Confirm” to jump to the playback page:

Diagnostic Record				
Name	Value	Unit	English	Metric
Absolute Throttle Position B	16.47	%		
Accelerator Pedal Position D	15.29	%		
Accelerator Pedal Position E	0	%		
Accelerator Pedal Position Sensor 1	0.78	V		
Accelerator Pedal Position Sensor 2	0.39	V		
Ambient Air Temperature	(1 / 2) 21	degree C		

Fig. 6-4

On-screen Buttons:

Graph – displays the parameters in waveform graphs.

Value – this is the default mode which displays the parameters in texts and shows in list format.

Combine – this option is mostly used in graph merge status for data comparison. In this case, different items are marked in different colors.

Frame Playback – plays back the recorded data stream items frame by frame. Once it is in frame playback mode, this button changes into “Auto Playback”.

Remote Diagnostic Report lists all diagnostic reports generated in process of remote diagnosis.

6.2 VCI

This option allows you to manage all your activated VCI devices.

If several VCI connectors are activated on this tool, a list of connectors will be displayed on the screen. Once you choose the connector that belongs to other account, you have to log out, and then input the right account to continue.

6.3 Immobilizer Programmer

X-PROG Immobilizer programmer is specially designed to read and write vehicle key chip data, clone and produce exclusive keys. It only works together with LAUNCH-specific diagnostic tool to accurately read and write the data in a quick and reliable manner.



X-PROG Immobilizer Programmer

It only applies to the vehicle with 12V battery voltage and OBD II diagnostic socket.

Please bind X-PROG to LAUNCH-specific diagnostic tool before using to ensure they can work together.

CAUTION

There are only three chances available for you to bind/unbind the X-PROG to/from the scanner. Pay extreme caution to do such operations.

Before binding, connection must be made. Refer to the user manual included with this device for detailed connection.

6.4 Activate VCI

This item lets you activate a new VCI device.



Fig. 6-5

Input the Serial Number and Activation Code, and then tap “Activate” to activate it.

For details on how to obtain Activation Code, tap the link below to get help.

6.5 Fix connector firmware/system

Use this item to upgrade and fix diagnostic firmware. During fixing, please do not cut power or switch to other interfaces.

6.6 My News

This option allows you to receive some commercial and promotional activity messages.

6.7 Data Stream Sample

This feature allows you to manage the recorded data stream sample files.

6.8 Vehicle Voltage

This item is used to detect the voltage of the currently tested vehicle

when the VCI is plugged into the vehicle’s DLC.

6.9 My Order

This item allows you to check the status of all your orders.

6.10 Subscription Renewal Card

This item is used to check the status of the subscription renewal card.

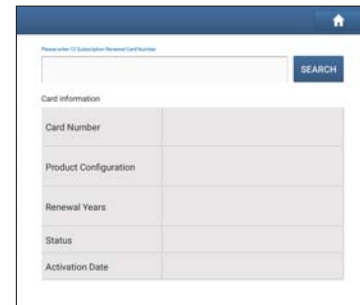

Fig. 6-7

1. Input the 12-digit subscription renewal card number.
2. Tap “Search” to get the search result.

6.11 Profile

Use this item to view and configure personal information.

- Tap the user image to change it.
- Tap > next to “Free Upgrade Period” to check the due date of all diagnostic software.

6.12 Change Password

This item allows you to modify your login password.

6.13 Settings

It enables you to make some application settings and view software version information etc.

6.13.1 Units

It is designed to configure the measurement unit. Metric System and English System are available.

6.13.2 Shop Information

This option lets you define your print information. It mainly includes Workshop, Address, Telephone, Fax and License Plate.

After inputting, tap “Save”.

Once you saved the print information, it will be entered automatically in the “Add Information” box every time you save the diagnostic report.

6.13.3 Printer Set

This option is used to establish a wireless connection between the tablet and the printer (sold separately) while performing printing operations.

The App is compatible with the “LAUNCH Wi-Fi Printer” (sold separately) and “System” printer (external printers loaded with Wi-Fi hotspot).

Here we take “LAUNCH printer” for example to demonstrate how to configure the printer.

1. Tap “Printer Set”.

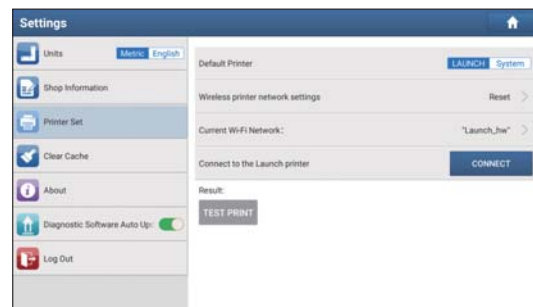

Fig. 6-8

1. If it is the first time you have operated this printer, please proceed the following:
 2. For initial use, you are suggested to reset the printer: Press and hold [MODE] & [FEED] for 8 seconds, the following resetting command will be printed out:

```
at + default = 1
ok
at + reboot = 1
rebooting...
```
 3. Tap “Reset” to configure Wi-Fi printer.

Step 1: Connect the printer:

Tap “Scan” to start scanning and select the desired printer hotspot named with X-431PRINTER-XXXX (XXXX stands for 4 characters), and then tap “Connect” to enter Step 2.

Step 2: Join the Wi-Fi printer into LAN:

Tap “Scan” to select the desired local Wi-Fi network from the list, and type in the security password (If it is an open network,

password is not required), and then tap “Confirm”.

- Once the Wi-Fi network of the printer is connected and the printer is found, tap “Printing test” to test the printing.

Now you can use the Wi-Fi printer to print!

If the printer is not found, please reset the printer to default factory settings (refer to Step 2 for details) and check whether the current device and the printer are on the same LAN.

B. If you have configured the Wi-Fi printer to the LAN:

2. Tap “Connect to Printer”:

- If the local network remains as it is, tap “Test Print” directly to test the printing.
- If the local network changes, you have to reset the Wi-Fi printer.

6.13.4 Clear Cache

This item is used to clear the App cache.

Tap “Clear Cache”, a pop-up window will appear on the screen. Tap “OK” to clear cache and the system will restart the App.

6.13.5 About

The software version information and disclaimer are included.

6.13.6 Diagnostic Software Auto Update

This option is used to set whether automatic update function is ON.

6.13.7 Login/Exit from current account

To logout the current user ID, tap “Exit from current account”.

To login the system again, tap “Login”.

6.14 Diagnostic Software Clear

This item allows you to hide/clear the diagnostic software that is not frequently used.

Tap “Diagnostic Software Clear”, the screen displays as follows:

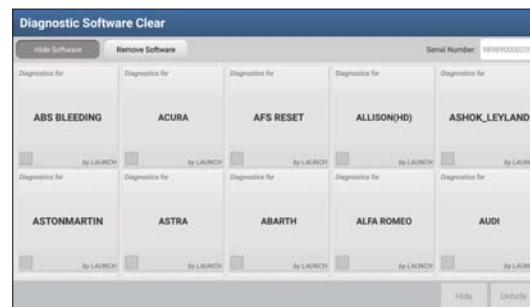

Fig. 6-9

Under the “Hide Software” tab, select the desired software logo (a “Checkmark” will show in the checkbox located at the lower right corner) and tap “Hide”, it will become invisible. Tap “Unhide” to undo the hide operation.

Under the “Remove Software” tab, select the desired software logo and tap “Delete”, it will disappear from the screen.

*Note: Removing software may completely delete the software from the tablet. If some software is not used and the tablet runs out of space, you can use this feature to remove it. To re-download it, go to “Update” -> “All Software”.

7 ToolBox

7.1 Sensorbox & Multimeter (Optional)

7.1.1 Product summary

The tablet provides an optional function of automotive sensor simulation test. "Sensor" function is specially designed to diagnose and simulate vehicle sensor faults quickly and conveniently, including "DC voltage simulation", "Fixed frequency simulation", "Predefined waveform simulation" and "Hand-painted waveform simulation".

Vehicle sensors are the signal input devices for electrical control systems, which can transform all kinds of running parameters, such as vehicle speed, coolant temperature, engine RPM, air flow, throttle opening, etc., into the electronic signal for the vehicle computer who can optimize the engine running status per the above-mentioned parameters to keep the engine working in a prime status.

Meanwhile, it integrates the functions of automobile multimeter, which enables users to perform voltage, resistance and frequency test. (The function utilizes the same hardware device as the sensor module)

It features automotive sensor simulation test and multimeter test function.

Sensorbox

Parameters	Scope
Precision	±5%
Voltage range	-5V~+5V
Max output current	70mA
Predefined frequency range	0~150Hz

Square-wave signal pulse frequency	0~15KHz
Square-wave signal duty ratio	10%~90%

Multimeter

Parameters		Scope
Precision		±5%
Voltage test	Testing range	DC-400V~+400V
	Input impedance	10Mohm
Resistance test	Testing range	0~40Mohm
Frequency test	Testing range	0~25KHz
	Input impedance	1000Gohm
	Input voltage	1~12V

7.1.2 Components and Accessories

7.1.2.1 Components & controls

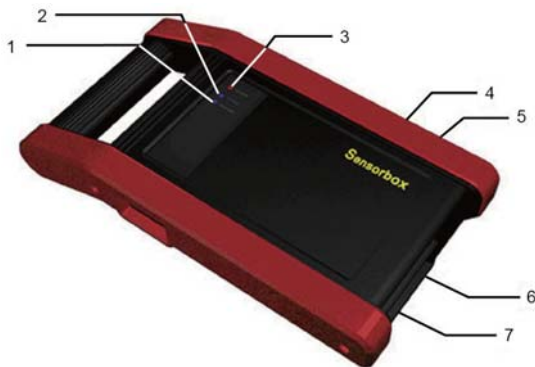

Sensorbox

Below shows the ports and indicators for the Sensorbox



No.	Name	Description
1	Data receiving LED	Indicator (green) for receiving data from the diagnostic tool.
2	Data sending LED	Indicator (green) for sending data to the diagnostic tool.
3	Power LED	It keeps steady on (red) after the Sensorbox is powered on.
4	B-shaped data I/O port	Connect to the diagnostic tool with data cable.





5	Power Interface	Connect to power supply through the power adaptor.
6	COM	Common terminal of multimeter
7	VΩHz	Testing terminal of multimeter

7.1.2.2 Accessories

The Sensorbox accessories include sensor test cable, probe etc. For detailed items, please see the packing list.

Below formulates the Sensorbox accessories:

No.	Name	Picture
1	Sensor test cable	
2	Sensor probes	
3	Data Cable	 Connects the Sensorbox and diagnostic tool so that the sampled signal can be displayed on the diagnostic tool.

4	Power adapter	 <p>To supply power to the Sensorbox through connection to AC outlet.</p>
5	Battery clamps cable	 <p>To supply power to the Sensorbox through connection to vehicle's battery.</p>
6	Electronic control converting cord 1	
7	Electronic control converting cord 2	

7.1.3 Sensor Simulation

7.1.3.1 Connections

1. Firstly, power on the diagnostic tool.
2. Connect the B-shaped terminal of data cable to the B-shaped port of the Sensorbox, and the other end to the Data I/O port of the diagnostic tool.
3. Plug one end of the sensor test cable (black) into the "COM" interface of the Sensorbox, then connect the other end to the test probe or electronic control converting cable.
4. Connect one end of the sensor test cable (red) into the "VΩHz" interface of the Sensorbox, and then connect the other end to the test probe or electronic control converting cable.

*Note: Choose corresponding cables and test probes according to different terminals.

7.1.3.2 Simulation test

Simulation test enables users to exactly judge if the sensor is good or not to avoid replacing components blindly. For example, the trouble code indicates the fault is in water temperature sensor itself. But we need to confirm whether the fault results from water temperature sensor or the connections between ECU and sensors, or ECU itself. In this case, we can make full use of simulation test to input the signal of simulating water temperature sensor, instead of water temperature sensor, to the microcomputer. If the engine works better and the fault vanishes, the fault is in the water temperature sensor. If the fault still occurs, input the signal to the corresponding terminals of ECU. Consequently, if the fault disappears, the fault lies in the connection between water temperature sensor and ECU, otherwise, the fault exists in ECU.

After all connections are properly made, power on the diagnostic tool,

launch the application and enter the “Toolbox” function menu interface, then tap “Sensor” to enter the test selection screen.

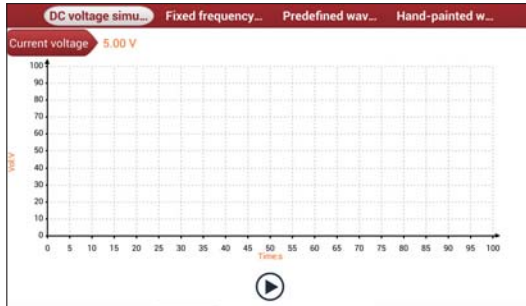

Main menu screen

1. DC voltage simulation

On the main menu screen, tap [Current voltage], then tap “+” or “-” to adjust the output voltage value. Alternatively, user can also tap edit box, then use the on-screen keyboard to input the desired value directly. After selecting or inputting the desired voltage based on the working characteristics of sensor, tap the play button, then the tablet will begin to output the simulation voltages. Please note the red probe is the output terminal of simulation voltage.

2. Fixed frequency simulation

This option enables you to simulate the square wave signal of pulse frequency of 0.1 ~ 15 kHz, amplitude range of -5V ~ +5 V and duty cycle 10% ~ 90%.

On the main menu screen, tap “Fixed frequency simulation” to enter a screen similar to the following figure.

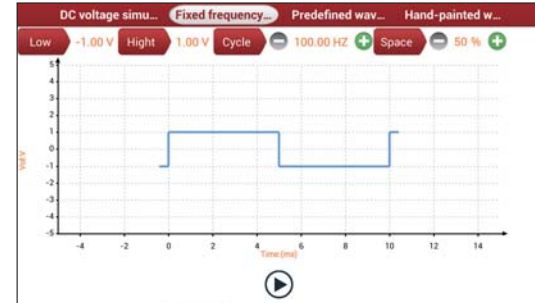

Tap the setting option tab, then tap “+” or “-” to adjust the output, After setting, tap play button to perform the test.

3. Predefined waveform simulation

The tablet provides some common sensor waveforms which have been predefined to facilitate users to simulate sensor signals. As long as you call out the predefined waveform, then tap play button to start simulating output of corresponding sensor waveform and no more parameter settings of simulation waveform are required.

On the main menu screen, tap “Predefined waveform simulation” to enter the following screen.



Here, tap  button, a screen similar to the following figure will appear.

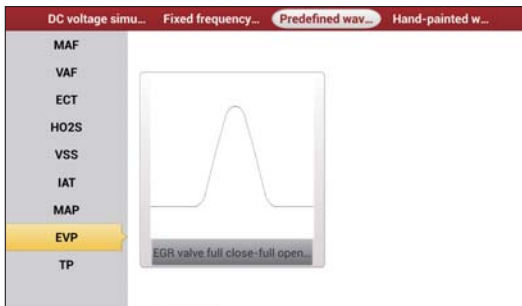

In above figure, the left setting column stands for sensor types and the right area displays waveform. The sensor types are explained as below:

- ECT: Coolant Temperature Sensor
- EVP: EGR Valve Position Sensor
- HO2S: Heated Oxygen Sensor
- IAT: Intake Air Temperature Sensor

- MAF: Mass Air Flow Sensor
- MAP: Manifold Absolute Pressure Sensor
- TP: Throttle Position Sensor
- VAF: Volume Air Flow Sensor
- VSS: Vehicle Speed Sensor

For example, tap “ECT” – “Warm (NTC Thermistor)”, the right screen will display the waveform of the sensor.

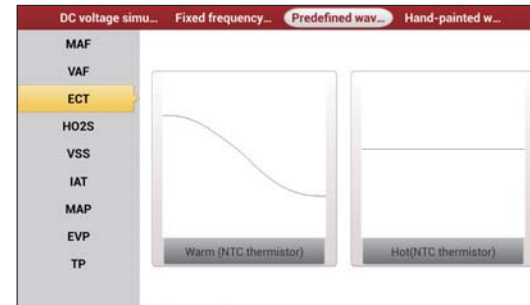

Tap the waveform, then the pre-defined waveform has been set.

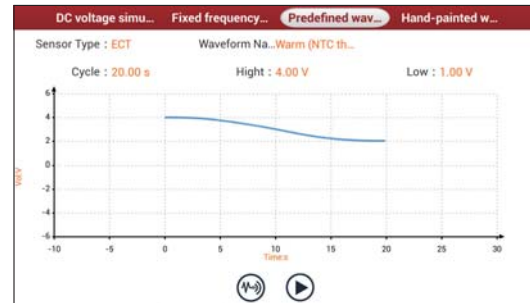

PWS-3

Tap  button to perform simulation test.

4. Hand-painted waveform simulation

This option offers great convenience for users to simulate special waveform or fault wave. Users only draw the shape of waveform which needs to be simulated in central drawing area, and then configure some parameters on the top, namely high level, low level, and cycle of waveform, then tap , the tablet will output a waveform as desired.

! WARNING Just draw a complete periodic waveform (when it is outputted, the system will regard the waveform in the drawing area as a periodic one). Users should draw as large as wave in drawing zone so that the system can sample more points to reduce tolerance. While drawing, just pay attention to the shape of waveform, high level, low level and period can be ignored, which can be set in the Configure option.

On the main menu screen, tap “Hand-painted waveform simulation”, a screen similar to the following figure will appear.



Button descriptions:

: Save the current waveform.

: Loads the previously saved hand-drawn waveform.

: Clear all hand-drawn waveform.

: Tap to call out the predefined waveform for reference.

: Continues the following operation.

7.1.3.3 Precautions on checking vehicle sensor

- Hold the connector when plugging or unplugging it. Do not pull the cable for unplugging.
- At first check the fuse, fusible line and terminals. Then check others after eliminating these faults.
- When measuring voltage, the ignition switch should be on and the battery voltage should not be less than 11V.
- When measuring voltage, please shake the lead lightly in the vertical and horizontal direction for more precision.
- When checking whether there is open in the line, disconnect the CEU and the relevant sensor at first, then measure the resistance among the ports of sensor in order to determine whether open-circuit / contact fault exists or not.
- When checking if there is a short in the line, please disconnect the CEU and the relevant sensor, then measure the resistance value of the ports between the connected port and the vehicle body. If the resistance value is more than 1MΩ, no fault occurs.
- Before disassembling the engine electrical control system cable, cut off the power supply, that is, turn the ignition switch OFF and disconnect the cables on the battery poles.
- Contact the test probe and the two terminals/ the two leads to be measured when measuring the voltage between the two terminals or the two leads.
- Contact the red test probe to the terminal/ the cable to be

measured, and the black probe to the ground when measuring voltage of one terminal/ one cable.

- When checking the continuity of the terminals, contacts and leads, the method for measuring their resistances can be used.
- Check the faults in the terminals of the CEU to sensors, relays, etc.
- There are two test probes in the testing wire. The black one is the common signal terminal (signal GND); the red one is the input terminal for voltage, resistance, and frequency test and output terminal for simulation voltage, simulation frequency and oxygen sensor. Please choose the correct probes to match the different terminals.

7.1.4 Multimeter

7.1.4.1 Operations

Make sure the diagnostic tool and the Sensorbox are properly connected, power on the diagnostic tool and enter the Toolbox menu interface, tap "Multimeter" to display the test menu.

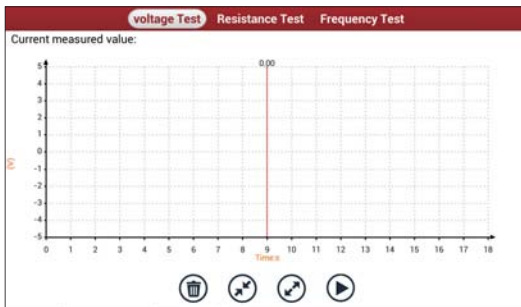

Click the desired test as shown above to perform related test.

The operation method on **Resistance test** and **Frequency test** is identical to that of Voltage test. Here just take Voltage test as an

example for demonstration.

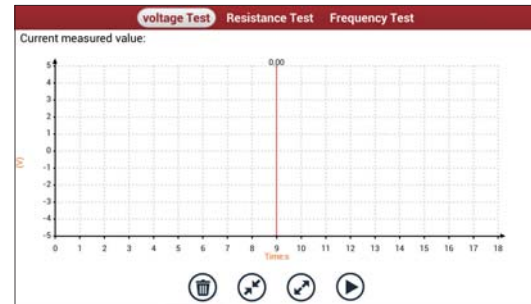

The following operations can be done:

[🗑️]: Erases the currently displayed waveform and display it starting from the left.

[🔍]: Reduces the range and zoom in the waveform.

[🔍]: Increase the range and zoom out the waveform.

[▶️]: Starts or stops the testing process.

7.1.4.2 Test sample

Knock sensor testing

(1) Resistance test for knock sensor

Switch ignition "OFF", unplug the wire connector of knock sensor, test the resistance between the wire terminal and the case of knock sensor with "Resistance test" function, it shall be ∞ (disconnected), and if it is 0Ω (conductive), which means the knock sensor shall be replaced. For the magnetostriction knock sensor, it can also test the resistance by the "Resistance measurement" function; the resistance shall be compliant with the specified value (see specific service manual for the detailed data), otherwise, the knock sensor shall be replaced.

(2) Checking for the output signal of knock sensor

Unplug the wire connector of knock sensor, check voltage between knock sensor connector terminal and ground wire of knock, it should be output pulse voltage; otherwise, the knock sensor shall be replaced.

Coolant temperature sensor testing(1) Resistance test for coolant temperature sensorOn vehicle testing:

Switch ignition "OFF" and unplug the wire connector of coolant temperature sensor, then use the "Resistance measurement" to test the Resistance between two terminals of sensor. The relationship between the resistance and the temperature is in inversely proportion (negative temperature coefficient), which shall be less than 1k Ω during warming up.

Independent testing:

Unplug the wire connector of coolant temperature sensor, then remove the sensor from the engine; place the sensor into a breaker with water and heat the water, then use the "Resistance measurement" to test the Resistance between two terminals of coolant temperature sensor at different water temperature. Compared the measured value with the standard value, if the Resistance is not compliant with the standard, then the coolant temperature sensor shall be replaced.

(2) Output signal voltage testing for coolant temperature sensor

After installing the coolant temperature sensor, plug the wire connector of sensor, and then switch ignition ON, test the output signal voltage between the two terminals of wire connector. The tested voltage shall be in inverse proportional with the coolant temperature. When the harness of coolant temperature sensor is disconnected, the voltage shall be about 5V if the ignition switch is ON.

7.2 Battery Tester (V1.0, Optional)**7.2.1 Product Summary**

The tablet provides an optional function of automotive battery test, which adopts the latest state-of-the-art conductance testing technology in the world and can test vehicle's battery status. Two testing environments (Inside the Vehicle and Outside the Vehicle) are available and applicable to battery test. In addition to battery test, charging system and actuation system test can be done while Inside the Vehicle is selected.

It supports various battery standards and specifications, including CCA, DIN, IEC, EN, JIS, SAE and GB etc. It is specifically designed to help car owner, repair workshop, battery factory use battery test instrument properly and determine whether the battery is normal or not.

Battery test aims to check starting plumbic acid storage batteries for vehicles, ship, boats and aviations, etc. It can test all kinds of batteries complying with CCA, DIN, JIS, EN, GB and SA standards. For detailed test standards, see the following table.

Standards	Standard (Full name)	Test capacity range
CCA	Battery Council International	100~1700
DIN	Deutsche Industry Normen	100~1200
JIS	Japanese Industry Standard	26A17~245H52
EN	Europe Norm	100~1700
IEC	National Electrical Commission	100~1200
GB	Chinese National Standard	100~1200

SAE	Society of Automotive Engineers	100~1700
-----	---------------------------------	----------

7.2.2 Test Environment

7.2.2.1 Test environment

Inside the vehicle test indicates that the battery connects to loading devices, such as engine, etc. After doing battery test, it can perform charging system and actuation system test, which is proceeded as a whole simultaneously. Charging system and actuation system test is not required but must not be performed before battery test. Because it is difficult for vehicle technicians to judge where is faulty exactly if they have the faintest idea of battery's status itself.

Outside the vehicle test indicates that the battery is disconnected from all loading devices on vehicles. Therefore, only battery test is supported in this condition.

7.2.2.2 Battery status and description

There are mainly 5 states as follows:

No.	States	Descriptions
1	Good battery	Indicates battery is normal.
2	Replace battery	Indicates that battery is aged or becomes rejected, or battery life cycle approaches to be exhausted. In this case, battery voltage appears to be normal, but battery itself is not well, i.e. battery polarity board has been completely vulcanized or aged. Please replace battery immediately.

3	Good-recharge	Stands for low battery. The battery is good itself.
4	Charge-retest	It is better for a few batteries to be fully charged before testing in order to avoid judging in error under special conditions.
5	Bad cell	Indicates one of the battery cells is bad and can not work normally, but for which one is bad, it can't be verified. In this case, battery voltage is generally lower than 11V, mainly resulting from internal circuitry damage, such as short circuit, open circuit, dummy weld etc.

7.2.3 Components and Accessories

7.2.3.1 Components & controls

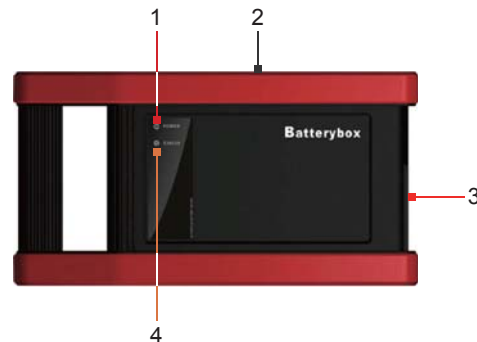

Batterybox

Below describes the ports and indicators for the Batterybox.

No.	Name	Descriptions
1	Power LED	It keeps solid red after the Scopebox is powered on.
2	B-shaped data I/O port	Connect to the diagnostic tool via data cable so that the signal can be displayed on the tool.
3	Battery connector	Connect the Kelvin clip to battery for battery test.
4	Status LED	

7.2.3.2 Accessories



Kelvin clip



Data cable

7.2.4 Connections & Operations

7.2.4.1 Connection

Connect one end of the data cable to the B-shaped data I/O port of the Batterybox, and tighten the captive screws, and then connect the other

end to the Data I/O port of the diagnostic tool. This connection applies to outside the vehicle test and inside the vehicle.

*Notes:

1. Wait about 10s and begin to communicate since the Batterybox needs to initialize after connection is complete, otherwise, communication may fail.
2. Red LED on the Batterybox means it has been successfully powered up. If the green LED is always on, it indicates the clip is well connected; while the green light blinks, it indicates that the clip has poor contact. Do not perform any test until the clip and data cable are properly connected.

7.2.4.2 Inside the vehicle test

Battery test and charging system & actuation system test can be done in this mode.

1. Battery test

Enter the battery test main menu screen, and select a desired test environment.

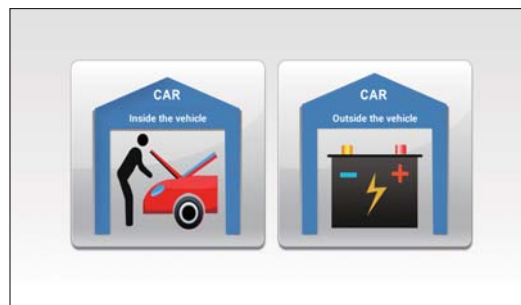

*Note: The sequences of inside the vehicle and outside the vehicle test are almost the same, but under inside the vehicle condition, all loads in vehicles must be powered off for getting an exact test value.

1. Firstly, the system detects whether floating electricity exists or not before testing. If yes, turn on the headlamp to remove it. Otherwise, the system starts test program directly.
2. Tap [Inside the vehicle], the system starts detecting floating electricity automatically. If floating electricity is detected, it will prompt you to turn on the headlamp.
3. Follow the on-screen instructions to turn on headlamp, the system starts removing floating electricity.
4. Once the floating electricity is removed, a prompt message box "The floating electricity has been removed, please turn off the headlamp to continue the testing" will appear on the screen.
5. Follow the on-screen instructions to turn off the headlamp and tap [OK], the system will continue the testing. Tap , it will enter testing standard selection screen.

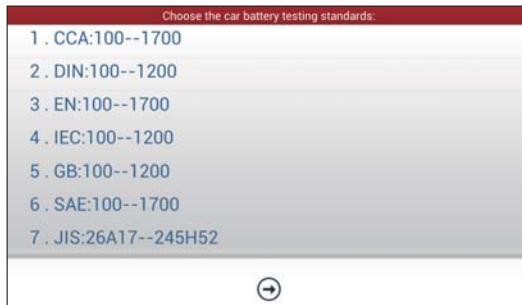

6. Select a testing standard except for JIS and tap  to enter the following figure. Users can adjust capacity size by tapping on < or >

or by dragging the slider on the bar.



If JIS is selected, tap , the system will enter Select testing capacity screen. Users can select corresponding standard capacity value according to battery model marked on battery.

7. Tap  and the testing result will appear on the following screen.



: Tap it to perform the charging system and starting system test.

: Tap to test it again.

[⊖]: Tap it to reset the test.

2. Charging system and starting system test

While performing this test, the battery's charging voltage value and starting voltage can be obtained in case of engine starting and accelerating. Based on the data, the system will judge whether battery's charging and actuation status is normal or not.

Tap  in BT-4, a dialog box will pop up.

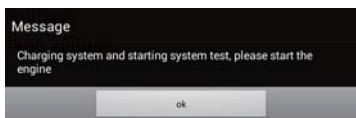

After detecting engine starting, follow the instructions on the screen to increase the speed.

The system begins to receive test data information after acceleration was detected.

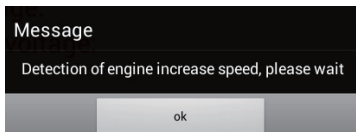

Tap [OK], test data will be shown on the screen.

*Note: It is unnecessary to perform charging system and start system test after finishing battery test, but battery test must be done before undergoing charging system and starting system test.

7.2.4.3 Outside the vehicle test

It only applies to battery test and detecting floating electricity will be ignored while performing battery test.

In BT-1, tap [Outside the vehicle] to select battery test standard.

The following operation steps are identical to Steps 6 ~ 7 in Chapter 7.2.4.2 Battery test. Please refer to it for details.

7.2.5 Precautions on battery test

For the purpose of getting accurate test results, unless otherwise special required, all loads need to be power off such as headlamp, engine etc. before testing battery.

The operating time required for charging system and actuation system test varies from person to person. If the engine does not start or accelerate within 30 seconds, the system will prompt you "receiving timeout" and return to the initial status.

Whether Engine is off or not has no influence on charging and actuation test result after increased speed is detected, but other loads need to be powered off.

The accuracy of battery voltage, charging voltage, start voltage is 0.01V in test results; CCA (Cold Cranking Amps) precision is 5CCA.

Generally, charging voltage value is greater than starting voltage.

Charging voltage range is as follows: 13.8-14.5V for domestic vehicle; 13.3-15.5V for imported vehicles. The voltage varies with different car models, so you have to judge based on related vehicle models. In general, the DC voltage is stable, but it also varies with different revolution speed.

Starting voltage range: The value higher than 9.6V is regular, otherwise it is too low. Due to different situations, whether the starting voltage is higher or not does not mean the vehicles or batteries are faulty. For detailed faults, other special equipments are needed. To validate the accuracy of the value, the best method is to collect the signals of starting and charging voltage and observe it on an oscilloscope.

Generally, the voltage is lower than 11V for the bad cell battery, but it is possible that the battery is completely exhausted or has a serious

low capacity. In this case, just recharge your battery. Bad cell always happens when the loads on a stopping vehicle are turned on for a long time.

Please note that it is normal for quick detecting of "Increase speed" because it follows the theory of detecting "Increase speed": If the detected voltage is higher than the previous battery test voltage, the system will prompt you a message of "Engine has been speeded"

It has no influence on test result in the event that engine's output voltage or engine revolution is not very stable. No matter whether the vehicle is accelerated or not, the output voltage only differs within 0.2V.

While doing inside the vehicle test, Kelvin clip is always found to be in poor contact. To remain it in good contact, please shake it several times before testing. Take down the battery connector, and test it again, the value probably varies. The deviation may arise from battery connector.

Pay more attention to connect the clip. The battery poles connect with conductor, which makes the clip has a poor connection when testing battery. A tolerance of dozens of CCA occurs if the clip is out of position, or oil, dust attaches on the pole. The gear and main body of clip should be fully matched with battery poles.

*Notes:

1. Battery poles inside the vehicle are enveloped by connectors, which may produce some errors for test results. The tolerance results from the resistance of connectors. The greater the resistance value is, the greater the tolerance becomes. But generally, the tolerance does not affect the test conclusion.
 2. Testing the battery separately generates an exact test result. The battery box is a very useful auxiliary tool for quick test. If any problems were found, test it separately for getting an exact test result.
-

7.2 Battery Detection (V2.0, Optional)

7.2.1 Product Summary

Adopting the state-of-the-art conductance testing technology in the world, the vehicle battery diagnostic tool provides the excellent ability to test vehicle's battery status. In addition to battery health test, charging system and start system test also can be done.

It supports various battery standards and specifications, including CCA, DIN, IEC, EN, JIS, SAE and GB etc. It is specifically designed to help car owner, repair workshop, battery factory operate battery tester properly and determine whether the battery is normal or not.

7.2.1.1 Test Standard

Battery test aims to check starting plumbic acid storage batteries for vehicles, ship, boats and aviations, etc. It can test all kinds of batteries complying with CCA, DIN, JIS, EN, GB and SA standards. For detailed test standards, see the following table.

Standards	Full name	Test capacity range
CCA	Battery Council International	100 ~ 1700
DIN	Deutsche Industry Normen	100 ~ 1200
JIS	Japanese Industry Standard	26A17 ~ 245H52
EN	Europe Norm	100 ~ 1700
IEC	National Electrical Commission	100 ~ 1200
GB	Chinese National Standard	100 ~ 1200

SAE	Society of Automotive Engineers	100 ~ 1700
-----	---------------------------------	------------

7.2.1.2 Components & Controls

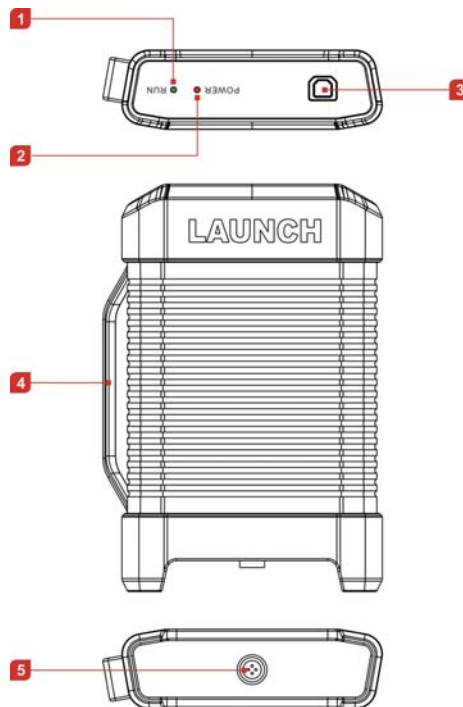

- 1. RUN LED** - if the GREEN LED is steady ON, it indicates the clips are well connected. If it keeps blinking, it indicates that the clips have poor contact.
- 2. POWER LED** - illuminates RED if the battery tester has been powered up.
- 3. Data I/O Port** - connects the battery tester to the diagnostic tool via data cable so that the signal can be displayed on the tool.
- 4. Handle**
- 5. Battery Connector** - connects the battery clamps battery to the vehicle's battery for battery test.

Technical Parameters

Working voltage	9 ~ 18V DC
Average working current	< 100mA
Working temperature	-20℃ - 50℃
Storage temperature	-30℃ - 70℃

7.2.1.3 Accessory Checklist



Battery Clamps Cable

(For connecting the battery test and the vehicle's battery)



Data Cable

(For connecting the battery tester and the diagnostic tool.)

7.2.1.4 Connections

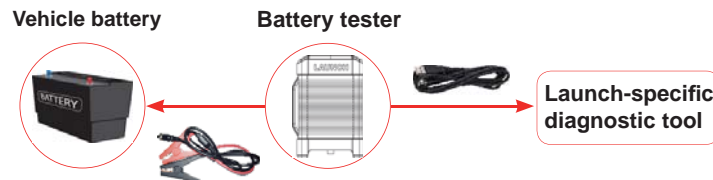

1. Connect one end of the data cable to the Data I/O port of the battery tester and the other end to the data I/O port of the diagnostic tool.
2. Before testing, connect one end of the battery clamps cable to the battery tester and the other end to vehicle's battery. First: RED to Positive (+) and then BLACK to Negative (-).

Notes:

1. Wait about 10s and begin to communicate since the battery tester needs to initialize after connection is complete, otherwise, communication may fail.
2. Do not perform any test until the clips and data cable are properly connected. To get more accurate test results, the clips must be connected to the positive and negative poles, NOT on the screws.
3. Pay more attention to connect the clip. The battery poles connect with conductor, which makes the clip has a poor connection when testing battery. A tolerance of dozens of CCA may occur if the clip is out of position, or oil, dust attaches on the pole. The gear and main body of clip should be fully matched with battery poles.
4. After test, please remove the BLACK clip first and then the RED one.

7.2.1.5 Main Menu



Main menu screen

It mainly includes the following function modules:

Battery health test

This function helps analyze the health status of the car battery, calculate the actual cold cranking capability of the battery, determine the aging degree of the battery, providing a reliable analysis basis for the test and maintenance of the battery. When the battery gets aged, it provides the ability to notify the user to replace battery.

Start system test

This function is designed to test and analyze the starting motor, detect the actual starting current and starting voltage of the starting motor, further determining whether the starting motor is normal.

Charging health test

This function mainly detects and analyzes the vehicle charging system, including generators, rectifiers, rectifier diodes, etc. Through this test, it can be known whether the generator output voltage is normal, whether the rectifier diode is normal, and whether the charging

current is normal.

Generate report

This option is used to save the reports after the battery health test, start system test and the charging health test are successfully performed.

Historical report

Manages the saved reports.

Product description

A general introduction of all function modules.

7.2.2 Battery Health Test

The battery health test is mainly to analyze the health status of the battery, calculate the actual cold cranking capability of the battery and the aging degree of the battery, which provides reliable analysis basis for the test and maintenance of the battery. When the battery is aging, the owner can be informed to replace the battery in advance.

Follow the steps below to proceed:

1. Tap "Battery Health Test" on the main menu screen.

 *Note: For getting accurate test result, please turn off all electrical components, including lights, radio and A/C etc. and pull out the vehicle start key before performing this test.

2. Select the correct battery type according to the battery name plate.



3. After selecting the battery type, the system detects whether floating electricity exists or not before testing (To skip this step, tap “Cancel floating electricity detection”).

 *Remarks: Floating electricity refers to the virtual power left by the car when it is started.

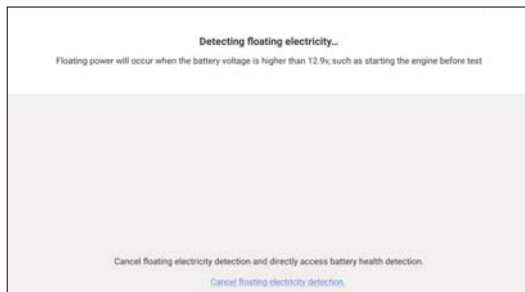

- A). If floating electricity is detected, the following screen will display:

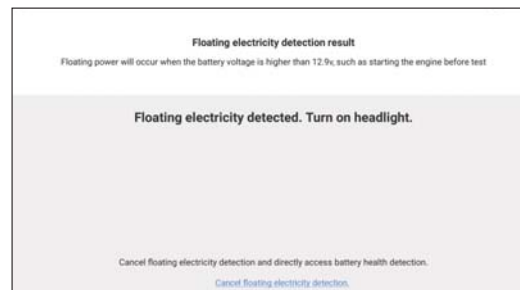

Follow the on-screen prompts to turn on the headlamp to remove it.

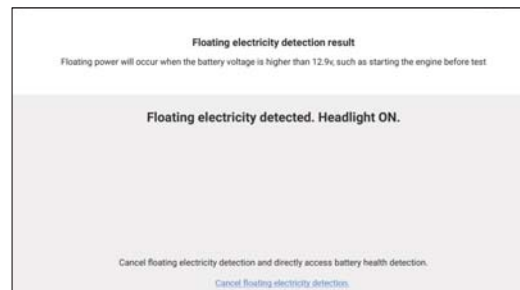

After the floating electricity is removed, the system will go to Step 4 directly.

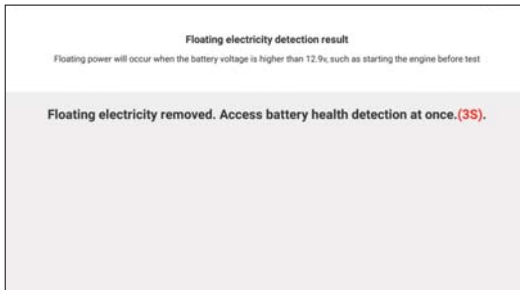

- B). If no floating electricity is detected, the system will go to the next step directly.
4. Select the desired battery testing standard and capacity.

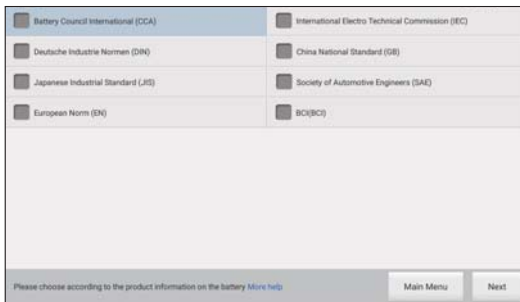

- A). If JIS is selected, directly choose the corresponding standard capacity value according to battery model marked on battery.

 *Remarks: Tap "Tips about JIS(Japanese Industrial Standard) batteries" to view more detailed information about JIS batteries.

26A17	26A19	30A19	34A19	26B17	28B17
28B19	34B17	34B19	36B20	38B19	38B20
40B19	42B19	44B19	44B20	46B24	50B24
58B24	60B24	68B24	32C24	48C26	50C20
55D23	55D26	60D23	65D26	65D31	70D23
75D23	75D26	75D31	80D23	80D26	85D23
85D26	90D26	95D31	105D31	110D26	115D31
95E41	100E41	105E41	110E41	115E41	120E41
130E41	115F51	130F51	145F51	150F51	170F51
145G51	155G51	165G51	180G51	195G51	160H52

Tip about JIS (Japanese Industrial Standard) batteries

Previous Next

JIS battery capacity selection screen

- B). If selecting a testing standard other than JIS, users can adjust capacity size by tapping on < or > or by dragging the slider on the bar.

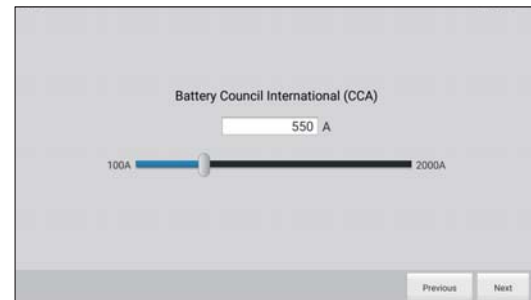

Other battery capacity selection screen

5. After setting, tap "Next". A screen displaying the test result and battery state will appear.



Where the **SOC** and **SOH** indicates the **State of Charge** and **State of Health** respectively.

There are mainly 5 states as follows:

No.	States	Descriptions
1	Good battery	Indicates the battery is normal.
2	Replace battery	Indicates that the battery is aged or becomes rejected, or battery life cycle approaches to be exhausted. In this case, battery voltage appears to be normal, but battery itself is not well, i.e. battery polarity board has been completely vulcanized or aged. Please replace battery immediately.
3	Good-recharge	The tested battery is good itself, but has a low voltage. Please recharge it before use.

4	Charge-retest	It is better for a few batteries to be fully charged before testing in order to avoid judging in error under special conditions.
5	Bad cell	Indicates one of the battery cells is bad and can not work normally, but for which one is bad, it can't be verified. In this case, battery voltage is generally lower than 11V, mainly resulting from internal circuitry damage, such as short circuit, open circuit, dummy weld etc. If the voltage is lower than 11V for the bad cell battery, it is possible that the battery is completely exhausted or has a serious low capacity. In this case, just recharge your battery. Bad cell always happens when the loads on a stopping vehicle are turned on for a long time.

7.2.3 Start System Test

This function is designed to test and analyze the starting motor. Through testing the actual required cranking current and voltage of the starting motor, it can be found out that the whether the starting motor is normal or not.

The starting motor is not normal, which may be caused by the following reasons: the malfunctioning of the lubrication system increases the starting load torque; the rotor friction of the starting motor causes the starting motor to increase its friction.

 *Note: It is unnecessary to perform this test after finishing battery health test, but battery test must be done before undergoing this test.

Follow the steps below to proceed:

1. Tap "Start System Test" on the battery main menu, the following operation tips will pop up on the screen.

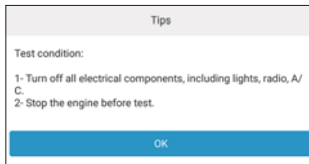

2. Turn off all electrical components, including lights, radio and A/C etc. and stop the engine before test, tap "OK" to confirm.



3. Follow the on-screen prompts to start the engine. After the startup test is completed, the system will display the start time and starting voltage.



 *Remarks: Floating electricity refers to the virtual power left by the car when it is started.

7.2.4 Charging Health Test

This function mainly detects and analyzes the vehicle charging system, including generators, rectifiers, rectifier diodes, etc. Through this test, it can be known whether the output voltage is the generator normal, the rectifier diode works properly, and the charging current is normal.

Suppose one of the above mentioned parts is not normal, it will lead to overcharge or undercharge of the battery, thus the battery will be rapidly damaged and also greatly shorten the service life of other loaded electrical appliances.

 *Notes:

- Please start the engine before test.
- It is unnecessary to perform this test after finishing battery health test, but battery test must be done before undergoing this test.

Follow the steps below to proceed:

1. Tap "Charging Health Test" on the battery main menu, the following operation tips will pop up on the screen.



2. Start the engine and tap "OK" to charge the battery.

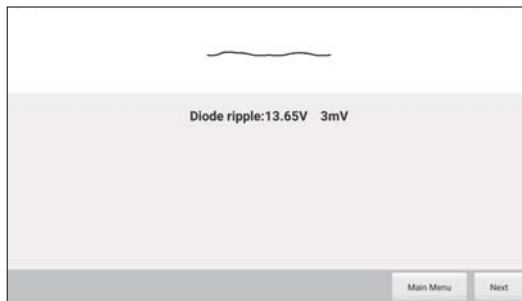

3. After detecting the charging voltage and diode ripple, tap "Next" to go to the next step.

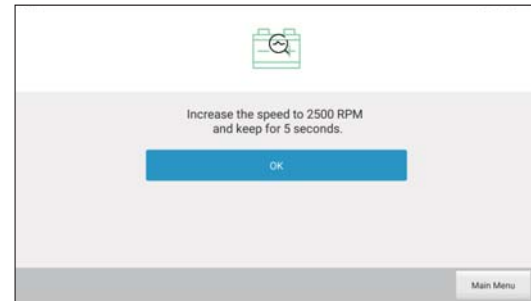

4. Follow the prompts on the screen to increase the speed to 2500 RPM and keep for 5 seconds. Tap "OK", the screen will display the test result.

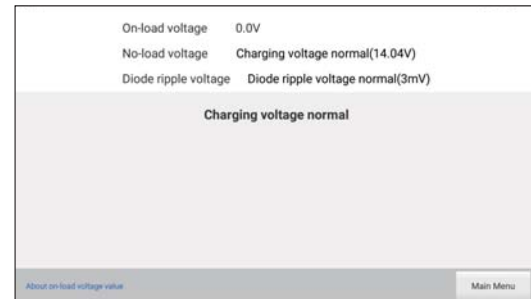

*Notes:

- On-load voltage refers to the charging voltage when there is a load. It evaluates the on-load capacity of the generator. When different auto parts are opened, the load voltage will be generated. The on-load voltage will greatly vary depending on the auto parts being opened.
- The operating time required for charging health test varies from person to person. If the engine does not start or accelerate within 30 seconds, the system will prompt you "receiving timeout" and return to the initial status.
- Whether Engine is off or not has no influence on charging health test result after increased speed is detected, but other loads need to be powered off.

7.2.5 Reports

7.2.5.1 Generate Reports

This option is used to save the reports after the battery health test, start system test and the charging health test are successfully performed.

Follow the steps below to proceed:

1. Tap "Generate Report" on the battery main menu, the system will detect which tests are made before. If the test is successfully done, it will be selected by default. If you do not plan to generate a report for this test, just tap it to deselect it.

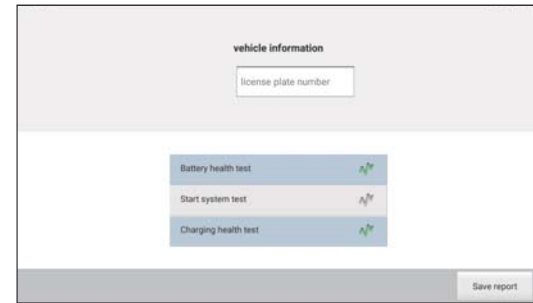

2. Tap the input box below the vehicle information, a virtual keyboard will pop up on the screen. Use the keyboard to enter the license plate.
3. After inputting, tap "Save report" to enter the report details page.

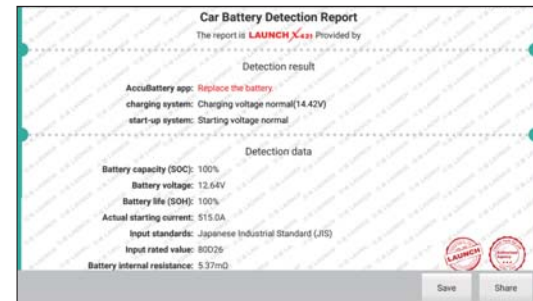

4. Tap "Save" to save it. The saved report will be stored in the "Historical Reports".
To share the report to the car owner, tap "Share" and the QR code

will pop up on the screen. Scan the QR code on the screen with smart phone to view the report details.

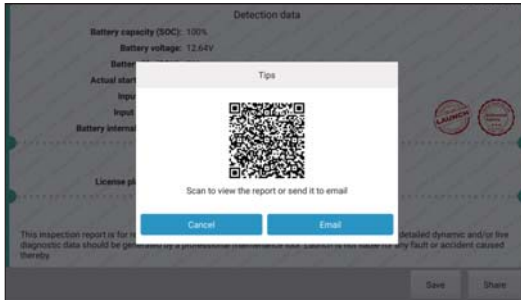

Alternatively, user can also share the report to the owner via Email by tapping the "Email" button on the screen.

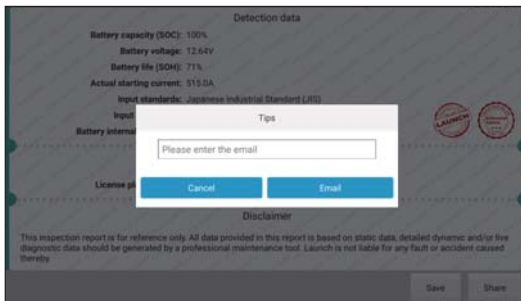

Enter the Email address, tap "Email" to send it.

7.2.5.2 Historical Reports

This function allows users to view or delete historical reports.



Tap the desired report to view its details.

To delete certain report, select it and then tap "Delete record".

7.3 Oscilloscope (Optional)

7.3.1 Introduction

The Scopebox is an optional add-on module of this tablet, including automotive oscilloscope and automotive ignition waveform.

Automotive oscilloscope can make the auto repair technician quickly judge the faults on automotive electronic equipment and wiring, and the oscilloscope sweep speed is far greater than the signal frequency of such vehicles, usually 5-10 times of the measured signal. The automotive oscilloscope not only can quickly acquire the circuit signal, but also can slowly display the waveform to observe and analyze. It can also record and store the tested signal waveform which can be recalled to observe for the fast signal, having great convenience to failure analysis. Either high-speed signal (e.g.: Injection nozzle, intermittent fault signal) or the slow-speed signal (e.g. the throttle position change and the oxygen sensor signal) can be observed through automotive oscilloscope in an appropriate waveform.

The electronic signal can be compared and judged via measuring five parameters indexes. The five parameters are the amplitude (the maximum voltage of signal), the frequency (the cycle time of signal), the shape (the appearance of signal), the pulse width (the duty cycle or the time range of signal), and the array (the repetition characteristic of signal), which can be tested, displayed, saved by the automotive oscilloscope. Via the waveform analysis can further detect the circuit fault on sensors, actuators, circuits, and electronic control units, etc.

7.3.2 Structure & Accessories

7.3.2.1 Scopebox structure



Fig. 7-20 Scopebox Structure Diagram



Below describes the ports and indicators for the Scopebox.





No.	Name	Descriptions
1	Fixed signal generator	Generate a square signal with fixed 1K frequency.
2	CH1	Channel 1
3	CH3	Channel 2
4	CH3	Channel 3
5	CH4	Channel 4

6	External trigger	External trigger signal (*It only applies if the Scopebox failed to trigger the signal itself.)
7	B-shaped data I/O port	Connect to the diagnostic tool via data cable so that the signal can be displayed on the tool.
8	Power interface	To provide power to it via the power adapter or battery clamps cable.
9	Communication indicator	It blinks in process of data communication.
10	Running LED	It remains steady green after the Scopebox is running.
11	Power LED	It keeps solid red after the Scopebox is powered on.



7.3.2.2 Scopebox accessories

The Scopebox includes the auto test leads, secondary pickup cable for 4-channel oscilloscope, crocodile clips for 4-channel oscilloscope, etc. See the packing list attached to the product for the detailed accessories.

No.	Name	Description
1	BNC to 4mm Test Leads	 <p>Test lead of a male BNC connector to (2) 4mm connectors. It is a kind of special line for assisting automobile Scopebox to test various types of signals. 4mm connectors are coded in two colors: black (earth wire) and red (positive pole which should be connected with the 6-way Breakout Leads). Moreover, it can also work with the 20:1 Attenuator.</p>
2	6-way Breakout Leads	 <p>Each lead has 6 blades wired to 6 sockets, allowing you to insert it between a plug and socket pair, other ends are 6 (4 mm) sockets which can be connected to the BNC to 4mm Test Lead.</p> <p>With these 6-way leads, you will be able to test most of the sensors and actuators on all makes and models of vehicle, including MAP, temperature, throttle position and airflow sensors, fuel pumps, primary ignition circuits and fuel injectors.</p>

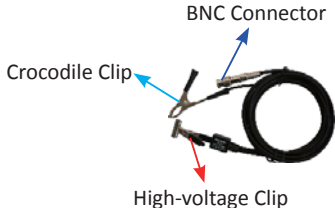
3	Data Cable	 <p>Connects the Scopebox and diagnostic tool so that the sampled signal can be displayed on the diagnostic tool.</p>
4	Power adapter	 <p>To supply power to the Scopebox through connection to AC outlet.</p>
5	Battery clamps cable	 <p>To supply power to the Scopebox through connection to vehicle's battery.</p>
6	20:1 Attenuator	 <p>It allows the Scopebox to measure fuel injector and primary ignition waveforms. *Note: Please note this attenuator should be not used for any high voltage measurements other than fuel injectors and primary ignition.</p>

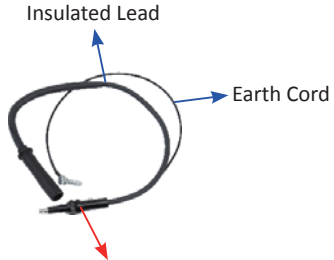
7	Secondary ignition pick-up	 <p>This ignition pick-up is applied in the following situations: Secondary-distributor ignition analysis, Secondary-simultaneous ignition analysis and Secondary-direct ignition analysis.</p> <p>It has three ends: BNC connector (for connecting to CH1/CH2/CH3/CH4), crocodile clip (for Grounding) and high-voltage clip (for connecting high-voltage line), near which has an attenuator equipped for high-pressure attenuation to prevent the Scopebox from being impacted.</p> <p>*Notes:</p> <ol style="list-style-type: none"> 1). The high voltage clip should be clamped on the insulated lead (COP Extension Cord, see Item 8) instead of on the spark plug to prevent breakdown and electric shock. 2). Please try to keep an instance of 2 inch from other high-voltage line to avoid the interference.
---	----------------------------	---

8	COP (Coil-on-Plug) Extension Cord	 <p>Coil-on-Plug extension cord (including earth cord) allows you to take accurate secondary ignition measurements on secondary-direct (Coil-on-Plug) ignition systems. It can be applied in the condition that there are no, or limited access to any spark plug leads.</p>
9	Multimeter probes	
10	Crocodile clips	 <p>Designed to connect the bare terminals or leads.</p>

11	Back Probe Pins Suite	 <p>They are mainly used for piercing the insulation of wires to allow for automotive electrical measurements without causing damage to the wires. Additionally they can be used as pin-tip probes while working with small circuit boards.</p>
----	-----------------------	--

7.3.3 Connection & Initial Use

7.3.3.1 Probe Compensation

Perform this function to match the characteristics of the probe(optional) and the channel input. The probe that has not been compensated may cause measurement tolerance or error.

1. Set the switch to "X10" (the default is X1) on the probe and connect it to the any Channel of the Scopebox.
2. Follow Steps 1-2 in Item 2 "Connection" mentioned below to connect the Scopebox and diagnostic tool. Launch the App and open "Scope" to run it.
3. From the "Vertical Setting" menu, select the corresponding channel and set the Probe attenuation to 1:10.
4. Attach the probe tip to the Probe Compensator and the ground nip of the reference lead to the ground connector. When using the probe hook-tip, insert the tip onto the probe compensator firmly to ensure a proper connection.

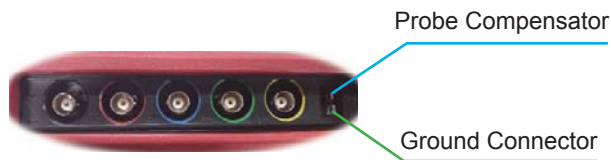

- Tap the **AUTO** button located on the bottom of the screen, a square wave (approximately 1kHzm 2V peak-to-peak) will be displayed within several seconds.

*Note: The above steps also can be applied to check whether the signal input/output of other Channels are normal or not.

Check the shape of the displayed waveform to determine whether the probe is correctly compensated.

Correctly Compensated		
Over Compensated		*Note: If necessary, use a non-metallic tool to adjust the trimmer capacitor of the probe for the fattest square wave being displayed on the Scopebox.
Under Compensated		

⚠ WARNING To avoid electric shock while using the probe, make sure the insulated cable is perfect, and do not touch the metallic portions of the probe head while it is connected with a high-voltage source.

7.3.3.2 Connection

For different applications, the connection methods may vary.

- Power the Scopebox on: Power is provided to the Scopebox in either of the following ways:
 - Power adapter:* Insert one end of the power adapter into the Power interface of the Scopebox, and the other end to the AC outlet.
 - Battery clamps cable:* Plug one end of the power adapter into the Power interface of the Scopebox, and then clamp the other two terminals to the vehicle's battery (Red to +, and Black to -) respectively.
- Connect the B-shaped terminal of the data cable to the Scopebox Data I/O port, and the other end to the Data I/O port of the diagnostic tool.
 - While testing sensors or actuators,
 - Connect the BNC connector of the BNC to 4mm test lead to the CH1/CH2/CH3/CH4, and plug the black (GND) and red (SIGNAL) 4mm connectors into the Black (GND) and other color (SIGNAL) banana sockets of the 6-way breakout leads respectively.

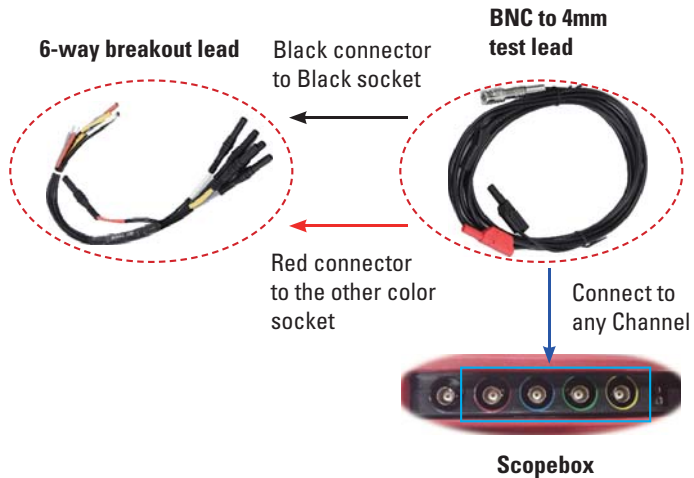

4. Connect the black terminal and signal wire (its other end connected to the red 4mm connector) of the 6-way breakout lead to the GND and signal terminal of the vehicle sensor.

B. While testing Secondary-distributor ignition analysis/Secondary-simultaneous ignition analysis.

3. Connect the BNC connector of the secondary ignition pick-up to any channel of the Scopebox, and clamp the crocodile clips and high-voltage clips onto the vehicle ground and high-voltage line respectively.

The connection is as follows:

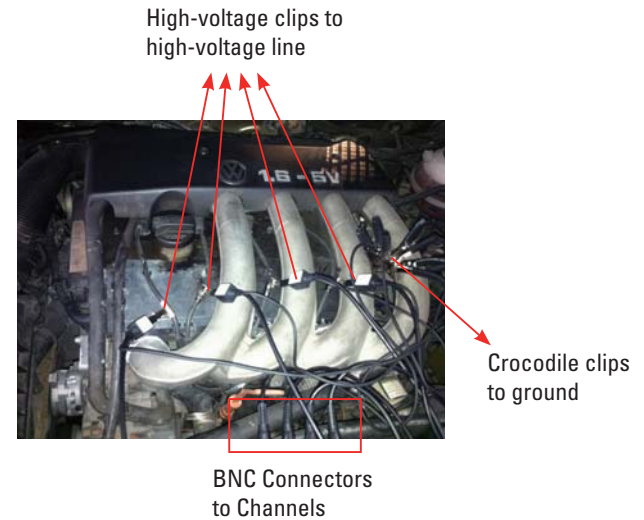

For detailed operations, please refer to Chapter 7.4.

C. While testing Secondary-direct ignition analysis.

3. *When the high-voltage wire is exposed*, plug the BNC end of secondary ignition pickup into CH1/CH2/CH3/CH4 channel of Scopebox, then connect the high-voltage clip to high-voltage line, and crocodile clips to ground.
4. *If no high-voltage wire is exposed*, dismantle ignition coil of tested cylinder. Connect one end of the COP extension cord to the ignition coil which should be grounded via COP earth cord, and insert the other end into the cylinder to joint with spark plug. Then plug the BNC end of secondary ignition pickup into CH1/CH2/CH3/CH4 channel of Scopebox, and then connect the high-voltage clip to

high-voltage line, and crocodile clips to ground.

The connection is as follows:

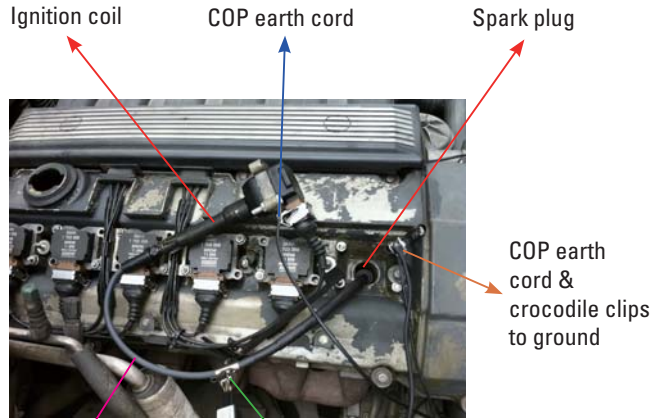

COP extension cord The high-voltage clips to the insulated lead of the COP extension cord





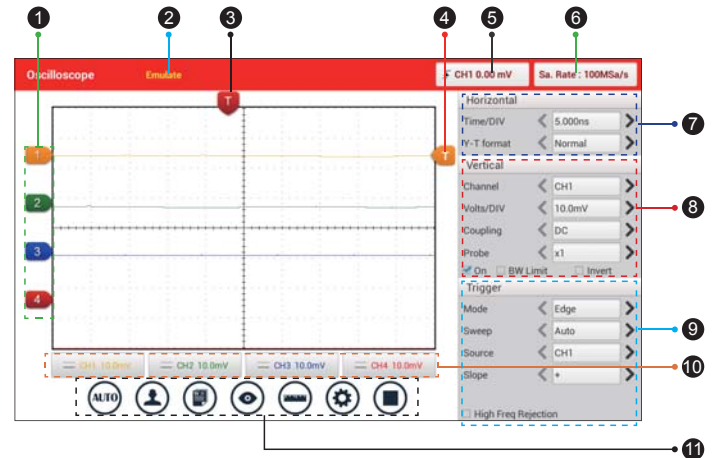

For detailed operations, please refer to Chapter 7.4.

7.3.3.3 Initial interface introduction

Below displays the initial interface of the Scopebox.



1	Displays the CH1/CH2/CH3/CH4 information: Readout shows the coupling and vertical scale factors of the channels. A “B” icon indicates that the channel is bandwidth limited.
2	Working mode
3	Horizontal trigger position marker
4	Edge trigger level marker
5	Displays the trigger information, including the edge trigger slope, source and level.
6	Sample rate

7	Horizontal Settings Panel: Controls the time base.
8	Vertical Settings Panel: Controls the amplitude of the displayed signal. User can change the volt/div, coupling and probe attenuation of the CH1/CH2/CH3/CH4.
9	Trigger Settings Panel: Controls the start event of the sweep.
10	Channel Selection Button
11	<p>Function Menu</p> <p> [Auto]: It indicates auto trigger setting.</p> <p> [Ref]: There are expert reference and base reference available. Expert reference enables you to recall your customized expert database, whereas base reference provides automatic pre-setting function of specialized sensors.</p> <p> [File]: Provides save snapshot, snapshot manager, waveform record and waveform replay.</p> <p> [View]: Calibration and display settings are available.</p> <p> [Measure]: Includes signal source measurement, horizontal measurement, vertical measurement and clear measurement.</p> <p> [Settings]: Shows/hides the parameter settings area including horizontal settings, vertical settings and trigger settings.</p> <p> [Start/Stop]: Starts/stops collecting waveforms.</p>

7.3.4 Operations

7.3.4.1 Channel selection and attributes setting

<1> Channel selection

There are two ways available for channel selection:

- Select from the channel tab shown at the bottom of the waveform display area
- Select from Vertical settings

*Note: For better comparison and identification, each channel and waveform are marked in different colors.



<2> Channel attributes & trigger setting

Channel attributes can be set via horizontal settings and vertical settings.

Horizontal Settings

User can make some settings directly by tapping < or > next to options.



Time/DIV: Horizontal scale. If the waveform acquisition is stopped

(using the  button), the Time/DIV selector expands or compresses the waveform.

Y-T format: The conventional oscilloscope display format. It shows the voltage of a waveform record (on the vertical axis) as it varies over time (on the horizontal axis).

Vertical Settings

The trigger determines when the Scopebox starts to acquire data and display a waveform. When a trigger is set up properly, it can convert unstable displays or blank screens into meaningful waveforms.

When the Scopebox starts to acquire a waveform, it collects enough data so that it can draw the waveform to the left of the trigger point. The Scopebox continues to acquire data while waiting for the trigger condition to occur. After it detects a trigger, the Scopebox continues to acquire enough data so that it can draw the waveform to the right of the trigger point.

User can make some settings directly by tapping < or > next to options.



Channel: To select the channel source.

Volts/DIV: It is defined as “Volts/Division” and mainly used to change the resolution.

Coupling: Trigger coupling determines what part of the signal passes to the trigger circuit. AC, DC and Ground are included:

- AC: Blocks the DC component of the input signal.

- DC: Passes both AC and DC components of the input signal.
- Ground: Disconnects the input signal.

Probe: When using a probe, the Scopebox allows you to select the attenuation factor for the probe. The attenuation factor changes the vertical scaling of the Scopebox so that the measurement results reflect the actual voltage levels at the probe tip.

BW Limit

- ON: Limits the channel bandwidth to 20MHz to reduce display noise.
- OFF: Get full bandwidth.

Invert

- ON: Invert the selected wave.
- OFF: Restore to the original display of the waveform.

Trigger setting

Trigger indicates that when certain waveform meets the conditions that are predefined according to the requirements, the Scopebox acquires the waveform and its adjacent section, and then displays it on the screen.

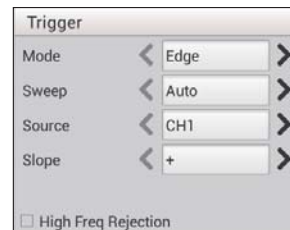

- 1) If **Edge** trigger is selected (An edge trigger determines whether the Scopebox finds the trigger point on the rising or the falling edge of a signal.):

Sweep: The sweep mode determines how the Scopebox behaves in the absence of a trigger event. The Scopebox provides three trigger modes: Auto, Normal, and Single.

- **Auto:** It allows the Scopebox to acquire waveforms even when it does not detect a trigger condition. If no trigger condition occurs while the Scopebox is waiting for a specific period, it will force itself to trigger.

When forcing invalid triggers, the Scopebox can not synchronize the waveform, and then waveform seems to roll across the display. If valid triggers occur, the display becomes stable on the screen.

- **Normal:** This mode allows the Scopebox to acquire a waveform only when it is triggered. If no trigger occurs, the Scopebox keeps waiting, and the previous waveform, if any, will remain on the display.
- **Single:** In this mode, it only acquires the waveform that generates for the first time the trigger conditions are met, and then stops after finishing capture.

Source: Select which channel as trigger signal.

Slope:

- + : Trigger on rising edge
- - : Trigger on falling edge

High Freq Rejection: Reject high frequency signals when selected.

2) If **Pulse Width** trigger is selected (Pulse trigger occurs according to the width of pulse. The abnormal signals can be detected through setting up the pulse width condition):

Sweep: The sweep mode determines how the Scopebox behaves in the absence of a trigger event. The Scopebox provides three trigger modes: Auto, Normal, and Single.

- **Auto:** It allows the Scopebox to acquire waveforms even when it

does not detect a trigger condition. If no trigger condition occurs while the Scopebox is waiting for a specific period, it will force itself to trigger.

When forcing invalid triggers, the Scopebox can not synchronize the waveform, and then waveform seems to roll across the display. If valid triggers occur, the display becomes stable on the screen.

- **Normal:** This mode allows the Scopebox to acquire a waveform only when it is triggered. If no trigger occurs, the Scopebox keeps waiting, and the previous waveform, if any, will remain on the display.
- **Single:** In this mode, it only acquires the waveform that generates for the first time the trigger conditions are met, and then stops after finishing capture.

Source: Select which channel as trigger signal.

Condition: To select pulse condition.

Pulse Width: Set required pulse width.

High Freq Rejection: Reject high frequency signals when selected.

7.3.4.2 Auto

The Scopebox has an Auto feature that sets up the Scopebox automatically to display the input signal in a best fit.

Tap , the Scopebox may change the current settings to display the signal. It automatically adjusts the vertical and horizontal scaling, as well as the trigger coupling, position, slope, level and mode settings.

7.3.4.3 View Settings

<1> Calibration

This option adjusts the Scopebox's internal circuitry to get the best accuracy. Use this function to calibrate the Scopebox's vertical and horizontal systems.

Tap  and then tap [Calibration], a dialog box similar to the following figure will appear.

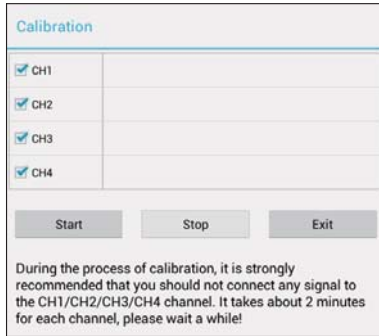

Check the box before the channel to select it. To deselect it, just uncheck it. After choosing the desired channel(s), tap [Start] to start calibration and [Start] button will be temporarily invalid during calibrating. Tap [Stop] to stop calibrating. Once it becomes active, it indicates calibration has completed.

*Note: In process of calibration, make sure CH1/CH2/CH3/CH4 has no signal input. Moreover, calibration may take several minutes and please be patient to wait.

<2> REF settings

Reference waveforms are saved waveforms to be selected for display. The reference function will be available after saving the selected waveform to non-volatile memory.

Tap  and then [REF] to enter the REF setting screen.



Tap < or > to select the desired reference value for time/DIV and volts/DIV. To show or hide the REF, just check/uncheck the box before On/Off.

<3> Display settings

Tap  and then [Display settings] to enter the setting screen.

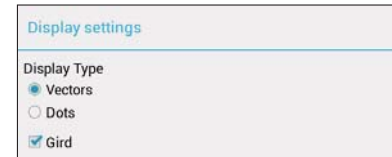

Select "Vectors" or "Dots" to display waveforms as vectors or dots. Check / uncheck the box before Grid to turn on/off grid display.

7.3.4.4 Measure

<1> Channel source

Tap  and then [Source], a screen similar to the following will appear.



<2> Horizontal / Vertical measure

Horizontal Measure / Vertical Measure are used to measure voltage parameter and time parameter respectively. Drag A line upwards or downwards to control voltage. Move A line left or right to fine-tune timebase. A line is a solid line and B line is a dotted line.

Tap and then [Horizontal Measure], a screen similar to the following will appear.



*Note: If no desired channel is selected, the system will take the current source as the default channel.

<3> Clear measure

Tap and then [Clear Measure], the system will clear the measurement result on screen.

7.3.4.5 File management

<1> Save snapshot

While viewing sampling data, tap and then [Save Snapshot] to store the current screen.

<2> Snapshot manager

While viewing sampling data, tap and then [Snapshot Manager] to enter. View, delete and edit operations are supported.

<3> Record waveform

This function is used to record input waveforms that are acquired by the Scopebox at a specific period, and save it as waveform file which can be recalled in future.

It can be performed only when the Scopebox is collecting data in Normal mode.

Tap , then select [Record] from the pop-up menu to start recording.

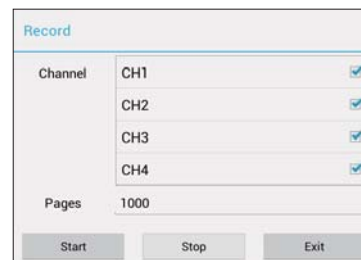

Tap [Start] to start recording with a minimum record length of 10



frames, and [Stop] to stop recording. While recording, the recorded pages will be shown on the screen.

<4> Load waveform for playback

The Import function enables you to import the stored waveform file for playback and review. During replaying, the Scopebox stops collecting data automatically.

Tap , then select [Waveform replay] from the pop-up menu to enter:



Select the file first, and then tap  to open the waveform file. Tap  to starting the playback and tap  to stop it.

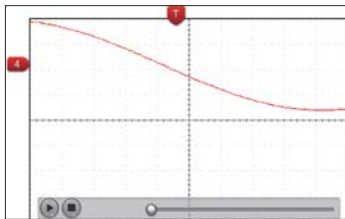

To delete the waveform file, tap .

Tap  to return to the previous screen.

7.3.4.6 Expert reference

<1> Expert Reference

By default, it appears blank. As a matter of fact, Expert reference database is generated by doing the following:

1. Open and edit a snapshot;
2. Select “Joint the expert database” (refer to the following illustration), and then tap  to save the waveform being displayed on the screen as REF.



Tap  and then [Expert Reference] to enter, the following operation can be done:

: To load and recall the selected file.

: To delete the selected file.

: To edit the selected file.

<2> Base Reference

Preset waveforms of some sensors are available for your reference.



7.4 Ignition (Optional)

The ignition system is the system which has greatest impact on the performances of gasoline engine, as the statistical data shows that nearly half of the failures are caused by poor work of electrical system. And the performance tests of engine often start from the ignition system. Nowadays ignition system includes distributor and distributorless. Distributorless includes independent ignition and simultaneous ignition.

1. Distributor ignition system i.e. contact breaker with contact-controlled ignition system (commonly known as the platinum) and contact breaker with noncontact-controlled ignition system combined with magnet, hall components or infrared.
2. Independent ignition system: crankshaft sensor send out the ignition timing signal and cylinder identification signal so that the ignition system can send out ignition signal to specified cylinder in specified time, each cylinder has its independent ignition coil.
3. Simultaneous ignition system: two cylinders share one ignition coil, when two cylinder pistons reach top dead center at the same time (one is compression, another is the exhaust), two spark plugs will be ignited at the same time, at this time, the ignition for the former cylinder is in high-pressure low temperature gas mixture, the ignition is valid, while for the latter one is in low-pressure high temperature exhaust gas, the ignition is invalid.

The tablet can test and analyze the secondary signal for various engine ignition systems.

The Ignition module utilizes the same hardware device as the Scope module.

7.4.1 Secondary-distributor ignition analysis

The following connection should be made before performing it:

- Power the Scopebox on: Power is provided to the Scopebox in either of the following ways:
 - Power adapter:** Insert one end of the power adapter into the Power interface of the Scopebox, and the other end to the AC outlet.
 - Battery clamps cable:** Plug one end of the power adapter into the Power interface of the Scopebox, and then clamp the other two terminals to the vehicle's battery (Red to +, and Black to -) respectively.
- Connect the B-shaped terminal of the data cable to the Scopebox Data I/O port, and the other end to the Data I/O port of the diagnostic tool.
- Plug the BNC end of secondary ignition pickup into CH1/CH2/CH3/CH4 channel of the Scopebox, and connect the high-voltage clip to high-voltage line, and crocodile clips to ground.

*Tips: Common ignition sequence (the specific sequence is subject to the actual engine ignition sequence)

Four-stroke in-line four-cylinder: 1-2-4-3, or 1-3-4-2

Four-stroke in-line six-cylinder: 1-5-3-6-2-4, or 1-4-2-6-3-5

Four-stroke in-line eight-cylinder: 1-8-4-3-6-5-7-2

Five-cylinder: 1-2-4-5-3

V 6 engine: generally speaking, based on the person sitting on the driver cab, if the right side cylinder numbers on the right side, from the front to the back are as follows: 1, 3, 5; and the cylinder numbers on the left side, from the front to the back are as follows: 2, 4, 6; then the ignition sequence is: 1-4-5-2-3-6. If the cylinder numbers on the right side, from the front to the back are as follows: 2, 4, 6; and cylinder numbers on the left side, from the front to the back are as follows: 1, 3, 5; then the ignition sequence is: 1-6-5-4-3-2.

IA-1 below shows the normal ignition waveform of distributor ignition system, the upper one is the secondary waveform, and the lower one is the primary waveform.

The secondary waveform

A section is contact open period; B section is make contact period, which is the magnetizing field of ignition coil.

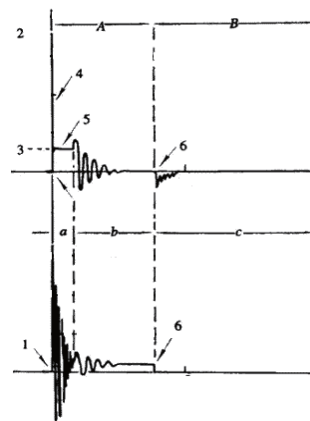

IA-1

- Contact break point: the primary circuit of ignition coil cut off, the secondary voltage was sensed and increased sharply
- Ignition voltage: secondary coil voltage overcome the damper of high voltage line, the contact breaker gap and the spark plug gap to release magnetizing energy, 1-2 section is the breakdown voltage
- Spark voltage: For the capacitor discharge voltage
- Ignition voltage pulse: For the charge and discharge sections
- Spark line: The inductance discharge process, i.e. the mutual

inductance voltage of ignition coil maintains the conduction of secondary circuit.

- 6) Contact point close the current flow into primary coil, the primary coil oscillates due to the mutual inductance.

Primary ignition waveform

Section a shows the voltage oscillation on the primary circuit due to the magnetic induction of spark in the duration;

Section b shows the damped oscillation generated by remaining magnetic field energy after the spark;

Section c shows the make contact magnetizing period of primary coil.

Seen from the waveform, the amplitudes of breaker contact closed angle, break angle and breakdown voltage and spark voltage are very clear, besides, the spark delay period and two oscillations can also be tested. For the ignition system without faults, compared with the whole cycle, the contact closed angle just 45%-50% (four-cylinder), 63%-70% (six-cylinder), or 64%-71% (eight-cylinder); the breakdown voltage is over 15kv; the spark voltage is about 9kV, the spark period is greater than 0.8ms. If these values or waveform are abnormal, it means there is fault or the system needs to be adjusted.

7.4.2 Secondary-simultaneous ignition analysis

The following connection should be made before performing this function:

1. Power the Scopebox on: Power is provided to the Scopebox in either of the following ways:
 - *Power adapter*: Insert one end of the power adapter into the Power interface of the Scopebox, and the other end to the AC outlet.
 - *Battery clamps cable*: Plug one end of the power adapter into the Power interface of the Scopebox, and then clamp the other

two terminals to the vehicle's battery (Red to +, and Black to -) respectively.

2. Connect the B-shaped terminal of the data cable to the Scopebox Data I/O port, and the other end to the Data I/O port of the diagnostic tool.
3. Plug the BNC end of secondary ignition pickup into CH1/CH2/CH3/CH4 channel of the Scopebox, and connect the high-voltage clip to high-voltage line, and crocodile clips to ground.

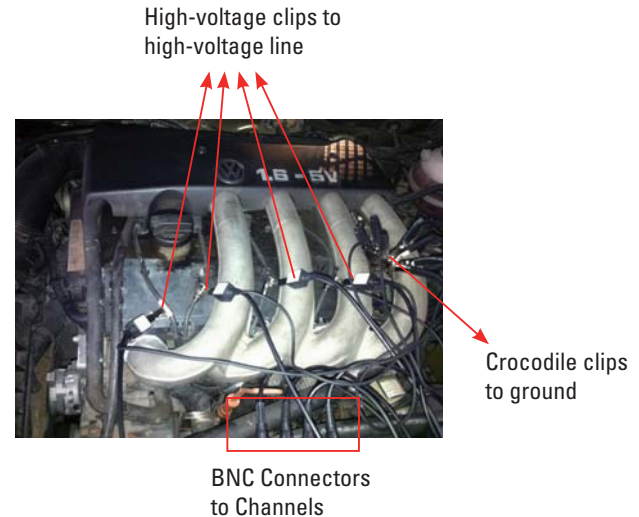

IA-2 below shows the valid and invalid ignition waveforms. Under the working status of valid ignition, the breakdown voltage and spark voltage are higher because the cylinder is filled with fresh combustible mixture gas, which has a lower ionization level and vice versa.

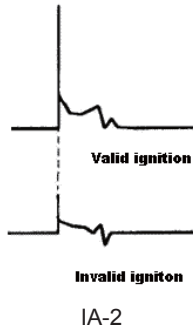

7.4.3 Secondary-direct ignition analysis

1. Power the Scopebox on: Power is provided to the Scopebox in either of the following ways:
 - *Power adapter:* Insert one end of the power adapter into the Power interface of the Scopebox, and the other end to the AC outlet.
 - *Battery clamps cable:* Plug one end of the power adapter into the Power interface of the Scopebox, and then clamp the other two terminals to the vehicle's battery (Red to +, and Black to -) respectively.
2. Connect the B-shaped terminal of the data cable to the Scopebox Data I/O port, and the other end to the Data I/O port of the diagnostic tool.
3. *When the high-voltage wire is exposed,* plug the BNC end of secondary ignition pickup into CH1/CH2/CH3/CH4 channel of Scopebox, then connect the high-voltage clip to high-voltage line, and crocodile clips to ground.
4. *If no high-voltage wire is exposed,* dismantle ignition coil of tested

cylinder. Connect one end of the COP extension cord to the ignition coil which should be grounded via COP earth cord, and insert the other end into the cylinder to joint with spark plug. Then plug the BNC end of secondary ignition pickup into CH1/CH2/CH3/CH4 channel of Scopebox, and then connect the high-voltage clip to high-voltage line, and crocodile clips to ground.

The connection is as follows:

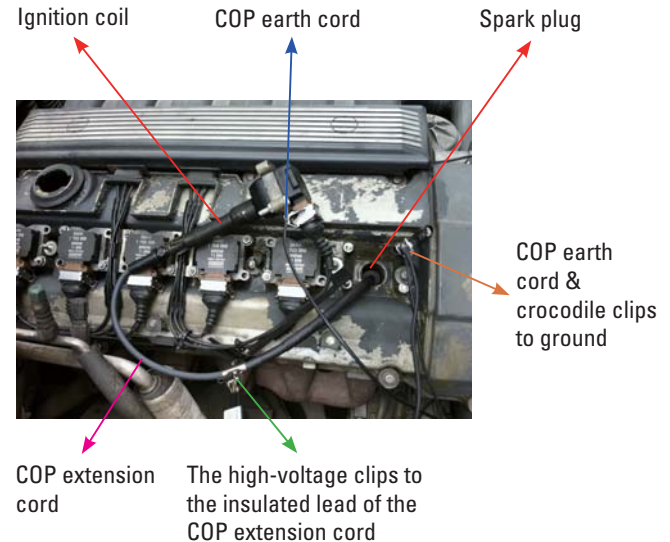

IA-3 shows the normal secondary (the upper one) and (the lower one) primary ignition waveform of direct ignition system. Because the on/off of primary circuit is not opening/closing of mechanical contact, but the conduction of transistor. The primary voltage has no obvious

oscillations within the duration, but the voltage increases during the magnetization process due to current limiting, and this change can cause corresponding fluctuations of secondary voltage line as a result of induction of ignition coil.

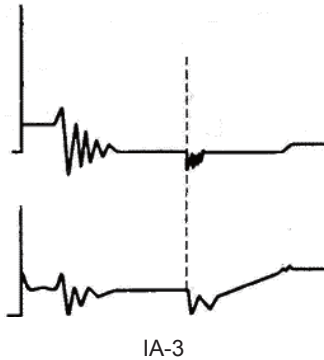

7.4.4 Waveform analysis mode

The ignition secondary single-cylinder waveform test is mainly used to:

- Analyze the ignition dwell angle of single cylinder.(ignition coil charging time)
- Analyze the capability of ignition coil and secondary high tension circuit (from ignition line to ignition voltage line).
- Find the improper mixture A/F ratio of single cylinder (from combustion line).
- Analyze the capability of capacitance (platinum or ignition system).
- Find the spark plug that causes misfire of the cylinder (from combustion line).

This test can provide very meaningful information about the combustion quality for each cylinder. If necessary, this test can also

be performed during driving. Since the secondary ignition waveform is significantly affected by different engines, fuel systems and ignition conditions, it is useful for detecting the faults of engine mechanical parts, fuel system components, and ignition system components. Different parts of the waveform can specify that some components and systems on the specific cylinder have faults. Refer to the instructions for various parts of waveform for the related component working status of specific waveform section.

Test methods and conditions:

Start the engine or drive the vehicle according to the driving performance fault or poor ignition, etc. Confirm the consistence of judgment standard (the amplitude, frequency, shape and pulse width, etc., for each cylinder), check the fault of the waveform for corresponding components.

Waveform results: observe the ignition coil at the beginning of charging, the relative consistent falling edge represents the dwell angle and ignition timing of each cylinder are precise.

Ignition line:

Observe the height consistence of flashover voltage. Too high flashover voltage (even out of the oscilloscope screen) represents a high resistance existed in the ignition secondary circuit (for example, open circuit, or damaged spark plug or high voltage line, or too large time gap on spark plug), while the too short sparking voltage represents the resistance of ignition secondary circuit is lower than normal value (due to pollutant and broken spark plug or the high voltage line of spark plug has electrical leakage, etc.).

Spark or combustion voltage:

Observe the consistence of spark or combustion voltage, as it represents the consistence of spark plug and the air-fuel ratio of each cylinder. In case that the mixing ratio is too lean, the combustion voltage will be lower than normal value.

Combustion line:

Observe the spark or the combustion line which shall be clean with few clutter, as lots of clutter indicates the cylinder has poor ignition due to ignite too early, damaged nozzle, pollutant spark plug, or other reasons. The duration of combustion line indicates the mixing ratio of the cylinder is abnormal lean or rich. Too long combustion line (usually greater than 2ms) represents the mixing ratio is rich, whereas too short of combustion line (usually less than 0.75ms) represents the mixing ratio is lean.

Ignition coil oscillation:

Observe at least two oscillation waveforms after the combustion line, which will be better if more than three oscillation waveforms, as it represents the ignition coil and capacitor (on Platinum or ignition system) are normal.

Primary voltage analysis

According to the faulty primary voltage waveform collected by the ignition analysis, the related components and mechanical equipment status of ignition system electrical circuit can be analyzed, which provides a reliable basis for the adjustment and maintenance of power circuit to avoid the blind demolition.

The waveform shown on Fig. IA-4, appears a lot of clutter on the contact break point, which is obviously caused by the serious erosion on contact break point. It can be verified via burnishing the contact or changing the circuit breaker.

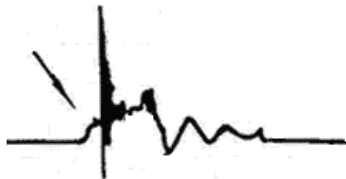

IA-4

For the primary voltage waveform shown on IA-5, the damped attenuation cycles obviously reduced on the spark period, the amplitude became lower, which is evidently caused by capacitor leakage.

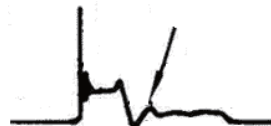

IA-5

The waveform on IA-6 shows the accidental pumping during contact closing period. The irregular beating is caused by insufficient spring force.



IA-6

The curve on IA-7 shows the contact angle is too small during the magnetizing period, which is caused by too large contact gap.



IA-7

A lot of clutter will be displayed on the horizontal section of primary waveform if contact has poor grounding, as shown below IA-8.

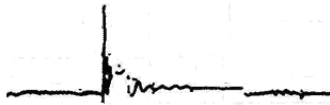

IA-8

IA-9 shows the fault of low-voltage waveform in electronic ignition system. The voltage does not rise during magnetizing, which indicates that the effect of limitation of the circuit failed and no components on distributorless ignition system can be adjusted. When this waveform is abnormal, you can only replace the ignition coils, igniter, ignition signal generator and cam position sensor, etc., one by one, to find out the faulty component or module.



IA-9

The secondary waveform is also affected by the spark plug, the combustion process, mixture gas composition, the engine thermal state of the ignition coil, etc., which is more complicated. The following lists a large number of measured secondary faulty waveform for reference. Since various factors lead to the failures, IA-10 just shows the major possible factors for the failures.



Secondary circuit resistance is too large



Oil or coke was attached in spark plug



Spark plug gap is too large or mixture gas is too lean



Injector of electronic fuel injection poor work



Spark plug overheated or valve guide leakage



Mixture ratio is too rich or spark plug leak electricity



Mixture ratio is too lean or cylinder pressure is too low



Distributor cover or distributor lead is matched un-tightly

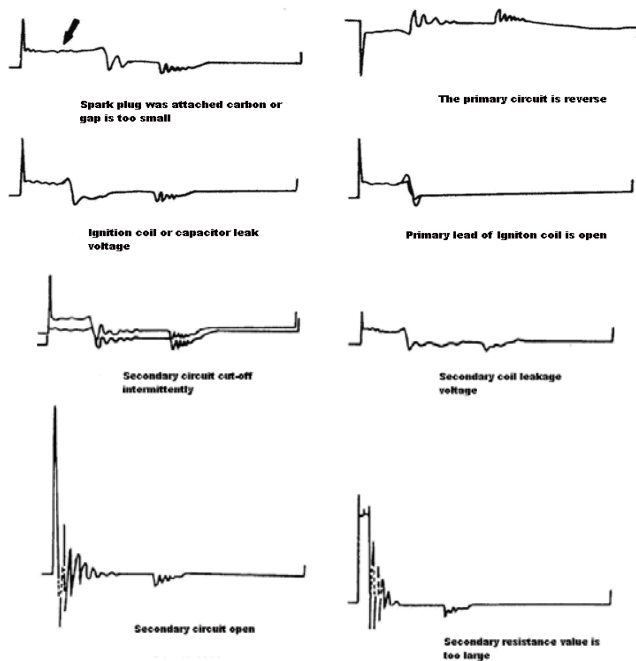

IA-10

7.5 Videoscope (Optional)

7.5.1 Introduction

Automotive videoscope is mainly applied to those unseen parts of engine, fuel tank, braking system.

While testing a vehicle system, engine is one of the main parts to be checked. To check if the internal of a engine is qualified or not or whether internal carbon deposit and damage exists in the engine or not, we can make full use of a videoscope to solve these questions.

The tablet provides an optional function of videoscope.

The videoscope is mainly composed of an inspection camera, flexible tube and data cable. The water-resistant camera lens with adjustable LED lights enables you to observe the parts that can not be seen in wet, dark, fluid soaked places. The included flexible tube is convenient for easy inspection and allows for access to hard-to-reach areas.

In addition, the captured pictures and videos also provide you intuitive data for easy analysis.

7.5.2 Components & controls



1 Snapshot button: To take a snapshot of the current view and save it on the tablet as an image.

2 Flexible tube: You can bend the neck to get in to hard-to-reach places and even if it is not straight, it can still give you pictures of what the camera is looking at (*Note: Do NOT force it too hard while bending the neck into strange shapes).

3 Dial for LED light brightness: There are 4 LED lights in the lens that act like a torch to illuminate dark spots where the camera can not see well. This dial allows you to adjust the light brightness.

4 Handle

5 Camera with 4 adjustable LED lights: The camera head is water-resistant and is where you can attach the useful optional accessories (magnet, mirror, hook) add-on.

6 Data cable: Connect it to the diagnostic tool for viewing what the camera captures.

7.5.3 Technical Parameters

Resolution	640 x 800 pixel (VGA)
Frame Rate	30fps (pictures/sec)
Image Sensor	1/12" CMOS
White Balance	Automatic
Exposure	Automatic
Light Source	4 adjustable LEDs
Power Supply	5V
Ambient temperature	0 to +65°C
Data Cable Length	Approx. 2000mm
Probe & Camera Length	1030mm
Probe Cable Length	830mm
Min. Bending Radius	50mm

Lens Diameter	7.0mm
Probe Tube Diameter	6.0mm
Viewable Angle	60°
Lens Focal Length	More than 50mm
Net Weight	Approx. 270g

7.5.4 Connections & Operations

1. Insert the data cable into the data I/O port of the diagnostic tool.
2. Bend the neck of the flexible tube as desired and extend the camera with adjustable LED lights to some unseen or unreachable parts of engine, hydraulic system, nozzles etc.
3. After connections are properly made, press the **[POWER]** button on the tablet to turn it on. Wait until the system enters the Home screen.
4. Tap the application to launch it. Switch to the "Toolbox" -> "Videoscope" to run it, and then the screen will display the scene captured from the videoscope camera.
5. Adjust it until the lens stops in the desired place, then use the **dial for LED light brightness** to adjust the brightness.
6. Press the **Snapshot** button on the videoscope to take a photo. Alternatively, you can also press the **Snapshot** button on the tablet to take photos.

To record a video, switch from Camera mode to Video mode and tap the **Record** button on the screen to start recording.

Images are captured in .jpg format and videos are recorded in .avi or

.mp4 format. All photographings and videos are saved in DCIM folder where users can browse and replay it.

8 Other Modules

8.1 Email

The function allows you to send and receive email.

*Note: Before sending or receiving email, you have to set up an email account. In addition, this function required a stable network connection.

1. On the Home screen, tap Other Modules -> Email.
2. Input the Email address, tap NEXT.
3. Choose the desired email account type.
4. Input the password, tap "Next".

*Note: If "Manual setup" is selected, please consult your email service provider for detailed parameter setting.

5. Follow the on-screen instructions to proceed until the system prompts you that the account setup has been finished.

8.2 Browser

This browser is a simple and convenient web browsing tool.

It can help you quickly and securely search for the content you need. It is powerful and can ensure that users can make the browser run quickly and stably when multiple pages are opened.

8.3 TeamViewer

TeamViewer is a simple, fast and secure remote control interface, which enables you to receive remote support from technician fellows, colleagues or friends by allowing them to control your tablet on their computer or TeamViewer software on the mobile device.

Computer and mobile devices that run TeamViewer are identified by a

globally unique ID. The first time the TeamViewer is launched, this ID is generated automatically based on the hardware characteristics and will not change later on.

8.3.1 TeamViewer QuickSupport

This app allows you to request a remote support from a partner.

Follow the steps below to proceed:

1. On the Home screen, tap Other modules -> TeamViewer QuickSupport. The TeamViewer interface displays and the device ID is generated and shown.

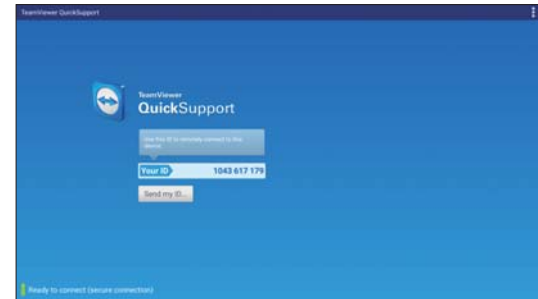

2. Your partner must install the TeamViewer full version program (if not installed, go to <http://www.teamviewer.com> to download it), and then start the software on his/her computer at the same time, in order to provide support and take control of your tablet remotely.
3. Provide your ID to the partner, and wait for him/her to send you a remote control request.
4. A dialog box asking for your confirmation to allow remote control on your tablet will appear.
5. Tap Allow to accept, or tap Deny to reject.

For more information, please refer to the associated TeamViewer documents.

8.3.2 TeamViewer

This app enables you to remotely control a partner's device.

1. On the Home screen, tap Other modules -> TeamViewer. The TeamViewer interface displays.

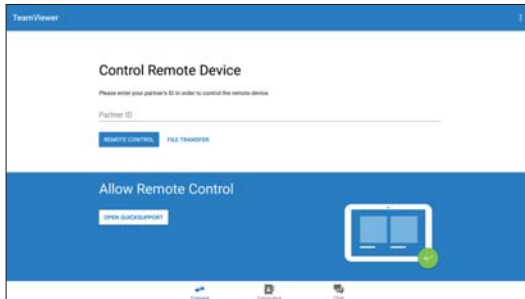

2. Your partner must install the TeamViewer QuickSupport program (if not installed, go to <http://www.teamviewer.com> to download it), and then start the software on his/her computer/mobile device at the same time, in order to control the partner's computer/mobile device remotely.
3. Input the partner's ID, tap "REMOTE CONTROL" to send a remote control request.
4. After the partner confirms to accept remote control from your tablet, the remote assistance is now starting.

8.4 Wireless Upgrade

An Over-the-Air (OTA) update is the wireless delivery of new operating

system, software or data to tablets and mobile phones. Wireless carriers have traditionally used over-the-air updates to deploy firmware and configure phones or tablets for use on their network. The initialization of a newly purchased tablet required an over-the-air update.

**Note: While performing OTA update, please make sure the tablet battery has at least 70% and DO NOT run any other programs during the update.*

1. On the Home screen, tap Other modules -> Wireless Upgrade.



2. Tap "Check for updates". Once a newer version is found, follow the on-screen instructions to download and install the update file.
3. Be patient to wait until the update is done.

8.5 Files

ES File Explorer is a file and application manager. You can access and create folders on the tablet without needing to connect it to a computer.

The app also features an application manager, task killer and download manager. Another excellent feature is support for cloud

storage accounts. This means you can download files directly to the folders you want without using a separate app.

The app has built-in ZIP and RAR sources, so you can access compressed files without unpacking them on your tool first.

For more information, please refer to the associated ES file explorer documents.

8.6 Gallery

This function allows you to take new pictures and manage the picture library (including screenshots).

8.7 Recording Master

It is an easy-to-use, free screen recorder app, allowing you to capture any area of your screen either as a screenshot or a screencast video file.

Appendix - FAQ

1. Communication error with vehicle ECU?

Please confirm:

1. Whether the VCI is properly connected.
2. Whether the vehicle ignition switch is ON.
3. If all checks are normal, send vehicle year, make, model and VIN number to us using Feedback feature.

2. Failed to enter into vehicle ECU system?

Please confirm:

1. Whether the vehicle is equipped with the system.
2. Whether the VCI is correctly connected.
3. Whether the vehicle ignition switch is ON.
4. If all checks are normal, send vehicle year, make, model and VIN number to us using Feedback feature.

3. Can I use any other power adaptor other than the included power adaptor to charge the tablet?

No. Please use only the included power adaptor to charge the tablet. We assume no responsibility for damage or loss resulting from the use of the any other adaptors.

4. How to save power?

- Please turn off the screen while the device keeps idle.
- Set a shorter standby time.
- Decrease the brightness of the screen.
- If WLAN connection is not required, please turn it off.

- Disable GPS function if GPS service is not in use.

5. How to reset the tablet?

*Warning: Resetting may cause data loss. Before doing so, please make sure important data and information has been backed up.

There are 2 methods available to reset the tablet:

Method 1

1. Ensure the tablet is in ON mode.
2. Select "Tablet Setting" on the Home screen.
3. Select "Backup & reset".
4. Tap "Factory data reset".
5. Tap "RESET TABLET" to confirm.

Method 2

1. Ensure the tablet is in OFF mode.
2. Hold and press VOLUME - key and POWER key until the tablet enters system boot mode.
3. Use the VOLUME + / VOLUME - key to switch to system recovery mode and press POWER key to confirm.
4. Use the VOLUME + / VOLUME - key to move the highlight bar on "wipe data / factory reset" and press POWER key to confirm.
5. Press VOLUME + / VOLUME - to select "yes" and press POWER key to confirm.
6. Select "reboot system now" and press POWER key to restart the system.
7. After resetting is complete, follow the on-screen instructions to finish the system settings.

6. How to activate new VCI device?

*Note: Before registration, please make sure the network is properly connected.

If you have activated a VCI device before and bought a new VCI device due to the loss or other reasons, please follow the below steps to activate:

1. On the Home screen, tap "User Info" -> "Activate VCI".
2. Input product S/N and activation code, which can be found from the included password envelope, then tap "Activate".
3. After activation completed, the tablet will automatically wirelessly connect to the VCI device. Tap "User Info" -> "VCI" to check if the activated VCI device is displayed in the connector list or not. Each tablet is allowed to bind multiple VCI devices. If you intend to use one of the VCI devices to diagnose / test a vehicle, just switch to the corresponding VCI device.

7. How to update Android?

A newer Android version will be released to bring better user experience and more capabilities. Please check for updates on regular basis.

*Note: Please make sure your tool battery has at least 70%. Do NOT run any other programs during the update.

1. On the Home screen, tap "Other Module" -> "Wireless Upgrade".
2. Tap "Check for updates". Once a newer version is found, follow the on-screen instructions to download and install the update file.
3. Be patient to wait until the update is done.

8. How to update the APK and diagnostic software?

*Note: During the update, please make sure the tool has a stable network connection.

1. On the Home screen, tap "Software Update".
2. To update all software, tap the "All software" tab and tap "Update" on the bottom of the screen to start the download.
3. To update some common software, tap the "Common software" tab to update the previously added common software list.

9. Can I use the VCI device to communicate with the tablet via Bluetooth?

The VCI device actually supports the Bluetooth communication, but this feature is currently disabled in the diagnostic application. The Wi-Fi communication between the tablet and the VCI is highly recommended since it provides more stable connection and faster transmission speed.

10. What to do if the tablet runs out of space when downloading software?

1. Refer to the item "How to back up data?" to back up the important data.
2. Delete the data that has been backed up to release the storage space.

11. How to back up data?

1. Turn the tablet on.
2. Plug the external storage device into the data transmission port (not type-C port) of the tablet.

*Note: For this tablet, the USB Type C interface is only for charging and disabled for data exchange. To exchange files with other external storage devices, please use the USB Type A interface only.

3. Go to "Other Modules" -> "Files" open the ES File Explorer.
4. After the tablet identifies the storage device, USBxxxx will appear under the Internal Storage.

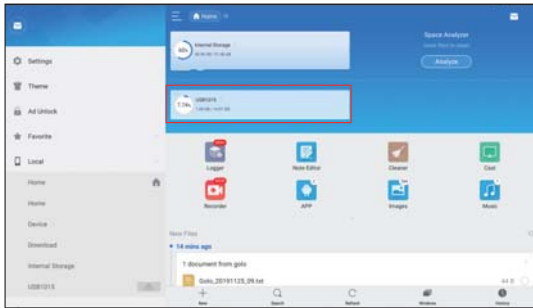

5. Tap on "Internal Storage"(*Note: Take "Pictures" for example).

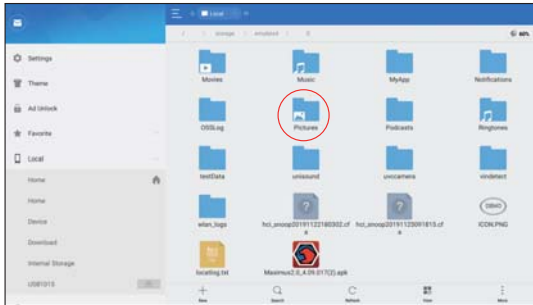

6. To copy all files in the "Screenshots" folder, tap on it for a while, all available operation options will appear.

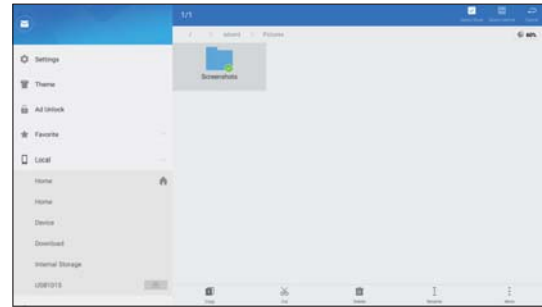

7. Tap on "Copy" on the bottom of the screen, the folder is successfully copied.

8. Tap on "USBxxxx" and select the target folder, tap on "Paste" to start copying.

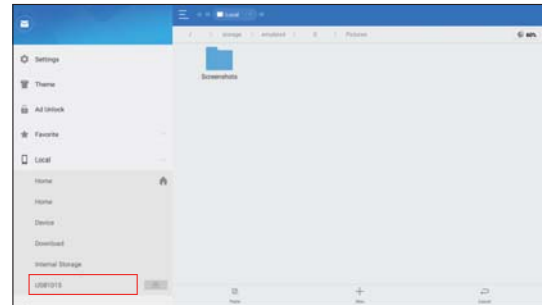

9. After the total progress reaches to 100%, the backup is OK. Unplug the storage device from the tablet.

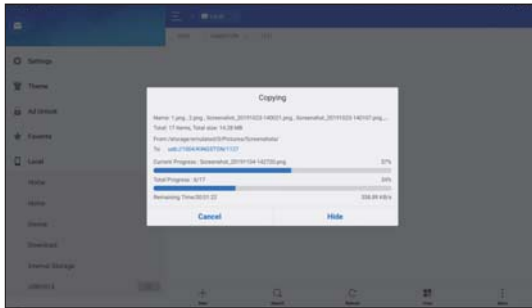

*Note: Another method is available for picture backup. User also can go to Gallery to select the desired folder/files and share it to the external storage device via “ES Save to...”.

12. The diagnostic application is failing.

1. On the Home screen, tap “Tablet Setting” -> “Apps”.
2. Select the application name from the Apps list.
3. Select “FORCE STOP”, and then press “OK” to confirm.
4. Select “Clear Data”, and then press “OK” to confirm.

13. How to retrieve the login password?

Please follow below steps to proceed in case you forgot the login password:

1. Tap [Login] button on the upper right corner of the screen.
2. Tap “Retrieve password”.
3. Input product S/N and follow the on-screen prompts to set a new password.

Warranty

THIS WARRANTY IS EXPRESSLY LIMITED TO PERSONS WHO PURCHASE LAUNCH PRODUCTS FOR PURPOSES OF RESALE OR USE IN THE ORDINARY COURSE OF THE BUYER'S BUSINESS.

LAUNCH electronic product is warranted against defects in materials and workmanship for one year (12 months) from date of delivery to the user.

This warranty does not cover any part that has been abused, altered, used for a purpose other than for which it was intended, or used in a manner inconsistent with instructions regarding use. The exclusive remedy for any automotive meter found to be defective is repair or replacement, and LAUNCH shall not be liable for any consequential or incidental damages.

Final determination of defects shall be made by LAUNCH in accordance with procedures established by LAUNCH. No agent, employee, or representative of LAUNCH has any authority to bind LAUNCH to any affirmation, representation, or warranty concerning LAUNCH automotive meters, except as stated herein.

Order Information

Replaceable and optional parts can be ordered directly from your LAUNCH authorized tool supplier. Your order should include the following information:

1. Quantity
2. Part number
3. Item description

Customer Service

If you have any questions on the operation of the unit, please contact local dealer, or contact **LAUNCH TECH. CO., LTD.:**

Website: www.x431.com

www.cnlaunch.com

Phone: +86 755 8455 7891

Email: overseas.service@cnlaunch.com

Statement: LAUNCH reserves the rights to make any change to this manual without notice. We have tried our best to make the descriptions and illustrations in the manual as accurate as possible, and defects are inevitable, if you have any question, please contact local dealer or LAUNCH TECH. CO., LTD., LAUNCH does not bear any responsibility arising from misunderstandings.