

Version: V1.00.000

Revised date: Sep-27-2018

Statement: LAUNCH owns the complete intellectual property rights for the software used by this product. For any reverse engineering or cracking actions against the software, LAUNCH will block the use of this product and reserve the right to pursue their legal liabilities.

Copyright Information

Copyright © 2018 by LAUNCH TECH. CO., LTD. All rights reserved. No part of this publication may be reproduced, stored in a retrieval system, or transmitted in any form or by any means, electronic, mechanical, photocopying, recording or otherwise, without the prior written permission of LAUNCH. The information contained herein is designed only for the use of this unit. LAUNCH is not responsible for any use of this information as applied to other units.

Neither LAUNCH nor its affiliates shall be liable to the purchaser of this unit or third parties for damages, losses, costs, or expenses incurred by purchaser or third parties as a result of: Accident, misuse, or abuse of this unit, or unauthorized modifications, repairs, or alterations to this unit, or failure to strictly comply with LAUNCH operating and maintenance instructions. LAUNCH shall not be liable for any damages or problems arising from the use of any options or any consumable products other than those designated as Original LAUNCH Products or LAUNCH Approved Products by LAUNCH.

Trademark Information

LAUNCH is a registered trademark of LAUNCH TECH CO., LTD. (LAUNCH) in China and other countries. All other LAUNCH trademarks, service marks, domain names, logos, and company names referred to in this manual are either trademarks, registered trademarks, service marks, domain names, logos, company names of or are otherwise the property of LAUNCH or its affiliates. In countries where any of the LAUNCH trademarks, service marks, domain names, logos and company names are not registered, LAUNCH claims other rights associated with unregistered trademarks, service marks, domain names, logos, and company names. Other products or company names referred to in this manual may be trademarks of their respective owners. You may not use any trademark, service mark, domain name, logo, or company name of LAUNCH or any third party without permission from the owner of the applicable trademark, service mark, domain name, logo, or company name. You may contact LAUNCH by visiting the website at www.cnlaunch.com, or writing to LAUNCH TECH. CO., LTD., Launch Industrial Park, North of Wuhe Avenue, Banxuegang, Bantian, Longgang, Shenzhen, Guangdong, P.R.China, to request written permission to use Materials on this manual for purposes or for all other questions relating to this manual.

Important Safety Precautions

Important: To avoid personal injury, property damage, or accidental damage to

the product, read all of the information in this section before using the product.

- Never collide, throw, or puncture the tool, and avoid falling, extruding and bending it.
- Do not insert foreign objects into or place heavy objects on your device. Sensitive components inside might cause damage.
- Do not use the tool in exceptionally cold or hot, dusty, damp or dry environments.
- In places using the tool may cause interference or generate a potential risk, please turn it off.
- X-431 PAD III is a sealed unit. There are no end-user serviceable parts inside. All internal repairs must be done by an authorized repair facility or qualified technician. If there is any inquiry, please contact the dealer.
- Never place the tool into apparatus with strong electromagnetic field.
- Keep the tool far away from magnetic devices because its radiations can damage the screen and erase the data stored on the tool.
- DANGER: Do not attempt to replace the internal rechargeable lithium battery. Contact the dealer for factory replacement.
- CAUTION: Please use the included battery and charger. Risk of explosion if the battery is replaced with an incorrect type.

Precautions on Using X-431 PAD III

Before using this tool, please read the following safety information carefully.

- Always perform automotive testing in a safe environment.
- If the VCI (Vehicle Communication Interface) device remains unused for a long period of time, it is suggested to unplug the connector from vehicle's DLC to conserve battery power.
- Wear an ANSI-approved eye shield when testing or repairing vehicles.
- The vehicle shall be tested in a well-ventilated work area, as engines produce various poisonous compounds (hydrocarbon, carbon monoxide, nitrogen oxides, etc.)
- Do not connect or disconnect any test equipment while the ignition is on or the engine is running.
- Put blocks in front of the drive wheels and never leave the vehicle unattended while testing.
- Keep the tool dry, clean, free from oil, water or grease. Use a mild detergent on a clean cloth to clear the outside of the equipment as necessary.

- Do not drive the vehicle and operate the tool at the same time. Any distraction may cause an accident.
- Keep clothing, hair, hands, tools, test equipment, etc. away from all moving or hot engine parts.
- Before starting the engine, put the gear lever in the Neutral position (for manual transmission) or in the Park (for automatic transmission) position to avoid injury.
- To avoid damaging the tool or generating false data, please make sure the vehicle battery is fully charged and the connection to the vehicle DLC (Data Link Connector) is clear and secure.
- Automotive batteries contain sulfuric acid that is harmful to skin. In operation, direct contact with the automotive batteries should be avoided. Keep the ignition sources away from the battery at all times.

Precautions on Operating Vehicle's ECU

- Do not disconnect battery or any wiring cables in the vehicle when the ignition switch is on, as this could avoid damage to the sensors or the ECU.
- Do not place any magnetic objects near the ECU. Disconnect the power supply to the ECU before performing any welding operations on the vehicle.
- Use extreme caution when performing any operations near the ECU or sensors. Ground yourself when you disassemble PROM, otherwise ECU and sensors can be damaged by static electricity.
- When reconnecting the ECU harness connector, be sure it is attached firmly, otherwise electronic elements, such as ICs inside the ECU, can be damaged.

TABLE OF CONTENTS

| | |
|---|-----------|
| 1 INTRODUCTION | 1 |
| 1.1 PRODUCT PROFILE | 1 |
| 1.2 FEATURES | 1 |
| 1.3 TECHNICAL SPECIFICATIONS | 2 |
| 1.3.1 X-431 PAD III tablet | 2 |
| 1.3.2 VCI connector (Only for Passenger Vehicle Version)..... | 3 |
| 1.3.2 VCI module (Only for Commercial Vehicle/ Gasoline & Diesel Version) | 3 |
| 2 KNOWLEDGE OF X-431 PAD III | 4 |
| 2.1 X-431 PAD III TABLET | 5 |
| 2.2 VCI CONNECTOR (ONLY FOR PASSENGER VEHICLE VERSION) | 7 |
| 2.2 VCI MODULE (ONLY FOR COMMERCIAL VEHICLE/GASOLINE & DIESEL VERSION) | 8 |
| 2.3 PACKAGE LIST | 9 |
| 3 INITIAL SETUP | 11 |
| 3.1 CHARGING X-431 PAD III | 11 |
| 3.2 POWER ON/OFF..... | 11 |
| 3.3 SCREEN LAYOUT..... | 11 |
| 3.4 ADJUSTING SCREEN BRIGHTNESS..... | 12 |
| 3.5 CHANGING LANGUAGE | 12 |
| 3.6 NETWORK SETUP..... | 13 |
| 3.6.1 Wired Connection | 13 |
| 3.6.2 Connect to a Wi-Fi network | 13 |
| 4 GETTING STARTED | 14 |
| 4.1 DIAGNOSTIC FLOWCHART | 14 |
| 4.2 REGISTER & DOWNLOAD DIAGNOSTIC SOFTWARE..... | 14 |
| 4.2.1 User registration | 14 |
| 4.2.2 Home screen | 18 |
| 4.2.3 Vehicle menu layout | 20 |
| 4.2.4 Diagnostics toolbar | 21 |
| 4.3 DIAGNOSIS METHODS (ONLY FOR PASSENGER VEHICLE VERSION) | 22 |
| 4.3 DIAGNOSIS METHODS (ONLY FOR COMMERCIAL VEHICLE/ GASOLINE & DIESEL VERSION) | 23 |

| | |
|---|-----------|
| 4.4 CONNECTIONS | 24 |
| 4.4.1 Preparation | 24 |
| 4.4.2 DLC location | 24 |
| 4.4.3 Vehicle connection (For Passenger Vehicle Version)..... | 24 |
| 4.3.3 Vehicle connection (For Commercial Vehicle/ Gasoline & Diesel Version)..... | 26 |
| 4.5 COMMUNICATION SETUP (ONLY FOR PASSENGER VEHICLE VERSION) | 27 |
| 4.5.1 Pairing up via Bluetooth..... | 27 |
| 4.5.2 USB cable connection | 28 |
| 4.5 COMMUNICATION SETUP (ONLY FOR COMMERCIAL VEHICLE/ GASOLINE & DIESEL VERSION) | 28 |
| 4.5.1 Pairing up via Bluetooth..... | 28 |
| 4.5.2 USB cable connection | 29 |
| 4.5.3 Wi-Fi communication | 29 |
| 5 DIAGNOSIS..... | 32 |
| 5.1 INTELLIGENT DIAGNOSIS (AUTODETECT)..... | 32 |
| 5.2 LOCAL DIAGNOSIS..... | 37 |
| 5.2.1 Health Report (Quick Test) | 41 |
| 5.2.2 System Scan..... | 43 |
| 5.2.3 System Selection | 44 |
| 5.3 REMOTE DIAGNOSIS | 51 |
| 5.3.1 Interface layout | 51 |
| 5.3.2 Add friends..... | 52 |
| 5.3.3 Start instant messaging | 53 |
| 5.3.4 Launch remote diagnosis (Device-To-Device) | 55 |
| 5.3.5 Launch remote diagnosis (Device-To-PC) | 58 |
| 5.4 HOW TO VIEW DIAGNOSTIC HISTORY? | 60 |
| 5.5 HOW TO FEEDBACK DIAGNOSTIC LOGS? | 61 |
| 6 SPECIAL (RESET) FUNCTION (ONLY FOR PASSENGER VEHICLE/GASOLINE & DIESEL VERSION)..... | 64 |
| 6.1 OIL RESET SERVICE..... | 65 |
| 6.2 ELECTRONIC PARKING BRAKE RESET..... | 65 |
| 6.3 STEERING ANGLE CALIBRATION | 66 |
| 6.4 ABS BLEEDING | 66 |
| 6.5 TIRE PRESSURE MONITOR SYSTEM RESET | 66 |

| | |
|---|-----------|
| 6.6 GEAR LEARNING | 66 |
| 6.7 IMMO SERVICE | 67 |
| 6.8 INJECTOR CODING | 67 |
| 6.9 BATTERY MAINTENANCE SYSTEM RESET | 68 |
| 6.10 DIESEL PARTICULATE FILTER (DPF) REGENERATION | 68 |
| 6.11 ELECTRONIC THROTTLE POSITION RESET | 68 |
| 7 SOFTWARE UPDATE..... | 69 |
| 8 GOLO BUSINESS MANAGER..... | 70 |
| 9 SENSORBOX (TOOLBOX) | 72 |
| 9.1 PRODUCT SUMMARY | 72 |
| 9.2 STRUCTURE & ACCESSORIES..... | 73 |
| 9.2.1 Sensorbox structure | 73 |
| 9.2.2 Sensorbox accessories | 74 |
| 9.3 SENSOR SIMULATION | 75 |
| 9.3.1 Connections..... | 75 |
| 9.3.2 Simulation test | 76 |
| 9.3.3 Precautions on checking vehicle sensor | 80 |
| 10 MULTIMETER (TOOLBOX) | 82 |
| 10.1 MAIN MENU | 82 |
| 10.2 TEST SAMPLE | 83 |
| 11 BATTERYBOX (TOOLBOX) | 85 |
| 11.1 PRODUCT SUMMARY | 85 |
| 11.2 TEST ENVIRONMENT | 86 |
| 11.2.1 Test environment..... | 86 |
| 11.2.2 Battery status and description | 86 |
| 11.3 BATTERYBOX STRUCTURE & ACCESSORIES | 87 |
| 11.3.1 Batterybox structure..... | 87 |
| 11.3.2 Test accessories | 87 |
| 11.4. CONNECTIONS & OPERATIONS | 88 |
| 11.4.1 Connection..... | 88 |
| 11.4.2 Inside the vehicle test | 88 |
| 11.4.3 Outside the vehicle test | 91 |
| 11.5 PRECAUTIONS ON BATTERY TEST..... | 91 |

| | |
|---|------------|
| 12 OSCILLOSCOPE (TOOLBOX) | 94 |
| 12.1 INTRODUCTION | 94 |
| 12.2 STRUCTURE & ACCESSORIES..... | 95 |
| 12.2.1 Scopebox structure..... | 95 |
| 12.2.2 Scopebox accessories..... | 96 |
| 12.3 CONNECTION & INITIAL USE | 99 |
| 12.3.1 Probe Compensation..... | 99 |
| 12.3.2 Connection..... | 101 |
| 12.3.3 Initial interface introduction..... | 103 |
| 12.4 OPERATIONS | 105 |
| 12.4.1 Channel selection and attributes setting | 105 |
| 12.4.2 Auto..... | 110 |
| 12.4.3 View Settings..... | 110 |
| 12.4.4 Measure..... | 111 |
| 12.4.5 File management..... | 113 |
| 12.4.6 Expert reference..... | 114 |
| 13 AUTOMOTIVE IGNITION WAVEFORM (TOOLBOX) | 116 |
| 13.1 SECONDARY-DISTRIBUTOR IGNITION ANALYSIS | 116 |
| 13.2 SECONDARY-SIMULTANEOUS IGNITION ANALYSIS..... | 119 |
| 13.3 SECONDARY-DIRECT IGNITION ANALYSIS | 121 |
| 13.4 WAVEFORM ANALYSIS MODE | 123 |
| 14 PERSONAL CENTER..... | 129 |
| 14.1 MY REPORT..... | 129 |
| 14.2 VCI..... | 131 |
| 14.3 VCI MANAGEMENT (FOR PASSENGER VEHICLE VERSION) | 131 |
| 14.3 VCI MANAGEMENT (ONLY FOR COMMERCIAL / GASOLINE & DIESEL VERSION) | |
| 132 | |
| 14.4 ACTIVATE VCI..... | 132 |
| 14.5 FIRMWARE FIX..... | 133 |
| 14.6 PROFILE | 133 |
| 14.7 CHANGE PASSWORD..... | 134 |
| 14.8 SETTINGS | 134 |
| 14.8.1 Units of Measurement | 134 |
| 14.8.2 Shop Information | 134 |
| 14.8.3 Printer Set..... | 135 |

| | |
|---|------------|
| 14.8.4 About..... | 137 |
| 14.8.5 Clear Cache..... | 137 |
| 14.8.6 Login/Exit from current account..... | 137 |
| 15 OTHER MODULES | 138 |
| 15.1 EMAIL | 138 |
| 15.2 BROWSER..... | 138 |
| 15.2.1 Open browser | 138 |
| 15.2.2 Download files | 139 |
| 15.3 TEAMVIEWER..... | 139 |
| 15.4 SYSTEM OTA UPGRADE | 140 |
| 15.5 FACEBOOK..... | 141 |
| 15.6 WALLET | 141 |
| 15.6.1 Registering Wallet..... | 141 |
| 15.6.2 How to Obtain Wallet Tokens..... | 141 |
| 15.6.3 Checking Wallet Tokens | 142 |
| 15.6.4 How to Backup Wallet Tokens | 143 |
| 15.7 ES FILE EXPLORER..... | 145 |
| 15.8 ALBUM..... | 145 |
| 15.9 SYNCHRONIZATION | 145 |
| 16 FAQ | 147 |

1 Introduction

1.1 Product Profile

Featuring customized Android operating system, 2.0GHz 8-core CPU and 10.1" display screen, X-431 PAD III has functions of vehicle diagnosis, oscilloscope, ignition, sensor, multimeter, browser and battery test etc.

It features wired network, meanwhile it also supports Wi-Fi communication, which enables you to surf the Internet, update App and diagnostic software online, search repair information anytime and anywhere, getting your job faster and easier.

Moreover, HDMI extending display function is available. As a result, it has strong practicability and high performance-price ratio, which is a helpful assistant for vehicle repair and maintenance.

1.2 Features

1. Diagnose:

- **Smart Diagnosis:** This module allows you to use the VIN information of the currently identified vehicle to access its data (including vehicle information, historical diagnostic records) from the cloud server to perform quick test.
- **Local Diagnosis:** VINscan quick test and manual diagnosis are available. Diagnosis functions include: Read DTCs, Clear DTCs, Read Data Stream, Special Functions etc.
- **Remote Diagnosis:** This option aims to help repair shops or technicians launch instant messaging and remote diagnosis, making the repair job getting fixed faster.
- **Reset:** All kinds of common maintenance and reset items including Oil lamp reset, DPF regeneration, ABS bleeding can be done.
- **One-click Update:** Lets you update your diagnostic software online.
- **Diagnostic History:** This function provides a quick access to the tested vehicles and users can choose to view the test report or resume from the last operation, without the necessity of starting from scratch.
- **Diagnostic Feedback:** Enables you to submit the vehicle issue to us for analysis and troubleshooting.
- **golo Business Manager:** On this platform, you can provide nearby car

owners with attentive service to develop new business opportunities, manage technicians and golo customers more efficiently, monitor customer's vehicle running status in real-time manner and perform remote assistance anywhere etc. It is very helpful to increase productivity and boost shop revenue.

- Testable Models: Quick dial to view the vehicle models that the tool covers.
2. Wi-Fi connection and Ethernet connection are supported.
 3. HDMI interface is provided for connecting the external projectors or displays.
 4. Equipped with USB port for connecting USB devices and other add-on modules such as Scopebox, Sensorbox, Batterybox and Videoscope.
 5. Web browser: Users can make online search and visit any website.

1.3 Technical Specifications

1.3.1 X-431 PAD III tablet

| | |
|--------------------|--|
| CPU | 8-core Processor, 2.0GHz |
| Display | 10.1 inch touch screen with a resolution of 1920 x 1200P |
| Memory | 2GB |
| Hard disk | 64GB |
| Connectivity | <ul style="list-style-type: none"> • Ethernet/Wi-Fi (802.11 b/g/n) • USB: 2.0 • Bluetooth 2.0 |
| Camera | 2.0MP front-facing camera + 8.0MP rear-facing camera |
| Sensor | Gravity Accelerometer |
| Audio Input/Output | <ul style="list-style-type: none"> • Microphone • Speakers • 3.5mm stereo headset jack |

| | |
|---------|----------------------------------|
| Battery | 15000mAh lithium-polymer battery |
|---------|----------------------------------|

| | |
|-----------------|--------------------------|
| Operating Temp. | -10°C ~ 55°C (14 ~131°F) |
|-----------------|--------------------------|

| | |
|---------------|--------------------------|
| Storage Temp. | -20°C ~ 70°C (-4 ~158°F) |
|---------------|--------------------------|

1.3.2 VCI connector (Only for Passenger Vehicle Version)

| | |
|-----------------|-------------|
| Working Voltage | DC 9V ~ 18V |
|-----------------|-------------|

| | |
|---------------|--------------------------|
| Working Temp. | -10°C ~ 55°C (14 ~131°F) |
|---------------|--------------------------|

| | |
|---------------|--------------------------|
| Storage Temp. | -20°C ~ 70°C (-4 ~158°F) |
|---------------|--------------------------|

| | |
|-------------------|-----------|
| Relative Humidity | 20% ~ 90% |
|-------------------|-----------|

1.3.2 VCI module (Only for Commercial Vehicle/ Gasoline & Diesel Version)

| | |
|-----------------|-----------|
| Working voltage | DC 9 ~36V |
|-----------------|-----------|

| | |
|-------------------|------|
| Power consumption | ≤ 3W |
|-------------------|------|

| | |
|---------------|---------------------------------------|
| Communication | Via Bluetooth/Wi-Fi or USB connection |
|---------------|---------------------------------------|

| | |
|---------------------|-------------|
| Working temperature | -10 to 50°C |
|---------------------|-------------|

| | |
|--------------|---|
| Wi-Fi module | HLK-RM08K |
| | <ul style="list-style-type: none"> • Frequency range: 2412-2472MHz • Transmit power: 19.29dBm |

| | |
|------------------|---|
| Bluetooth module | YG-218M-A2 |
| | <ul style="list-style-type: none"> • Frequency range: 2402-2480MHz • Transmit power: 16.62dBm |

2 Knowledge of X-431 PAD III

There are two main components to the X-431 PAD III system:

- X-431 PAD III Tablet – the central processor and monitor for the system (See Chapter “2.1”).



Fig. 2-1 X-431 PAD III tablet

- VCI Device – the device for accessing vehicle data (See Chapter “2.3”).



Fig. 2-2 (Only for Passenger Vehicle Version)



Fig. 2-2 (Only for Commercial Vehicle / Gasoline & Diesel Version)

2.1 X-431 PAD III Tablet

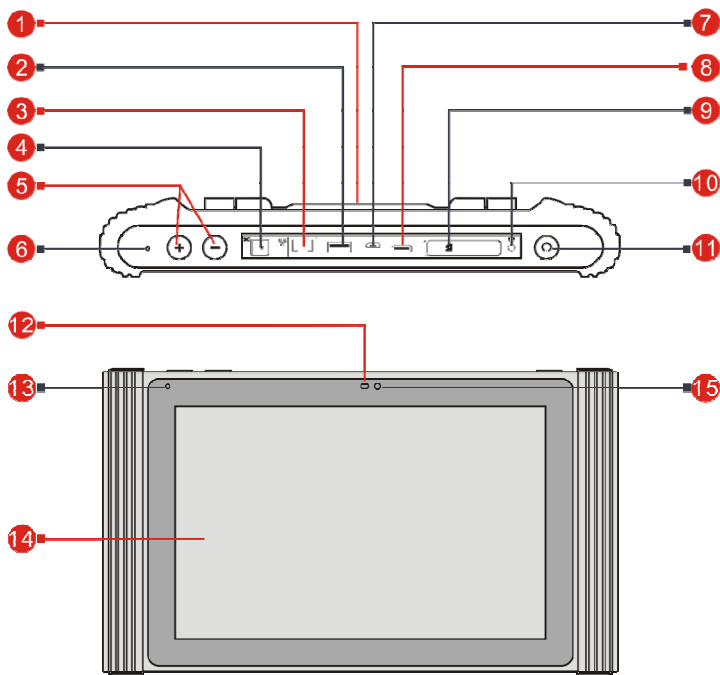

Fig. 2-3 X-431 PAD III tablet

| | | |
|---|-----------------------------|--|
| 1 | Adjustable kickstand | Flip out it to any angle and work comfortable at your desk, or hang it on automotive part. |
| 2 | USB2 Port | To connect the USB devices or add-on USB modules (Scopebox, Sensorbox or Batterybox) while extending X-431 PAD III function. |
| 3 | Ethernet port | To connect the Ethernet cable for wired network. |
| 4 | DC IN Port | To connect the included power adaptor. |

| | | |
|----|------------------------------|--|
| 5 | VOLUME +/- Key | To adjust the volume. |
| 6 | Reset Switch | |
| 7 | USB1 Port | Only reserved for Micro USB cable. |
| 8 | HDMI Port | To connect an external projector or monitor with HDMI interface. |
| 9 | Memory Card Slot | To insert a memory card for memory extension. |
| 10 | Earphone Jack | |
| 11 | POWER/Screen Lock Key | <p>In Off mode, press it for 3 seconds to turn the handset on.</p> <p>In On mode:</p> <ul style="list-style-type: none">• Press it to activate the LCD if the LCD is off.• Press it to turn off the LCD if the LCD lights up.• Press it for 3 seconds to turn it off.• Press it for 8 seconds to perform forced shutdown. |
| 12 | Ambient Light Sensor | |
| 13 | Charging LED | |
| 14 | Touch Screen | |
| 15 | Front Camera | |

2.2 VCI Connector (Only for Passenger Vehicle Version)

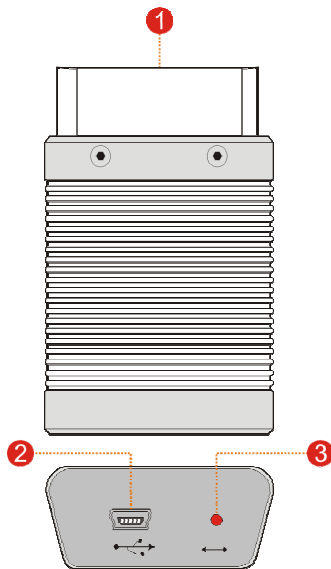

Fig. 1-2 VCI connector

| | | |
|---|------------------------------------|--|
| 1 | OBD-16 diagnostic connector | To connect on vehicle's OBD2 DLC. |
| 2 | Mini USB port | For connecting the USB cable to the tablet to perform vehicle diagnosis. |
| 3 | Mode indicator | <ul style="list-style-type: none"> • It illuminates red when the VCI connector is connected to the vehicle's DLC. • Blue indicates the VCI connector is working in Bluetooth mode. |

2.2 VCI Module (Only for Commercial Vehicle/Gasoline & Diesel Version)

Compatible with Passenger & Commercial vehicles, the VCI module works as a vehicle communication interface device. It is used to read the vehicle data and then send it to the tablet via Bluetooth/Wi-Fi communication or USB cable connection. The LED indicators enable you to easily identify the working status of the module.

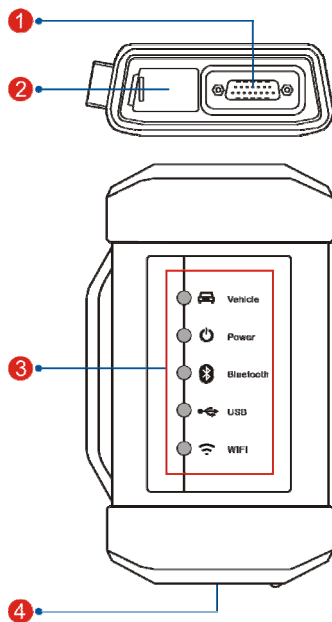

Fig. 1-4 VCI module

- 1 Diagnostic socket: For connecting the diagnostic cable.
- 2 DC-IN power jack: For connecting the power adaptor.
- 3 LED Indicators: It is defined as follows:
 - Vehicle: While communicating with the vehicle, the indicator lights up

and flashes. Otherwise, it will not illuminate.

- **Power:** It illuminates solid red when the module is powered on.
- **Bluetooth:** Blue indicates the module is working in Bluetooth mode.
- **USB:** It lights up when the module is connected to the diagnostic tool via USB cable.
- **Wi-Fi:** It lights up when the module works as a Wi-Fi hotspot or wireless adaptor.

-
- 4 **USB port:** For connecting it to the handset via USB cable to perform vehicle diagnosis.
-

2.3 Package List

Common accessories for each X-431 PAD III are same, but for different destinations, the accessories of X-431 PAD III may vary. For detailed accessory items, please consult from the local agency or check the packing list supplied with X-431 PAD III together.

| No. | Item | Description | Qt. |
|-----|-------------------------|--|-----|
| 1 | X-431 PAD III tablet | For analyzing the vehicle data and indicating the test results. | 1 |
| 2 | VCI connector | For connecting to vehicle's OBD II DLC to access vehicle's live data. | 1 |
| 3 | OBD II extension cable | For connecting the VCI connector for extension purpose. | 1 |
| 4 | OBD I adaptor | For connecting the non-16pin connector to the VCI connector. | 1 |
| 5 | Cigarette lighter cable | Optional. To supply power to the non-16pin connector through connection to the vehicle's cigarette lighter receptacle. | 1 |
| 6 | Battery clamps cable | Optional. To supply power to the non-16pin connector through connection to the vehicle's battery. | 1 |

| | | | |
|----|-----------------------------|---|---|
| 7 | BMW F chassis line | | 1 |
| 8 | Power adaptors | 1 for America area and 1 for Europe area | 2 |
| 9 | Micro-USB cable | For connecting the VCI connector to the tablet to perform vehicle diagnosis. | 1 |
| 10 | Password envelope | A piece of paper bearing Product S/N and Activation Code, which is needed for product registration. | 1 |
| 11 | Ethernet crossover cable | | 1 |
| 12 | Non-16pin adaptor cable kit | Optional. For connecting to Non-OBD II vehicle DLC. | 1 |



3 Initial Setup

3.1 Charging X-431 PAD III

*Notes:

- Only use the included power adaptor to recharge the tablet. Use of any other adaptor will damage the tool. We assume no responsibility for damage or loss resulting from using other similar adaptors other than the specified one.
- Always charge on a non-flammable surface in a well-ventilated area.

To check the battery power level, press and hold the Power button about 3 seconds to turn on the tablet. Power level is indicated as a percentage in the upper right corner of the screen. If the power level drops below 10% while the tablet is on, a “Connect Charger” notification will appear on the screen.

1. Connect one end of the power adaptor to DC IN port of the tablet, and the other end to the AC outlet.
2. If  appears on the screen, it indicates it is being charged. If the logo changes into , it indicates that the battery is fully charged.
3. Disconnect the power adaptor from the AC outlet.

3.2 Power On/Off







1. Press and hold the POWER button for about 3 seconds to turn on the tablet. The system starts initializing and then enters the Home screen.
2. To turn the tablet off, press and hold the POWER button until an option menu appears. Tap “Power Off”.

3.3 Screen Layout

On-screen keys and status bar are as follows:



Fig. 3-4

-
- 1 Tap  to visit the official website.
 - 2 Tap  to capture the current screen and all captured screenshots are stored in the Screenshots folder.
 - 3  shows whether the VCI device is connected properly or not.
 - 4 Tap  to display a list of applications that are currently running or recently used. To open an application, tap it. To remove an application, swipe it upwards.
 - 5 Tap  to jump to the Home screen.
 - 6 Tap  to return to the previous screen or exit the application.
-

3.4 Adjusting Screen Brightness

The tablet is equipped with a built-in light intensity sensor. It can adjust the screen brightness according to the ambient light intensity automatically. Alternatively, you can also adjust it manually.

1. On the Home screen, tap **Tablet Settings -> Display -> Brightness**.
2. Drag the slider to adjust it.

Alternatively, user may also slide the “Automatically brightness” switch to ON, and the system will automatically adjust the screen brightness.

*Tips: Reducing the brightness of the screen is helpful to save the power of the tablet.

3.5 Changing Language

The handset supports multiple languages. To change the language of the tablet, please do the following:

1. On the Home screen, tap **Tablet Settings -> Language**.
2. Tap the desired language from the list and the system will change to the chosen language.

3.6 Network Setup

There are 2 kinds of network connection available on the tablet.

3.6.1 Wired Connection

Connect the Ethernet crossover cable to the tablet, and the system will directly use the Ethernet connection as the default connection since it provides more stable and faster network speed.

3.6.2 Connect to a Wi-Fi network

The tablet has built-in Wi-Fi that can be used to get online. Once you're online, you can register the tablet, browse the Internet, get and update apps and send email on your network.

*Note: Once WLAN is set as ON, the tablet will consume more power. While WLAN keeps unused, please turn it off to conserve battery power.

1. On the Home screen, tap **Tablet Settings -> WLAN**.
2. Tap or slide the Wi-Fi switch to ON, the tablet starts searching for all available wireless LANs.
3. Choose the desired Wi-Fi access point / network,
 - If the network you chose is open, you can connect directly;
 - If the selected network is encrypted, you have to enter the right security key (network password).

When this tool is in range, it will connect to the previously linked network automatically.

4 Getting Started

4.1 Diagnostic Flowchart

For new users, please follow the operation chart shown in Fig. 4-1 to start using X-431 PAD III.

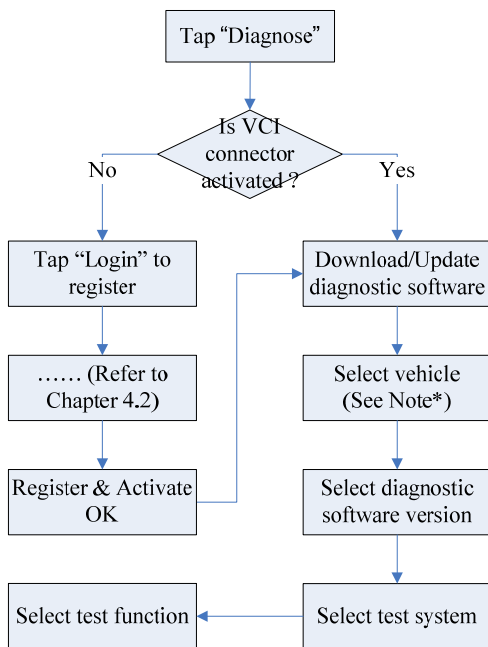

Fig. 4-1

*Note: If “VIN Scan” or “Intelligent Diagnosis” is selected to diagnose a vehicle, this step shall not apply.

4.2 Register & Download Diagnostic Software

4.2.1 User registration

After the tablet is initialized, a screen similar to the following appears.

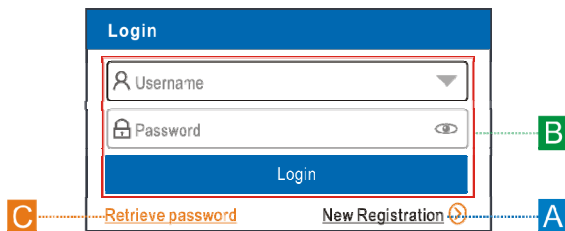

Fig. 4-2

(If you are a new user, follow **A** to proceed.)

(If you have registered to be a member, go to **B** to login the system directly.)

(In case you forgot password, refer to **C** to reset a new password.)

A. If you are a new user, tap "New Registration" to enter sign-up page. See Fig. 4-3.

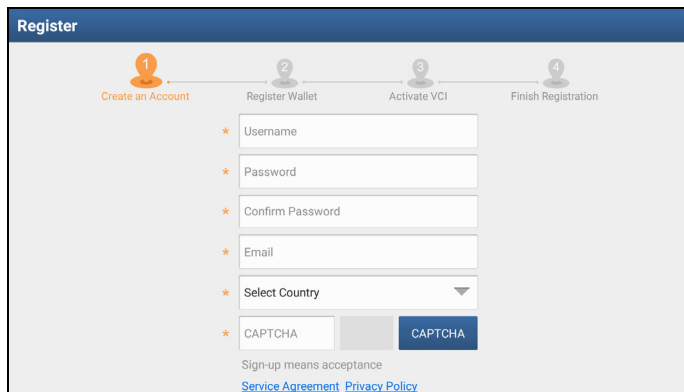

Fig. 4-3

1. **Create an App Account**: Input the information to create a new account (all fields must be completed). When finished tap "Register", a screen similar to the following will appear:

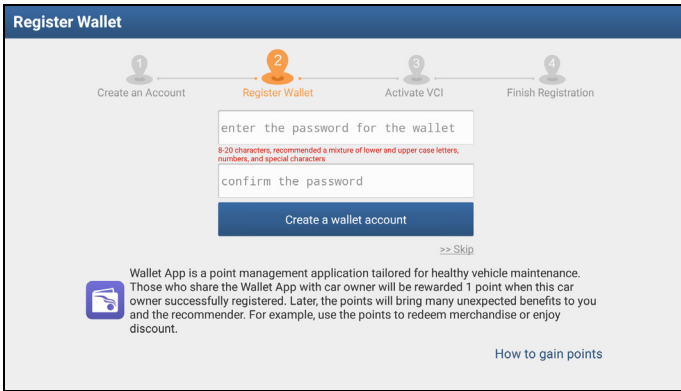

Fig. 4-4

2. Register Wallet: Input the password for the Wallet (An 8-20 mixture of lower/upper case letters, numbers and special characters is recommended), and then tap “Create a Wallet account”.

*Note: You are suggested to note the password down for future use.

Backup Wallet Address & Keystore: A wallet address is automatically generated, tap “To Back Up”, and then follow the on-screen instructions to store it.

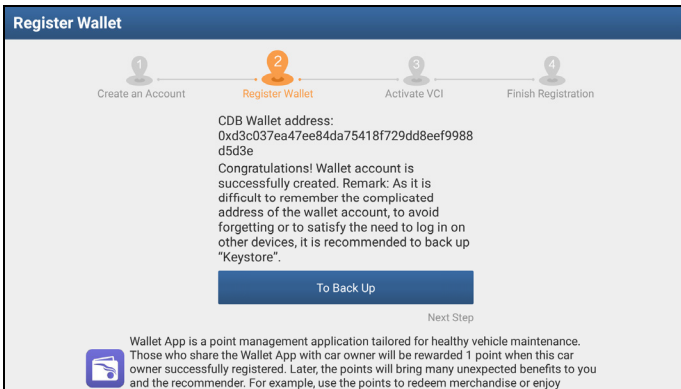

Fig. 4-5

*Note: For detailed backup process, please refer to Chapter 15.6.4.

3. Activate VCI: After registering a wallet account, the system navigates to the following screen:

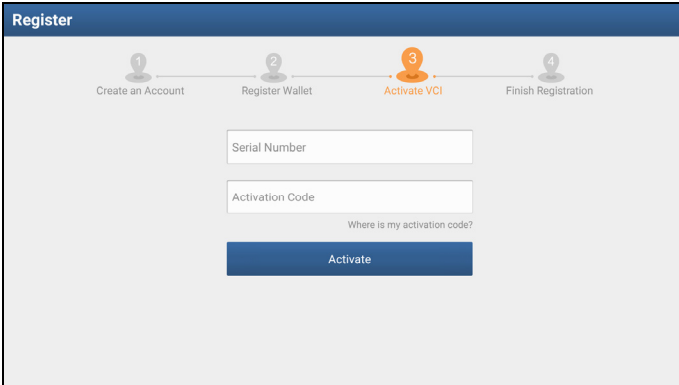
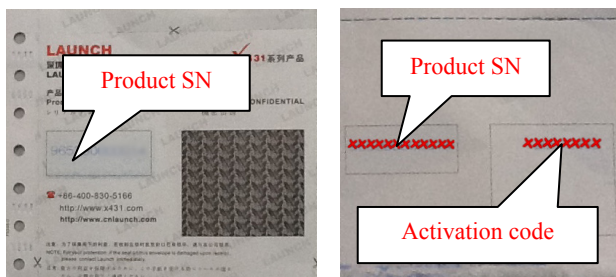

Fig. 4-6

In Fig. 4-6, input the Product Serial Number and Activation Code, which can be found in the supplied password envelope.



*Note: To exit and activate it later, tap “Skip”. In this case, you can activate your VCI by tapping “Activate VCI” in “Personal Center”. For details, please refer to Chapter 14.4.

Tap “Activate” to finish your registration. A popup displays to ask you to update the diagnostic software.

To update the diagnostic software, tap “Yes” to enter the vehicle software download screen. Tap “Update” to start downloading. To pause downloading, tap “Stop”. To resume, tap “Continue”. When download is complete, the system will install the software package automatically.

*Note: When downloading the diagnostic software or checking for updates, make sure the tablet has a strong Wi-Fi connection. It may take several minutes to finish it, please be patient to wait.

To download and install the software later, tap “No”. In this case, enter the Home screen and tap “Software Upgrade” to download the diagnostic software.

B. If you have registered to be a member, input your name and password, and then tap the “Login” button to enter the main menu screen directly.

*Note: The X-431 PAD III has an auto-save function. Once the username and password are correctly entered, the system will automatically store it. After initial setup, it is no longer necessary to input the account information manually to log in.

C. If you forgot the password, tap “Retrieve password” and then follow on-screen instructions to set a new password.

4.2.2 Home screen

It mainly includes the following items:

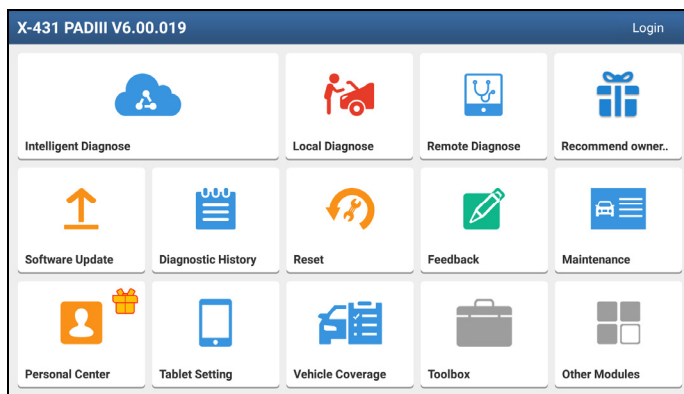

Fig. 4-7

| Name | Description |
|-----------------------------|---|
| Intelligent Diagnose | This module allows you to obtain vehicle data from the cloud server to perform quick test via reading VIN, which provides a perfect solution to various defects resulting from step-by-step menu selection. In addition, user can also check the historical repair records online |

| | |
|-------------------------------------|---|
| | through this module. |
| Local Diagnose | To diagnose a vehicle manually. |
| Remote Diagnose | This option aims to help repair shops or technicians launch instant messaging and remote diagnosis, making the repair job getting fixed faster. |
| Recommend owners bonus token | Wallet App is a point (token) management application tailored for healthy vehicle maintenance. Those who share the Wallet App with car owner will be rewarded 1 point (token) when this car owner successfully registered. Later, the points will bring many unexpected benefits to you and the recommender. For detailed operations, please refer to Chapter 15.6. |
| Software Upgrade | To update vehicle diagnostic software and APK. |
| Diagnostic History | Generally when a vehicle diagnosis is performed, X-431 PAD III records detailed diagnostic information. This function provides a quick access to diagnostic reports from previously tested vehicles. Testing can be resumed from the previous operation without starting from scratch. |
| Reset | To perform all kinds of common repair & maintenance items, including electronic throttle position reset, ABS bleeding, DPF regeneration, oil lamp reset etc. *Note: This module only applies to Passenger Vehicle /Gasoline & Diesel Version. |
| Feedback | To feed back the recent 20 diagnostic logs to us for issue analysis. |
| Maintenance | Abundant maintenance data are available, which helps repair professionals diagnose and repair vehicles efficiently, accurately and profitably. |
| Personal Center | To manage VCI, diagnostic reports & records, change password, configure printer, sample data and logout / login etc. |

| | |
|-------------------------|--|
| Tablet Setting | Configures the system setting of the tablet. |
| Vehicle Coverage | To check the vehicle models supported on the X-431 PAD III. |
| Toolbox | Includes Camera, Oscilloscope, Ignition, Sensor, Multimeter, Battery etc. |
| Other Modules | Includes TeamViewer, Email, Browser, golo business manager and product manual etc. |

4.2.3 Vehicle menu layout

After downloading the diagnostic software, you can go to “Local Diagnosis” to check if all software are completely downloaded and installed.

Tap “Local Diagnosis”, a screen similar to the following figure appears:

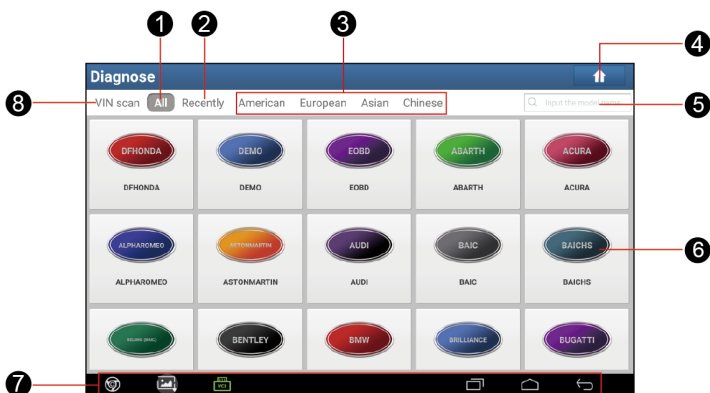

Fig. 4-8

1 **All Tab:** Displays all the vehicle makes in the vehicle menu.

2 **Recently Tab:** Displays all the recently tested vehicle makes.

3 **Regional buttons:** Tap different buttons to switch to corresponding vehicles. If you have purchased an X-431 PAD III of Gasoline & Diesel Version, a Heavy-duty tab will appear next to the regional button.

-
- 4 Home Button: Navigates to the Home screen.
-
- 5 Search bar: Enables you to use the virtual keyboard to quickly locate the vehicle model. Input the desired vehicle model to start searching.
-
- 6 Vehicle model display area
-
- 7 Locator & navigation buttons: Refer to Chapter 3.3 for details.
-
- VINScan** button: Tap it to scan the Vehicle Identification Number (VIN) code of your vehicle. OBD VIN and INPUT VIN are included. This function does not apply to the commercial vehicles.
- 8 *Note: Before using this function, the corresponding diagnostic software and Auto search file need to be downloaded on your tool first while downloading the diagnostic software.
-

4.2.4 Diagnostics toolbar

The diagnostics toolbar contains a number of buttons that enable various procedures. It is displayed at the top of the vehicle diagnostic screen throughout the whole diagnostic session. Refer to the table below for a brief description of the functions of the diagnostics toolbar buttons:

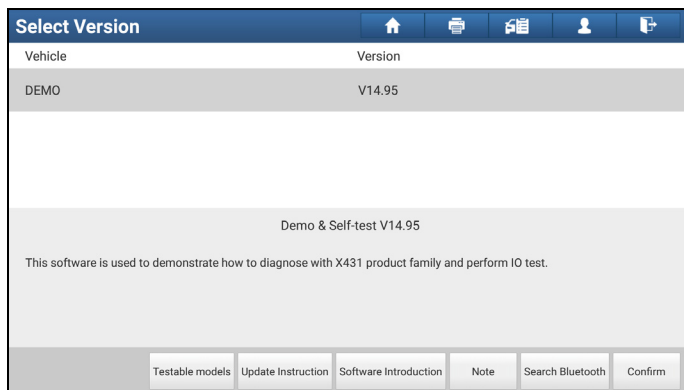







Fig. 4-9

| Name | Icon | Function |
|-----------------|---|---|
| Home |  | Return to the Home screen. |
| Print |  | Tap to print the current screen. To perform printing, you need to purchase an extra Wi-Fi printer manufactured by LAUNCH separately and then properly configure the wireless printer following the steps described in Chapter 15.3. |
| Testable Model |  | Inquires the vehicle models that the X-431 PAD III supports. |
| Personal Center |  | Quick access to personal center. |
| Exit |  | Exit the diagnostic application. |

4.3 Diagnosis Methods (Only for Passenger Vehicle Version)

X-431 PAD III tablet supports 2 communication methods with the VCI connector: wireless Bluetooth and USB cable. You may choose any one of the methods to diagnose a vehicle.

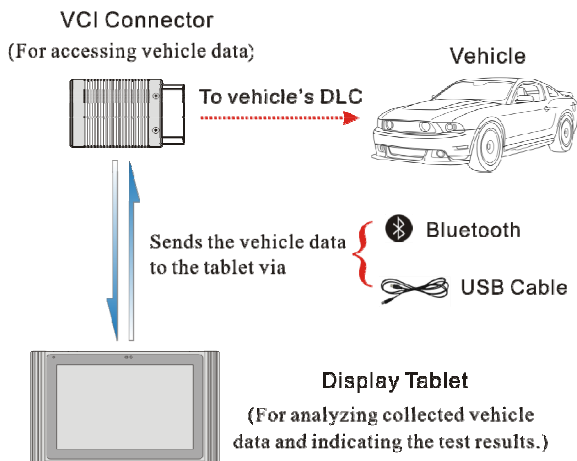

Fig. 4-10

*Notes:

- While using the diagnosis via Bluetooth, the VCI connector should be paired with the tablet. If no Bluetooth setting is done before diagnostic software is launched, you can also configure it while using the software.
- To obtain stable communication, you are strongly recommended to perform the vehicle diagnosis via USB cable. In this case, the USB cable is required to connect the VCI connector and the tablet.

4.3 Diagnosis Methods (Only for Commercial Vehicle/ Gasoline & Diesel Version)

X-431 PAD III tablet supports 3 communication methods with the VCI connector: wireless Bluetooth and USB cable. Choose any one of the methods to diagnose a vehicle.

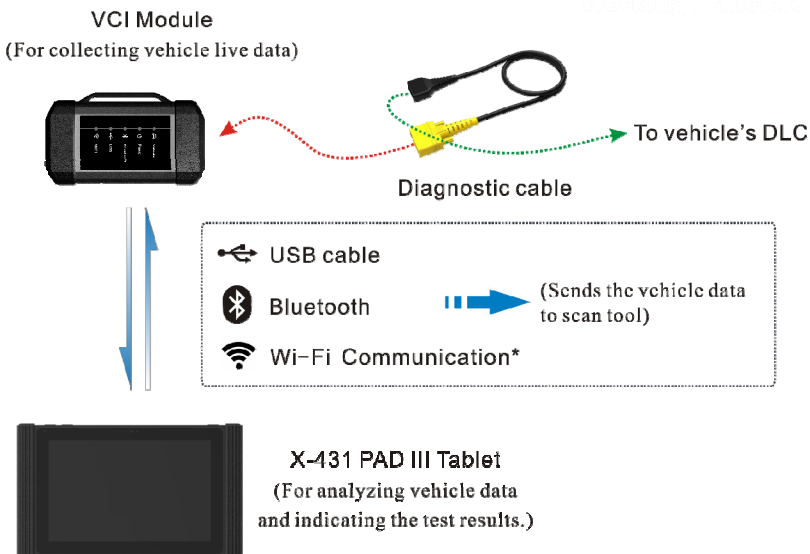

Fig. 4-10

*Notes:

- While using the diagnosis via Bluetooth, the VCI module should be paired with the X-431 PAD III tablet. If no Bluetooth setting is done before diagnostic software is

launched, you can also configure it while using the software.

- To obtain stable communication, you are strongly recommended to perform the vehicle diagnosis via USB cable. In this case, the USB cable is required to connect the VCI module and the X-431 PAD III tablet.
- To ensure that the X-431 PAD III tablet can work with the VCI module via Wi-Fi communication, a Wi-Fi configuration is required. Refer to Chapter 4.5.3 for details.
- When all communication methods are applied at the same time, the X-431 PAD III system will use the USB communication as the default priority.

4.4 Connections

4.4.1 Preparation

Normal testing conditions

- Turn on the vehicle power supply.
- Throttle should be in a closed position.

4.4.2 DLC location

The DLC (Data Link Connector) is typically a standard 16 pin connector where diagnostic code readers interface with the vehicle's on-board computer. The DLC is usually located 12 inches from the center of the instrument panel (dash), under or around the driver's side for most vehicles. If Data Link Connector is not located under dashboard, a label should be there telling location. For some Asian and European vehicles, the DLC is located behind the ashtray and the ashtray must be removed to access the connector. If the DLC cannot be found, refer to the vehicle's service manual for the location.

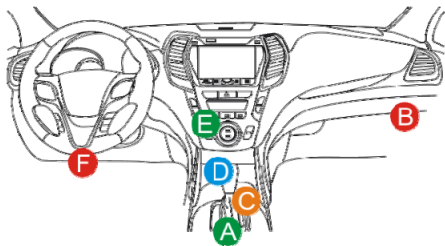

Fig. 4-11

4.4.3 Vehicle connection (For Passenger Vehicle Version)

The method used to connect the diagnostic connector to a vehicle's DLC

depends on the vehicle's configuration as follows:

- A vehicle equipped with an OBD II management system supplies both communication and 12V power through a standardized DLC.
- A vehicle not equipped with an OBD II management system supplies communication through a DLC connection, and in some cases supplies 12V power through the cigarette lighter receptacle or a connection to the vehicle battery.

Follow the steps mentioned below to connect OBD II vehicle:

1. Locate vehicle's DLC socket.
2. Plug the VCI connector into the vehicle's DLC socket (It is suggested to use the OBD II extension cable to connect the VCI connector and DLC socket).



Fig. 4-12

3. Choose one of the two ways to obtain power from:
 - A. Power adaptor: Connect one end of the included power adaptor to DC IN port of X-431 PAD III tablet, and the other end to AC outlet.
 - B. Internal battery pack

For non-OBDII vehicle, proceed as follows:

1. Locate vehicle's DLC socket.
2. Select the corresponding non-16pin connector.
3. Plug the non-16pin end of the connector into the DLC socket, and the other end to the OBD I adaptor, and then tighten the captive screws.
4. Connect the other end of the adaptor to the included VCI connector.
5. To supply power to OBD I adaptor from:

A. Cigarette Lighter Cable: Connect one end of the cigarette lighter cable to vehicle's cigarette lighter receptacle, and the other end to the power jack of OBD I adaptor.

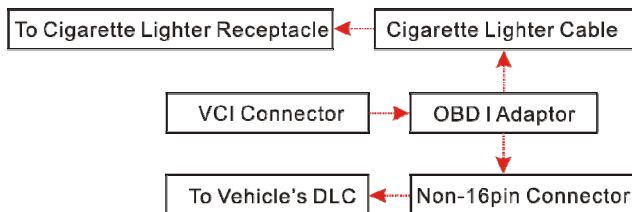

Fig. 4-13

B. Battery Clamps Cable: Connect one end of the battery clamps cable to vehicle's battery, and the other end to the power jack of OBD I adaptor.

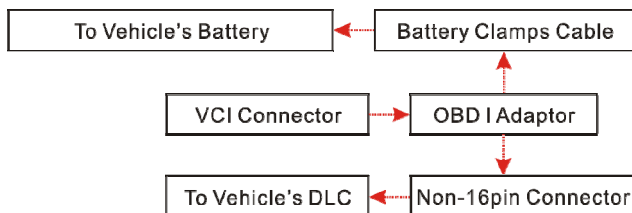

Fig. 4-14

4.3.3 Vehicle connection (For Commercial Vehicle/ Gasoline & Diesel Version)

The method used to connect the VCI module to a vehicle's DLC depends on the vehicle's configuration as follows:

A. **OBD II Vehicle Connection:** Plug one end of the diagnostic cable into the vehicle's DLC, and the other end into the diagnostic socket of the VCI module, and then tighten the captive screws.



Fig. 4-12

B. **Non-OBD II Vehicle Connection:** For vehicles with non-OBD II diagnostic socket, a non-16pin connector (adaptor cable) is required.

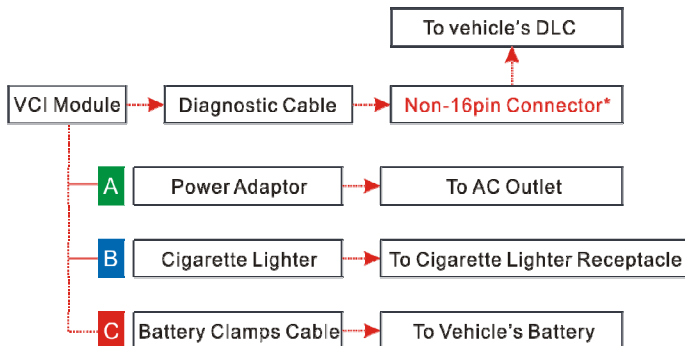

Fig. 4-13

*Notes:

- For commercial vehicles, refer to the above connection method to proceed.
- For passenger vehicles, replace the “Non-16pin connector” with “OBD I adaptor” + “non-16pin connector (for passenger vehicles)”. Other connections shall also apply.

4.5 Communication Setup (Only for Passenger Vehicle Version)

4.5.1 Pairing up via Bluetooth

There are two kinds of ways available for the tablet III to pair with the VCI connector.

- Connect one end of the USB cable (optional) to the Mini USB port of the VCI connector.
- Connect the other end to the USB port of the PC. The power indicator of the VCI connector lights up.
- Enter Bluetooth setting screen by tapping “Tablet Settings” -> “Bluetooth”, slide the Bluetooth switch to ON and the tablet starts searching for all available Bluetooth device.

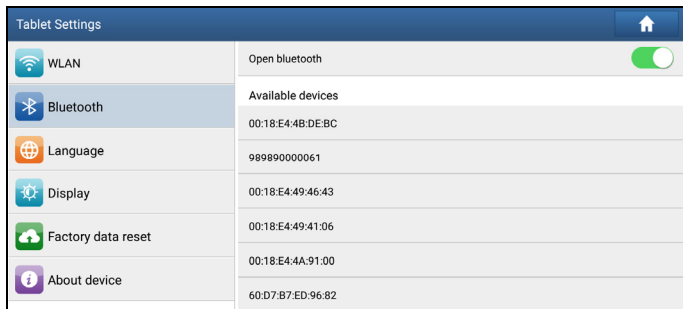

Fig. 4-15

- Tap the desired VCI connector to pair and match. By default, the Bluetooth name of the connector is 98*****00 (where ***** stands for 8 digits.).
- If the Bluetooth pair request pops up on the screen, enter the request pin code (default code: 0000 or 1234).
- Once the connector is paired with the tablet, “Paired” appears and the connector will be shown under the paired device tab.

*Note: In case no Bluetooth setting is done before diagnostic software is launched,

you can also configure it in process of vehicle diagnosis.

4.5.2 USB cable connection

The USB cable connection is a simple & quick way to establish communication between the tablet and the VCI module. After properly connecting the USB cable from the tablet to the VCI, the VCI navigation button at the bottom of the screen becomes highlighted indicating the USB connection is successful.

*Note: The USB connection provides the most stable and fastest communication. When all communication methods are applied at the same time, the X-431 PAD III system will use the USB communication as the default priority.

4.5 Communication Setup (Only for Commercial Vehicle/ Gasoline & Diesel Version)

For Commercial / Gasoline & Diesel Version, there are 3 ways available for the tablet to communicate with the VCI module: Bluetooth, Wi-Fi and USB. Choose any one of the following ways to establish communication.

4.5.1 Pairing up via Bluetooth

Refer to Chapter 4.4.3 Vehicle Connection to connect the tablet and VCI module.

1. Enter Bluetooth setting screen by tapping "Tablet Settings" -> "Bluetooth", slide the Bluetooth switch to ON and the tablet will start searching for all available Bluetooth devices.

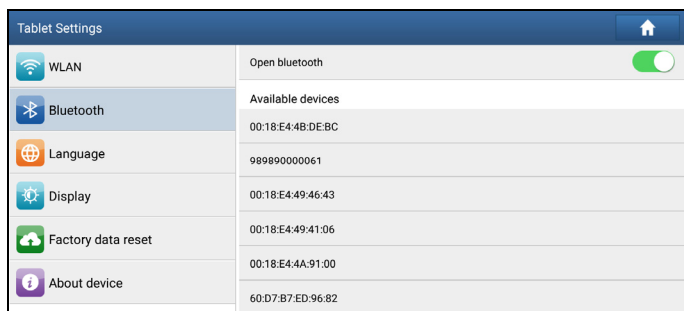

Fig. 4-14

2. Tap the desired VCI module to pair and match. By default, the Bluetooth name of the VCI module is 98*****00 (where ***** stands for 8 digits).

3. If the Bluetooth pair request pops up on the screen, input the request pin code (default code: 0000 or 1234).
4. When pairing is successfully done, the VCI module will be shown on the top of the “Paired devices” list.

*Notes:

- To make sure that the tablet has paired up with the VCI module via Bluetooth, “Personal Center”-> “VCI Management” to check whether the VCI module is paired up or not.
- If you logged in the account on another diagnostic tool and the VCI module has ever been paired up with that tool, you need to cancel pairing first before using a different tool to proceed new diagnostic session. Tap “Tablet Settings” -> “Bluetooth” -> Tap the desired VCI connector to unpair it.

In case no Bluetooth setting is done before diagnostic software is launched, you can also configure it in process of vehicle diagnosis.

4.5.2 USB cable connection

The USB cable connection is a simple & quick way to establish communication between the tablet and the VCI module. After properly connecting the USB cable from the tablet to the VCI, the VCI navigation button at the bottom of the screen becomes highlighted, and the USB LED on the VCI module illuminates solid light, indicating the USB connection is successful.

*Note: The USB connection provides the most stable and fastest communication. When all communication methods are applied at the same time, the X-431 PAD III system will use the USB communication as the default priority.

4.5.3 Wi-Fi communication

Refer to Chapter 4.4.3 to connect the tablet and VCI module.

1. After logging successfully, tap “Personal Center” -> “VCI Management”.

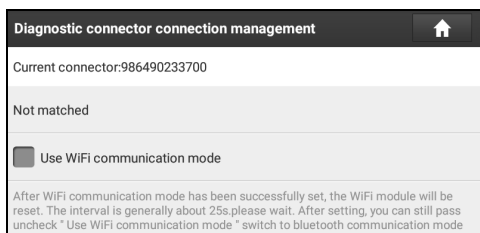

Fig. 4-16

2. Check the box “Use Wi-Fi communication mode”, the system will search for VCI module automatically. See Fig. 4-17 & Fig. 4-18.

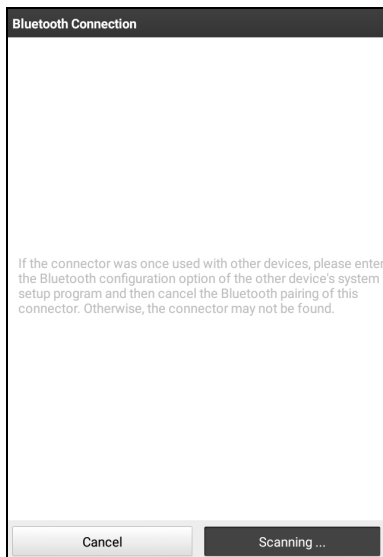

Fig. 4-17

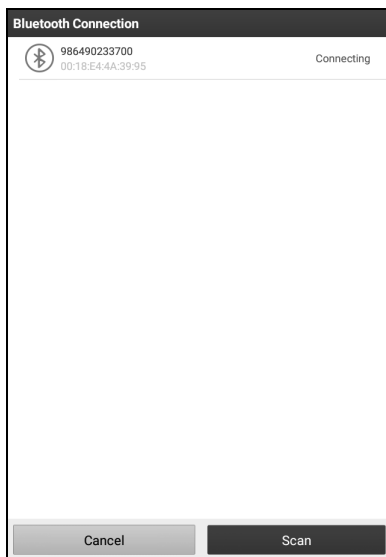

Fig. 4-18

3. Tap the desired VCI module and a pairing request similar to Fig. 4-19 will appear:

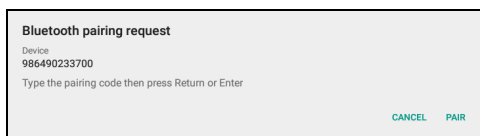

Fig. 4-19

4. Tap “PAIR” to start pairing. Once the pairing is successfully done, the screen displays:

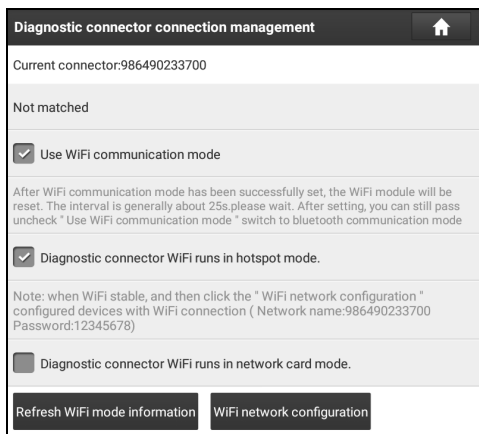

Fig. 4-20

5. There are two Wi-Fi communication modes available for the VCI module.

- Work as Wi-Fi hotspot: Once enabled, the VCI module and then tablet automatically connect and form a LAN network to make communication. In this case, the tablet cannot surf the Internet.
- Work as network adaptor: Once enabled, a Wi-Fi connection dialog box appears:

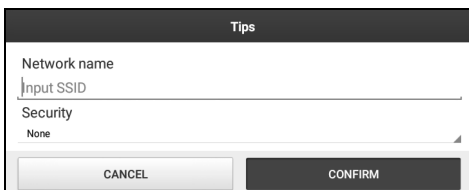

Fig. 4-21

Input the Wi-Fi network name and access password (if the network is encrypted) until it is properly connected. In this case, the tablet can surf the Internet and communicate with the VCI module.

5 Diagnosis

5.1 Intelligent Diagnosis (AutoDetect)

Through simple Bluetooth communication between the tablet and VCI device, you can easily get the VIN (Vehicle Identification Number) information of the currently identified vehicle. Once the VIN is successfully identified, the system will retrieve it from the remote server and then guide you to vehicle information page without performing the step-by-step manual menu selection.

The vehicle information page lists all historical diagnostic records of the vehicle, which lets the technician have a total command of the vehicle faults. In addition, a quick dial to local diagnosis and diagnostic function are also available on this page for reducing the roundabout time and increasing productivity.

*Notes:

- Before using this function, please make sure the VCI device is properly connected to the vehicle's DLC. For detailed connection, see Chapter 4.3.3.
- A stable network connection is required for this function.

Follow the steps below to proceed.

1. Tap "Diagnose" on the Diagnostics function module and tap "AutoDetect" to enter Fig. 5-1.

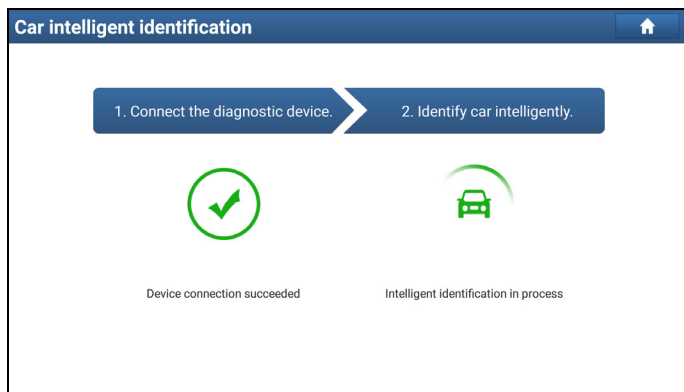

Fig. 5-1

*Note: If the VCI connector is not paired up with the tablet before doing this step, a

prompt message box will appear:

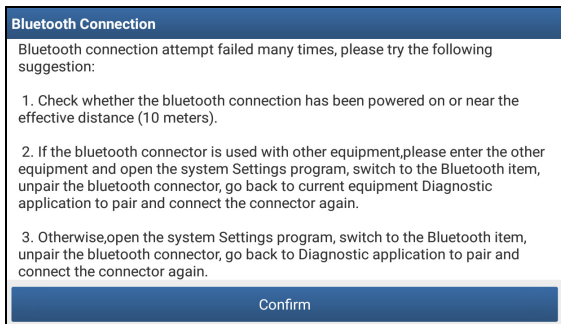

Fig. 5-2

Check all the possible reasons of Bluetooth connection failure carefully, and then tap "Confirm".

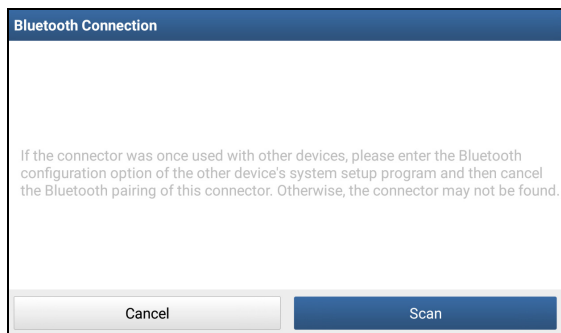

Fig. 5-3

If the VCI connector was once used with other devices, you need to cancel the pairing of the connector first via either one of the following ways:

- Tap "Tablet Settings" -> "Bluetooth" -> Choose the desired VCI connector from the Paired list. Tap "⚙️", and then tap "FORGET" to unpair it.
- Tap "Settings" -> "VCI Management" -> Tap "Deactivate matching".

Tap "Scan" to start searching for the VCI connector and pairing up with it.

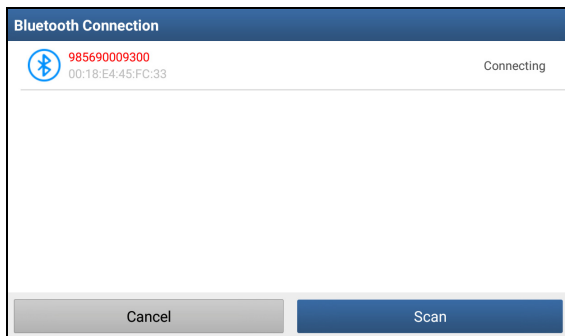

Fig. 5-4

2. After pairing is complete, the handset starts reading the vehicle VIN.
- A. If the VIN can be found from the remote server database, a screen similar to Fig. 5-5 displays:

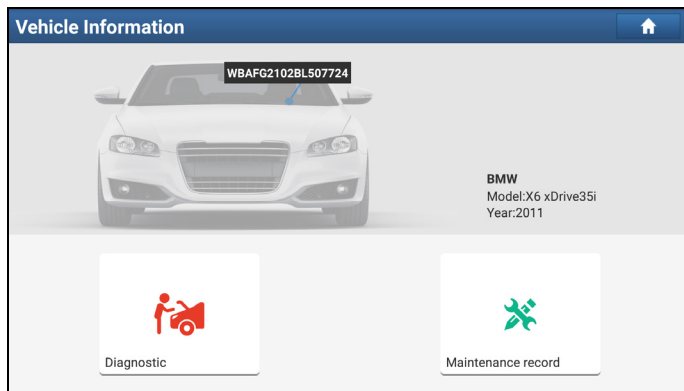

Fig. 5-5

- Tap “Diagnostic” to start a new diagnostic session.
- Tap “Maintenance record” to view its historical repair record. If there are records available, it will be listed on the screen in sequence of date. If no records exist, the screen will show “No Record”.

| Maintenance record | | | | ↑ |
|---|---------------------------------|------------------|----------|--------------|
| 2017 10/11 | Number of diagnostic systems:1 | Number of DTCs:0 | 11:43:13 | View record |
| | Number of diagnostic systems:34 | Number of DTCs:2 | 09:12:23 | View record |
| 2017 09/30 | Number of diagnostic systems:34 | Number of DTCs:2 | 14:51:40 | View record |
| 2017 09/29 | Number of diagnostic systems:34 | Number of DTCs:2 | 16:53:05 | View record |
| ■BM090K BMW X6 xDrive35i 2011 VIN WBAFG2102BL507724 | | | | Quick access |

Fig. 5-6

- Tap “View record” to view the details of the current diagnostic report.
- To perform other functions, tap “Quick access” to directly go to the function selection screen. Choose the desired one to start a new diagnostic session.

B. If the handset failed to access the VIN information, the screen will display as below:

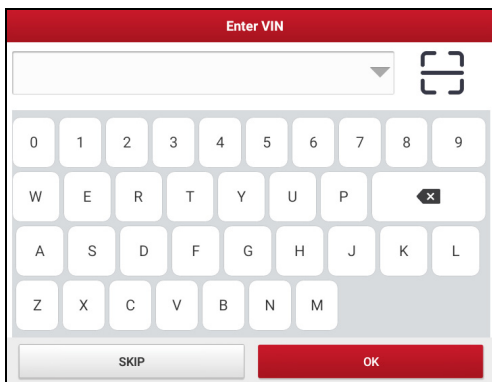



Fig. 5-7

In this mode, you need to input the VIN manually or tap  to scan it.

- 1) Tap  to launch the VIN recognition module.

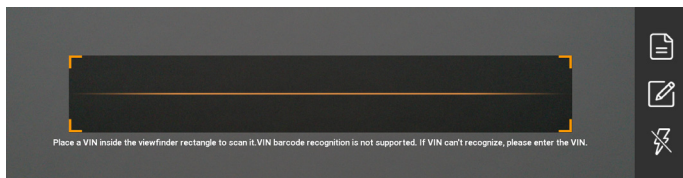





Fig. 5-8

Place the VIN inside the viewfinder rectangle to scan it. The most recognizable location for this number is in the top left corner on the vehicle's dashboard. Other locations include the driver's door or post, and the firewall under the hood.

- If you have scanned the VIN of the vehicle, tap  to choose it from the record list.
- In case the handset failed to detect it, tap  to enter it manually.
- To turn the flash on, tap .

After scanning, the screen automatically displays the result.

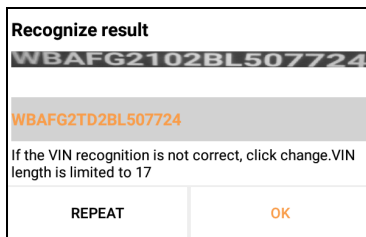

Fig. 5-9

- If the VIN scanned is incorrect, tap the result field to modify it and then tap "OK". If the VIN exists on the remote server, the system will enter the vehicle information screen. See Fig. 5-5.
 - To scan it again, tap "REPEAT".
- 2) Input the VIN, and tap "OK", the system will automatically identify the vehicle model and directly navigate to the vehicle information page.

In general, vehicle identification numbers are standardized - all contain 17 characters. VIN characters may be capital letters A through Z and numbers 1 through 0; however, the letters I, O and Q are never used in order to avoid mistakes of misreading. No signs or spaces are allowed in the VIN.

Tap “SKIP” to go to Diagnostics main menu screen.

5.2 Local Diagnosis

Tap “Local Diagnosis” to enter the vehicle selection page.

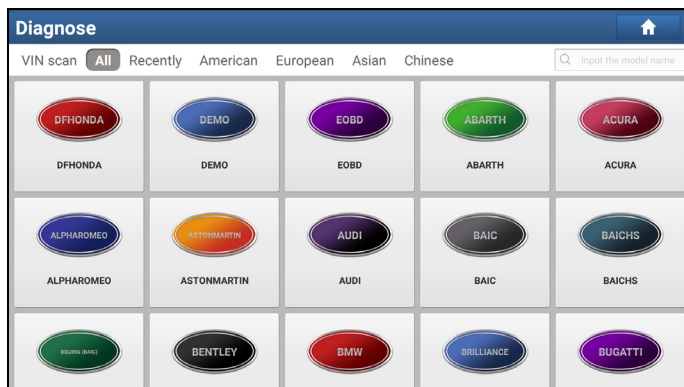

Fig. 5-10

2 approaches are provided for you to access the vehicle diagnostic software. Choose any one of the following ways:

1. VINSCAN enables you to access it more quickly.

In this case, automatic scan (OBD VIN) and manual input (INPUT VIN) are available.

In Fig. 5-10, tap “VINScan”, the screen displays as follows:

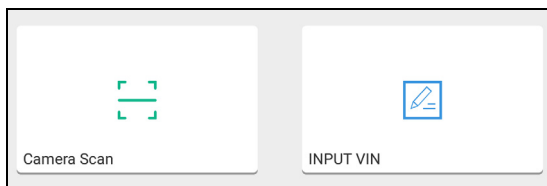

Fig. 5-11

A. Camera Scan: In this mode, the VCI connector should be plugged into the vehicle's DLC first, and then a Bluetooth communication should be established between X-431 PAD III and the vehicle.

Tap “Camera Scan”, a screen similar to the following appears:

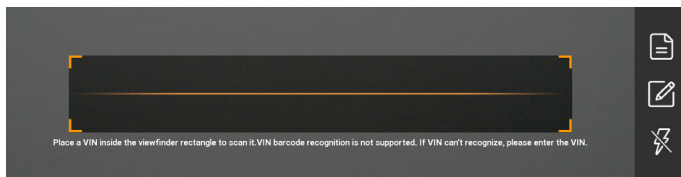





Fig. 5-12

Place the VIN inside the viewfinder rectangle to scan it. The most recognizable location for this number is in the top left corner on the vehicle’s dashboard. Other locations include the driver’s door or post, and the firewall under the hood.

- If you have scanned the VIN of the vehicle, tap  to choose it from the record list.
- In case the handset failed to recognize it, tap  to enter it manually.
- To turn the flash on, tap .

Once the test vehicle is successfully identified, X-431 PAD III will jump to the function selection page directly.

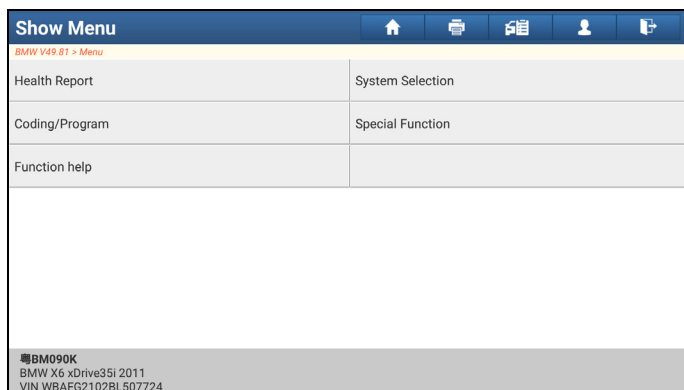

Fig. 5-13

Tap the desired option to perform the corresponding function.

*Note: Before using this function, the corresponding diagnostic software and Auto search file need to be downloaded on your tool first while downloading the diagnostic

software.

B. INPUT VIN: In this mode, you need to input the VIN manually. In general, vehicle identification numbers are standardized - all contain 17 characters. VIN characters may be capital letters A through Z and numbers 1 through 0; however, the letters I, O and Q are never used in order to avoid mistakes of misreading. No signs or spaces are allowed in the VIN.

Tap “INPUT VIN” and a screen similar to Fig. 5-14 will appear:

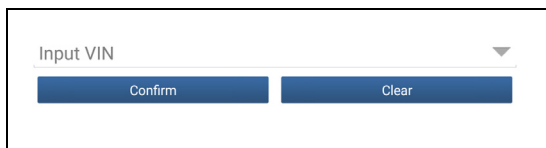

Fig. 5-14

Input the VIN, and tap “Confirm”, the system will automatically identify the vehicle model and directly navigate to the function selection page.

2. Tap a corresponding diagnostic software logo, and then follow the on-screen instruction to access the diagnostic software.

Take Demo as an example to demonstrate how to diagnose a vehicle.

1). **Select diagnostic software version:** Tap the “DEMO” to go to Step 2. (*Note: If more than one version is available on this handset, it will be listed on the screen.)

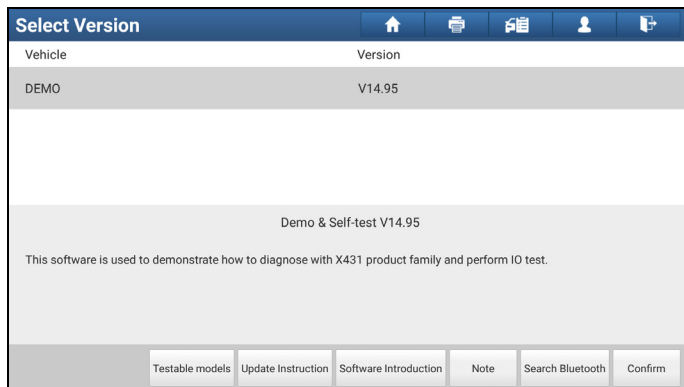

Fig. 5-15

On-screen Buttons:

Testable models: Tap to view the vehicle models that the current diagnostic software covers.

Update instruction: Tap to view the optimized items and enhancements.

Software introduction: Tap to check the software function list.

Note: Tap to read some precautions on using the current diagnostic software.

Search Bluetooth: Tap to search for the available VCI Bluetooth connector.

*Notes:

- No Bluetooth connection is required for DEMO program.
- If a vehicle is tested and no Bluetooth connection is made before diagnosis, tap “Search Bluetooth”, a dialog box similar to the following appears:

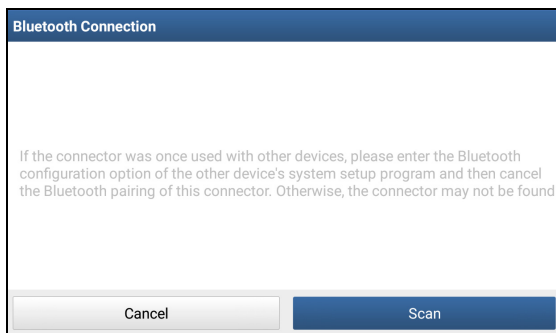

Fig. 5-16

Tap “Scan” to start searching for the VCI connector. Once it is found, tap it to start pairing.

If the X-431 PAD III handset has paired with the VCI connector, it will enter Step 2 directly.

Confirm: Tap it to go to next step.

2). **Select test item:** Select the desired test item to proceed.

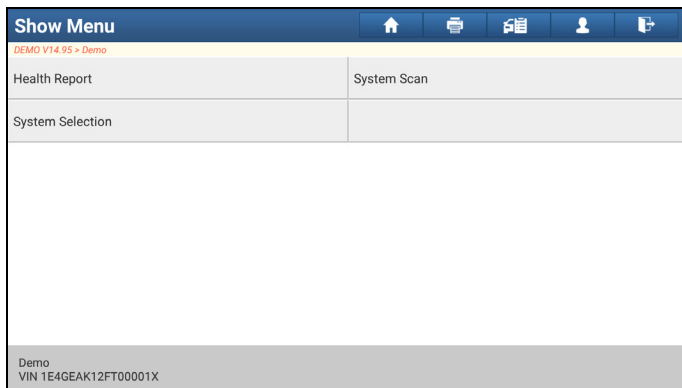

Fig. 5-17

5.2.1 Health Report (Quick Test)

This function varies from vehicle to vehicle. It enables you to quickly access all the electronic control units of the vehicle and generate a detailed report about vehicle health.

Tap “Health Report”, the system start scanning the ECUs and the screen displays as follows:

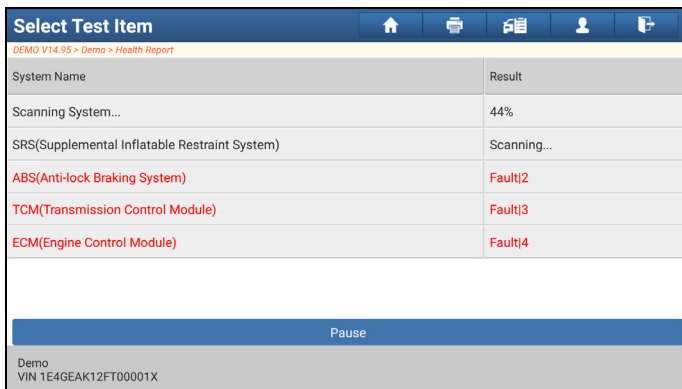

Fig. 5-18

(To stop the system scanning, tap “Pause”.)

Once the scanning is complete, a screen similar to the following appears:

| System Name | Result |
|---|----------|
| ECM(Engine Control Module) | Fault(4) |
| TCM(Transmission Control Module) | Fault(3) |
| ABS(Anti-lock Braking System) | Fault(2) |
| SRS(Supplemental Inflatable Restraint System) | Fault(3) |
| BCM(Body Control Module) | Fault(3) |
| IMM(Immobilizer) | Fault(3) |
| BMS(Battery Manager System) | OK |

Clear DTC Fault Report

Demo
VIN 1E4GEAK12FT00001X

Fig. 5-19

In Fig. 5-19, the tested system with fault code appears in red and the system with OK displays in black (normally).

On-screen Buttons:

Clear DTC: Tap to clear the existing diagnostic trouble codes.

Fault Report: Tap to view the health report in details.

| System | State |
|---|----------------|
| ECM(Engine Control Module) | Abnormal (4) |
| TCM(Transmission Control Module) | Abnormal (3) |
| ABS(Anti-lock Braking System) | Abnormal (2) |
| SRS(Supplemental Inflatable Restraint System) | Abnormal (3) |
| BCM(Body Control Module) | Abnormal (3) |
| IMM(Immobilizer) | Abnormal (3) |

Demo
VIN 1E4GEAK12FT00001X

Search Report Help

Fig. 5-20

On-screen Buttons:

Search: Highlight a certain DTC item, and then tap it to launch the browser to search for more detailed information about the selected DTC online.

Report: To save the current data in text format.

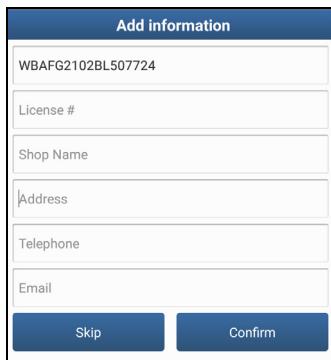

Fig. 5-21

Input the required information, and then tap “Confirm” to save it.

Alternatively you can also set the workshop information in “Personal Center” -> “Settings” -> “Print Information”. Once you configured the information, it will be automatically generated every time you saved the diagnostic report. All vehicle and workshop information will be appended to the diagnostic report.

To skip the workshop information, tap “Skip” to go to the next step.

All reports are saved under the tab “Diagnostic Report” in “My Report” from “Personal Center” menu. For details on report operations, please refer to Chapter 14.1 “My Report”.

5.2.2 System Scan

This option allows you to quickly scan which systems are installed on the vehicle.

In Fig. 5-17, tap “System Scan”, the system start scanning the systems. Once the scanning is complete, the screen will display the result. See Fig. 5-22.

| Select Test Item | |
|---|----------|
| DEMO V14.95 > Demo > System Scan | |
| System Name | Result |
| ECM(Engine Control Module) | Equipped |
| TCM(Transmission Control Module) | Equipped |
| ABS(Anti-lock Braking System) | Equipped |
| SRS(Supplemental Inflatable Restraint System) | Equipped |
| BCM(Body Control Module) | Equipped |
| IMM(Immobilizer) | Equipped |
| BMS(Battery Manager System) | Equipped |
| TPMS(Tire Pressure Monitoring System) | Equipped |
| Demo VIN 1E4GEAK12FT00001X | |

Fig. 5-22

Tap the desired system to advance to the test function selection page. For detailed operations on test function, please refer to Chapter 5.2.3.

5.2.3 System Selection

This option allows you manually select the test system and function step by step. In Fig. 5-17, tap “System Selection”, the screen displays as follows:

| Show Menu | |
|---------------------------------------|---|
| DEMO V14.95 > Demo > System Selection | |
| ECM(Engine Control Module) | TCM(Transmission Control Module) |
| ABS(Anti-lock Braking System) | SRS(Supplemental Inflatable Restraint System) |
| BCM(Body Control Module) | IMM(Immobilizer) |
| BMS(Battery Manager System) | TPMS(Tire Pressure Monitoring System) |
| SAS(Steering Angle System) | |

Fig. 5-23

Swipe the screen from the bottom to view the vehicle system on the next page. Tap the desired system (take “ECM” for example) to jump to the test function page.

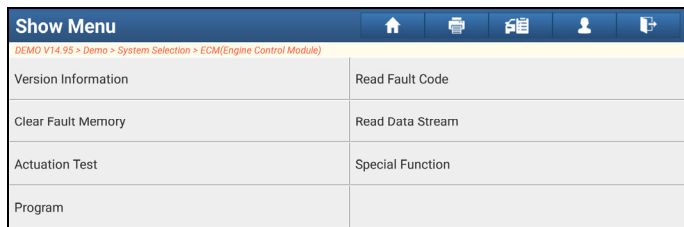

Fig. 5-24

*Note: Different vehicle has different diagnostic menus.

A. Version Information

This function is used to read the version information of system mode, vehicle VIN, software and ECU.

In Fig. 5-24, tap “Version Information”, the screen displays as Fig. 5-25.

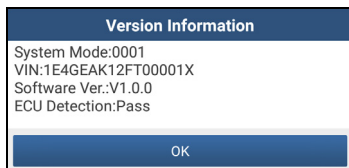

Fig. 5-25

Tap “OK” to confirm and exit.

B. Read Fault Code

This function displays the detailed information of DTC records retrieved from the vehicle’s control system.

In Fig. 5-24, tap “Read DTC”, the screen will display the diagnostic result.

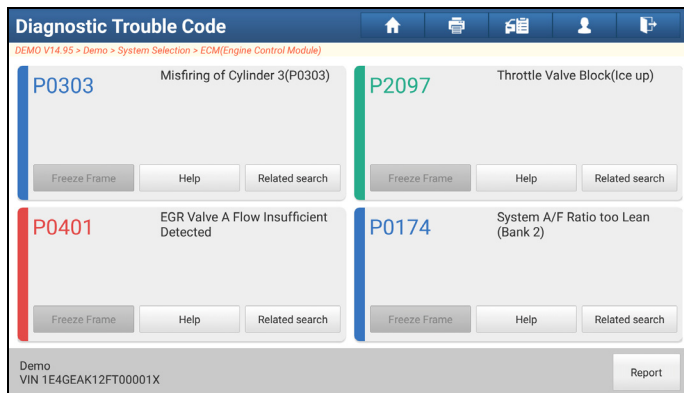

Fig. 5-26

On-screen Buttons:

Freeze Frame: When an emission-related fault occurs, certain vehicle conditions are recorded by the on-board computer. This information is referred to as freeze frame data. Freeze frame data includes a snapshot of critical parameter values at the time the DTC is set.

Help: Tap to view the help information.

Related Search: Tap it to search for more information about the current DTC online.

Report: To save the current data in text format. All reports are saved under the tab "Diagnostic Report" in "My Report" from "Personal Center" menu. For details on report operations, please refer to Chapter 15.1 "My Report".

C. Clear Fault Memory

After reading the retrieved codes from the vehicle and certain repairs have been carried out, you can use this function to erase the codes from the vehicle. Before performing this function, please be sure the vehicle's ignition key is in the ON position with the engine off.

In Fig. 5-24, tap "Clear Fault Memory", a confirmation dialog box pops up on the screen.

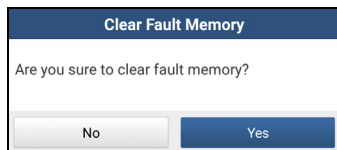

Fig. 5-27

Tap "Yes", the system will automatically delete the currently existing trouble code.

*Note: The trouble code will not disappear until the trouble was completely cleared.

D. Read Data Stream

This option retrieves and displays live data and parameters from the vehicle's ECU.

In Fig. 5-24, tap "Read Data Stream", the system will display data stream items.

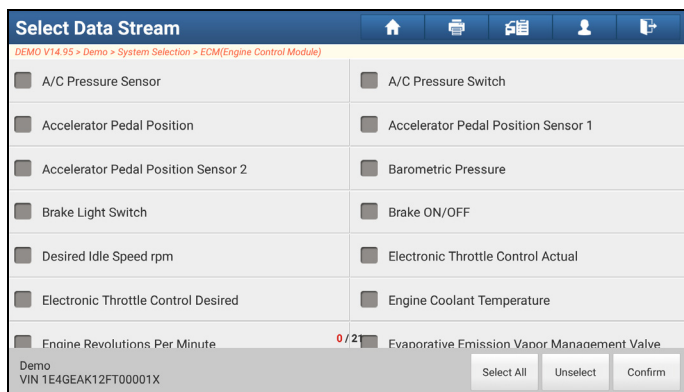

Fig. 5-28

On-screen Buttons:

Select All: Tap it to select all items of the current page. To select certain data stream item, just check the box before the item name.

Unselect: Tap it to deselect all data stream items.

Confirm: Tap it to confirm and jump to the next step.

After selecting the desired items, tap "Confirm" to enter the data stream reading page.

| Data Stream | | | | |
|-------------------------------------|-----------|----------------|--------|-------------|
| Name | Value | Standard value | Unit | |
| A/C Pressure Sensor | 2206.40 | 0-1000 | Kpa | |
| A/C Pressure Switch | Open (OK) | | | |
| Accelerator Pedal Position | 62.75 | 0-100 | % | |
| Accelerator Pedal Position Sensor 1 | 40.43 | 0-5 | V | |
| Accelerator Pedal Position Sensor 2 | 40.43 | 0-10 | V | |
| Barometric Pressure | 114.31 | 80-110 | Kpa | (1 / 3) |
| Demo VIN 1E4GEAK12FT00001X | | Combine | Report | Record Help |

Fig. 5-29

Notes:

1. If the value of the data stream item is out of the range of the standard (reference) value, the whole line will display in red. If it complies with the reference value, it displays in blue (normal mode).
2. The indicator 1/X shown on the bottom of the screen stands for the current page/total page number. Swipe the screen from the right/left to advance/return to the next/previous page.

There are 3 types of display modes available for data viewing, allowing you to view various types of parameters in the most suitable way.

- ✓ **Value** – this is the default mode which displays the parameters in texts and shows in list format.
- ✓ **Graph** – displays the parameters in waveform graphs.
- ✓ **Combine** – this option is mostly used in graph merge status for data comparison. In this case, different items are marked in different colors.

On-screen Buttons:

Combine: This option is mostly used in graph merge status for data comparison. In this case, different items are marked in different colors. Tap it to select the desired items, and then tap “Confirm” to view the merged items in graph. See Fig. 5-30 & Fig. 5-31.

| Data Stream | | | | |
|---|-----------|----------------|------|-------------|
| DEMO V14.95 > Demo > System Selection > ECM(Engine Control Module) | | | | |
| Name | Value | Standard value | Unit | |
| <input checked="" type="checkbox"/> A/C Pressure Sensor | 2316.72 | 0-1000 | Kpa | |
| <input type="checkbox"/> A/C Pressure Switch | Open (OK) | | | |
| <input checked="" type="checkbox"/> Accelerator Pedal Position | 65.88 | 0-100 | % | |
| <input checked="" type="checkbox"/> Accelerator Pedal Position Sensor 1 | 42.43 | 0-5 | V | |
| <input checked="" type="checkbox"/> Accelerator Pedal Position Sensor 2 | 42.43 | 0-10 | V | |
| <input type="checkbox"/> Barometric Pressure | 117.69 | 80-110 | Kpa | (1 / 3) |

Demo
VIN 1E4GEAK12FT00001X

Confirm Back

Fig. 5-30



Fig. 5-31

Report: To save the current data in text format. All reports are saved under the tab “Diagnostic Report” in “My Report” from “Personal Center” menu. For details on report operations, please refer to Chapter 15.1 “My Report”.

Record: Tap to start recording diagnostic data for future playback and analysis. The saved file follows the naming rule: It begins with vehicle type, and then the record starting time and ends with .x431 (To differentiate between files, please configure the accurate system time). The file is stored in “My Report” under “Personal Center” menu.

Help: Tap to view the help information.

Graph: Tap it to view the waveform.



Fig. 5-32

E. Actuation Test

This option is used to access vehicle-specific subsystem and component tests. Available test vary by vehicle manufacturer, year, and model.

During the actuation test, the X-431 PAD III handset outputs commands to the ECU in order to drive the actuators, and then determines the integrity of the system or parts by reading the ECU data, or by monitoring the operation of the actuators, such as switching a injector between two operating states.

In Fig. 5-24, tap "Actuation Test", the system will display as follows:

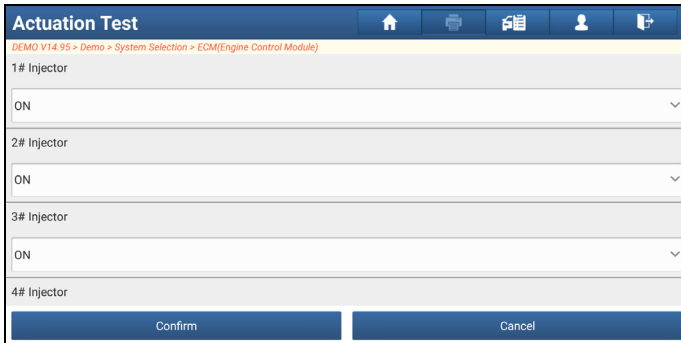

Fig. 5-33

Simply follow the on-screen instructions and make appropriate selections to complete the test. Each time when an operation is successfully executed, “Completed” displays.

5.3 Remote Diagnosis

This option aims to help repair shops or technicians launch instant messaging and remote diagnosis, making the repair job getting fixed faster.

Tap “Remote Diagnosis” on the Home screen, the screen appears blank by default.

5.3.1 Interface layout

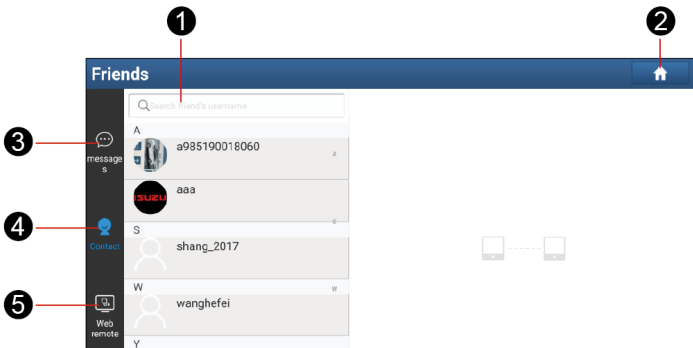

Fig. 5-34

| | | |
|---|-------------------|--|
| 1 | Search bar | Directly input the username of the X-431 PAD III to start searching, and then tap the desired one to add it into your friend list. |
| 2 | Home button | Tap it to navigate to the Home screen. |
| 3 | Message tab | Once an incoming message reaches, a red dot will appear on the upper right corner of the tab. |
| 4 | Contact tab | Tap to enter the friend list. |
| 5 | WEB Remote switch | Tap to slide the switch to ON, the X-431 PAD III keeps online and becomes visible on the web client. In this case, inform the technician of your product S/N, and he/she will control your X-431 PAD III remotely. |

5.3.2 Add friends

Tap "Contact" to enter the contact page. By default it appears blank.

In the search bar, input the partner's username and tap "Search" button next to the search bar to starts searching from Launch's golo business database.

The partner must be the users who have registered their Launch's diagnostic tools. They may be the following:

- Workshop
- Technician
- golo users

Once the result matches the keyword, a screen similar to the following will appear:

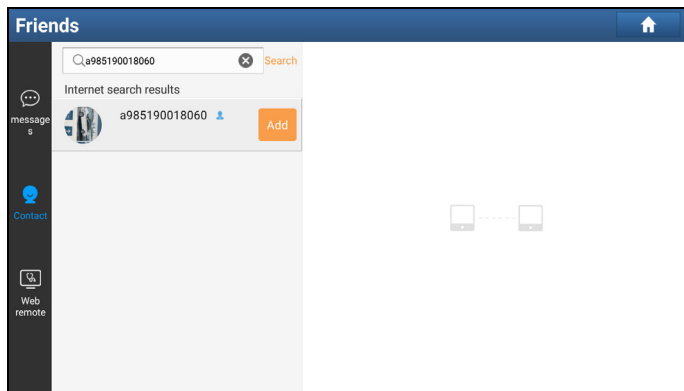

Fig. 5-35

Tap “Add”, a dialog box pops up:

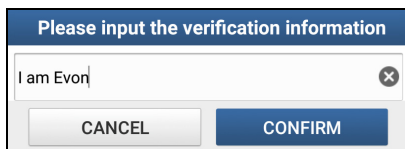

Fig. 5-36

Tap “CONFIRM” to send your request.

Once the partner receives the request, a beep will sound. Tap the “Message” tab:

- Once the partner agreed your request, he/she will automatically be listed in the Contact tab.
- If a technician sent you a friend request, you can tap “Agree” to confirm and his/her name will appear in the friend list (Contact). Or tap “Ignore” to ignore this request.

5.3.3 Start instant messaging

*Note: The I/M (Instant Messaging) function is open to all users who had Launch’s diagnostic tool equipped with this module.

After adding your friends, tap the desired one’s photo to enter a screen similar to the following:

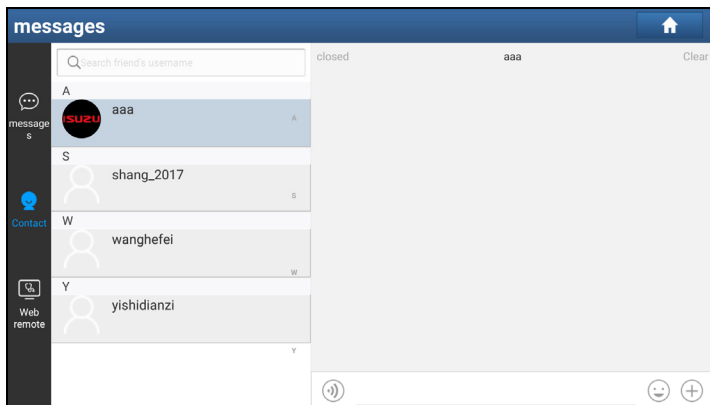





Fig. 5-37

Tap the input field and use the on-screen keyboard to enter the text message, and then tap “Send” to send it.

Tap  to send the voice message.

Tap  to send the emoji.

Tap  to call out more function options.

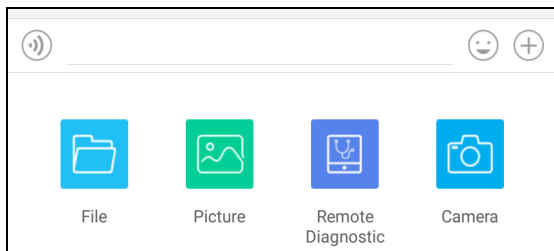

Fig. 5-38

File: Choose diagnostic reports or local files to send.

Picture: Choose screenshots or pictures to send.

Remote Diagnostic: To start a remote diagnostic session. For details, refer to Chapter 5.3.4.

Camera: Open camera to take pictures.

5.3.4 Launch remote diagnosis (Device-To-Device)

The X-431 PAD III handset is allowed to launch remote diagnosis with other diagnostic tools (including but not limited to the X-431 PAD III) of Launch family, which are equipped with this module.

* Note: Before performing this operation, please make sure the following no matter which side sends the remote request:

- Turn on the vehicle power supply.
- Throttle should be in a closed position.
- The X-431 PAD III should be properly connected to the vehicle's DLC and a successful communication is required.

In Fig. 5-38, tap "Remote Diagnostic", a pull-down menu including the following options appears:

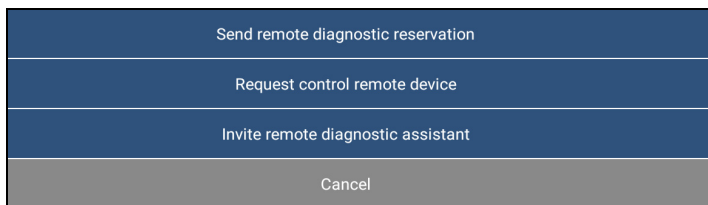

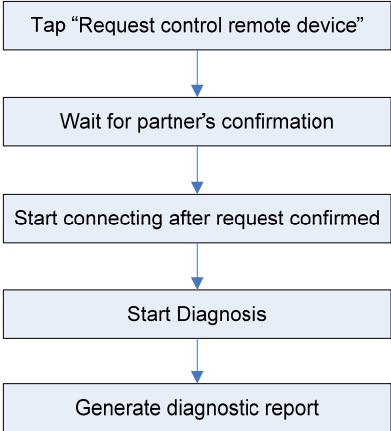

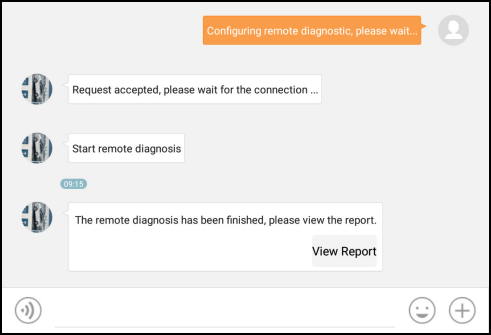

Fig. 5-39

These options are defined as follows:

| Actions | Results |
|------------------------------------|--|
| Send remote diagnostic reservation | Tap it and input the reservation title or scheduled date of the remote diagnosis, and then tap "Confirm" to send. |
| Request control remote device | Request to control the partner's device remotely to help him diagnose the vehicle. *Notes: <ul style="list-style-type: none"> • Remote diagnosis has the same diagnostic steps as manual diagnosis. • In process of remote diagnosis, tap the  button to send a voice message. • Once vehicle diagnosis is complete, a report will be |

| | |
|---|---|
| | <p>created. Input your comments on this report, and then tap “Send Report” to send it to the partner.</p>  <pre> graph TD A[Tap "Request control remote device"] --> B[Wait for partner's confirmation] B --> C[Start connecting after request confirmed] C --> D[Start Diagnosis] D --> E[Generate diagnostic report] </pre> |
| <p>Invite remote diagnostic assistant</p> | <p>If you need support, just use this option to invite a technician to perform a remote control on your tool.</p> <p>*Notes:</p> <ul style="list-style-type: none"> • Remote diagnosis has the same diagnostic steps as manual diagnosis. • In process of remote diagnosis, tap the  button to send voice message. • Once you received the report from the partner, tap “View Report” to view details. All diagnostic reports are saved under the “Remote Diagnostic Reports” tab of “My Reports” in “Personal Center”. |

| | |
|---------------|--|
| |  <pre> graph TD A[Tap "Invite remote diagnostic assistant"] --> B[Choose the desired diagnostic software] B --> C[Wait for partner's confirmation] C --> D[Start connecting after request confirmed] D --> E[Start Diagnosis] E --> F[Generate diagnostic report] </pre> |
| <p>Cancel</p> | <p>To cancel this operation.</p> |

5.3.5 Launch remote diagnosis (Device-To-PC)

Except that the remote diagnosis can be done between different Launch's diagnostic tools that come loaded with the module, user also can ask for remote control from PC client technician.

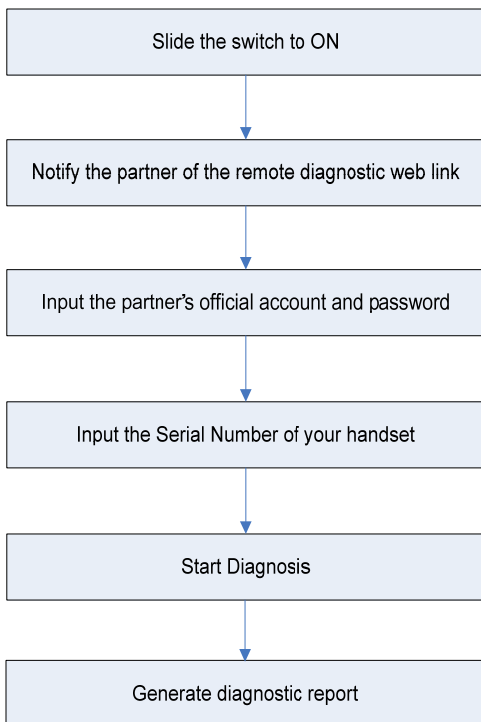

Fig. 5-40

Tap the “Web Remote” tab, the screen displays as follows:

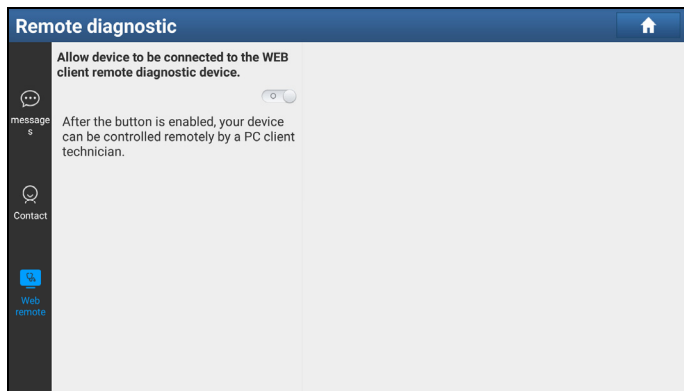

Fig. 5-41

1. Slide the switch “Allow device to be connected to the WEB client remote diagnostic device” to ON so that the partner can find and access to this device while using the PC.
2. Notify the partner of the PC client website <http://remote.x431.com/cn/>. When the partner opens the link, the PC displays as below:

*Note: Before processing remote diagnosis, please make sure the tablet is properly connected to the vehicle.

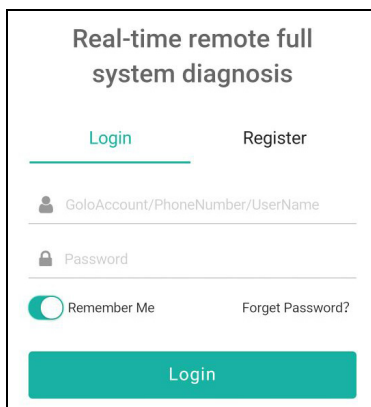

Fig. 5-42

3. Tell the partner to input his own official technician account and password, and then tap “Login” to navigate to the following figure.

Remote diagnosis

Serial Number
Locate the car to be diagnosed according to golo/AIT serial number

License Plate Number
Locate the car to be diagnosed according to the car owner's license plate number

Phone Number
Locate the car to be diagnosed according to the car owner's phone number

972290000223

Start remote diagnosis

Tips: Before starting remote diagnosis, confirm the car owner's car information and condition

Fig. 5-43

4. Tell the partner to check the box “Serial number” and enter the Serial Number provided by you, and then tap “Start remote diagnosis”.
5. A popup displays to ask for your confirmation to allow remote control on your device.
6. Tap “Allow” to accept, or tap “Deny” to reject.

In process of remote diagnosis, please note the following things:

- 1) You are not suggested to execute any actions.
- 2) The partner is not allowed to save any diagnostic reports or records on your handset.

The operations in remote diagnosis are same as those in local diagnosis. Once the session is complete, a remote diagnostic report will be automatically generated.

5.4 How to View Diagnostic History?

Generally once a vehicle diagnosis is performed, X-431 PAD III will record the

every details of diagnostic process. The History function provides direct access to the previously tested vehicles and users can resume from the last operation, without the necessity of starting from scratch.

Tap “Diagnostic History” on the Home screen, all diagnostic records will be listed on the screen in date sequence.

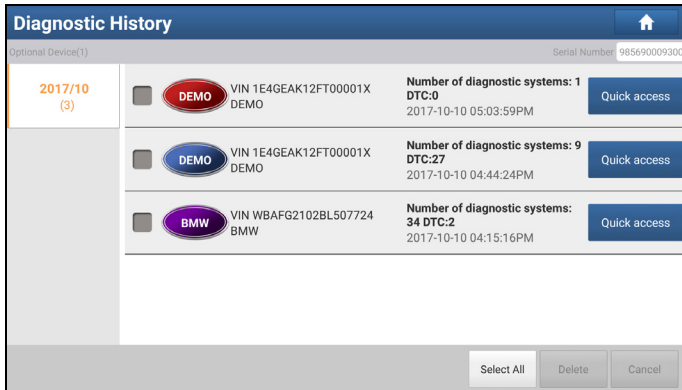

Fig. 5-44

- Tap certain vehicle model to view the details of the last diagnostic report.
- To delete certain diagnostic history, select it and then tap “Delete”. To delete all historical records, tap “Select All” and then tap “Delete”.
- Tap “Quick access” to directly navigate to the function selection page of last diagnostic operation. Choose the desired option to proceed.

5.5 How to Feedback Diagnostic Logs?

This item allows you to feedback your diagnostic problems to us for analysis and troubleshooting.

Tap “Feedback”, a pop-up message will appear:

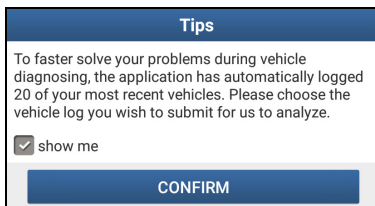

Fig. 5-45

Tap “CONFIRM” to choose the vehicle diagnostic record page.

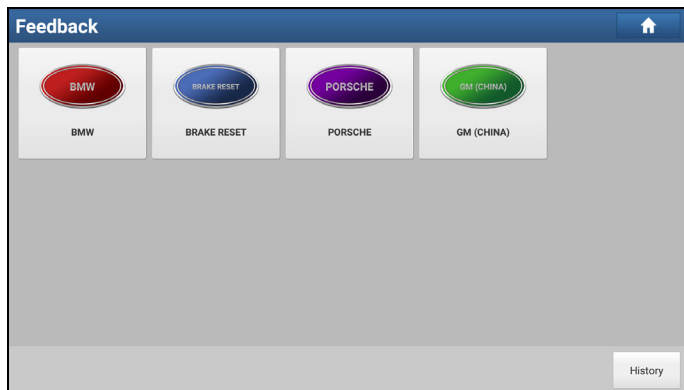

Fig. 5-46

A). Tap the desired vehicle to enter the diagnostic log selection page.

| Feedback ↑ | | |
|---|---------------------------------|---------------------|
| Vehicle | File Name | Date |
| <input type="checkbox"/> BMW | 985690009300_BMW_20171010170606 | 2017-10-10 17:06:06 |
| <input type="checkbox"/> BMW | 985690009300_BMW_20171010170520 | 2017-10-10 17:05:20 |
| <input type="checkbox"/> BMW | 985690009300_BMW_20171010161503 | 2017-10-10 16:15:03 |
| <input type="checkbox"/> BMW | 985690009300_BMW_20171010161240 | 2017-10-10 16:12:40 |
| <input type="checkbox"/> BMW | 985690009300_BMW_20171010161025 | 2017-10-10 16:10:25 |

Fig. 5-47

Select the check box and tap “Submit”. A screen similar to the following will appear:

Feedback

Select failure type(Required)

1: This car model does not exist
 2: Failed to enter the system
 3: Fault code execution
 4: Data stream problem

5: Actuation test problem
 6: Special function problem
 7: Others problem

Problem description (Required)

Input vehicle information (car model, model year, VIN and detailed description)

Phone/E-mail (we will contact with you)

Fig. 5-48

Choose the failure type and fill in the detailed failure description in the blank text box and telephone or email address. After inputting, tap “Submit Result” to send it to us.

B). Tap “History”, the diagnostic logs marked with different color indicate the process status of the diagnostic feedback. Green/Red/Blue means the diagnostic feedback is fixed/pending/in process respectively.

6 Special (Reset) Function (Only for Passenger Vehicle/Gasoline & Diesel Version)

In addition to amazing & powerful diagnostic function, X-431 PAD III also features various service functions. The most commonly performed service functions contain:

- Oil Reset Service
- Electronic Parking Brake Reset
- Steering Angle Calibration
- ABS Bleeding
- TPMS (Tire Pressure Monitor System) Reset
- Gear Learning
- IMMO Service
- Injector Coding
- Battery Maintenance System
- Diesel Particulate Filter (DPF) Regeneration
- Electronic Throttle Position Reset

There are two methods to reset service lamp: Manual reset or Auto reset. Auto reset follows the principle of sending command from the tool to vehicle's ECU to do resetting. While using manual reset, users just follow the on-screen instructions to select appropriate execution options, enter correct data or values, and perform necessary actions, the system will guide you through the complete performance for various service operations.

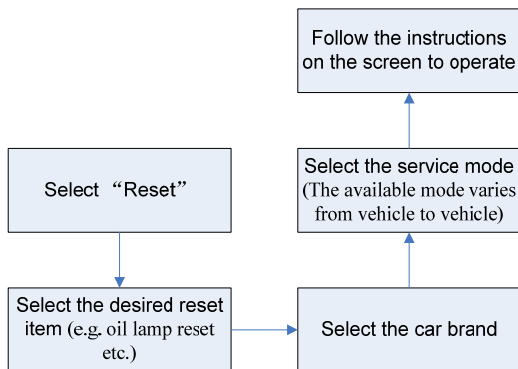

Figure 6-1

6.1 Oil Reset Service

This function allows you to perform reset for the engine oil life system, which calculates an optimal oil life change interval depending on the vehicle driving conditions and climate.

This function can be performed in the following cases:

1. If the service lamp is on, you must provide service for the car. After service, you need to reset the driving mileage or driving time so that the service lamp turns off and the system enables the new service cycle.
2. After changing engine oil or electric appliances that monitor oil life, you need to reset the service lamp.

6.2 Electronic Parking Brake Reset

1. If the brake pad wears the brake pad sense line, the brake pad sense line sends a signal sense line to the on-board computer to replace the brake pad. After replacing the brake pad, you must reset the brake pad. Otherwise, the car alarms.
2. Reset must be performed in the following cases:
 - a) The brake pad and brake pad wear sensor are replaced.
 - b) The brake pad indicator lamp is on.
 - c) The brake pad sensor circuit is short, which is recovered.
 - d) The servo motor is replaced.

6.3 Steering Angle Calibration

To reset the steering angle, first find the relative zero point position for the car to drive in straight line. Taking this position as reference, the ECU can calculate the accurate angle for left and right steering.

After replacing the steering angle position sensor, replacing steering mechanical parts (such as steering gearbox, steering column, end tie rod, steering knuckle), performing four-wheel alignment, or recovering car body, you must reset the steering angle.

6.4 ABS Bleeding

This function allows you to perform various bi-directional tests to check the operating conditions of Anti-lock Braking System (ABS).

1. When the ABS contains air, the ABS bleeding function must be performed to bleed the brake system to restore ABS brake sensitivity.
2. If the ABS computer, ABS pump, brake master cylinder, brake cylinder, brake line, or brake fluid is replaced, the ABS bleeding function must be performed to bleed the ABS.

6.5 Tire Pressure Monitor System Reset

This function allows you to quickly look up the tire sensor IDs from the vehicle's ECU, as well as to perform TPMS replacement and sensor test.

1. After the tire pressure MIL turns on and maintenance is performed, the tire pressure resetting function must be performed to reset tire pressure and turn off the tire pressure MIL.
2. Tire pressure resetting must be performed after maintenance is performed in the following cases: tire pressure is too low, tire leaks, tire pressure monitoring device is replaced or installed, tire is replaced, tire pressure sensor is damaged, and tire is replaced for the car with tire pressure monitoring function.

6.6 Gear Learning

The crankshaft position sensor learns crankshaft tooth machining tolerance and saves to the computer to more accurately diagnose engine misfires. If tooth learning is not performed for a car equipped with Delphi engine, the MIL turns on after the engine is started. The diagnostic device detects the DTC P1336 'tooth not learned'. In this case, you must use the diagnostic device to perform tooth

learning for the car. After tooth learning is successful, the MIL turns off. After the engine ECU, crankshaft position sensor, or crankshaft flywheel is replaced, or the DTC 'tooth not learned' is present, tooth learning must be performed.

6.7 IMMO Service

An immobilizer is an anti-theft mechanism that prevents a vehicle's engine from starting unless the correct ignition key or other device is present. Most new vehicles have an immobilizer as standard equipment. An important advantage of this system is that it doesn't require the car owner to activate it since it operates automatically. An immobilizer is considered as providing much more effective anti-theft protection than an audible alarm alone.

As an anti-theft device, an immobilizer disables one of the systems needed to start a car's engine, usually the ignition or the fuel supply. This is accomplished by radio frequency identification between a transponder in the ignition key and a device called a radio frequency reader in the steering column. When the key is placed in the ignition, the transponder sends a signal with a unique identification code to the reader, which relays it to a receiver in the vehicle's computer control module. If the code is correct, the computer allows the fuel supply and ignition systems to operate and start the car. If the code is incorrect or absent, the computer disables the system, and the car will be unable to start until the correct key is placed in the ignition.

To prevent the car being used by unauthorized keys, the anti-theft key matching function must be performed so that the immobilizer control system on the car identifies and authorizes remote control keys to normally use the car.

When the ignition switch key, ignition switch, combined instrument panel, ECU, BCM, or remote control battery is replaced, anti-theft key matching must be performed.

6.8 Injector Coding

Write injector actual code or rewrite code in the ECU to the injector code of the corresponding cylinder so as to more accurately control or correct cylinder injection quantity.

After the ECU or injector is replaced, injector code of each cylinder must be confirmed or re-coded so that the cylinder can better identify injectors to accurately control fuel injection.

6.9 Battery Maintenance System Reset

This function enables you to perform a resetting operation on the monitoring unit of vehicle battery, in which the original low battery fault information will be cleared and battery matching will be done.

Battery matching must be performed in the following cases:

- a) Main battery is replaced. Battery matching must be performed to clear original low battery information and prevent the related control module from detecting false information. If the related control module detects false information, it will invalidate some electric auxiliary functions, such as automatic start & stop function, sunroof without one-key trigger function, power window without automatic function.
- b) Battery monitoring sensor. Battery matching is performed to re-match the control module and motoring sensor to detect battery power usage more accurately, which can avoid an error message displaying on the instrument panel.

6.10 Diesel Particulate Filter (DPF) Regeneration

DPF regeneration is used to clear PM (Particulate Matter) from the DPF filter through continuous combustion oxidation mode (such as high temperature heating combustion, fuel additive or catalyst reduce PM ignition combustion) to stabilize the filter performance.

DPF regeneration may be performed in the following cases:

- a) The exhaust back pressure sensor is replaced.
- b) The PM trap is removed or replaced.
- c) The fuel additive nozzle is removed or replaced.
- d) The catalytic oxidizer is removed or replaced.
- e) The DPF regeneration MIL is on and maintenance is performed.
- f) The DPF regeneration control module is replaced.

6.11 Electronic Throttle Position Reset

This function enables you to make initial settings to throttle actuators and returns the “learned” values stored on ECU to the default state. Doing so can accurately control the actions of regulating throttle (or idle engine) to adjust the amount of air intake.

7 Software Update

If you did not download the software in process of product registration or a pop-up message prompting you that some new software can be updated, you may use this option to download it or keep it synchronized with the latest version.

Tap “Software Upgrade” on the Home screen to enter the update center.

| Update | | | | Serial Number 985690009300 |
|--|-----------------|----------------|----------|----------------------------|
| 16 Upgradable Software | | | | Installation package size |
| Vehicle | Current Version | Update Version | | |
| <input checked="" type="checkbox"/> HYUNDAI | | V50.12 | 7.7 MB | ▼ |
| <input checked="" type="checkbox"/> JIAO | | V13.43 | 1.6 MB | ▼ |
| <input checked="" type="checkbox"/> JMC | | V12.74 | 55.6 MB | ▼ |
| <input checked="" type="checkbox"/> LIUWELTY | | V20.41 | 5.5 MB | ▼ |
| <input checked="" type="checkbox"/> Maserati | | V10.25 | 2.7 MB | ▼ |
| <input checked="" type="checkbox"/> NISSAN/INFINITI/DFNISSAN | | V43.67 | 24.8 MB | ▼ |
| <input checked="" type="checkbox"/> PROTON | | V14.40 | 928.7 KB | ▼ |
| <input checked="" type="checkbox"/> QIRULTY | | V56.32 | 8.4 MB | ▼ |

Unselect Update Delete

Fig. 7-1

By default, all diagnostic software is selected. To deselect certain software, tap “Unselect”, and then check the box next to vehicle model. Tap “Update” to start downloading. It may take several minutes to finish it, please be patient to wait. To pause downloading, tap “Stop”. To resume it, tap “Continue”. If network connection failure occurs, tap “Retry” to try again.

Once download is finished, the software packages will be installed automatically.

8 golo Business Manager

This module is an individual business management application specially developed for repair shops. Before using it, you need to download the application and register a golo business account.

On this platform, you can provide nearby car owners with attentive service to develop new business opportunities, manage technicians and golo customers more efficiently, monitor customer's vehicle running status in real-time manner and perform remote assistance anywhere etc. It is very helpful to increase productivity and boost shop revenue.

Tap “golo” on the Home screen to enter golo business manager account. See Fig. 8-1.

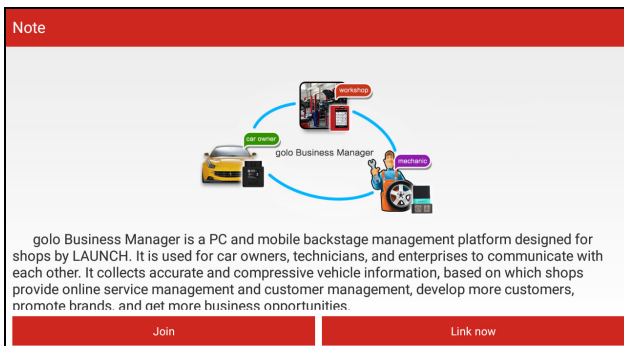

Fig. 8-1

A. If you had no golo business manager account, tap “Join” to enter a screen similar to Fig. 8-2:

Fig. 8-2

Fill in the required items:

- To upload the shop picture, tap the + logo to choose the desired photo.
- To locate company address, tap the GPS location icon to obtain it automatically.
- To define the item “Model specialized”, tap the > icon to select the vehicle models.

After entering, tap “Submit” to confirm. “Sign up successfully” will pop up and the system will jump to golo main menu screen.

B. If you have a golo business manager account, tap “Link now” to bind this tool to it.

Fig. 8-3

For more detailed operations on this module, please refer to the user manual included within this application.

9 Sensorbox (Toolbox)

9.1 Product Summary

X-431 PAD III provides an optional function of automotive sensor simulation test. "Sensor" function is specially designed to diagnose and simulate vehicle sensor faults quickly and conveniently, including "DC voltage simulation", "Fixed frequency simulation", "Predefined waveform simulation" and "Hand-painted waveform simulation".

Vehicle sensors are the signal input devices for electrical control systems, which can transform all kinds of running parameters, such as vehicle speed, coolant temperature, engine RPM, air flow, throttle opening, etc., into the electronic signal for the vehicle computer who can optimize the engine running status per the above-mentioned parameters to keep the engine working in a prime status.

Meanwhile, it integrates the functions of automobile multimeter (For detailed operations on multimeter, please refer to Chapter 10), which enables users to perform voltage, resistance and frequency test. (The function utilizes the same hardware device as the sensor module)

It features automotive sensor simulation test and multimeter test function.

Sensorbox

| Parameters | Scope |
|------------------------------------|---------|
| Precision | ±5% |
| Voltage range | -5V~+5V |
| Max output current | 70mA |
| Predefined frequency range | 0~150Hz |
| Square-wave signal pulse frequency | 0~15KHz |
| Square-wave signal duty ratio | 10%~90% |

Multimeter

| Parameters | Scope |
|------------|-------|
| Precision | ±5% |

| | | |
|-----------------|-----------------|---------------|
| Voltage test | Testing range | DC-400V~+400V |
| | Input impedance | 10Mohm |
| Resistance test | Testing range | 0~40Mohm |
| Frequency test | Testing range | 0~25KHz |
| | Input impedance | 1000Gohm |
| | Input voltage | 1~12V |

9.2 Structure & Accessories

9.2.1 Sensorbox structure

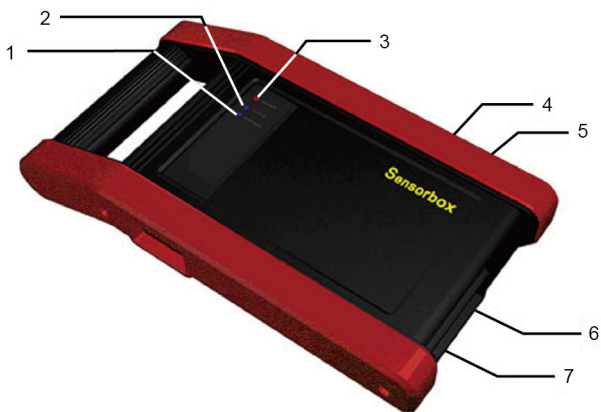

Fig. 9-1 Structural diagram of Sensorbox

Table 9-1 shows the ports and indicators for X-431 PAD III sensorbox





| No. | Name | Description |
|-----|--------------------|--|
| 1 | Data receiving LED | Indicator (green) for receiving data from the diagnostic tool. |
| 2 | Data sending LED | Indicator (green) for sending data to the diagnostic tool. |



| | | |
|---|-----------------|--|
| 3 | Power LED | It keeps steady on (red) after the sensorbox is powered on. |
| 4 | Type-B USB port | Connect the Sensorbox to the diagnostic tool with USB cable. |
| 5 | Power connector | Connect to power supply through the power adaptor. |
| 6 | COM | Common terminal of multimeter |
| 7 | VΩHz | Testing terminal of multimeter |

9.2.2 Sensorbox accessories

The sensorbox accessories include sensor test cable, probe etc. For detailed items, please see the packing list.

Below formulates the Sensorbox accessories:

| No. | Name | Picture |
|-----|-------------------|--|
| 1 | Sensor test cable |  |
| 2 | Sensor probes |  |
| 3 | USB cable |  Connects the Sensorbox and diagnostic tool so that the sampled signal can be displayed on the diagnostic tool. |
| 4 | Power adaptor |  To supply power to the Sensorbox |

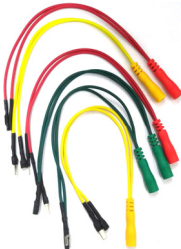
| | | |
|---|---------------------------------------|--|
| | | through connection to AC outlet. |
| 5 | Battery clamps cable |  <p>To supply power to the Sensorbox through connection to vehicle's battery.</p> |
| 6 | Electronic control converting cable 1 |  |
| 7 | Electronic control converting cable 2 |  |

9.3 Sensor Simulation

9.3.1 Connections

1. Firstly, power the tablet on.
2. Connect the B-shaped terminal of USB cable to the B-shaped port of the Sensorbox, and the other end to the USB port of the diagnostic tool.
3. Plug one end of the sensor test cable (black) into the "COM" interface of the sensorbox, and then the other end to the test probe or electronic control converting cable.
4. Connect one end of the sensor test cable (red) into the "VΩHz" interface of the sensorbox, and then the other end to the test probe or electronic control

converting cable.

*Note: Choose corresponding cables and test probes according to different terminals.

9.3.2 Simulation test

Simulation test enables users to exactly judge if the sensor is good or not to avoid replacing components blindly. For example, the trouble code indicates the fault is in water temperature sensor itself. But we need to confirm whether the fault results from water temperature sensor or the connections between ECU and sensors, or ECU itself. In this case, we can make full use of simulation test to input the signal of simulating water temperature sensor, instead of water temperature sensor, to the microcomputer. If the engine works better and the fault vanishes, the fault is in the water temperature sensor. If the fault still occurs, input the signal to the corresponding terminals of ECU. Consequently, if the fault disappears, the fault lies in the connection between water temperature sensor and ECU, otherwise, the fault exists in ECU.

After all connections are properly made (refer to Chapter 9.3.1 for details), turn the tablet on and enter the Home screen, then tap "Toolbox" -> "Sensor" to enter the test selection screen. See Fig. 9-2.

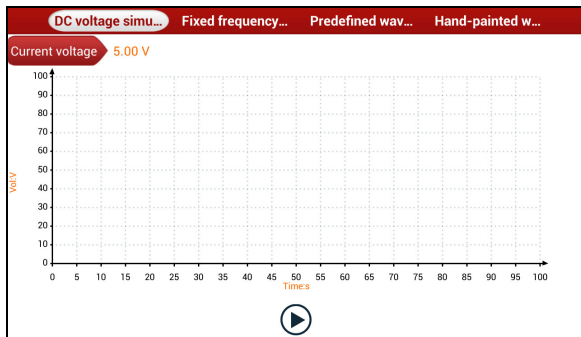



Fig. 9-2

1. DC voltage simulation

In Fig. 9-2, tap [Current voltage], then tap "+" or "-" to adjust the output voltage value. Alternatively, user can also tap edit box, then use the on-screen keyboard to input the desired value directly. After selecting or inputting the desired voltage based on the working characteristics of sensor, tap the  button, then the X-431 PAD III will begin to output the simulation voltages. Please note the red

probe is the output terminal of simulation voltage.

2. Fixed frequency simulation

This option enables you to simulate the square wave signal of pulse frequency of 0.1 ~ 15 kHz, amplitude range of -5V ~ +5V and duty cycle 10% ~ 90%.

In Fig. 9-2, tap “Fixed frequency simulation” to enter a screen similar to Fig. 9-3.

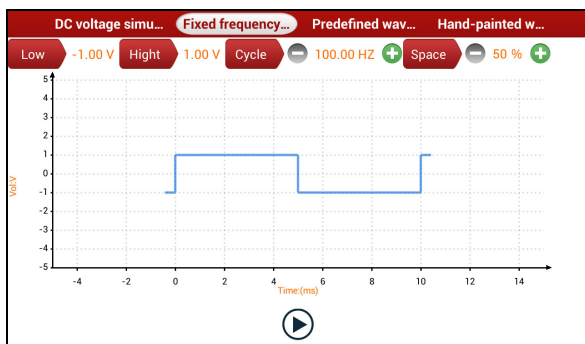



Fig. 9-3

Tap the setting option tab, then tap “+” or “-” to adjust the output. After setting, tap  to perform the test.

3. Predefined waveform simulation

X-431 PAD III provides some common sensor waveforms which have been predefined to facilitate users to simulate sensor signals. As long as you call out the predefined waveform, then tap  to start simulating output of corresponding sensor waveform and no more parameter settings of simulation waveform are required.

In Fig. 9-3, tap “Predefined waveform simulation” to enter the screen shown as Fig. 9-4.

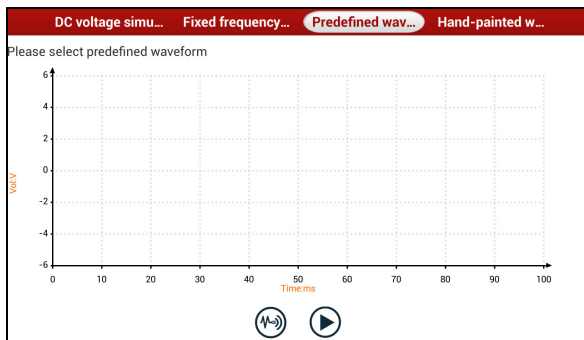



Fig. 9-4

Here, tap  button, a screen similar to Fig. 9-5 will appear.

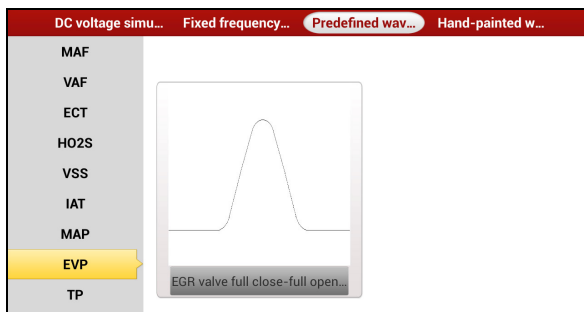

Fig. 9-5

In Fig. 9-5, the left setting column stands for sensor types and the right area displays waveform. The sensor types are explained as below:

ECT: Coolant Temperature Sensor

EVP: EGR Valve Position Sensor

HO2S: Heated Oxygen Sensor

IAT: Intake Air Temperature Sensor

MAF: Mass Air Flow Sensor

MAP: Manifold Absolute Pressure Sensor

TP: Throttle Position Sensor

VAF: Volume Air Flow Sensor

VSS: Vehicle Speed Sensor

For example, tap “ECT” – “Warm (NTC Thermistor)” in Fig. 9-5, the right screen will display the waveform of the sensor.

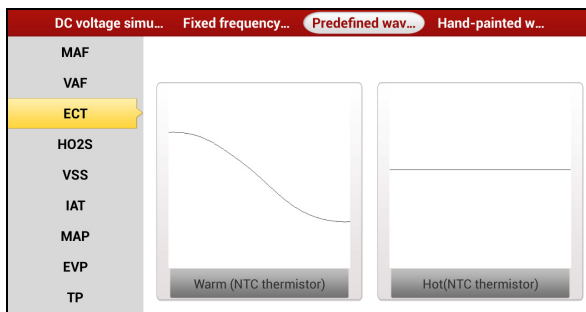

Fig. 9-6

In Fig. 9-6, tap the waveform, then the pre-defined waveform has been set.

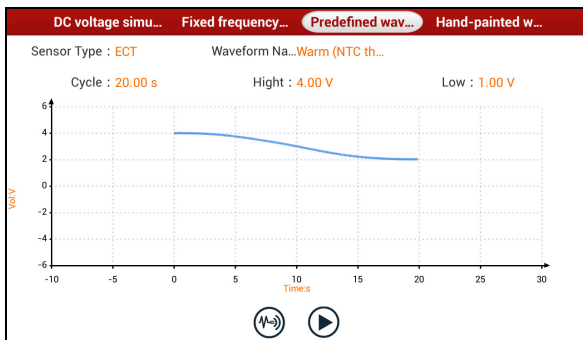



Fig. 9-7

In Fig. 9-7, tap  button to perform simulation test.

4. Hand-painted waveform simulation

This option offers great convenience for users to simulate special waveform or fault wave. Users only draw the shape of waveform which needs to be simulated in central drawing area, and then configure some parameters on the top, namely high level, low level, and cycle of waveform, then tap , X-431 PAD III will output a waveform as desired.

⚠ Warning: Just draw a complete periodic waveform (when it is output, the system

will regard the waveform in the drawing area as a periodic one). Users should draw as large as wave in drawing zone so that the system can sample more points to reduce tolerance.

In Fig. 9-2, tap “Hand-painted waveform simulation”, a screen similar to Fig. 9-8 will appear.

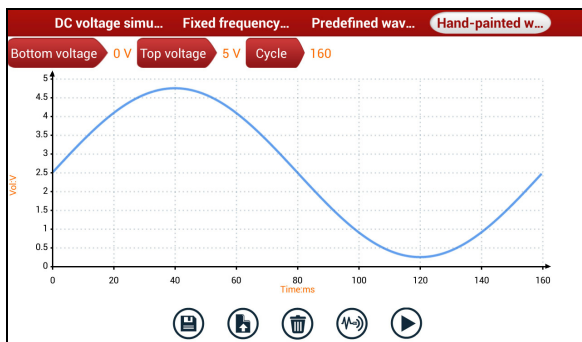

Fig. 9-8

Button descriptions:

[📁]: Save the current waveform.

[🏠]: Loads the previously saved hand-drawn waveform.

[🗑️]: Clear all hand-drawn waveform.

[🔄]: Click to call out the predefined waveform for reference.

[▶️]: Continues the following operation.

9.3.3 Precautions on checking vehicle sensor

- Hold the connector when plugging or unplugging it. Do not pull the cable for unplugging.
- At first check the fuse, fusible line and terminals. Then check others after eliminating these faults.
- When measuring voltage, the ignition switch should be on and the battery voltage should not be less than 11V.
- When measuring voltage, please shake the lead lightly in the vertical and horizontal direction for more precision.
- When checking whether there is open in the line, disconnect the CEU and the relevant sensor at first, then measure the resistance among the ports of sensor in order to determine whether open-circuit / contact fault exists or not.

- When checking if there is a short in the line, please disconnect the CEU and the relevant sensor, then measure the resistance value of the ports between the connected port and the vehicle body. If the resistance value is more than $1M\Omega$, no fault occurs.
- Before disassembling the engine electrical control system cable, cut off the power supply, that is, turn the ignition switch OFF and disconnect the cables on the battery poles.
- Contact the test probe and the two terminals/ the two leads to be measured when measuring the voltage between the two terminals or the two leads.
- Contact the red test probe to the terminal/ the cable to be measured, and the black probe to the ground when measuring voltage of one terminal/ one cable.
- When checking the continuity of the terminals, contacts and leads, the method for measuring their resistances can be used.
- Check the faults in the terminals of the CEU to sensors, relays, etc.
- There are two test probes in the testing wire. The black one is the common signal terminal (signal GND); the red one is the input terminal for voltage, resistance, and frequency test and output terminal for simulation voltage, simulation frequency and oxygen sensor. Please choose the correct probes to match the different terminals.

10 Multimeter (Toolbox)

10.1 Main Menu

Make sure the X-431 PAD III handset and the sensorbox are properly connected (Refer to Chapter 9.3.1 Connections for details), launch X-431 PAD III application, tap “Toolbox” -> “Multimeter” to display the test menu.

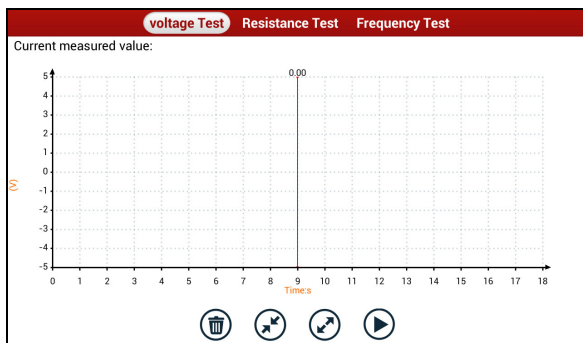

Fig. 10-1

Tap the desired test to perform related test.

The operation method on **Resistance Test** and **Frequency Test** is identical to that of **Voltage Test**. Here take Voltage test as an example for demonstration.

Tap “Voltage Test”, a screen similar to Fig. 10-2 appears:

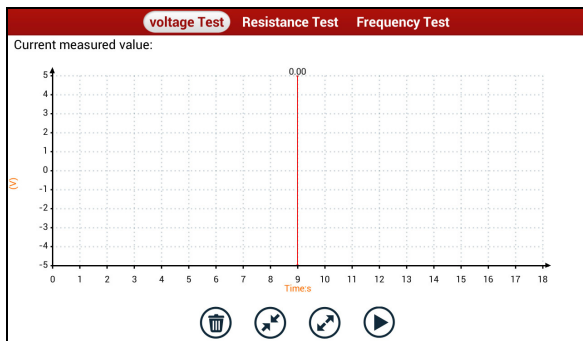





Fig. 10-2

The following operations can be done:

: Erases the currently displayed waveform and display it starting from the left.

: Reduces the range and zoom in the waveform.

: Increase the range and zoom out the waveform.

: Starts or stops the testing process.

10.2 Test Sample

Knock sensor testing

(1) Resistance test for knock sensor

Switch ignition "OFF", unplug the wire connector of knock sensor, test the resistance between the wire terminal and the case of knock sensor with "Resistance test" function, it shall be ∞ (disconnected), and if it is 0Ω (conductive), which means the knock sensor shall be replaced. For the magnetostriction knock sensor, it can also test the resistance by the "Resistance measurement" function; the resistance shall be compliant with the specified value (see specific service manual for the detailed data), otherwise, the knock sensor shall be replaced.

(2) Checking for the output signal of knock sensor

Unplug the wire connector of knock sensor, check voltage between knock sensor connector terminal and ground wire of knock, it should be output pulse voltage; otherwise, the knock sensor shall be replaced.

Coolant temperature sensor testing

(1) Resistance test for coolant temperature sensor

On vehicle testing:

Switch ignition "OFF" and unplug the wire connector of coolant temperature sensor, then use the "Resistance measurement" to test the Resistance between two terminals of sensor. The relationship between the resistance and the temperature is in inversely proportion (negative temperature coefficient), which shall be less than $1k\Omega$ during warming up.

Independent testing:

Unplug the wire connector of coolant temperature sensor, then remove the sensor from the engine; place the sensor into a breaker with water and heat the water, then use the "Resistance measurement" to test the Resistance between two terminals of coolant temperature sensor at different water temperature. Compared the measured value with the standard value, if the Resistance is not

compliant with the standard, then the coolant temperature sensor shall be replaced.

(2) Output signal voltage testing for coolant temperature sensor

After installing the coolant temperature sensor, plug the wire connector of sensor, and then switch ignition ON, test the output signal voltage between the two terminals of wire connector. The tested voltage shall be in inverse proportional with the coolant temperature. When the harness of coolant temperature sensor is disconnected, the voltage shall be about 5V if the ignition switch is ON.

11 Batterybox (Toolbox)

11.1 Product Summary

X-431 PAD III provides an optional function of automotive battery test, which adopts the latest state-of-the-art conductance testing technology in the world and can test vehicle's battery status. Two testing environments (Inside the Vehicle and Outside the Vehicle) are available and applicable to battery test. In addition to battery test, charging system and actuation system test can be done while Inside the Vehicle is selected.

It supports various battery standards and specifications, including CCA, DIN, IEC, EN, JIS, SAE and GB etc. It is specifically designed to help car owner, repair workshop, battery factory use battery test instrument properly and determine whether the battery is normal or not.

Battery test aims to check starting plumbic acid storage batteries for vehicles, ship, boats and aviations, etc. It can test all kinds of batteries complying with CCA, DIN, JIS, EN, GB and SA standards. For detailed test standards, please refer to Table 11-1.

Table 11-1 Test standard

| Standards | Standard (Full name) | Test capacity range |
|-----------|---------------------------------|---------------------|
| CCA | Battery Council International | 100~1700 |
| DIN | Deutsche Industry Normen | 100~1200 |
| JIS | Japanese Industry Standard | 26A17~245H52 |
| EN | Europe Norm | 100~1700 |
| IEC | National Electrical Commission | 100~1200 |
| GB | Chinese National Standard | 100~1200 |
| SAE | Society of Automotive Engineers | 100~1700 |

11.2 Test Environment

11.2.1 Test environment

Inside the vehicle test indicates that the battery connects to loading devices, such as engine, etc. After doing battery test, it can perform charging system and actuation system test, which is proceeded as a whole simultaneously. Charging system and actuation system test is not required but must not be performed before battery test. Because it is difficult for vehicle technicians to judge where is faulty exactly if they have the faintest idea of battery's status itself.

Outside the vehicle test indicates that the battery is disconnected from all loading devices on vehicles. Therefore, only battery test is supported in this condition.

11.2.2 Battery status and description

There are mainly 5 states as follows:

| No. | States | Descriptions |
|-----|-----------------|---|
| 1 | Good battery | Indicates battery is normal. |
| 2 | Replace battery | Indicates that battery is aged or becomes rejected, or battery life cycle approaches to be exhausted. In this case, battery voltage appears to be normal, but battery itself is not well, i.e. battery polarity board has been completely vulcanized or aged. Please replace battery immediately. |
| 3 | Good-recharge | Stands for low battery. The battery is good itself. |
| 4 | Charge-retest | It is better for a few batteries to be fully charged before testing in order to avoid judging in error under special conditions. |
| 5 | Bad cell | Indicates one of the battery cells is bad and cannot work normally, but for which one is bad, it can't be verified. In this case, battery voltage is generally lower than 11V, mainly resulting from internal circuitry damage, such as short circuit, open circuit, dummy weld etc. |

11.3 Batterybox Structure & Accessories

11.3.1 Batterybox structure

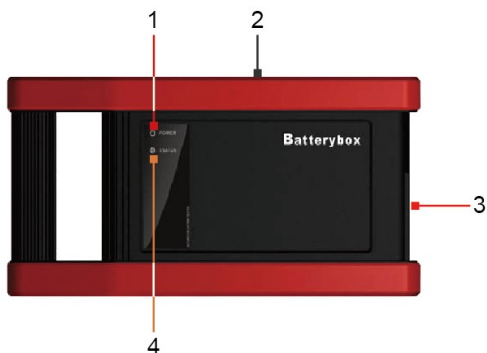

Fig.11-1 Batterybox

Below describes the ports and indicators for the Batterybox.

| No. | Name | Descriptions |
|-----|-------------------|---|
| 1 | Power LED | It keeps solid red after the Scopebox is powered on. |
| 2 | B-shaped USB port | Connect to the diagnostic tool via USB cable so that the signal can be displayed on the tool. |
| 3 | Battery connector | Connect the Kelvin clip to battery for battery test. |
| 4 | Status LED | |

11.3.2 Test accessories



Fig. 11-2 Kelvin clip



Fig. 11-3 A/B cable

11.4. Connections & Operations

11.4.1 Connection

Connect one end of the USB cable to the B-shaped USB port of the Batterybox, and tighten the captive screws, and then connect the other end to the USB port of the diagnostic tool. This connection applies to outside the vehicle test and inside the vehicle.

*Notes:

1. Wait about 10 seconds and begin to communicate since the batterybox needs to initialize after connection is complete, otherwise, communication may fail.
2. Red lamp on the batterybox means it has been successfully powered up; If the green light is always on, it indicates the clip is well connected; while the green light blinks, it indicates that the clip has poor contact. Do not perform any test until the clip and A/B cable are properly connected.

11.4.2 Inside the vehicle test

Battery test and charging system & actuation system test can be done in this mode.

1. Battery test

Enter battery test main menu, and select a desired test environment as shown in Fig. 11-4.

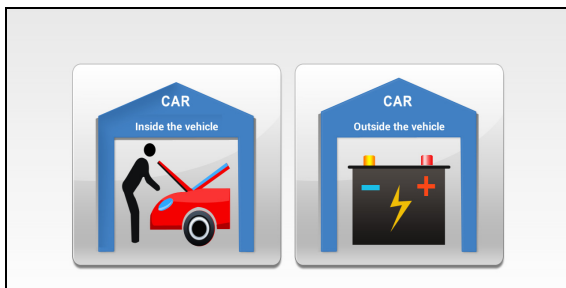



Fig. 11-4

*Note: The sequences of inside the vehicle and outside the vehicle test are almost the same, but under inside the vehicle condition, all loads in vehicles must be powered off for getting an exact test value.

1. Firstly, the system detects whether floating electricity exists or not before testing. If yes, turn on the headlamp to remove it. Otherwise, the system starts test program directly.
2. Tap [Inside the vehicle], the system starts detecting floating electricity automatically. If floating electricity is detected, it will prompt you to turn on the headlamp.
3. Follow the on-screen instructions to turn on headlamp, the system starts removing floating electricity.
4. Once the floating electricity is removed, a prompt message box “The floating electricity has been removed, please turn off the headlamp to continue the testing” will appear on the screen.
5. Follow the on-screen instructions to turn off the headlamp and tap [OK], the system will continue the testing. Tap , it will enter testing standard selection screen.

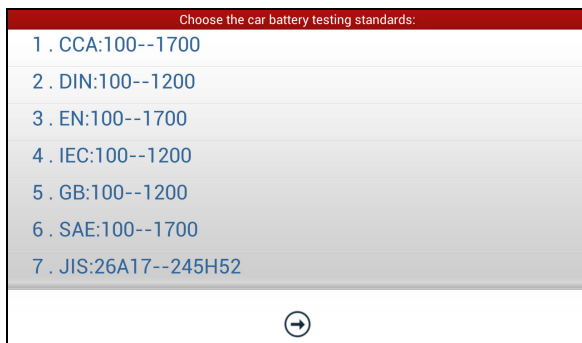



Fig. 11-5

6. Select a testing standard except for JIS and tap , a screen similar to Fig. 11-6 will appear. Users can adjust capacity size by tapping on < or > or by dragging the slider on the bar.

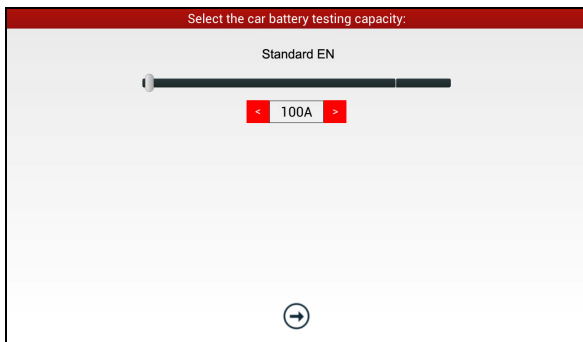



Fig. 11-6

If JIS is selected, tap , the system will enter Select testing capacity screen. Users can select corresponding standard capacity value according to battery model marked on battery.

7. Tap  and the testing result will appear on the screen.

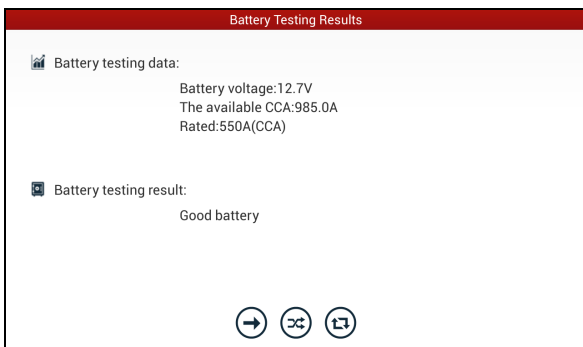





Fig. 11-7

: Tap it to perform the charging system and starting system test.

: Tap to test it again.

: Tap it to reset the test.

2. Charging system and starting system test

While performing this test, the battery's charging voltage value and starting voltage can be obtained in case of engine starting and accelerating. Based on

the data, the system will judge whether battery's charging and actuation status is normal or not.

Tap  in Fig. 11-7, a dialog box will pop up as Fig. 11-8.

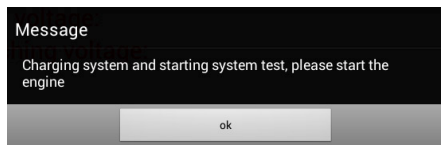

Fig. 11-8

After detecting engine starting, follow the instructions on the screen to increase the speed.

The system begins to receive test data information after acceleration was detected, as shown in Fig. 11-9.

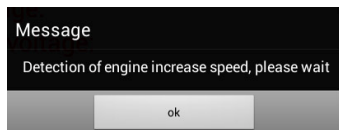

Fig. 11-9

Tap [OK], test data will be shown on the screen.

*Note: It is unnecessary to perform charging system and start system test after finishing battery test, but battery test must be done before undergoing charging system and starting system test.

11.4.3 Outside the vehicle test

It only applies to battery test and detecting floating electricity will be ignored while performing battery test.

On Fig. 11-4, tap [Outside the vehicle] to select battery test standard.

The following operation steps are identical to Steps 6~7 in Chapter 11.4.2 Battery test. Please refer to it for details.

11.5 Precautions On Battery Test

For the purpose of getting accurate test results, unless otherwise special required, all loads need to be power off such as headlamp, engine etc. before testing battery.

The operating time required for charging system and actuation system test varies from person to person. If the engine does not start or accelerate within 30 seconds, the system will prompt you "receiving timeout" and return to the initial status.

Whether Engine is off or not has no influence on charging and actuation test result after increased speed is detected, but other loads need to be powered off.

The accuracy of battery voltage, charging voltage, start voltage is 0.01V in test results; CCA (Cold Cranking Amps) precision is 5CCA.

Generally, charging voltage value is greater than starting voltage.

Charging voltage range is as follows: 13.8--14.5V for domestic vehicle; 13.3--15.5V for imported vehicles. The voltage varies with different car models, so you have to judge based on related vehicle models. In general, the DC voltage is stable, but it also varies with different revolution speed.

Starting voltage range: The value higher than 9.6V is regular, otherwise it is too low. Due to different situations, whether the starting voltage is higher or not does not mean the vehicles or batteries are faulty. For detailed faults, other special equipments are needed. To validate the accuracy of the value, the best method is to collect the signals of starting and charging voltage and observe it on an oscilloscope.

Generally, the voltage is lower than 11V for the bad cell battery, but it is possible that the battery is completely exhausted or has a serious low capacity. In this case, just recharge your battery. Bad cell always happens when the loads on a stopping vehicle are turned on for a long time.

Please note that it is normal for quick detecting of "Increase speed" because it follows the theory of detecting "Increase speed": If the detected voltage is higher than the previous battery test voltage, the system will prompt you a message of "Engine has been speeded"

It has no influence on test result in the event that engine's output voltage or engine revolution is not very stable. No matter whether the vehicle is accelerated or not, the output voltage only differs within 0.2V.

While doing inside the vehicle test, Kelvin clip is always found to be in poor contact. To remain it in good contact, please shake it several times before testing. Take down the battery connector, and test it again, the value probably varies. The deviation may arise from battery connector.

Pay more attention to connect the clip. The battery poles connect with conductor, which makes the clip has a poor connection when testing battery. A tolerance of dozens of CCA occurs if the clip is out of position, or oil, dust attaches on the

pole. The gear and main body of clip should be fully matched with battery poles.

*Notes:

1. Battery poles inside the vehicle are enveloped by connectors, which may produce some errors for test results. The tolerance results from the resistance of connectors. The greater the resistance value is, the greater the tolerance becomes. But generally, the tolerance does not affect the test conclusion.
2. Testing the battery separately generates an exact test result. The battery box is a very useful auxiliary tool for quick test. If any problems were found, test it separately for getting an exact test result.

12 Oscilloscope (Toolbox)

12.1 Introduction

The Scopebox is an optional add-on module of X-431 PAD III, including automotive oscilloscope and automotive ignition waveform.

Automotive oscilloscope can make the auto repair technician quickly judge the faults on automotive electronic equipment and wiring, and the oscilloscope sweep speed is far greater than the signal frequency of such vehicles, usually 5-10 times of the measured signal. The automotive oscilloscope not only can quickly acquire the circuit signal, but also can slowly display the waveform to observe and analyze. It can also record and store the tested signal waveform which can be recalled to observe for the fast signal, having great convenience to failure analysis. Either high-speed signal (e.g.: Injection nozzle, intermittent fault signal) or the slow-speed signal (e.g. the throttle position change and the oxygen sensor signal) can be observed through automotive oscilloscope in an appropriate waveform.

The electronic signal can be compared and judged via measuring five parameters indexes. The five parameters are the amplitude (the maximum voltage of signal), the frequency (the cycle time of signal), the shape (the appearance of signal), the pulse width (the duty cycle or the time range of signal), and the array (the repetition characteristic of signal), which can be tested, displayed, saved by the automotive oscilloscope. Via the waveform analysis can further detect the circuit fault on sensors, actuators, circuits, and electronic control units, etc.

12.2 Structure & Accessories

12.2.1 Scopebox structure

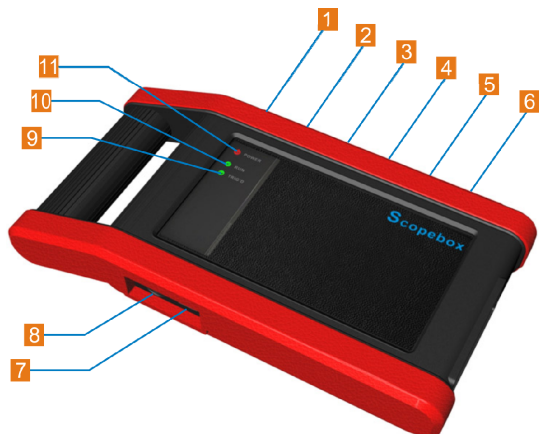

Fig 12-1 Scopebox Structure Diagram

Table 12-1 shows the ports and indicators for the Scopebox.



| No. | Name | Description |
|-----|------------------------|---|
| 1 | Fixed signal generator | Generate a square signal with fixed 1K frequency. |
| 2 | CH1 | Channel 1 |
| 3 | CH2 | Channel 2 |
| 4 | CH3 | Channel 3 |
| 5 | CH4 | Channel 4 |
| 6 | External trigger | External trigger signal (*It only applies if the Scopebox failed to trigger the signal itself.) |
| 7 | B-shaped USB Port | Connect to the diagnostic tool via USB cable so that the signal can be displayed on the tool. |
| 8 | Power interface | To provide power to it via the power |





| | | |
|----|-------------------------|--|
| | | adaptor or battery clamps cable. |
| 9 | Communication indicator | It blinks in process of data communication. |
| 10 | Running indicator | It remains steady green after the Scopebox is running. |
| 11 | Power indicator | It keeps steady red after the Scopebox is powered on. |

12.2.2 Scopebox accessories



The Scopebox includes the auto test leads, secondary pickup cable for 4-channel oscilloscope, crocodile clips for 4-channel oscilloscope, etc. See the packing list attached to the product for the detailed accessories.

Table 12-2 Accessory checklist

| No. | Name | Picture |
|-----|-----------------------|---|
| 1 | BNC to 4mm Test Leads |  <p>Test lead of a male BNC connector to (2) 4mm connectors. It is a kind of special line for assisting automobile Scopebox to test various types of signals. 4mm connectors are coded in two colors: black (earth wire) and red (positive pole which should be connected with the 6-way Breakout Leads). Moreover, it can also work with the 20:1 Attenuator.</p> |
| 2 | 6-way Breakout Leads |  <p>Each lead has 6 blades wired to 6 sockets, allowing you to insert it between a plug and socket pair, other ends are 6 (4 mm) sockets which can be</p> |

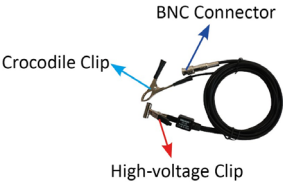
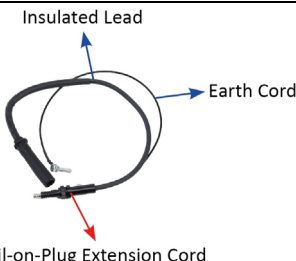
| | | |
|---|----------------------|---|
| | | <p>connected to the BNC to 4mm Test Lead.</p> <p>With these 6-way leads, you will be able to test most of the sensors and actuators on all makes and models of vehicle, including MAP, temperature, throttle position and airflow sensors, fuel pumps, primary ignition circuits and fuel injectors.</p> |
| 3 | USB cable |  <p>Connects the Scopebox and diagnostic tool so that the sampled signal can be displayed on the diagnostic tool.</p> |
| 4 | Power adaptor |  <p>To supply power to the Scopebox through connection to AC outlet.</p> |
| 5 | Battery clamps cable |  <p>To supply power to the Scopebox through connection to vehicle's battery.</p> |
| 6 | 20:1 Attenuator |  <p>It allows the Scopebox to measure fuel injector and primary ignition waveforms.</p> <p>*Note: Please note this attenuator should be not used for any high voltage measurements other than fuel injectors and primary ignition.</p> |

| | | |
|---|-----------------------------------|---|
| 7 | Secondary ignition pick-up |  <p>This ignition pick-up is applied in the following situations: Secondary-distributor ignition analysis, Secondary-simultaneous ignition analysis and Secondary-direct ignition analysis.</p> <p>It has three ends: BNC connector (for connecting to CH1/CH2/CH3/CH4), crocodile clip (for Grounding) and high-voltage clip (for connecting high-voltage line), near which has an attenuator equipped for high-pressure attenuation to prevent the Scopebox from being impacted.</p> <p>*Notes:</p> <ol style="list-style-type: none"> 1). The high voltage clip should be clamped on the insulated lead (COP Extension Cord, see Item 8) instead of on the spark plug to prevent breakdown and electric shock. 2). Please try to keep an instance of 2 inch from other high-voltage line to avoid the interference. |
| 8 | COP (Coil-on-Plug) Extension Cord |  <p>Coil-on-Plug extension cord (including earth cord) allows you to take accurate secondary ignition measurements on secondary-direct (Coil-on-Plug)</p> |

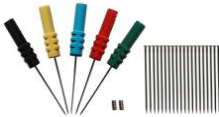
| | | |
|----|-----------------------|--|
| | | ignition systems. It can be applied in the condition that there are no, or limited access to any spark plug leads. |
| 9 | Multimeter probes |  |
| 10 | Crocodile clips |  Designed to connect the bare terminals or leads. |
| 11 | Back Probe Pins Suite |  They are mainly used for piercing the insulation of wires to allow for automotive electrical measurements without causing damage to the wires. Additionally they can be used as pin-tip probes while working with small circuit boards. |

12.3 Connection & Initial Use

12.3.1 Probe Compensation

Perform this function to match the characteristics of the probe (optional) and the channel input. The probe that has not been compensated may cause measurement tolerance or error.

1. Set the switch to "X10" (the default is X1) on the probe and connect it to the any Channel of the Scopebox.
2. Follow Steps 1-2 in Item 2 "Connection" mentioned below to connect the Scopebox and diagnostic tool. Launch the App and open "Scope" to run it.
3. From the "Vertical Setting" menu, select the corresponding channel and set the Probe attenuation to 1:10.
4. Attach the probe tip to the Probe Compensator and the ground nip of the

reference lead to the ground connector. When using the probe hook-tip, insert the tip onto the probe compensator firmly to ensure a proper connection.

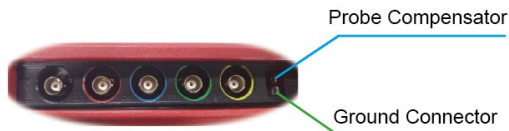

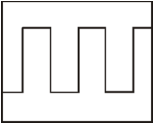
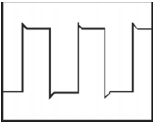
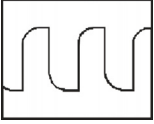

Fig 12-2

- Tap the  button located on the bottom of the screen, a square wave (approximately 1kHzm 2V peak-to-peak) will be displayed within several seconds.

*Note: The above steps also can be applied to check whether the signal input/output of other Channels are normal or not.

Check the shape of the displayed waveform to determine whether the probe is correctly compensated.

| | | |
|-----------------------|---|--|
| Correctly Compensated |  | |
| Over Compensated |  | *Note: If necessary, use a non-metallic tool to adjust the trimmer capacitor of the probe for the fattest square wave being displayed on the Scopebox. |
| Under Compensated |  | |

*Warning: To avoid electric shock while using the probe, make sure the insulated cable is perfect, and do not touch the metallic portions of the probe head while it is connected with a high-voltage source.

12.3.2 Connection

For different applications, the connection methods may vary.

1. Power the Scopebox on: Power is provided to the Scopebox in either of the following ways:

- **Power adaptor:** Insert one end of the power adaptor into the Power interface of the Scopebox, and the other end to the AC outlet.
- **Battery clamps cable:** Plug one end of the power adaptor into the Power interface of the Scopebox, and then clamp the other two terminals to the vehicle's battery (Red to +, and Black to -) respectively.

2. Connect the B-shaped terminal of the USB cable to the Scopebox USB port, and the other end to the USB port of the diagnostic tool.

A. While testing sensors or actuators,

3. Connect the BNC connector of the BNC to 4mm test lead to the CH1/CH2/CH3/CH4, and plug the black (GND) and red (SIGNAL) 4mm connectors into the Black (GND) and other color (SIGNAL) banana sockets of the 6-way breakout leads respectively.

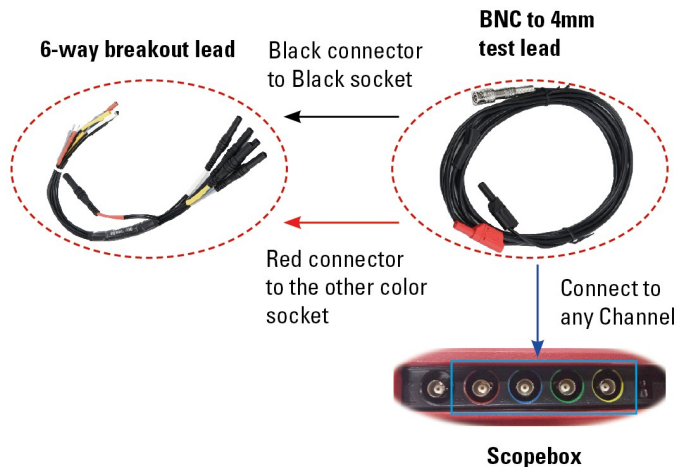

Fig. 12-3

4. Connect the black terminal and signal wire (its other end connected to the red 4mm connector) of the 6-way breakout lead to the GND and signal terminal of

the vehicle sensor.

B. While testing Secondary-distributor ignition analysis/Secondary-simultaneous ignition analysis.

3. Connect the BNC connector of the secondary ignition pick-up to any channel of the Scopebox, and clamp the crocodile clips and high-voltage clips onto the vehicle ground and high-voltage line respectively.

The connection is as follows:

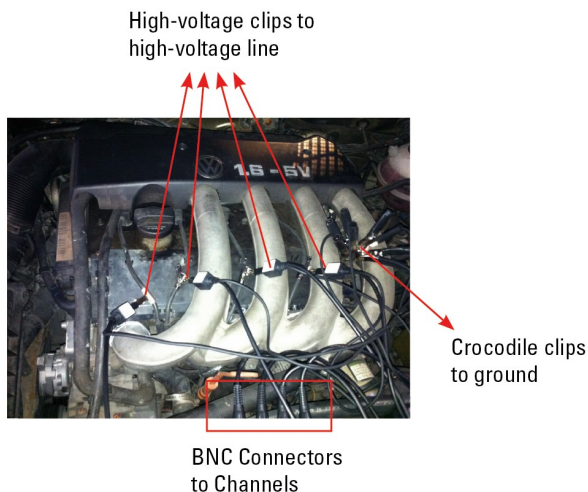

Fig. 12-4

For detailed operations, please refer to Chapter 13.

C. While testing Secondary-direct ignition analysis.

3. *When the high-voltage wire is exposed*, plug the BNC end of secondary ignition pickup into CH1/CH2/CH3/CH4 channel of Scopebox, then connect the high-voltage clip to high-voltage line, and crocodile clips to ground.
4. *If no high-voltage wire is exposed*, dismantle ignition coil of tested cylinder. Connect one end of the COP extension cord to the ignition coil which should be grounded via COP earth cord, and insert the other end into the cylinder to joint with spark plug. Then plug the BNC end of secondary ignition pickup into CH1/CH2/CH3/CH4 channel of Scopebox, and then connect the high-voltage

clip to high-voltage line, and crocodile clips to ground.

The connection is as follows:

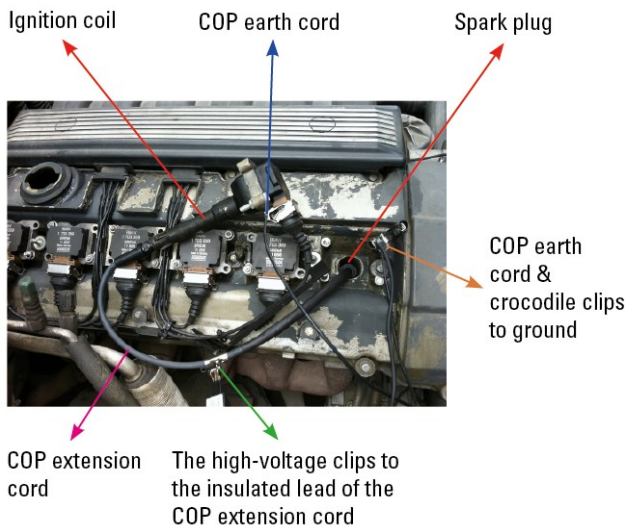

Fig. 12-5

For detailed operations, please refer to Chapter 13.

12.3.3 Initial interface introduction

Fig. 12-6 displays the initial interface of the Scopebox.

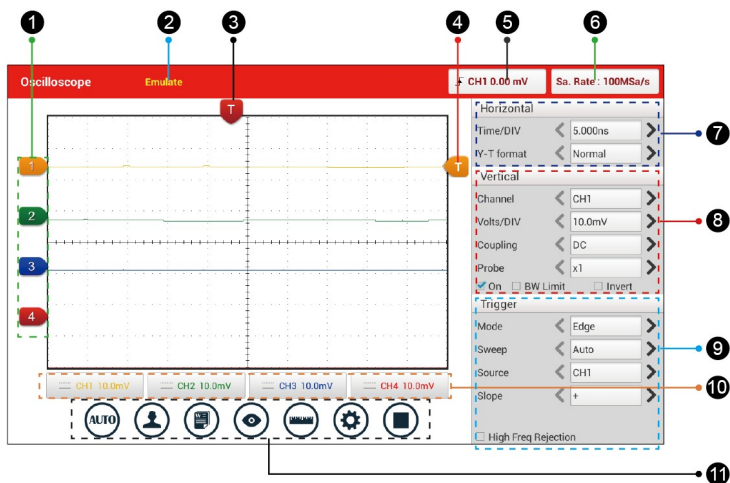









Fig. 12-6

| No. | Descriptions |
|-----|--|
| 1 | Displays the CH1/CH2/CH3/CH4 information: Readouts show the coupling and vertical scale factors of the channels. A "B" icon indicates that the channel is bandwidth limited. |
| 2 | Working mode |
| 3 | Horizontal trigger position marker |
| 4 | Edge trigger level marker |
| 5 | Displays the trigger information, including the edge trigger slope, source and level. |
| 6 | Sample rate |
| 7 | Horizontal Settings Panel: Controls the time base. |

| | |
|----|--|
| 8 | Vertical Settings Panel: Controls the amplitude of the displayed signal. User can change the volt/div, coupling and probe attenuation of the CH1/CH2/CH3/CH4. |
| 9 | Trigger Settings Panel: Controls the start event of the sweep. |
| 10 | Channel Selection Button |
| 11 | <p>Function Menu</p> <ul style="list-style-type: none">  [Auto]: It indicates auto trigger setting.  [Ref]: There are expert reference and base reference available. Expert reference enables you to recall your customized expert database, whereas base reference provides automatic pre-setting function of specialized sensors.  [File]: Provides save snapshot, snapshot manager, waveform record and waveform replay.  [View]: Calibration and display settings are available.  [Measure]: Includes signal source measurement, horizontal measurement, vertical measurement and clear measurement.  [Settings]: Shows/hides the parameter settings area including horizontal settings, vertical settings and trigger settings.  [Start/Stop]: Starts/stops collecting waveforms. |

12.4 Operations

12.4.1 Channel selection and attributes setting

<1> Channel selection

There are two ways available for channel selection:

- A. Select from the channel tab shown at the bottom of the waveform display area
- B. Select from Vertical settings

*Note: For better comparison and identification, each channel and waveform are marked in different colors.

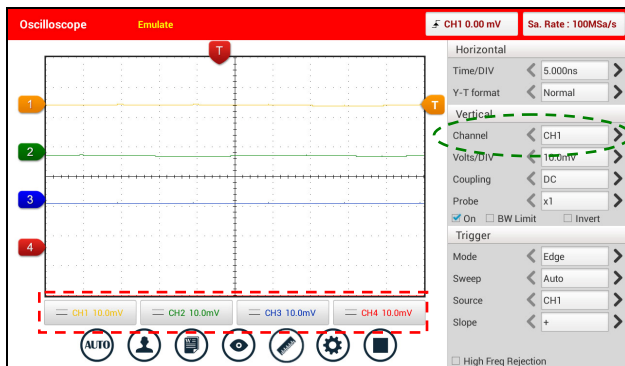

Fig. 12-7

<2> Channel attributes & trigger setting

Channel attributes can be set via horizontal settings and vertical settings.

Horizontal Settings

User can make some settings directly by tapping < or > next to options.

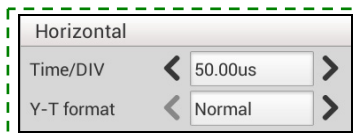

Fig. 12-8

Options descriptions:

| Menu | Comments/Settings |
|------------|---|
| Time/DIV | Horizontal scale. If the waveform acquisition is stopped (using the button), the Time/DIV selector expands or compresses the waveform. |
| Y-T format | The conventional oscilloscope display format. It shows the voltage of a waveform record (on the vertical axis) as it varies over time (on the horizontal axis). |

Vertical Settings

The trigger determines when the Scopebox starts to acquire data and display a

waveform. When a trigger is set up properly, it can convert unstable displays or blank screens into meaningful waveforms.

When the Scopebox starts to acquire a waveform, it collects enough data so that it can draw the waveform to the left of the trigger point. The Scopebox continues to acquire data while waiting for the trigger condition to occur. After it detects a trigger, the Scopebox continues to acquire enough data so that it can draw the waveform to the right of the trigger point.

User can make some settings directly by tapping < or > next to options.

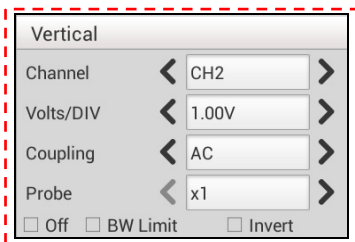

Fig. 12-9

Options descriptions:

| Menu | Comments/Settings |
|-----------|--|
| Channel | To select the channel source. |
| Volts/DIV | It is defined as "Volts/Division" and mainly used to change the resolution. |
| Coupling | Trigger coupling determines what part of the signal passes to the trigger circuit. AC, DC and Ground are included: <u>AC</u> : Blocks the DC component of the input signal. <u>DC</u> : Passes both AC and DC components of the input signal. <u>Ground</u> : Disconnects the input signal. |
| Probe | When using a probe, the Scopebox allows you to select the attenuation factor for the probe. The attenuation factor changes the vertical scaling of the Scopebox so that the measurement results reflect the actual voltage levels at the probe tip. |

| | |
|----------|--|
| BW Limit | <u>ON</u> : Limits the channel bandwidth to 20MHz to reduce display noise. <u>OFF</u> : Get full bandwidth. |
| Invert | <u>ON</u> : Turn on the invert function. <u>OFF</u> : Restore to the original display of the waveform. |

Trigger setting

Trigger indicates that when certain waveform meets the conditions that are predefined according to the requirements, the Scopebox acquires the waveform and its adjacent section, and then presents it on the screen.

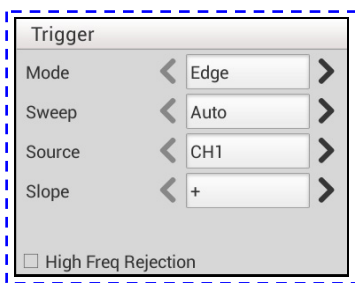

Fig. 12-10

1) If **Edge** trigger is selected (An edge trigger determines whether the Scopebox finds the trigger point on the rising or the falling edge of a signal.):

| Menu | Comments/Settings |
|-------|--|
| Sweep | <p>The sweep mode determines how the Scopebox behaves in the absence of a trigger event. The Scopebox provides three trigger modes: Auto, Normal, and Single.</p> <p><u>Auto</u>: It allows the Scopebox to acquire waveforms even when it does not detect a trigger condition. If no trigger condition occurs while the Scopebox is waiting for a specific period, it will force itself to trigger.</p> <p>When forcing invalid triggers, the Scopebox can not synchronize the waveform, and then waveform seems to roll across the display. If valid triggers occur, the display becomes stable on the screen.</p> |

| | |
|---------------------|---|
| | <p><u>Normal</u>: This mode allows the Scopebox to acquire a waveform only when it is triggered. If no trigger occurs, the Scopebox keeps waiting, and the previous waveform, if any, will remain on the display.</p> <p><u>Single</u>: In this mode, it only acquires the waveform that generates for the first time the trigger conditions are met, and then stops after finishing capture.</p> |
| Source | Select which channel as trigger signal. |
| Slope | + : Trigger on rising edge - : Trigger on falling edge |
| High Freq Rejection | Reject high frequency signals when selected. |

2) If **Pulse Width** trigger is selected (Pulse trigger occurs according to the width of pulse. The abnormal signals can be detected through setting up the pulse width condition):

| Menu | Comments/Settings |
|-------|--|
| Sweep | <p>The sweep mode determines how the Scopebox behaves in the absence of a trigger event. The Scopebox provides three trigger modes: Auto, Normal, and Single.</p> <p><u>Auto</u>: It allows the Scopebox to acquire waveforms even when it does not detect a trigger condition. If no trigger condition occurs while the Scopebox is waiting for a specific period, it will force itself to trigger.</p> <p>When forcing invalid triggers, the Scopebox can not synchronize the waveform, and then waveform seems to roll across the display. If valid triggers occur, the display becomes stable on the screen.</p> <p><u>Normal</u>: This mode allows the Scopebox to acquire a waveform only when it is triggered. If no trigger occurs, the Scopebox keeps waiting, and the previous waveform, if any, will remain on the display.</p> <p><u>Single</u>: In this mode, it only acquires the waveform that generates for the first time the trigger conditions are met, and then stops after finishing capture.</p> |

| | |
|---------------------|--|
| Source | Select which channel as trigger signal. |
| Condition | To select pulse condition. |
| Pulse Width | Set required pulse width. |
| High Freq Rejection | Reject high frequency signals when selected. |

12.4.2 Auto

The Scopebox has an Auto feature that sets up the Scopebox automatically to display the input signal in a best fit.

Tap , the Scopebox may change the current settings to display the signal. It automatically adjusts the vertical and horizontal scaling, as well as the trigger coupling, position, slope, level and mode settings.

12.4.3 View Settings

<1> Calibration

This option adjusts the Scopebox's internal circuitry to get the best accuracy. Use this function to calibrate the Scopebox's vertical and horizontal systems.

Tap  and then tap [Calibration], a dialog box similar to Fig. 12-11 will appear.

Calibration

| | | |
|-------------------------------------|-----|--|
| <input checked="" type="checkbox"/> | CH1 | |
| <input checked="" type="checkbox"/> | CH2 | |
| <input checked="" type="checkbox"/> | CH3 | |
| <input checked="" type="checkbox"/> | CH4 | |

Start

Stop

Exit

During the process of calibration, it is strongly recommended that you should not connect any signal to the CH1/CH2/CH3/CH4 channel. It takes about 2 minutes for each channel, please wait a while!

Fig. 12-11

Check the box before the channel to select it. To deselect it, just uncheck it. After choosing the desired channel(s), tap [Start] to start calibration and [Start] button

will be temporarily invalid during calibrating. Tap [Stop] to stop calibrating. Once it becomes active, it indicates calibration has completed.

*Note: In process of calibration, make sure CH1/CH2/CH3/CH4 has no signal input. Moreover, calibration may take several minutes and please be patient to wait.

<2> REF settings

Reference waveforms are saved waveforms to be selected for display. The reference function will be available after saving the selected waveform to non-volatile memory.

Tap  and then [REF] to enter the REF setting screen.



Fig. 12-12

Tap < or > to select the desired reference value for time/DIV and volts/DIV. To show or hide the REF, just check/uncheck the box before On/Off.

<3> Display settings

Tap  and then [Display settings] to enter the setting screen.

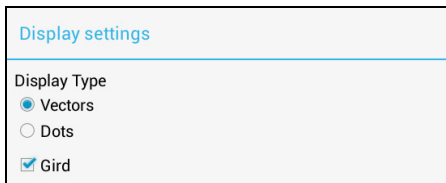

Fig. 12-13

Select "Vectors" or "Dots" to display waveforms as vectors or dots. Check / uncheck the box before Grid to turn on/off grid display.

12.4.4 Measure

<1> Channel source

Tap  and then [Source], a screen similar to Fig. 12-14 will appear.

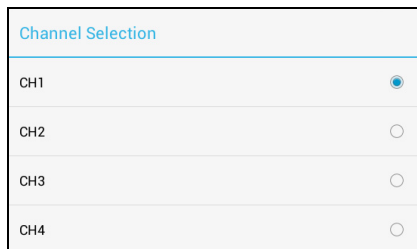



Fig. 12-14

<2> Horizontal / Vertical measure

Horizontal Measure / Vertical Measure are used to measure voltage parameter and time parameter respectively. Drag A line upwards or downwards to control voltage. Move A line left or right to fine-tune timebase. A line is a solid line and B line is a dotted line.

Tap  and then [Horizontal Measure], a screen similar to Fig. 12-15 will appear.

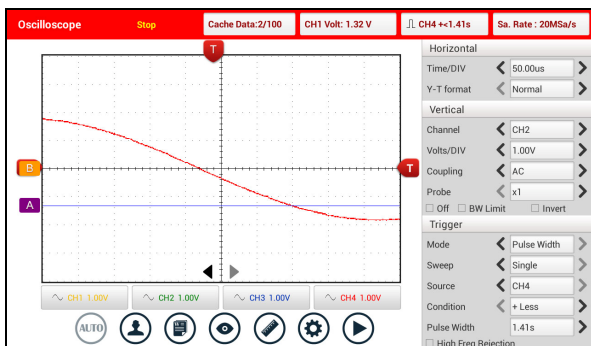



Fig. 12-15

*Note: If no desired channel is selected, the system will take the current source as the default channel.

<3> Clear measure

Tap  and then [Clear Measure], the system will clear the measurement result on screen.

12.4.5 File management

<1> Save snapshot

While viewing sampling data, tap  and then [Save Snapshot] to store the current screen.

<2> Snapshot manager

While viewing sampling data, tap  and then [Snapshot Manager] to enter. View, delete and edit operations are supported.

<3> Record waveform

This function is used to record input waveforms that are acquired by the Scopebox at a specific period, and save it as waveform file which can be recalled in future.

It can be performed only when the Scopebox is collecting data in Normal mode.

Tap , then select [Record] from the pop-up menu to start recording.

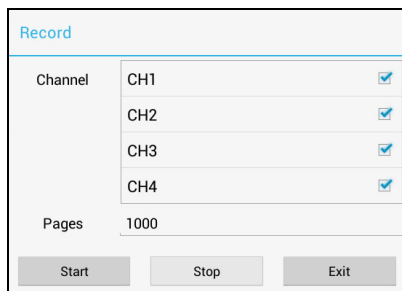

Fig. 12-16

Tap [Start] to start recording with a minimum record length of 10 frames, and [Stop] to stop recording. While recording, the recorded pages will be shown on the screen.

<4> Load waveform for playback

The Import function enables you to import the stored waveform file for playback and review. During replaying, the Scopebox stops collecting data automatically.

Tap , then select [Waveform replay] from the pop-up menu to enter:



Fig. 12-17

Select the file first, and then tap  to open the waveform file. Tap  to starting the playback and tap  to stop it.

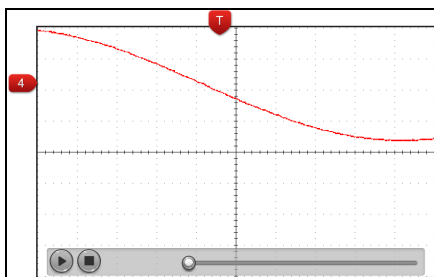





Fig. 12-18

To delete the waveform file, tap . Tap  to return to the previous screen.

12.4.6 Expert reference

<1> Expert Reference

By default, it appears blank. As a matter of fact, Expert reference database is generated by doing the following:

1. Open and edit a snapshot;
2. Select "Joint the expert database" (refer to the following illustration), and then tap  to save the waveform being displayed on the screen as REF.

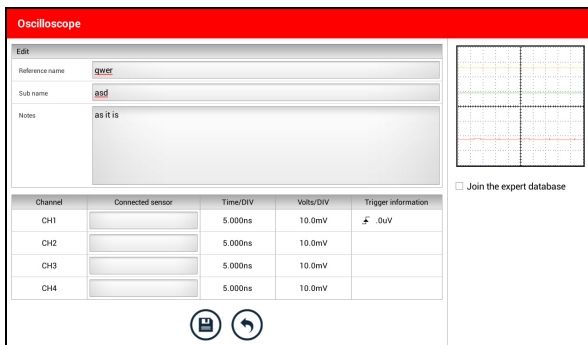





Fig. 12-19

Tap  and then [Expert Reference] to enter, the following operation can be done:

: To load and recall the selected file.

: To delete the selected file.

: To edit the selected file.

<2> Base Reference

Preset waveforms of some sensors are available for your reference.

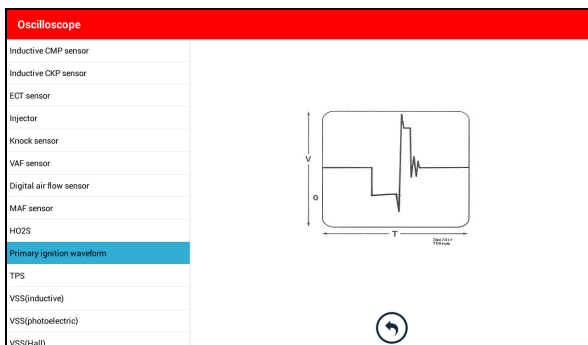

Fig. 12-20

13 Automotive Ignition waveform (Toolbox)

The ignition system is the system which has greatest impact on the performances of gasoline engine, as the statistical data shows that nearly half of the failures are caused by poor work of electrical system. And the performance tests of engine often start from the ignition system. Nowadays ignition system includes distributor and distributorless. Distributorless includes independent ignition and simultaneous ignition.

1. Distributor ignition system i.e. contact breaker with contact-controlled ignition system (commonly known as the platinum) and contact breaker with noncontact-controlled ignition system combined with magnet, hall components or infrared.
2. Independent ignition system: crankshaft sensor send out the ignition timing signal and cylinder identification signal so that the ignition system can send out ignition signal to specified cylinder in specified time, each cylinder has its independent ignition coil.
3. Simultaneous ignition system: two cylinders share one ignition coil, when two cylinder pistons reach top dead center at the same time (one is compression, another is the exhaust), two spark plugs will be ignited at the same time, at this time, the ignition for the former cylinder is in high-pressure low temperature gas mixture, the ignition is valid, while for the latter one is in low-pressure high temperature exhaust gas, the ignition is invalid.

X-431 PAD III can test and analyze the secondary signal for various engine ignition systems.

13.1 Secondary-distributor ignition analysis

The following connection should be made before performing it:

1. Power the Scopebox on: Power is provided to the Scopebox in either of the following ways:
 - **Power adaptor**: Insert one end of the power adaptor into the Power interface of the Scopebox, and the other end to the AC outlet.
 - **Battery clamps cable**: Plug one end of the power adaptor into the Power interface of the Scopebox, and then clamp the other two terminals to the vehicle's battery (Red to +, and Black to -) respectively.

2. Connect the B-shaped terminal of the USB cable to the Scopebox USB port, and the other end to the USB port of the diagnostic tool.
3. Plug the BNC end of secondary ignition pickup into CH1/CH2/CH3/CH4 channel of the Scopebox, and connect the high-voltage clip to high-voltage line, and crocodile clips to ground.

*Tips: Common ignition sequence (the specific sequence is subject to the actual engine ignition sequence)

Four-stroke in-line four-cylinder: 1-2-4-3, or 1-3-4-2

Four-stroke in-line six-cylinder: 1-5-3-6-2-4, or 1-4-2-6-3-5

Four-stroke in-line eight-cylinder: 1-8-4-3-6-5-7-2

Five-cylinder: 1-2-4-5-3

V 6 engine: generally speaking, based on the person sitting on the driver cab, if the right side cylinder numbers on the right side, from the front to the back are as follows: 1, 3, 5; and the cylinder numbers on the left side, from the front to the back are as follows: 2, 4, 6; then the ignition sequence is: 1 - 4 - 5 - 2 - 3 - 6. If the cylinder numbers on the right side, from the front to the back are as follows: 2, 4, 6; and cylinder numbers on the left side, from the front to the back are as follows: 1, 3, 5; then the ignition sequence is: 1 - 6 - 5 - 4 - 3 - 2.

Figure 13-1 below shows the normal ignition waveform of distributor ignition system, the upper one is the secondary waveform, and the lower one is the primary waveform.

The secondary waveform

A section is contact open period; B section is make contact period, which is the magnetizing field of ignition coil.

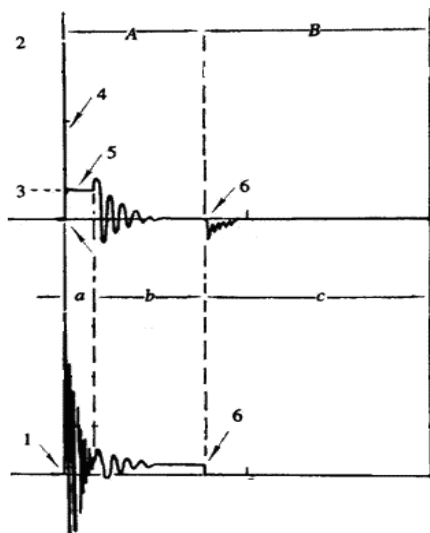

Fig. 13-1

- 1) Contact break point: the primary circuit of ignition coil cut off, the secondary voltage was sensed and increased sharply.
- 2) Ignition voltage: secondary coil voltage overcome the damper of high voltage line, the contact breaker gap and the spark plug gap to release magnetizing energy, 1-2 section is the breakdown voltage
- 3) Spark voltage: For the capacitor discharge voltage
- 4) Ignition voltage pulse: For the charge and discharge sections
- 5) Spark line: The inductance discharge process, i.e. the mutual inductance voltage of ignition coil maintains the conduction of secondary circuit
- 6) Contact point close the current flow into primary coil, the primary coil oscillates due to the mutual inductance.

Primary ignition waveform

Section **a** shows the voltage oscillation on the primary circuit due to the magnetic induction of spark in the duration;

Section **b** shows the damped oscillation generated by remaining magnetic field energy after the spark;

Section **c** shows the make contact magnetizing period of primary coil.

Seen from the waveform, the amplitudes of breaker contact closed angle, break angle and breakdown voltage and spark voltage are very clear, besides, the spark delay period and two oscillations can also be tested. For the ignition system without faults, compared with the whole cycle, the contact closed angle just 45%-50% (four-cylinder), 63%-70% (six-cylinder), or 64%-71% (eight-cylinder); the breakdown voltage is over 15kV; the spark voltage is about 9kV, the spark period is greater than 0.8ms. If these values or waveform are abnormal, it means there is fault or the system needs to be adjusted.

13.2 Secondary-simultaneous ignition analysis

The following connection should be made before performing it:

1. Power the Scopebox on: Power is provided to the Scopebox in either of the following ways:
 - Power adaptor: Insert one end of the power adaptor into the Power interface of the Scopebox, and the other end to the AC outlet.
 - Battery clamps cable: Plug one end of the power adaptor into the Power interface of the Scopebox, and then clamp the other two terminals to the vehicle's battery (Red to +, and Black to -) respectively.
2. Connect the B-shaped terminal of the USB cable to the Scopebox USB port, and the other end to the USB port of the diagnostic tool.
3. Connect the BNC connector of the secondary ignition pick-up to any channel of the Scopebox, and clamp the crocodile clips and high-voltage clips onto the vehicle ground and high-voltage line respectively.

The connection is as follows:

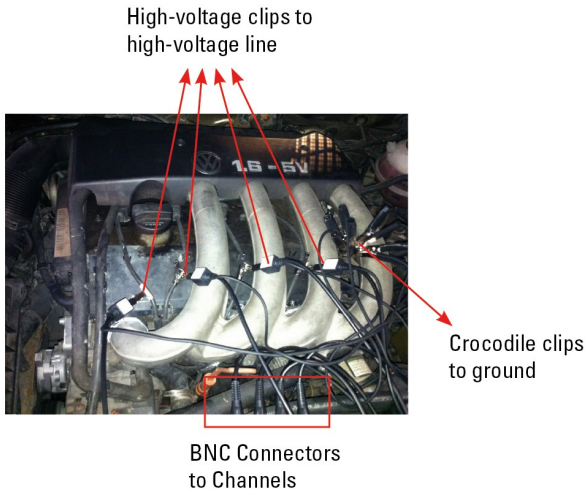

Fig. 13-2

Fig. 13-3 below shows the valid and invalid ignition waveforms. Under the working status of valid ignition, the breakdown voltage and spark voltage are higher because the cylinder is filled with fresh combustible mixture gas, which has a lower ionization level and vice versa.

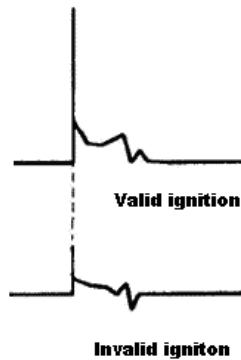

Fig. 13-3

13.3 Secondary-direct ignition analysis

Connection:

1. Power the Scopebox on: Power is provided to the Scopebox in either of the following ways:
 - Power adaptor: Insert one end of the power adaptor into the Power interface of the Scopebox, and the other end to the AC outlet.
 - Battery clamps cable: Plug one end of the power adaptor into the Power interface of the Scopebox, and then clamp the other two terminals to the vehicle's battery (Red to +, and Black to -) respectively.
2. Connect the B-shaped terminal of the USB cable to the Scopebox USB port, and the other end to the USB port of the diagnostic tool.
3. *When the high-voltage wire is exposed*, plug the BNC end of secondary ignition pickup into CH1/CH2/CH3/CH4 channel of Scopebox, then connect the high-voltage clip to high-voltage line, and crocodile clips to ground.
4. *If no high-voltage wire is exposed*, dismantle ignition coil of tested cylinder. Connect one end of the COP extension cord to the ignition coil which should be grounded via COP earth cord, and insert the other end into the cylinder to joint with spark plug. Then plug the BNC end of secondary ignition pickup into CH1/CH2/CH3/CH4 channel of Scopebox, and then connect the high-voltage clip to high-voltage line, and crocodile clips to ground.

The connection is as follows:

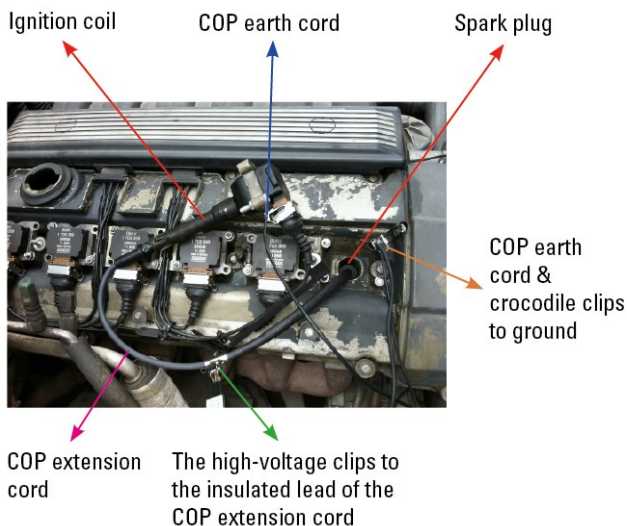

Fig. 13-4

Fig. 13-5 shows the normal secondary (the upper one) and (the lower one) primary ignition waveform of direct ignition system. Because the on/off of primary circuit is not opening/closing of mechanical contact, but the conduction of transistor. The primary voltage has no obvious oscillations within the duration, but the voltage increases during the magnetization process due to current limiting, and this change can cause corresponding fluctuations of secondary voltage line as a result of induction of ignition coil.

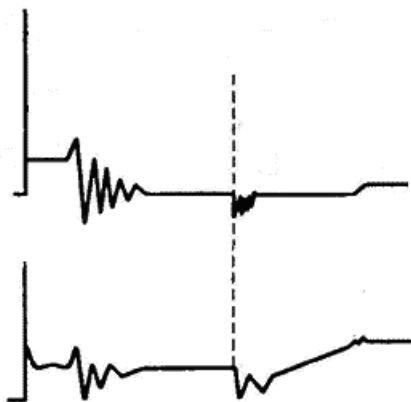

Fig. 13-5

13.4 Waveform analysis mode

The ignition secondary single-cylinder waveform test is mainly used to:

- Analyze the ignition dwell angle of single cylinder.(ignition coil charging time)
- Analyze the capability of ignition coil and secondary high tension circuit (from ignition line to ignition voltage line).
- Find the improper mixture A/F ratio of single cylinder (from combustion line).
- Analyze the capability of capacitance (platinum or ignition system).
- Find the spark plug that causes misfire of the cylinder (from combustion line).

This test can provide very meaningful information about the combustion quality for each cylinder. If necessary, this test can also be performed during driving. Since the secondary ignition waveform is significantly affected by different engines, fuel systems and ignition conditions, it is useful for detecting the faults of engine mechanical parts, fuel system components, and ignition system components. Different parts of the waveform can specify that some components and systems on the specific cylinder have faults. Refer to the instructions for various parts of waveform for the related component working status of specific waveform section.

Test methods and conditions:

Start the engine or drive the vehicle according to the driving performance fault or

poor ignition, etc. Confirm the consistence of judgment standard (the amplitude, frequency, shape and pulse width, etc., for each cylinder), check the fault of the waveform for corresponding components.

Waveform results: observe the ignition coil at the beginning of charging, the relative consistent falling edge represents the dwell angle and ignition timing of each cylinder are precise.

Ignition line:

Observe the height consistence of flashover voltage. Too high flashover voltage (even out of the oscilloscope screen) represents a high resistance existed in the ignition secondary circuit (for example, open circuit, or damaged spark plug or high voltage line, or too large time gap on spark plug), while the too short sparking voltage represents the resistance of ignition secondary circuit is lower than normal value (due to pollutant and broken spark plug or the high voltage line of spark plug has electrical leakage, etc.).

Spark or combustion voltage:

Observe the consistence of spark or combustion voltage, as it represents the consistence of spark plug and the air-fuel ratio of each cylinder. In case that the mixing ratio is too lean, the combustion voltage will be lower than normal value.

Combustion line:

Observe the spark or the combustion line which shall be clean with few clutter, as lots of clutter indicates the cylinder has poor ignition due to ignite too early, damaged nozzle, pollutant spark plug, or other reasons. The duration of combustion line indicates the mixing ratio of the cylinder is abnormal lean or rich. Too long combustion line (usually greater than 2ms) represents the mixing ratio is rich, whereas too short of combustion line (usually less than 0.75ms) represents the mixing ratio is lean.

Ignition coil oscillation:

Observe at least two oscillation waveforms after the combustion line, which will be better if more than three oscillation waveforms, as it represents the ignition coil and capacitor (on Platinum or ignition system) are normal.

Primary voltage analysis

According to the faulty primary voltage waveform collected by the ignition analysis, the related components and mechanical equipment status of ignition system electrical circuit can be analyzed, which provides a reliable basis for the adjustment and maintenance of power circuit to avoid the blind demolition.

The waveform shown on Fig. 13-6, appears a lot of clutter on the contact break point, which is obviously caused by the serious erosion on contact break point. It can be verified via burnishing the contact or changing the circuit breaker.

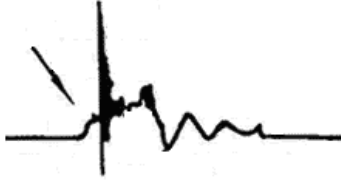

Fig. 13-6

For the primary voltage waveform shown on Fig. 13-7, the damped attenuation cycles obviously reduced on the spark period, the amplitude became lower, which is evidently caused by capacitor leakage.



Fig. 13-7

The waveform on Fig. 13-8 shows the accidental pumping during contact closing period. The irregular beating is caused by insufficient spring force.



Fig. 13-8

The curve on Fig. 13-9 shows the contact angle is too small during the magnetizing period, which is caused by too large contact gap.



Fig. 13-9

A lot of clutter will be displayed on the horizontal section of primary waveform if contact has poor grounding, as shown below figure 13-10.

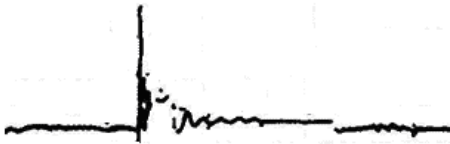

Fig.13-10

Fig. 13-11 shows the fault of low-voltage waveform in electronic ignition system. The voltage does not rise during magnetizing, which indicates that the effect of limitation of the circuit failed and no components on distributorless ignition system can be adjusted. When this waveform is abnormal, you can only replace the ignition coils, igniter, ignition signal generator and cam position sensor, etc., one by one, to find out the faulty component or module.



Fig. 13-11

The secondary waveform is also affected by the spark plug, the combustion process, mixture gas composition, the engine thermal state of the ignition coil, etc., which is more complicated. The following lists a large number of measured secondary faulty waveform for reference. Since various factors lead to the

failures, Fig. 13-12 just shows the major possible factors for the failures.



Secondary circuit resistance is too large



Oil or coke was attached in spark plug



Spark plug gap is too large or mixture gas is too lean



Injector of electronic fuel injection poor work



Spark plug overheated or valve guide leakage



Mixture ratio is too rich or spark plug leak electricity



Mixture ratio is too lean or cylinder pressure is too low



Distributor cover or distributor lead is matched un-tightly



Spark plug was attached carbon or gap is too small

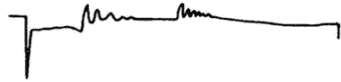

The primary circuit is reverse



Ignition coil or capacitor leak voltage

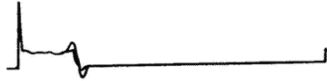

Primary lead of Igniton coil is open



Secondary circuit cut-off intermittently



Secondary coil leakage voltage

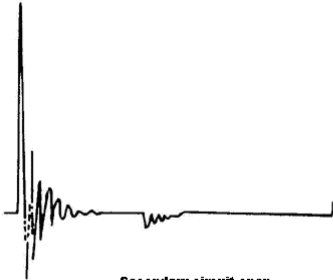

Secondary circuit open

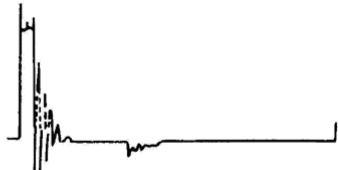

Secondary resistance value is too large

Fig 13-12

14 Personal Center

This function allows users to manage personal information and VCI connector.

14.1 My Report

This option is used to view, delete or share the saved reports.

Tap “**My Report**”, there are total 3 options available.

In case the DTC result is saved on Read Trouble Code page, the files will be listed under **Diagnostic Report** tab.

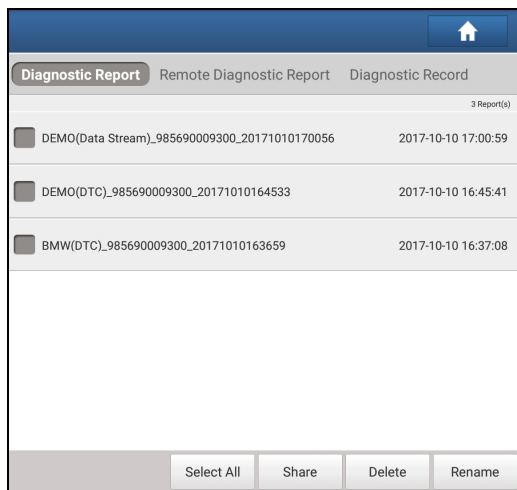

Fig. 14-1

- To select certain report, check the box before the report. To select all reports, tap “Select All”. To deselect all, tap “Unselect”.
- To share the report with others, select the desired one and then tap “Share”.
- Select the desired report and then tap “Delete” to delete it.
- To change the filename of report, tap “Rename”.

If user records the running parameters while reading data stream, it will be saved as .x431 file and appear under **Diagnostic Record** tab.

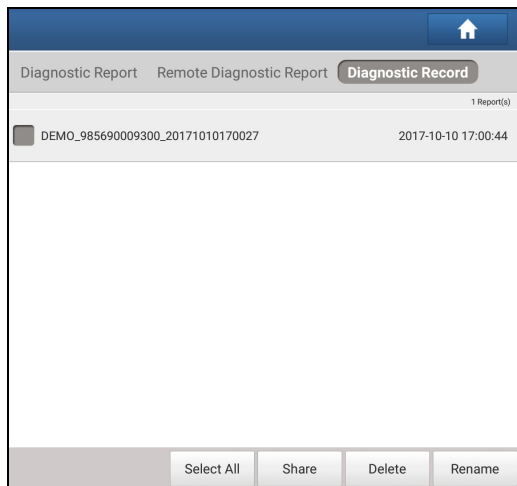

Fig. 14-2

Tap the desired one to enter:

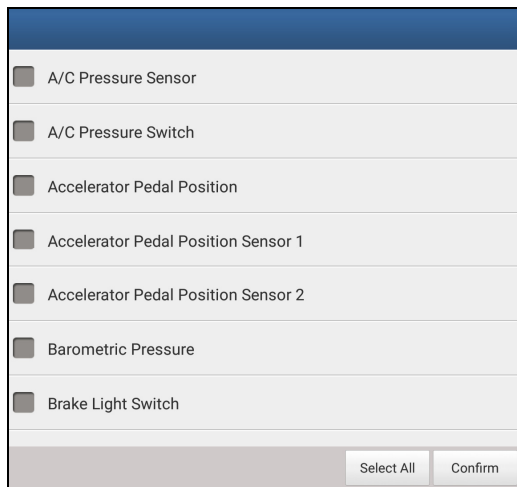







Fig. 14-3

Select the desired data stream items and tap “Confirm” to jump to the playback

page:

| Diagnostic Record | | | |
|-------------------------------------|-----------|------|---|
| Name | Value | Unit | |
| A/C Pressure Sensor | 1828.46 | Kpa |  |
| A/C Pressure Switch | Open (OK) | | |
| Accelerator Pedal Position | 29.82 | % |  |
| Accelerator Pedal Position Sensor 1 | 18.93 | V |  |
| Accelerator Pedal Position Sensor 2 | 18.93 | V |  |
| Barometric Pressure | 77.98 | Kpa |  |

Auto Playback(x1) 0/34

Combine Value

Frame Playback

Fig. 14-4

On-screen Buttons:

 **Graph** – displays the parameters in waveform graphs.

Value – this is the default mode which displays the parameters in texts and shows in list format.

Combine – this option is mostly used in graph merge status for data comparison. In this case, different items are marked in different colors.

Frame Playback – plays back the recorded data stream items frame by frame. Once it is in frame playback mode, this button changes into “Auto Playback”.

Remote Diagnostic Report lists all diagnostic reports generated in process of remote diagnosis.

14.2 VCI

This option allows you to manage all your activated VCI connectors.

If several VCI connectors are activated on this tool, a list of connectors will be displayed on the screen. Once you choose the connector that belongs to other account, you have to log out, and then input the right account to continue.

14.3 VCI Management (For Passenger Vehicle Version)

This option is used for X-431 PAD III to deactivate pairing up with the VCI connector via Bluetooth.

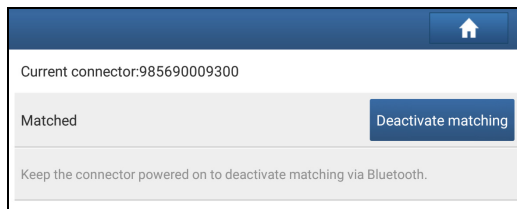

Fig. 14-5

* Note: please be sure to keep the VCI powered on while performing the operation.

14.3 VCI Management (Only for Commercial / Gasoline & Diesel Version)

This option is used to set the communication method between the X-431 PAD III and the VCI module.

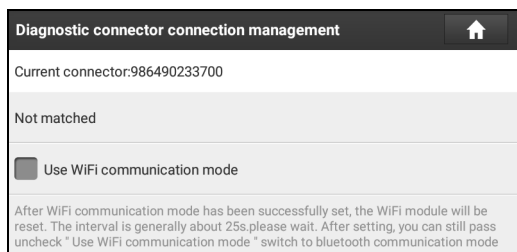
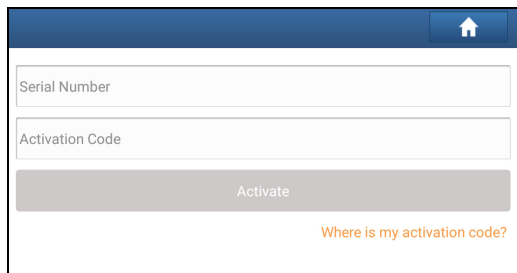

Fig. 14-5

* Note: For detailed operations, please refer to Chapter 4.5.3.

14.4 Activate VCI

This item lets you activate a new VCI device.



The screenshot shows a mobile application interface for activation. At the top right is a home icon. Below it are two text input fields: "Serial Number" and "Activation Code". A large grey button labeled "Activate" is positioned below the input fields. At the bottom right, there is a link in orange text that reads "Where is my activation code?".

Fig. 14-6

Input the Serial Number and Activation Code, and then tap “Activate” to activate it.

For details on how to obtain Activation Code, tap the link below to get help.

14.5 Firmware Fix

Use this item to upgrade and fix diagnostic firmware. During fixing, please do not cut power or switch to other interfaces.

14.6 Profile

Use this item to view and configure personal information.

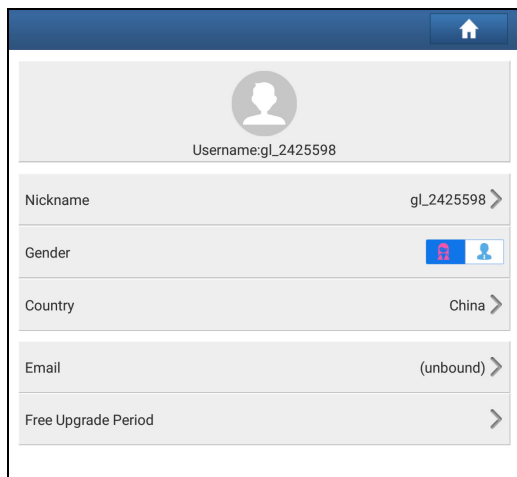

The screenshot shows a mobile application interface for a user profile. At the top right is a home icon. Below it is a profile card with a silhouette icon and the text "Username:gL_2425598". Below the profile card is a list of profile fields, each with a right-pointing chevron:

- Nickname: gL_2425598
- Gender: [Red lock icon] [Blue person icon]
- Country: China
- Email: (unbound)
- Free Upgrade Period: [Chevron]

Fig. 14-7

- Tap the user image to change it.
- Tap > next to “Free Upgrade Period” to check the due date of all diagnostic software.

14.7 Change Password

This item allows you to modify your login password.

14.8 Settings

It enables you to make some application settings and view software version information etc.

14.8.1 Units of Measurement

It is designed to configure the measurement unit. Metric System and English System are available.

14.8.2 Shop Information

This option lets you define your print information. It mainly includes Workshop, Address, Telephone, Fax and License Plate.

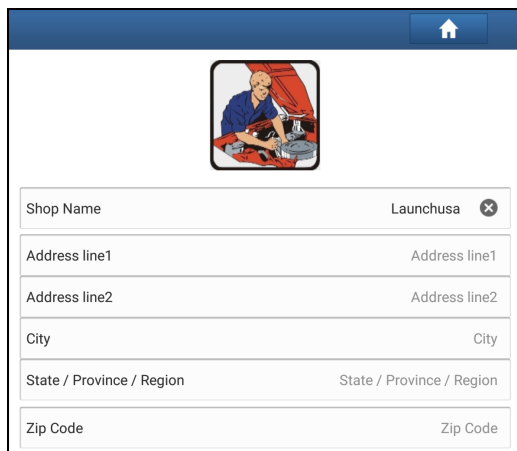

| | | |
|---------------------------|---------------------------|---|
| Shop Name | Launchusa | ✕ |
| Address line1 | Address line1 | |
| Address line2 | Address line2 | |
| City | City | |
| State / Province / Region | State / Province / Region | |
| Zip Code | Zip Code | |

Fig. 15-2

After inputting, tap “Save”.

Once you saved the print information, it will be entered automatically in the “Add Information” box every time you save the diagnostic report.

14.8.3 Printer Set

This option is designed to establish a wireless connection between X-431 PAD III and the Wi-Fi printer (sold separately) while performing printing operations.

Follow the steps below to connect the printer.

1. Tap “Printer Set”.

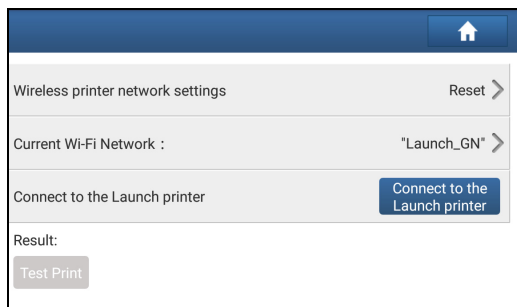

Fig. 15-2

A. If it is the first time you have operated this printer, please proceed the following:

2. For initial use, you are suggested to reset the printer: Press and hold [MODE] & [FEED] for 8 seconds, the following resetting command will be printed out:

at + default = 1

ok

at + reboot = 1

rebooting...

3. Tap “Reset” to configure Wi-Fi printer.

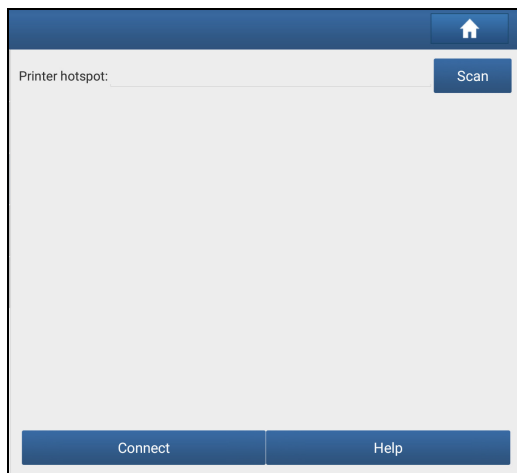

Fig. 15-3

Step 1: Connect the printer:

Tap “Scan” to start scanning and select the desired printer hotspot named with X-431PRINTER-XXXX (XXXX stands for 4 characters), and then tap “Connect” to enter Step 2.

Step 2: Join the Wi-Fi printer into LAN:

Tap “Scan” to select the desired local Wi-Fi network from the list, and type in the security password (If it is an open network, password is not required), and then tap “Confirm”.

4. Once the Wi-Fi network of the printer is connected and the printer is found, tap “Printing test” to test the printing.

Now you can use the Wi-Fi printer to print!

If the printer is not found, please reset the printer to default factory settings (refer to Step 2 for details) and check whether the current device and the printer are on the same LAN.

B. If you have configured the Wi-Fi printer to the LAN:

2. Tap “Connect to Printer”:

- a). If the local network remains as it is, tap “Test Print” directly to test the printing.
- b). If the local network changes, you have to reset the Wi-Fi printer.

14.8.4 About

The software version information and disclaimer are included.

14.8.5 Clear Cache

This item is used to clear the App cache.

Tap “Clear Cache”, a pop-up window will appear on the screen. Tap “OK” to clear cache and the system will restart the App.

14.8.6 Login/Exit from current account

To logout the current user ID, tap “Exit from current account”.

To login the system again, tap “Login”.

15 Other Modules

15.1 Email

The function allows you to send and receive email.

*Note: Before sending or receiving email, you have to set up an email account. In addition, this function required a stable network connection.

1. On the Home screen, tap **Other Modules** -> **Email**.
2. Input the Email address, tap **NEXT**.
3. Choose the desired email account type.
4. Input the password, tap "Next".

*Note: If "Manual setup" is selected, please consult your email service provider for detailed parameter setting.

5. Follow the on-screen instructions to proceed until the system prompts you that the account setup has been finished.

15.2 Browser

15.2.1 Open browser

On the Home screen, tap **Browser** to launch the browser. You can choose the desired homepage or input the website address to browse.

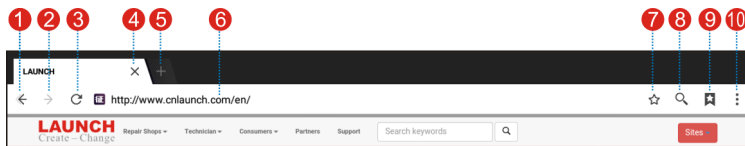

Fig. 15-1

- 1 Return to the previous page.
- 2 Advance to the recently visited page.
- 3 Refresh the current page.
- 4 Close the current page.

| | |
|----|-----------------------------------|
| 5 | Create a new tab. |
| 6 | Input a web address. |
| 7 | Add the current page as bookmark. |
| 8 | Open search bar. |
| 9 | Open bookmark list. |
| 10 | View more options. |

15.2.2 Download files

Files, pictures, and applications can be downloaded from the website in browser. For example:

Tap and hold a picture, then choose “Save image” from pop-up menu to download it.

To download a link, tap and hold it, and then choose “Save link”.

To protect the tablet and personal data, please download applications from trusted sources.

15.3 TeamViewer

TeamViewer is a simple, fast and secure remote control interface, which enables you to receive remote support from technician fellows, colleagues or friends by allowing them to control your tablet on their computer view TeamViewer software.

Computer and mobile devices that run TeamViewer are identified by a globally unique ID. The first time the TeamViewer is launched, this ID is generated automatically based on the hardware characteristics and will not change later on.

Follow the steps below to receive remote support from a partner:

1. On the Home screen, tap **Other modules -> TeamViewer**. The TeamViewer interface displays and the device ID is generated and shown.

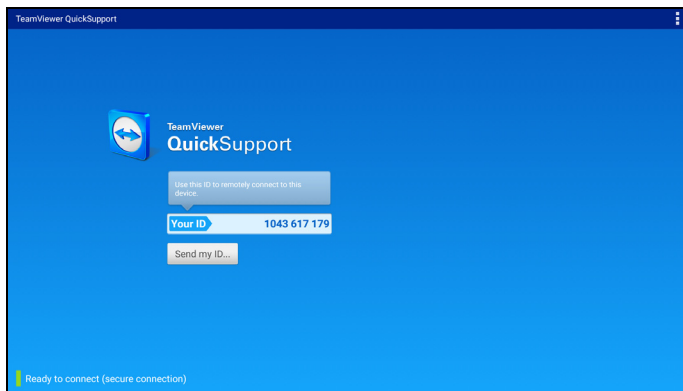

Fig. 15-2

2. Your partner must install the TeamViewer full version program (if not installed, go to <http://www.teamviewer.com> to download it), and then start the software on his/her computer at the same time, in order to provide support and take control of your tablet remotely.
3. Provide your ID to the partner, and wait for him/her to send you a remote control request.
4. A dialog box asking for your confirmation to allow remote control on your tablet will appear.
5. Tap **Allow** to accept, or tap **Deny** to reject.

For more information, please refer to the associated TeamViewer documents.

15.4 System OTA Upgrade

An Over-the-Air (OTA) update is the wireless delivery of new operating system, software or data to tablets and mobile phones. Wireless carriers have traditionally used over-the-air updates to deploy firmware and configure phones or tablets for use on their network. The initialization of a newly purchased tablet required an over-the-air update.

*Note: While performing OTA update, please make sure the tablet battery has at least 70% and DO NOT run any other programs during the update.

1. On the Home screen, tap **Other modules -> System OTA Upgrade**.
2. Tap "Check the Latest Version". Once a newer version is found, follow the

on-screen instructions to download and install the update file.

3. Be patient to wait until the update is done.

15.5 Facebook

Facebook is an American online social media and social networking service application. After registering, users can

- Create a customized profile indicating their name, occupation, schools attended and so on.
- Add other users as “friends”, exchange messages, post status updates, share photos, videos and links, use various app, and receive notifications of other users’ activity.
- Join common-interest user groups organized by workplace, school, hobbies or other topics, and categorize their friends into lists such as “People From Work” or “Close Friends”.
- Report or block unpleasant people.

For additional information on Facebook, please refer to the associated Facebook documents.

15.6 Wallet

Wallet App is a point (token) management application tailored for healthy vehicle maintenance. Those who share the Wallet App with car owner will be rewarded 1 point (token) when this car owner successfully registered. Later, the points will bring many unexpected benefits to you and the recommender. For example, use the points to redeem merchandise or enjoy discount.

15.6.1 Registering Wallet

Refer to Chapter 4.2.1 for details.

15.6.2 How to Obtain Wallet Tokens

There are 3 ways available to gain the points.

Approach 1: Activate the device and register a Wallet account

Refer to Chapter 4.2.1 for detailed user registration operation.

Approach 2: Recommend the car owner to download and register Wallet App

1. Tap “Recommend owners bonus token” on the Home screen, tap  to scan the vehicle’s VIN or enter the VIN manually in the input box.

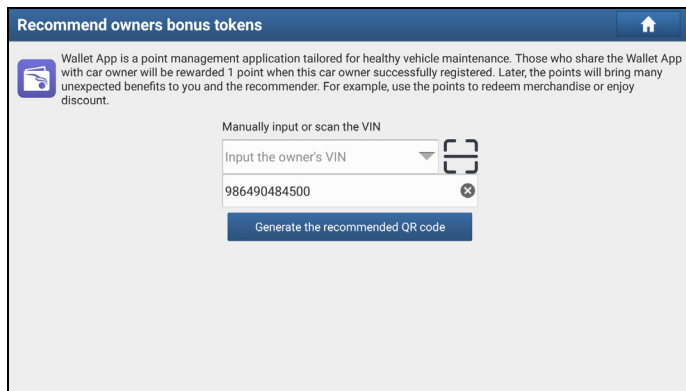

Fig. 15-3

2. Tap “Generate the recommended QR code”, and then inform the car owner to scan it to register.

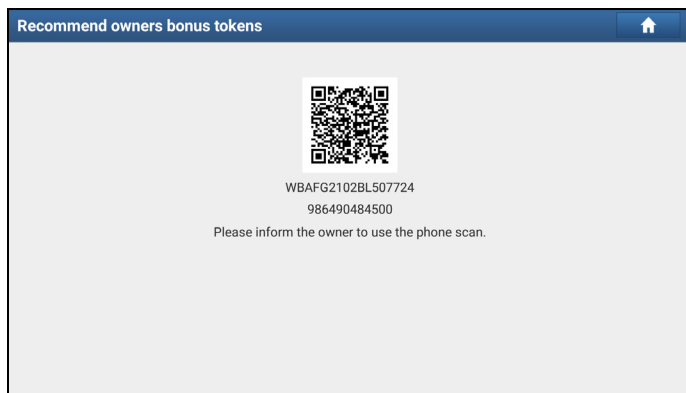

Fig. 15-4

Approach 3: Optimize the diagnostic reports

Tap “Reward for optimized report” in “User Info”, and then tap “Optimize report” to fill in the fault symptom, description and repair resolution.

15.6.3 Checking Wallet Tokens

Approach 1:

Go to “Personal Center” -> “CDB Token” to check the total token.

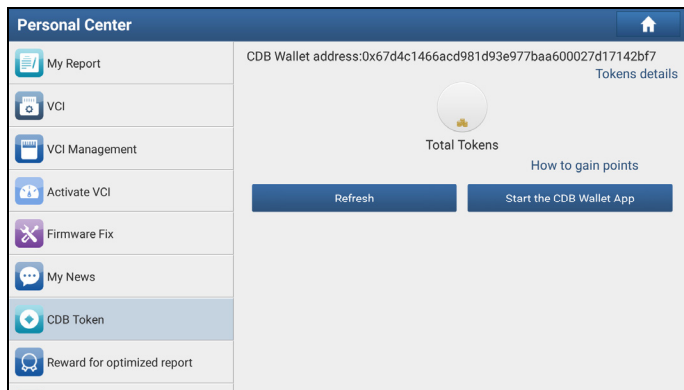

Fig. 15-5

Tap “Token details” to view how & when to get it.

Approach 2:

Tap “Start the CDB Wallet App” to navigate to the main menu screen of the Wallet App to check the tokens.

15.6.4 How to Backup Wallet Tokens

1. If no Wallet App is installed on the device, the system will prompt you to download the App before performing backup. Follow the instructions on the screen to download and install it. Open it and tap “Profile” (*Note: If the Wallet App has already been installed on the device, tap “OK” to import the Wallet data).

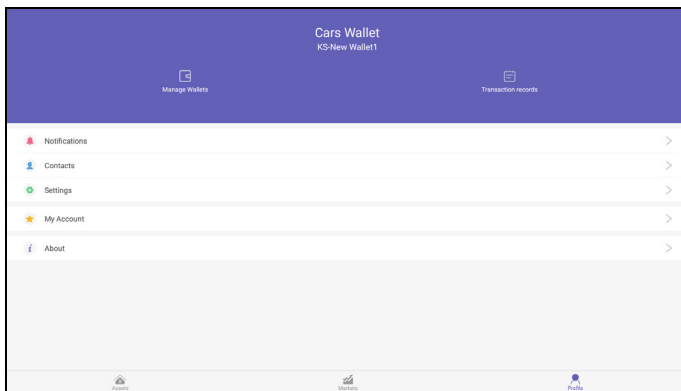

Fig. 15-6

2. Tap “Manage Wallets”.

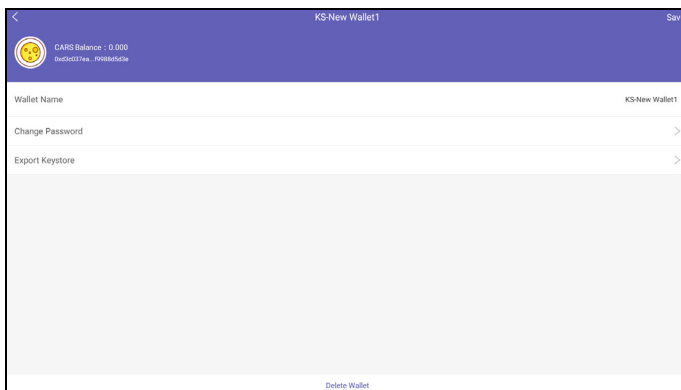

Fig. 15-7

3. Tap “Export Keystore”.

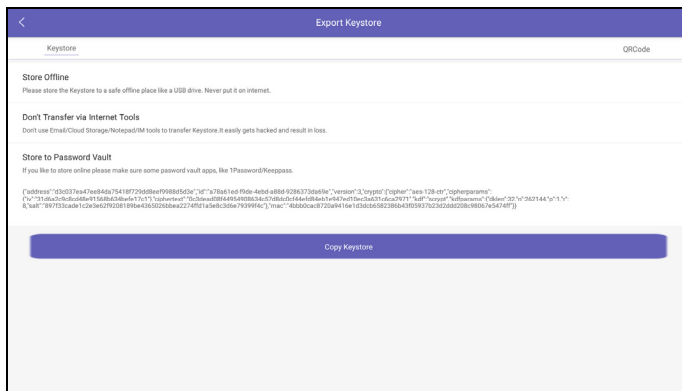

Fig. 15-8

4. Input the password.
5. Tap “Copy Keystore” and follow the prompts to select any one of the methods to save the keystore.

15.7 ES File Explorer

ES File Explorer is a file and application manager. You can access and create folders on the tablet without needing to connect it to a computer.

The app also features an application manager, task killer and download manager. Another excellent feature is support for cloud storage accounts. This means you can download files directly to the folders you want without using a separate app.

The app has built-in ZIP and RAR sources, so you can access compressed files without unpacking them on your computer first.

For more information, please refer to the associated ES file explorer documents.

15.8 Album

This function allows you to take new pictures and manage the picture library (including screenshots).

15.9 Synchronization

You can transfer media files and APK between the tablet and a computer.

1. Use the USB cable to connect the tablet and a computer.
2. Swipe the screen from the top, tap “USB connected”.
3. Tap “TURN ON USB STORAGE”.

Now you can copy files between the tablet and the computer.

16 FAQ

1. How to save power?

- Please turn off the screen while the tablet keeps idle.
- Set a shorter standby time.
- Decrease the brightness of the screen.
- If WLAN connection is not required, please turn it off.
- Disable GPS function if GPS service is not in use.

2. What should I do in case I forgot the screen lock?

You can set screen lock as pattern or password. If you forgot the password, please consult your device provider or reset your device.

 Warning: Resetting may cause data loss. Before use, please make sure important data has been backed up.

3. How to do if the system runs slow?

In this case, please do the followings:

- > Check all running applications and stop the unnecessary applications (Steps: Settings -> Apps -> Running -> Tap the desired application and then tap "Stop").
- > Check all installed applications, remove the unnecessary applications (Steps: Settings -> Apps -> Downloaded -> Tap the desired application and then tap "Uninstall").

If all steps mentioned above are finished and the system still works slowly. Please try to close the system and reboot the tablet.

4. How to reset the tablet?

 Resetting may cause data loss. Before doing so, please make sure important data and information has been backed up.

Do the following to reset the tablet:

1. Tap "Settings" -> "Back & Reset".
2. Tap "Factory data reset".
3. Tap "Reset tablet".

4. Tap “Clear all data” to start resetting until the tool automatically reboots.

5. How to Activate new VCI device?

Note: Before registration, please make sure the network is properly connected.

- A. If this is the first time using the handset, please refer to “Chapter 4.2.1” in the user manual for product registration.
- B. If you have activated a VCI device before, but bought a new VCI device due to the loss or other reasons, please follow the below steps to activate:
 1. On the Home screen, tap “Personal Center” -> “Activate VCI”.
 2. Input product S/N and activation code, which can be found from the included password envelope, then tap “Activate”.
 3. After activation completed, tap “Personal Center “ -> “My VCI” to check if the activated VCI device is displayed in the connector list or not. Multiple VCI devices can be bound to one tool. If you intend to use one of the VCI devices to diagnose or test a vehicle, just switch to the corresponding VCI device.

6. How to update the APK and diagnostic software?

1. On the Home screen, tap “Software Upgrade”.
2. Tap “Select all” if all the software needs to be downloaded. To cancel the selection of certain software, just click the check box before it. Tap “Update” on the bottom of the screen to start the download. During the upgrade, please make sure the handset has a stable network connection.

7. How to pair the VCI device with the tablet?

Users can pair the VCI device with the tablet via Bluetooth when testing the vehicle or in system settings.

1. Turn the ignition on.
2. Plug the VCI device (or use the OBD-II extension cable to connect the VCI device and the VCI) into the vehicle’s DLC.
3. On the Home screen, tap **Setting -> Bluetooth**.
4. Set Bluetooth “ON”. The tablet will search for all the available Bluetooth devices automatically.
5. Tap the name of the VCI device (98*****00, where ***** stands for 8 digits) to start pairing. Input the Bluetooth request code (default value: 0000 or 1234)

if necessary. Once the pairing is properly done, the system will display it as a paired device.

8. How to set up a network connection?

There are 2 kinds of network connection available on the tablet.

A. Wired Connection

Connect the Ethernet cable to the tablet directly.

B. Connect to a Wi-Fi network

The tablet has built-in Wi-Fi that can be used to get online. Once you're online, you can register your tablet, browse the Internet, get and update apps and send email on your network.

Note: Once WLAN is set as ON, the tablet will consume more power. While WLAN keeps unused, please turn it off to conserve battery power.

1. On the Home screen, tap **Settings** -> **Wi-Fi**.
2. Tap or slide the Wi-Fi switch to ON, the tablet starts searching for all available wireless LANs.
3. Choose the desired Wi-Fi access point / network,
 - If the network you chose is open, you can connect directly;
 - If the selected network is encrypted, you have to enter the right security key (network password).

9. How to retrieve the login password?

Please follow below steps to proceed in case you forgot the login password:

1. Tap [Login] button on the upper right corner of the screen.

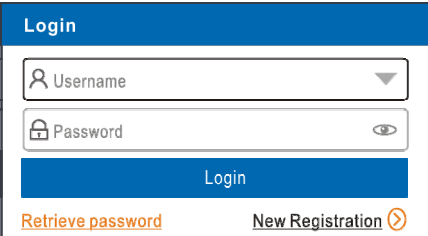

The screenshot shows a login interface with a blue header labeled "Login". Below the header are two input fields: "Username" with a person icon and a dropdown arrow, and "Password" with a lock icon and an eye icon. A blue "Login" button is positioned below the password field. At the bottom, there are two links: "Retrieve password" in orange text and "New Registration" in blue text with a right-pointing arrow icon.

2. Tap "Retrieve password".

| | |
|--|-----------------------------------|
| Please input product S/N | Username (automatically obtained) |
| Email address (automatically obtained) | |
| Get verification code by email | Enter Validation Code |
| New Password | Confirm Password |
| Reset Password | |

3. Input product S/N and follow the on-screen prompts to retrieve the password.

Warranty

THIS WARRANTY IS EXPRESSLY LIMITED TO PERSONS WHO PURCHASE LAUNCH PRODUCTS FOR PURPOSES OF RESALE OR USE IN THE ORDINARY COURSE OF THE BUYER'S BUSINESS.

LAUNCH electronic product is warranted against defects in materials and workmanship for one year from date of delivery to the user.

This warranty does not cover any part that has been abused, altered, used for a purpose other than for which it was intended, or used in a manner inconsistent with instructions regarding use. The exclusive remedy for any automotive meter found to be defective is repair or replacement, and LAUNCH shall not be liable for any consequential or incidental damages.

Final determination of defects shall be made by LAUNCH in accordance with procedures established by LAUNCH. No agent, employee, or representative of LAUNCH has any authority to bind LAUNCH to any affirmation, representation, or warranty concerning LAUNCH automotive meters, except as stated herein.

Disclaimer

The above warranty is in lieu of any other warranty, expressed or implied, including any warranty of merchantability or fitness for a particular purpose.

Purchase Order

Replaceable and optional parts can be ordered directly from your LAUNCH authorized tool supplier. Your order should include the following information:

Order quantity

Part number

Part name

Customer Service

Any question during the operation, please call 86-755-84528722.

If your unit requires repair service, return it to the manufacturer with a copy of the sales receipt and a note describing the problem. If the unit is determined to be in warranty, it will be repaired or replaced at no charge. If the unit is determined to be out of warranty, it will be repaired for a nominal service charge plus return freight. Send the unit pre-paid to:

Attn: Customer Service Department

LAUNCH TECH. CO., LTD.

Launch Industrial Park,

North of Wuhe Avenue,
Banxuegang, Bantian,
Longgang, Shenzhen, Guangdong
P.R.China, 518129
Launch website: <http://www.cnlaunch.com>
<http://www.x431.com>

Statement:

LAUNCH reserves the rights to make any change to product designs and specifications without notice. The actual object may differ a little from the descriptions in the manual in physical appearance, color and configuration. We have tried our best to make the descriptions and illustrations in the manual as accurate as possible, and defects are inevitable, if you have any question, please contact local dealer or after-sale service center of LAUNCH, LAUNCH does not bear any responsibility arising from misunderstandings.