

Version: V1.00.001
Revised date: 07-09-2020

Statement: LAUNCH owns the complete intellectual property rights for the software used by this product. For any reverse engineering or cracking actions against the software, LAUNCH will block the use of this product and reserve the right to pursue their legal liabilities.

Copyright Information

Copyright © 2020 by LAUNCH TECH CO., LTD. All rights reserved. No part of this publication may be reproduced, stored in a retrieval system, or transmitted in any form or by any means, electronic, mechanical, photocopying, recording or otherwise, without the prior written permission of LAUNCH. The information contained herein is designed only for the use of this unit. LAUNCH is not responsible for any use of this information as applied to other units.

Neither LAUNCH nor its affiliates shall be liable to the purchaser of this unit or third parties for damages, losses, costs, or expenses incurred by purchaser or third parties as a result of: Accident, misuse, or abuse of this unit, or unauthorized modifications, repairs, or alterations to this unit, or failure to strictly comply with LAUNCH operating and maintenance instructions. LAUNCH shall not be liable for any damages or problems arising from the use of any options or any consumable products other than those designated as Original LAUNCH Products or LAUNCH Approved Products by LAUNCH.

Trademark Information

LAUNCH is a registered trademark of LAUNCH TECH CO., LTD. (LAUNCH) in China and other countries. All other LAUNCH trademarks, service marks, domain names, logos, and company names referred to in this manual are either trademarks, registered trademarks, service marks, domain names, logos, company names of or are otherwise the property of LAUNCH or its affiliates. In countries where any of the LAUNCH trademarks, service marks, domain names, logos and company names are not registered, LAUNCH claims other rights associated with unregistered trademarks, service marks, domain names, logos, and company names. Other products or company names referred to in this manual may be trademarks of their respective owners. You may not use any trademark, service mark, domain name, logo, or company name of LAUNCH or any third party without permission from the owner of the applicable trademark, service mark, domain name, logo, or company name. You may contact LAUNCH by visiting the website at www.cnlaunch.com, or writing to LAUNCH TECH CO., LTD., Launch Industrial Park, North of Wuhe Avenue, Banxuegang, Bantian, Longgang, Shenzhen, Guangdong, P.R.China, to request written permission to use Materials on this manual for purposes or for all other questions relating to this manual.

Important Safety Precautions

Important: To avoid personal injury, property damage, or accidental damage to the product, read all of the information in this section before using the product.

- Never collide, throw, or puncture the tool, and avoid falling, extruding and bending it.
- Do not insert foreign objects into or place heavy objects on your device. Sensitive components inside might cause damage.
- Do not use the tool in exceptionally cold or hot, dusty, damp or dry environments.
- In places using the tool may cause interference or generate a potential risk, please turn it off.
- This tool is a sealed unit. There are no end-user serviceable parts inside. All internal repairs must be done by an authorized repair facility or qualified technician. If there is any inquiry, please contact the dealer.
- Never place the tool into apparatus with strong electromagnetic field.
- Keep the tool far away from magnetic devices because its radiations can damage the screen and erase the data stored on the tool.
- DANGER: Do not attempt to replace the internal rechargeable lithium battery. Contact the dealer for factory replacement.
- CAUTION: Please use the included battery and charger. Risk of explosion if the battery is replaced with an incorrect type.

Precautions on Using This Tool

Before using this tool, please read the following safety information carefully.

- Always perform automotive testing in a safe environment.
- If the VCI (Vehicle Communication Interface) device is not in use for a long period of time, it is suggested to unplug the connector from vehicle's DLC to conserve battery power.
- Wear an ANSI-approved eye shield when testing or repairing vehicles.
- The vehicle shall be tested in a well-ventilated work area, as engines produce various poisonous compounds (hydrocarbon, carbon monoxide, nitrogen oxides, etc.)
- Do not connect or disconnect any test equipment while the ignition is on or

the engine is running.

- Put blocks in front of the drive wheels and never leave the vehicle unattended while testing.
- Keep the tool dry, clean, free from oil, water or grease. Use a mild detergent on a clean cloth to clear the outside of the equipment as necessary.
- Do not drive the vehicle and operate the tool at the same time. Any distraction may cause an accident.
- Keep clothing, hair, hands, tools, test equipment, etc. away from all moving or hot engine parts.
- Before starting the engine, put the gear lever in the Neutral position (for manual transmission) or in the Park (for automatic transmission) position to avoid injury.
- To avoid damaging the tool or generating false data, please make sure the vehicle battery is fully charged and the connection to the vehicle DLC (Data Link Connector) is clear and secure.
- Automotive batteries contain sulfuric acid that is harmful to skin. In operation, direct contact with the automotive batteries should be avoided. Keep the ignition sources away from the battery at all times.

Precautions on Operating Vehicle's ECU

- Do not disconnect battery or any wiring cables in the vehicle when the ignition switch is on, as this could avoid damage to the sensors or the ECU.
- Do not place any magnetic objects near the ECU. Disconnect the power supply to the ECU before performing any welding operations on the vehicle.
- Use extreme caution when performing any operations near the ECU or sensors. Ground yourself when you disassemble PROM, otherwise ECU and sensors can be damaged by static electricity.
- When reconnecting the ECU harness connector, be sure it is attached firmly, otherwise electronic elements, such as ICs inside the ECU, can be damaged.

TABLE OF CONTENTS

1 INTRODUCTION	1
1.1 PRODUCT PROFILE	1
1.2 FEATURES	1
1.3 COMPONENTS & CONTROLS	2
1.3.1 DISPLAY TABLET	2
1.3.2 VCI CONNECTOR	5
1.4 TECHNICAL SPECIFICATIONS	8
1.4.1 DISPLAY TABLET	8
1.4.2 VCI DEVICE	8
1.5 PACKING LIST	9
1.5.1 PASSENGER VEHICLE CONFIGURATION	9
1.5.2 COMMERCIAL VEHICLE CONFIGURATION	10
2 PREPARATIONS	12
2.1 CHARGING THE TABLET	12
2.2 USING BATTERY	12
2.3 POWER ON AND OFF	12
2.3.1 POWER ON	12
2.3.2 POWER OFF	12
2.4 TIPS ON FINGER OPERATIONS	13
2.5 ONSCREEN KEYS	13
2.6 ADJUST BRIGHTNESS	13
2.7 CHANGE SYSTEM LANGUAGE	14
2.8 SET STANDBY TIME	14
3 NETWORK SETUP	15
3.1 CONNECT TO A WI-FI NETWORK	15
3.2 DISCONNECT FROM A WI-FI NETWORK	15

4 INITIAL USE	16
4.1 DIAGNOSIS FLOWCHART	16
4.2 GET STARTED	16
4.2.1 USER REGISTRATION	16
4.2.2 JOB MENU	19
4.2.3 DIAGNOSTICS TOOLBAR	20
4.3 CONNECTIONS	21
4.3.1 PREPARATION	21
4.3.2 DLC LOCATION	21
5 DIAGNOSIS	25
5.1 INTELLIGENT DIAGNOSE	25
5.2 LOCAL DIAGNOSE	29
5.2.1 HEALTH REPORT (QUICK TEST)	35
5.2.2 SYSTEM SCAN	39
5.2.3 SYSTEM SELECTION	40
5.3 REMOTE DIAGNOSE	52
5.3.1 INTERFACE LAYOUT	52
5.3.2 ADD FRIENDS	53
5.3.3 START INSTANT MESSAGING	54
5.3.4 LAUNCH REMOTE DIAGNOSIS (DEVICE-TO-DEVICE)	56
5.3.5 LAUNCH REMOTE DIAGNOSIS (DEVICE-TO-PC)	58
5.4 FEEDBACK	61
5.5 DIAGNOSTIC HISTORY	63
6 SPECIAL (RESET) FUNCTION	65
6.1 OIL RESET SERVICE	66
6.2 ELECTRONIC PARKING BRAKE RESET	66
6.3 STEERING ANGLE CALIBRATION	67

6.4 ABS BLEEDING	67
6.5 TIRE PRESSURE MONITOR SYSTEM RESET	67
6.6 GEAR LEARNING	67
6.7 IMMO SERVICE	68
6.8 INJECTOR CODING	68
6.9 BATTERY MAINTENANCE SYSTEM RESET	69
6.10 DIESEL PARTICULATE FILTER (DPF) REGENERATION.....	69
6.11 ELECTRONIC THROTTLE POSITION RESET	70
6.12 GEARBOX MATCHING.....	70
6.13 AFS (ADAPTIVE FRONT-LIGHTING SYSTEM) RESET	70
6.14 SUNROOF INITIALIZATION	70
6.15 SUSPENSION CALIBRATION.....	70
7 SOFTWARE UPDATE	71
7.1 UPDATE DIAGNOSTIC SOFTWARE	71
7.2 SET FREQUENTLY USED SOFTWARE	71
7.3 RENEW SUBSCRIPTION	72
8 MY REPORT.....	74
9 USER INFO	77
9.1 VCI.....	77
9.2 VCI MANAGEMENT FOR PASSENGER VEHICLE CONFIGURATION.....	77
9.3 VCI MANAGEMENT FOR COMMERCIAL VEHICLE CONFIGURATION.....	77
9.4 ACTIVATE VCI.....	79
9.5 FIRMWARE FIX	80
9.6 MY NEWS	80
9.7 DATA STREAM SAMPLE	80
9.8 MY ORDER	80
9.9 SUBSCRIPTION RENEWAL CARD.....	80
9.10 PROFILE	81
9.11 CHANGE PASSWORD	81

9.12 SETTINGS	81
9.12.1 UNITS	81
9.12.2 SHOP INFORMATION	81
9.12.3 PRINTER SET	82
9.12.4 ORIENTATION	85
9.12.5 CLEAR CACHE.....	85
9.12.6 ABOUT	85
9.12.7 DIAGNOSTIC SOFTWARE AUTO UPDATE	85
9.12.8 LOGIN/LOGOUT	85
9.13 DIAGNOSTIC SOFTWARE CLEAR.....	86
10 VIDEOSCOPE	87
10.1 INTRODUCTION.....	87
10.2 CONNECTIONS & OPERATIONS	87
11 SYNCHRONIZATION.....	88
12 FAQ.....	90

1 Introduction

1.1 Product Profile

The android-based X-431 V+ diagnostic tool is designed to support several vehicle configurations consisting commercial vehicle and passenger vehicle, it features powerful functions and test result accuracy through LAUNCH's advanced diagnosing technology and wide range of vehicles coverage.

With the simple Bluetooth or Wi-Fi communication (only for Commercial Vehicle Configuration) communication between VCI (Vehicle Communication Interface) device and the display handset, the product has achieved full car model and full system vehicle trouble diagnosis, which include Reading DTCs, Clearing DTCs, Reading Data Stream, Actuation Test and Special Functions. Taking advantage of the mobile Internet, it also integrates One-click Update, Remote Diagnosis, Repair Data and golo Business Manager, which helps to diagnose vehicle issues more efficiently, and greatly increase customer's retention ratio and boost shop revenue.

1.2 Features

- **Intelligent Diagnose**: This module allows you to use the VIN information of the currently identified vehicle to access its data (including vehicle information, historical diagnostic records) from the cloud server to perform quick test.
- **Local Diagnose**: Follow the on-screen prompts to start diagnostic session step by step. Diagnosis functions include: Read DTCs, Clear DTCs, Read Data Stream, Special Functions etc.
- **Remote Diagnose**: This option aims to help repair shops or technicians launch instant messaging and remote diagnosis, making the repair job getting fixed faster.
- **Reset**: All kinds of common maintenance and reset items including Oil lamp reset, DPF regeneration, ABS bleeding etc. can be done.
- **One-click Update**: Lets you update your diagnostic software online.
- **Diagnostic History**: This function provides a quick access to the tested vehicles and users can choose to view the test report or resume from the last operation, without the necessity of starting from scratch.

- **Feedback:** Enables you to submit the vehicle issue to us for analysis and troubleshooting.
- **Vehicle Coverage:** Quick dial to view the vehicle models that the tool covers.
- **My Report:** Optional. This function enables you to view, delete or share the saved diagnostic reports.

1.3 Components & Controls

The diagnostic system has two main components:

- Display Tablet – the central processor and monitor for the system (See Chapter “1.3.1”).
- VCI Device – the device for accessing vehicle data (See Chapter “1.3.2”).

The tablet acts as the central processing system, which is used to receive and analyze the live vehicle data from the VCI device and then output the test result.

1.3.1 Display tablet

Passenger vehicle and commercial vehicle configuration are provided for X-431 V+ V4.0.

The passenger vehicle configuration is shown as below:

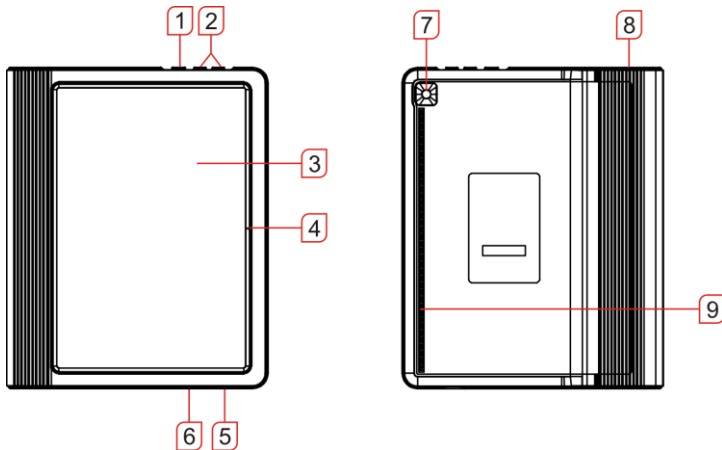

1	POWER Key	<p>In Off mode, press it for 3 seconds to turn the handset on.</p> <p>In On mode:</p> <ul style="list-style-type: none"> • Press it once to activate the LCD if the LCD is off. • Press it once to turn off the LCD if the LCD lights up. • Press and hold it for 3 seconds to turn it off. • Press and hold it for 8 seconds to perform forced shutdown.
2	Volume +/-	Adjusts the system volume.
3	LCD Screen	Indicates the test results.
4	Front Camera	Support taking photographs
5	USB/Charging Port	<ul style="list-style-type: none"> • To connect to AC outlet for charging. • To connect to PC for data exchange.
6	Microphone	Support sound transmission
7	Rear Camera	Support taking photographs
8	Docking slot for VCI	<p>For housing the VCI.</p> <p>The VCI is pre-installed in this slot on the back of the display tablet. Use the hand to press the VCI once, it will automatically ejected from the docking slot.</p> <p>When the VCI is not in use, please insert it into this slot to avoid loss.</p>
9	Speakers	Support sound play

The commercial vehicle configuration is shown as below:

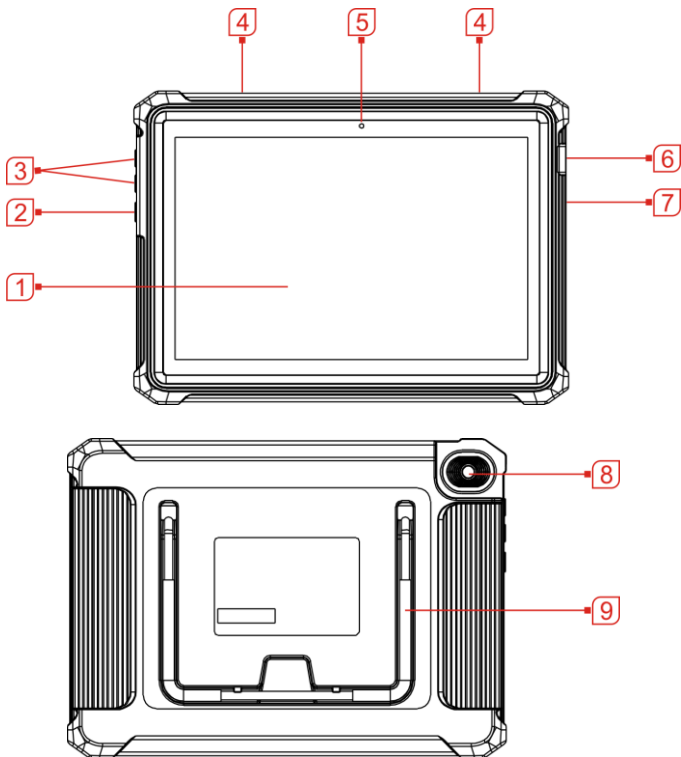

1 LCD Screen

Indicates the test results.

In Off mode, press it for 3 seconds to turn the handset on.

In On mode:

2 POWER Key

- Press it once to activate the LCD if the LCD is off.
 - Press it once to turn off the LCD if the LCD lights up.
 - Press and hold it for 3 seconds to turn it off.
-

- Press and hold it for 8 seconds to perform forced shutdown.

3	Volume +/-	Adjusts the system volume.
4	Speakers	Support sound play
5	Front Camera	Support taking photographs
6	USB/Charging Port	<ul style="list-style-type: none">• To connect to AC outlet for charging.• To connect to PC for data exchange.
7	Microphone	Support sound signal transmission
8	Rear Camera	Support taking photographs
9	Adjustable stand	Flip it out to any angle and work comfortable at your desk, or hang it on steering wheel.

1.3.2 VCI connector

VCI connector for Passenger Vehicle Configuration:

The VCI works as a vehicle communication interface device, which is used to connect to the vehicle's DLC (Data Link Connector) socket directly or via OBD II extension cable to read the vehicle data and then send it to the tablet via Bluetooth.

It is pre-installed in the docking slot on the back of the display tablet. Use the hand to press the VCI once, it will be automatically ejected from the docking slot. When it is not in use, please reinsert it into the slot to avoid loss.

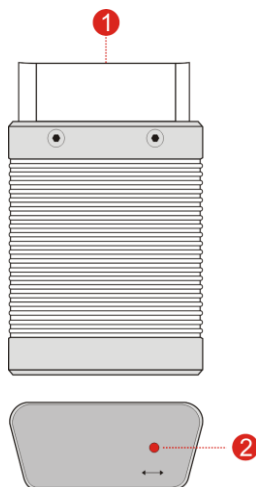

1 **OBD-16 diagnostic connector**

To connect on vehicle's OBD II DLC.

2 **Mode indicator**

- It illuminates red when the VCI device is connected to the vehicle's DLC.
- Blue indicates the VCI device is working in wireless (BT) communication mode.

VCI connector for Commercial Vehicle Configuration:

Compatible with commercial & passenger vehicles, the VCI module works as a vehicle communication interface device. It is used to read the vehicle data and then send it to the tablet via Bluetooth/Wi-Fi communication or USB cable connection. The LED indicators enable you to easily identify the working status of the module.

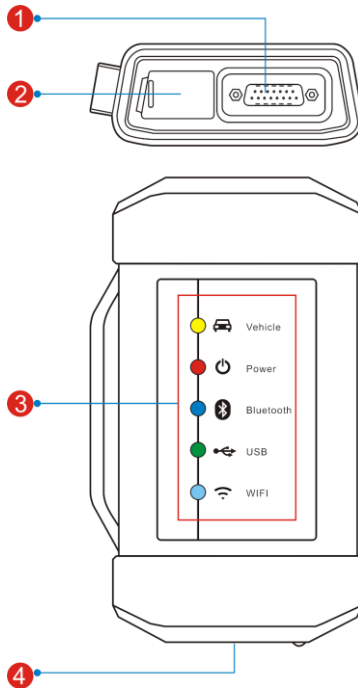

1 **Diagnostic socket** Connects the diagnostic cable

2 **DC-IN power jack** Connects the cigarette lighter cable / battery clamps cable.

3 **LED Indicators**

It is defined as follows:

- **Vehicle:** While communicating with the vehicle, the indicator lights up and flashes. Otherwise, it will not illuminate.
- **Power:** It illuminates solid red when the module is powered on.
- **Bluetooth:** Blue indicates the module is working in Bluetooth mode.
- **USB:** It lights up when the module is

connected to the diagnostic tool via USB cable (Currently disabled and only reserved for subsequent function extension).

Wi-Fi: It lights up when the module works as a Wi-Fi hotspot or wireless adaptor.

4	USB port	Currently disabled and only reserved for subsequent function extension.
----------	-----------------	---

1.4 Technical Specifications

1.4.1 Display tablet

Operating system	Android
Memory	3GB
Storage	32GB
Screen	10.1 inch FHD IPS capacitive touch screen with a resolution of 1920 x 1200 pixels
Camera	Front-facing 5.0MP + Rear-facing 8.0MP camera
Connectivity	<ul style="list-style-type: none"> • Wi-Fi (802.11a/b/g/n/ac) • Bluetooth
Working temperature	0°C ~ 50°C
Storage temperature	-20°C ~ 70°C

1.4.2 VCI device

VCI device for Passenger Vehicle Configuration are as below:

Working voltage	9 ~ 18V
Working temperature	0°C ~ 50°C
Relative humidity	20% ~ 90%

VCI device for Commercial Vehicle Configuration are as below:

Working voltage	DC 9 ~36V
Power consumption	≤ 3W
Communication	Via Bluetooth/Wi-Fi or USB connection
Working temperature	0°C ~ 50°C

1.5 Packing List

Accessories may vary depending on sales regions. Please consult local agency or check the package list supplied with this tool.

1.5.1 Passenger Vehicle Configuration

No.	Item	Descriptions	Qt.
1	Display tablet	Indicates the test result.	1
2	VCI connector	Collects the vehicle data and sends it to the tablet for analysis.	1
3	OBD II extension cable	To connect the VCI connector to the OBD II vehicle's DLC.	1
4	Password envelope	A piece of paper bearing the product Serial Number and Activation Code for product registration.	1
5	Power adaptor	For charging the tablet via AC outlet.	(Optional)
6	Battery clamps cable	To supply power to the non-16pin connector from the vehicle's battery.	(Optional)
7	Cigarette lighter cable	To supply power to the non-16pin connector from the vehicle's cigarette lighter receptacle.	(Optional)
8	USB cable		1

9	OBD I adaptor box	For connecting the VCI connector and non-16pin adaptor cable.	(Optional)
10	Non-16pin adaptor cable kit	To connect to the vehicle equipped with non-OBD II management system.	(Optional)

1.5.2 Commercial Vehicle Configuration



No.	Item	Descriptions	Qt.
1	Display tablet	The central processor and monitor for analyzing vehicle data and showing test results.	1
2	VCI module	A device for accessing vehicle live data.	1
3	Password envelope	A piece of paper bearing Product S/N and Activation Code, which is required for your registration.	1
4	Diagnostic cable	To connect the VCI module to vehicle's DLC.	1
5	Cigarette lighter cable	To supply power to the VCI module through connection to cigarette lighter receptacle.	(optional)
6	Battery clamps cable	To supply power to the VCI module through connection to vehicle's battery.	(optional)
7	Power adaptor	To charge the tablet through connection to AC outlet.	1
8	USB cable with B-shaped terminal	To connect the VCI module and diagnostic tool to perform vehicle diagnosis.	1
9	Non-16pin adaptor	For different vehicle diagnostic	(optional)

	cable kit	socket, it may be necessary to use one of the adaptor cables included within the kit. For detailed non-16pin adaptor cables, please check the package box.	
--	-----------	---	--

2 Preparations

2.1 Charging the Tablet

1. Plug one end of the included charging port of the tool, and the other end to the power adaptor.
2. Connect the other end to the AC outlet.

If  appears on the screen, it indicates it is being charged. If the logo changes into , it indicates that the battery is fully charged. Unplug the power adaptor from the tablet.

2.2 Using Battery

- ♦ If the battery remains unused for a long period of time or the battery is completely discharged, it is normal that the tool will not power on while being charged. Please charge it for a period of 5 minutes and then turn it on.
- ♦ Please use the included power adaptor to charge your tool. No responsibility can be assumed for any damage or loss caused as a result of using power adaptors other than the one supplied.
- ♦ While the tablet has low battery, a beep will sound. If it is very low, the tablet will be switched off automatically.

2.3 Power on and off

2.3.1 Power on

Press [POWER] to turn the tool on.



Note: If it is the first time you have used this tool or the tool remains idle for a long period of time, the tool could fail to turn on. Please charge the tool for a minimum of 5 minutes and attempt to turn on again.

2.3.2 Power off

Press [POWER] for 3 seconds, an option menu will pop up on the screen. Tap "Power off" to turn the tool off.

2.4 Tips on Finger Operations



Single-tap: To select an item or launch a program.



Double-tap: To zoom in so that the text on a webpage appears in a column that fits your device's screen.



Long press: Tap and hold on the current interface or area until a contextual menu pops up on the screen, and then release it.



Slide: To jump to different pages.



Drag: Tap the application icon and drop it to other location.



Spread apart/pinch together: To zoom in manually, place two fingers on the screen and then spread them apart. To zoom out, place two fingers apart on the screen and then pinch them together.

2.5 Onscreen Keys

The following on-screen buttons are available on the bottom of the screen.



BACK

Tap it to return to the previous screen.



HOME

Tap it to navigate to the Android's home screen.



Recent Apps

Tap it to view the recently launched applications.



Screenshot

Tap it to capture the current screen.

2.6 Adjust Brightness

 **Tips:** Reducing the brightness of the screen is helpful to conserve the battery power.

1. On the home screen, tap **Settings -> Display -> Brightness level**.

2. Drag the slider to adjust it.

2.7 Change System Language

The tool supports multiple system languages. To change the language of the tool, please do the following:

1. On the home screen, tap **Settings -> System -> Language & input -> Languages**.
2. Tap **Add a language**, and then choose the desired language from the list.
3. Tap and hold the desired language and drag it to the top of the screen and then release it, the system will change into the target language.

2.8 Set Standby Time

If no activity occurs within the defined standby period, the screen will be locked automatically and the system enters sleep mode to save power.

1. On the home screen, tap **Settings -> Display -> Advanced -> Sleep**.
2. Choose the desired sleep time.

3 Network Setup

 Note: If you don't need to use Wi-Fi for a while, you can turn it off to conserve battery life.

The tablet has built-in Wi-Fi that can be used to get online. Once you're online, you can register your tool, surf the Internet, get apps, send email, launch the remote diagnosis, and check for software updates etc.

3.1 Connect to a Wi-Fi Network

1. On the home screen, tap **Settings -> Network & Internet -> WLAN**.
2. Slide the Wi-Fi switch to ON, the tablet starts searching for available wireless networks.
3. Select a wireless network,
 - If the chosen network is open, the tablet will connect automatically.
 - If the selected network is encrypted, a network password will need to be entered.
4. When "Connected" appears, it indicates the Wi-Fi connection is complete.

 Note: When Wi-Fi is not required, this should be disabled to conserve battery power.

Once it is connected successfully, tap the desired Wi-Fi network from the list to view its name, link speed, security type, IP address etc.

When this tool is in range, it will connect to the previously linked network automatically.

3.2 Disconnect from a Wi-Fi Network

1. On the home screen, tap **Settings -> Network & Internet -> WLAN**.
2. Tap the network with a **Connected** status, then tap "Disconnect".

4 Initial Use

4.1 Diagnosis Flowchart

For new users, please follow the operation chart shown as below to get familiar with and start using this tool.

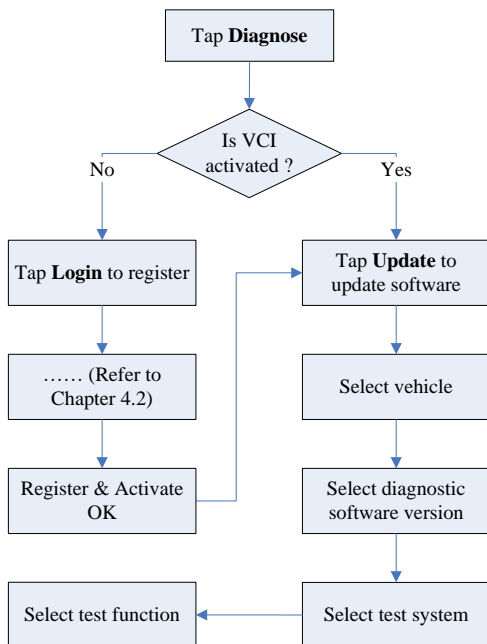

4.2 Get Started

4.2.1 User Registration

For initial use, the registration is the necessary first procedure to activate the tool.

Tap the application icon on the home screen to launch it, and then tap **Login** to enter the following login screen.

(If you are a new user, follow **A** to proceed.)

(If you have registered to be a member, go to **B** to login the system directly.)

(In case you forgot password, refer to **C** to reset a new password.)

A. If you are a new user, tap **New Registration** to enter the sign-up page.

In the above figure, fill in the information in each field (Items with * must be filled). After inputting, tap **Register**, a screen similar to the following will appear:

Input the Serial Number and Activation Code, which can be found in the password envelope.

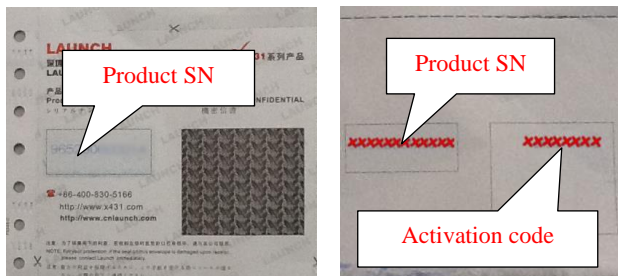

Note: To exit and activate it later, tap **Skip**. In this case, please activate the VCI module by tapping **User Info** -> **Activate VCI**. For details, please refer to Chapter 9.4 Activate VCI.

Tap **Activate** to finish your registration.

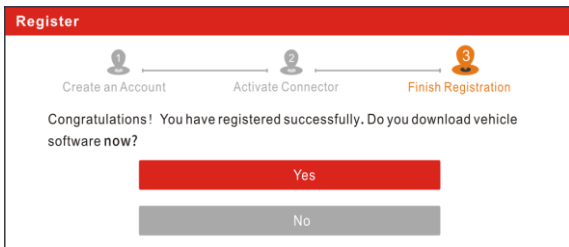

To download the diagnostic software, tap **Yes** to enter the update page.

Tap **No** to download and install it later in the Software Update.

On the download screen, tap **Update** to start downloading. To pause downloading, tap **Stop**. To resume it, tap **Continue**.

Once download is complete, the system will install the software package automatically.

Note: In process of download, please make sure it is properly connected to the WLAN network. It may take several minutes to finish it, please be patient to wait.

B. If you have registered to be a member, input your name and password, and then tap the **Login** button to enter the main menu screen directly.

 Note: After the username and password are entered the first time, the system's auto-save function automatically stores it. After initial setup it is no longer necessary to input the account information automatically to log in.

C. If you forgot the password. tap **Retrieve password** and then follow on-screen instructions to set a new password.

4.2.2 Job Menu

After logging in, the **Login** button will change into the  button. It mainly includes the following items:



Name	Description
Intelligent Diagnose	This module allows you to obtain vehicle data from the cloud server to perform quick test via reading VIN, which provides a perfect solution to various defects resulting from step-by-step menu selection. In addition, user can also check the historical repair records online through this module.
Local Diagnose	To diagnose a vehicle manually.
Reset	To perform all kinds of common repair & maintenance items, including electronic throttle position reset, ABS bleeding, oil lamp reset etc.
Software Update	To update vehicle diagnostic software and APK.
Diagnostic History	Generally once a vehicle diagnosis is performed, the tablet will automatically save every details of diagnostic process. This function provides a quick access to the tested vehicles and users can resume from the last operation, without the necessity of starting from scratch.
Feedback	To feed back the recent 20 diagnostic logs to us for issue analysis.
Remote Diagnose	This helps repair shops or mechanics to diagnose a remote vehicle, and launch instant messages, allowing for improved efficiency and faster repairs.

My Report	This function enables you to view, delete or share the saved diagnostic reports.
Mall	An online diagnostic software store. This module enables you to subscribe some extra software or service functions that are not integrated in the tool online.
Vehicle Coverage	To view all the vehicle models that the tool covers.
Maintenance	Abundant maintenance data are available, which helps repair professionals diagnose and repair vehicles efficiently, accurately and profitably.
User Info	To manage my connector, my reports, change password, configure Wi-Fi printer, configure system settings and logout etc.
Other Modules	Includes Videoscope, product manual, FAQ and some system Apps etc.

4.2.3 Diagnostics Toolbar

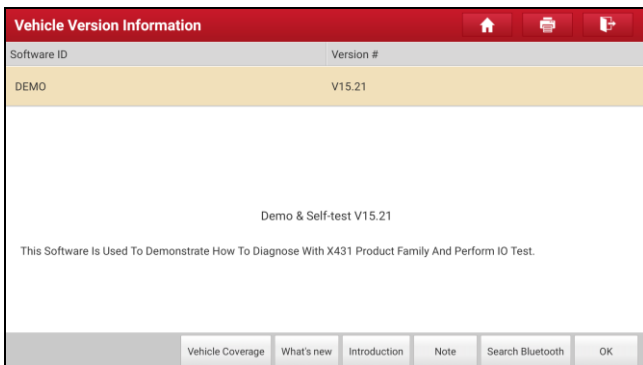
The diagnostics toolbar contains a number of buttons that allow you to print the displayed data or make other controls. It is displayed on the upper right corner of the screen and goes through the whole diagnostic session. The table below provides a brief description for the operations of the diagnostics toolbar buttons:



Name	Button	Description
Home		Returns to Job menu screen.
Print		Touch to print the selected screenshots out via external printer. The printer needs to be configured separately. For details on printer setting, refer to Chapter 9.12.3.
Exit		To exit the diagnostic application.

4.3 Connections

4.3.1 Preparation

Normal testing conditions

- Turn on the vehicle power supply.
- Vehicle battery voltage range should be 9-14V or 18-30V.
- Throttle should be closed at its close position.

4.3.2 DLC location

The DLC (Data Link Connector or Diagnostic Link Connector) is typically a standard 16-pin connector where diagnostic code readers interface with the vehicle's on-board computer. The DLC is usually located 12 inches from the center of the instrument panel (dash), under or around the driver's side for most vehicles. If DLC is not located under dashboard, a label should be there telling location. For some Asian and European vehicles, the DLC is located behind the ashtray and the ashtray must be removed to access the connector. If the DLC cannot be found, refer to the vehicle's service manual for the location.

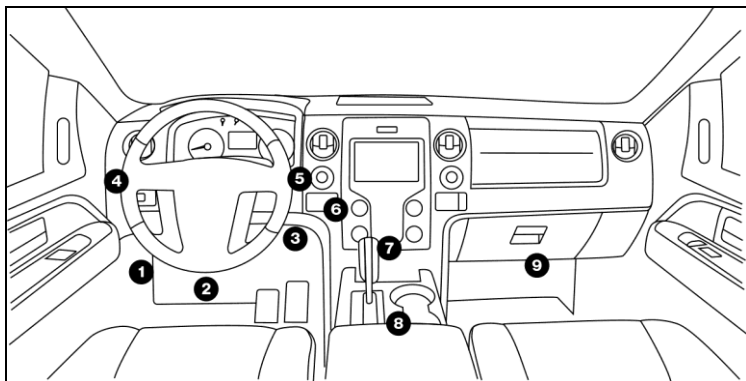

Vehicle Connection (For Passenger Vehicle Configuration):

The method used to connect the VCI device to a vehicle's DLC depends on the vehicle's configuration as follows:

- A vehicle equipped with an OBD II management system supplies both communication and 12V power through a standardized DLC.
- A vehicle not equipped with an OBD II management system supplies communication through a DLC connection, and in some cases supplies 12V power through the cigarette lighter receptacle or a connection to the vehicle battery.

Follow the steps mentioned below to connect OBD II vehicle:

1. Locate vehicle's DLC socket.
2. Plug the VCI device into the vehicle's DLC socket (It is suggested to use the OBD II extension cable to connect the VCI device and DLC socket).

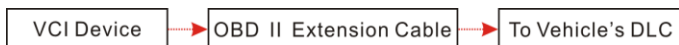

3. Choose one of the two ways to obtain power from:
 - A. Power adaptor: Connect one end of the included power adaptor to charging port of the tablet, and the other end to AC outlet.
 - B. Internal battery pack

For non-OBDII vehicle, proceed as follows:

1. Locate vehicle's DLC socket.
2. Select the corresponding non-16pin connector.

3. Plug the non-16pin end of the connector into the DLC socket, then connect the other end to the OBD I adaptor, and then tighten the captive screws.
4. Connect the other end of the adaptor to the included VCI device.
5. If the pin of the DLC is damaged or has insufficient power, please follow the either of the following methods to proceed:

A. Cigarette Lighter cable (optional): Connect one end of the cigarette lighter cable to vehicle's cigarette lighter receptacle, and the other end to the power jack of OBD I adaptor.

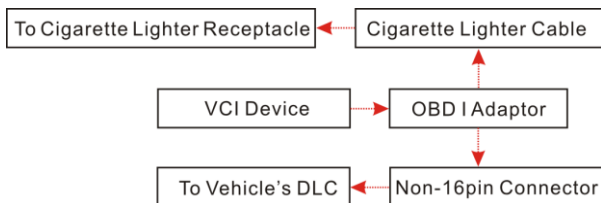

B. Battery Clamps Cable: Connect one end of the battery clamps cable to vehicle's battery, and the other end to the power jack of OBD I adaptor.

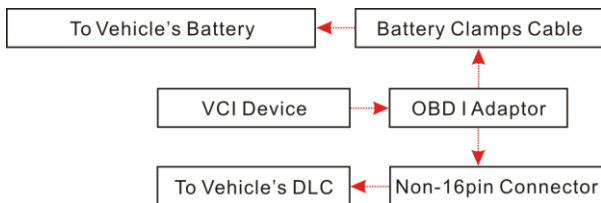

Vehicle connection (For Commercial Vehicle Configuration):

The method used to connect the VCI module to a vehicle's DLC depends on the vehicle's configuration as follows:

A. OBD II Vehicle Connection: Plug one end of the diagnostic cable into the vehicle's DLC, and the other end into the diagnostic socket of the VCI module, and then tighten the captive screws.



B. Non-OBD II Vehicle Connection: For vehicles with non-OBD II diagnostic socket, a non-16pin connector (adaptor cable) is required.

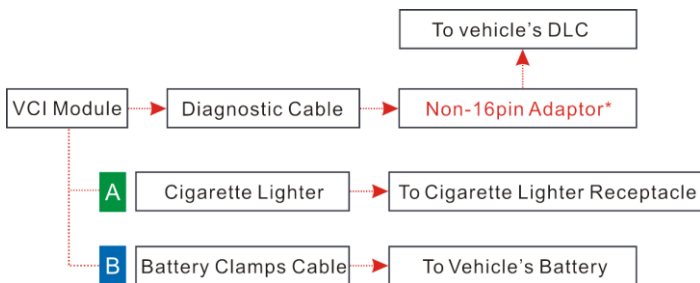

5 Diagnosis

5.1 Intelligent Diagnose

Through simple Bluetooth communication between the display tablet and the VCI, you can easily get the VIN (Vehicle Identification Number) information of the currently identified vehicle. Once the VIN is successfully identified, the system will retrieve it from the remote server and then guide you to vehicle information page without the necessity of step-by-step manual menu selection.

The vehicle information page lists all historical diagnostic records of the vehicle, which lets the technician have a total command of the vehicle faults. In addition, a quick dial to local diagnose and diagnostic function are also available on this page for reducing the roundabout time and increasing productivity.

 Note:

- Before using this function, please make sure the VCI is properly connected to the vehicle's DLC. For detailed connection, see Chapter 4.3.3 **Vehicle Connection**.
- A stable network connection is required for this function.

Follow the steps below to proceed.

1. Tap **Intelligent Diagnose** on the Job menu screen.

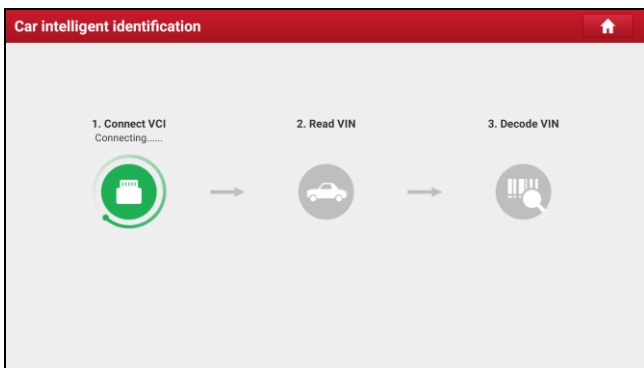

 Note: If the VCI is not paired up with the tablet before doing this step, a prompt message box will appear on the screen. Check all the possible reasons of Bluetooth connection failure carefully, and then tap **OK** to the following screen.

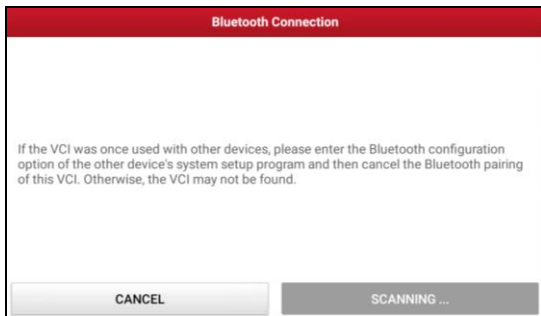

If the VCI was once used with other devices, you need to cancel the pairing of the VCI first via either one of the following ways:

- On the Android's home screen, tap **Settings** -> **Bluetooth** -> Choose the desired VCI from the Paired list. Tap , and then tap **FORGET** to unpair it.
- Tap **User Info** -> **VCI Management** -> Tap **Deactivate matching**.

Tap **Scan** to start searching for the VCI and pairing up with it.

2. Once pairing is complete, the handset starts reading the vehicle VIN.

A. If the VIN can be found from the remote server database, the following screen will appear:

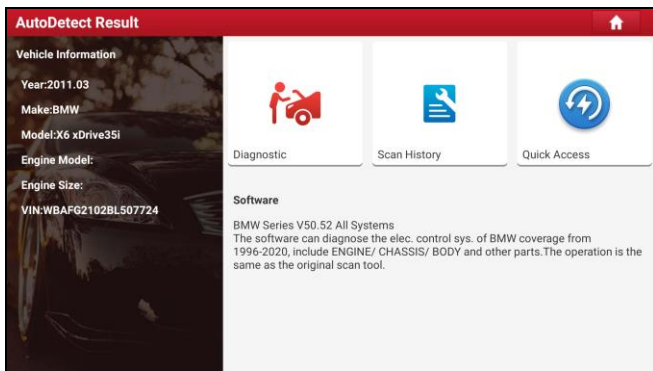

- Tap **Diagnostic** to start a new diagnostic session.
- To perform other functions, tap **Quick access** to directly go to the diagnostic

function selection screen. Choose the desired one to start a new diagnostic session.

- Tap **Scan History** to view its historical repair record. If there are records available, it will be listed on the screen in sequence of date. If no records exist, the screen will show “No Record.”

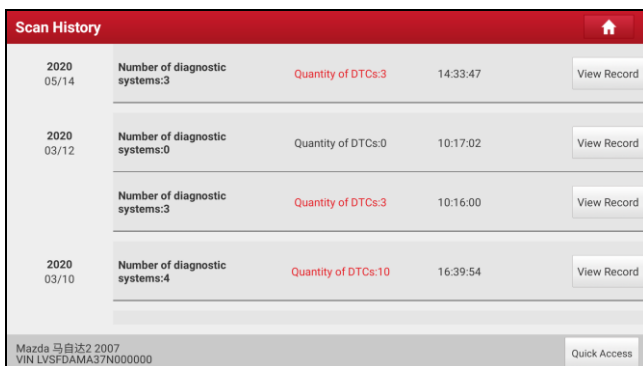

- Tap **View record** to view the details of the current diagnostic report.
 - To perform other functions, tap **Quick access** to directly go to the diagnostic function selection screen. Choose the desired one to start a new diagnostic session.
- B. If the handset failed to access the VIN information, the screen will display as below:

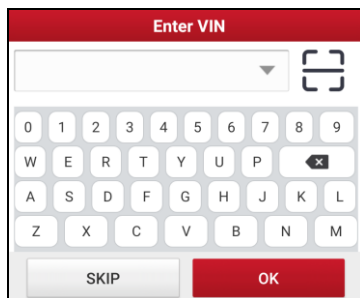





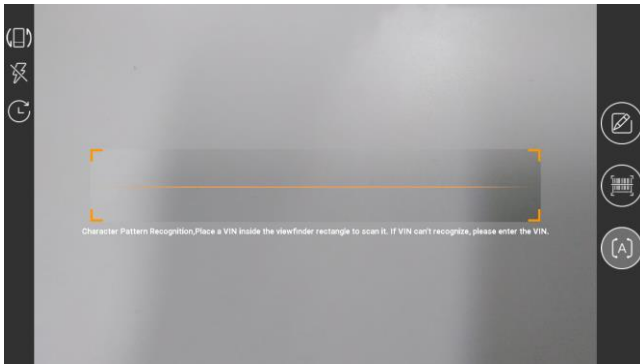

- Tap the input field to directly, tap **OK**. If the VIN exists on the remote server, the system will enter the diagnostic function selection screen.

- Tap  to launch the VIN recognition module.



Place the VIN inside the viewfinder rectangle to scan it. The most recognizable location for this number is in the top left corner on the vehicle's dashboard. Other locations include the driver's door or post, and the firewall under the hood.

- Tap  to switch the display mode of the screen.
- Tap  to turn the camera flash on.
- Tap  to choose it from the record list if the VIN of the vehicle has been scanned before.
- Tap  to input the VIN manually if the tablet has failed to identify the VIN of the vehicle.
- Tap  to scan the VIN barcode. If the VIN barcode cannot be recognized, please manually input the VIN.
- Tap  to scan the VIN character. If the VIN character cannot be recognized, please manually input the VIN.

 Note: In general, vehicle identification numbers are standardized - all contain 17 characters. VIN characters may be capital letters A through Z and numbers 1 through 0; however, the letters I, O and Q are never used in order to avoid mistakes of misreading. No signs or spaces are allowed in the VIN.

After scanning, the screen automatically displays the result.

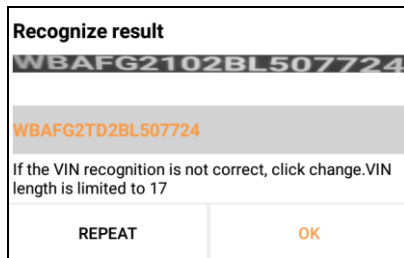

- If the VIN scanned is incorrect, tap the result field to modify it and then tap **OK**.
- To scan it again, tap **REPEAT**.

If the VIN exists on the remote server, the system will enter the diagnostic function selection screen.

5.2 Local Diagnose

In this mode, you need to execute the menu-driven command and then follow the on-screen instruction to proceed.

Tap **Local Diagnose** to enter the vehicle selection page.

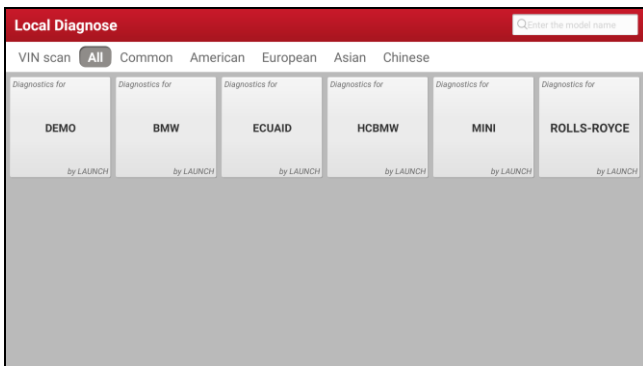

Two approaches are provided for you to access the vehicle diagnostic software. Choose any one of the following ways:

1. VINSKAN enables you to access it more quickly.

Tap **VINScan**, the screen displays as follows:

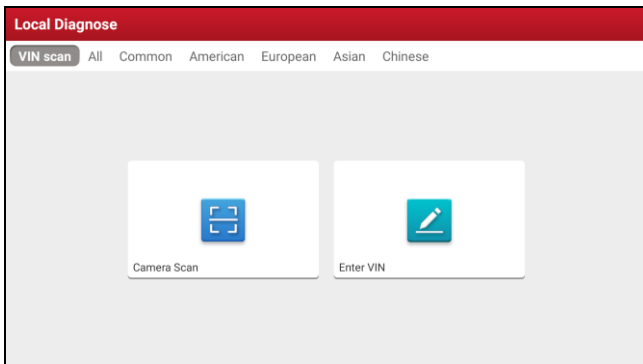

In this case, camera scan and enter VIN are available.



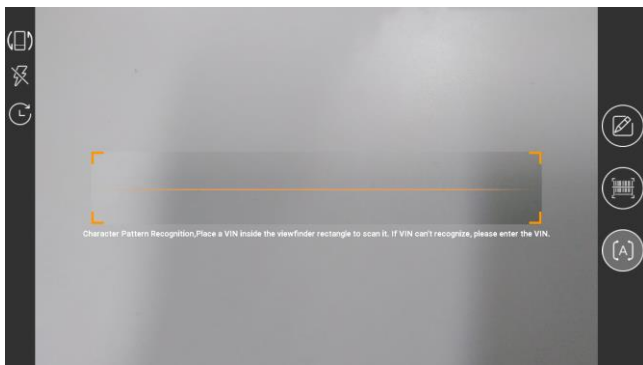

A. Camera Scan: In this mode, the VCI should be connected to the vehicle's DLC first, and then a Bluetooth communication should be established between the tablet and the VCI.

Tap **Camera Scan**, a screen similar to the following appears:



Place the VIN inside the viewfinder rectangle to scan it. The most recognizable location for this number is in the top left corner on the vehicle's dashboard. Other locations include the driver's door or post, and the firewall under the hood.

- Tap  to switch the display mode of the screen.

- Tap  to turn the camera flash on.
- Tap  to choose it from the record list if the VIN of the vehicle has been scanned before.
- Tap  to input the VIN manually if the tablet has failed to identify the VIN of the vehicle.
- Tap  to scan the VIN barcode. If the VIN barcode cannot be recognized, please manually input the VIN.
- Tap  to scan the VIN character. If the VIN character cannot be recognized, please manually input the VIN.

 Note: In general, vehicle identification numbers are standardized - all contain 17 characters. VIN characters may be capital letters A through Z and numbers 1 through 0; however, the letters I, O and Q are never used in order to avoid mistakes of misreading. No signs or spaces are allowed in the VIN.

After scanning, the following screen will appear.

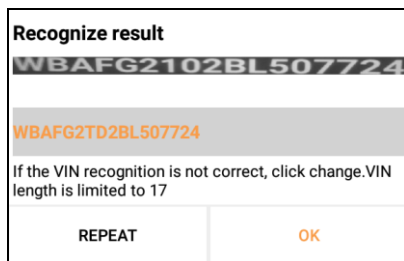

If the VIN scanned is incorrect, tap the result field to modify it and then tap **OK**. If the VIN exists on the remote server, the system will navigate to the diagnostic function selection screen directly.

Tap the desired option to perform the corresponding diagnostic function.

 Note: Before using this function, the corresponding diagnostic software and Auto search file need to be downloaded on your tool first while downloading the diagnostic software.

B. INPUT VIN: In this mode, you can input the vehicle VIN manually. In general, the vehicle identification numbers are standardized - all contain 17

characters. VIN characters may be capital letters A through Z and numbers 1 through 0; however, the letters I, O and Q are never used in order to avoid mistakes of misreading. No signs or spaces are allowed in the VIN.

Tap **Enter VIN**, the following screen will appear.

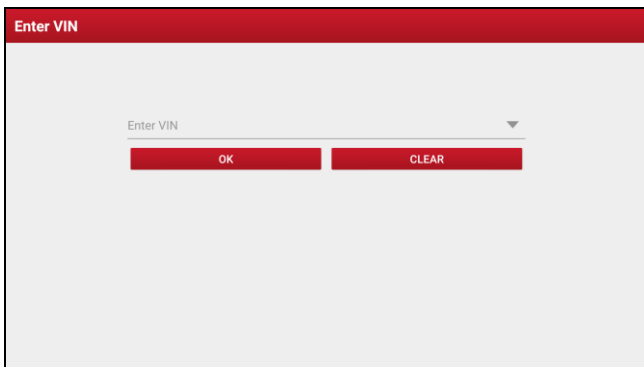

Input the VIN, and tap **OK**, the tablet will automatically identify the vehicle model and directly navigate to the diagnostic function selection menu.

2. Tap a corresponding diagnostic software logo, and then follow the on-screen instruction to access the diagnostic software.

Take Demo as an example to demonstrate how to diagnose a vehicle.

- 1). Select diagnostic software version: Tap the **DEMO** to go to Step 2. (🚫 Note: If more than one version is available on this handset, it will be listed on the screen.)

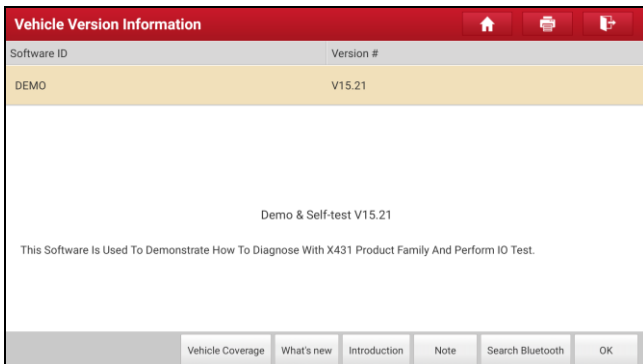

On-screen Buttons:

Vehicle Coverage: Tap to view the vehicle models that the current diagnostic software covers.

What's new: Tap to view the optimized items and enhancements.

Introduction: Tap to check the software function list.

Note: Tap to read some precautions on using the current diagnostic software.

Search Bluetooth: Tap to search for the available VCI. After the VCI is successfully activated, it will be bound to the user account and paired with the tablet automatically.

 Note: No Bluetooth connection is required for DEMO program.

OK: Tap it to go to next step.

2). **Select vehicle model (varies with different versions):** Select the desired vehicle model. Here we take **Ford** for example to demonstrate how to diagnose a vehicle.

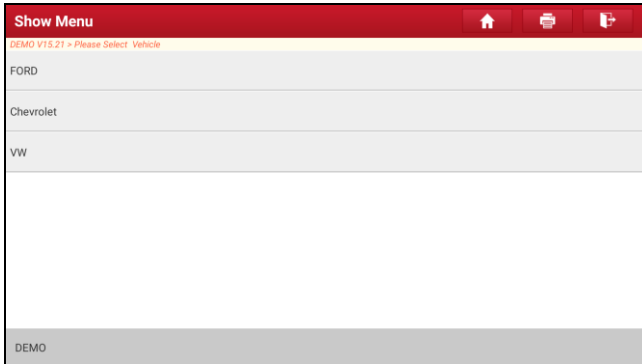

- 3). Read vehicle information: After reading the vehicle information, double check if the vehicle information is correct or not. If yes, tap **Yes** to continue.

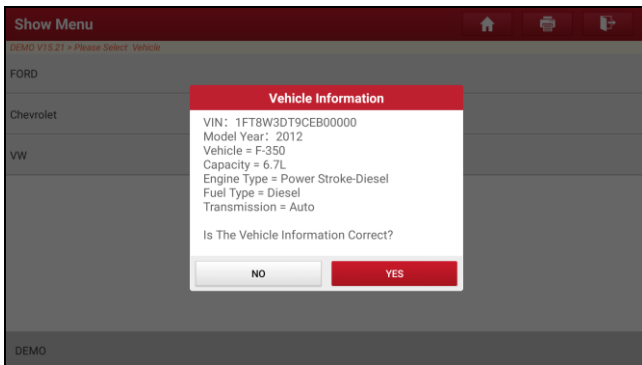

- 4). Select test item: Select the desired test item to proceed.



5). Turn the ignition key to ON: Set the ignition switch to on.

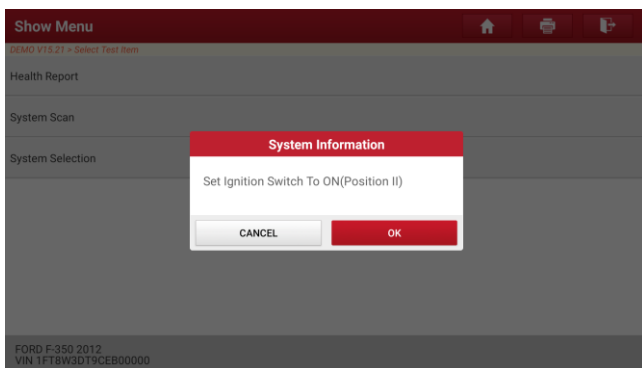

5.2.1 Health Report (Quick Test)

This function varies from vehicle to vehicle. It enables you to quickly access all the electronic control units of the vehicle and generate a detailed report about vehicle health.

On the test item selection screen, tap **Health Report** and turn on the ignition switch, the system will start scanning the ECUs. Once the scanning process is complete, the following screen will appear:

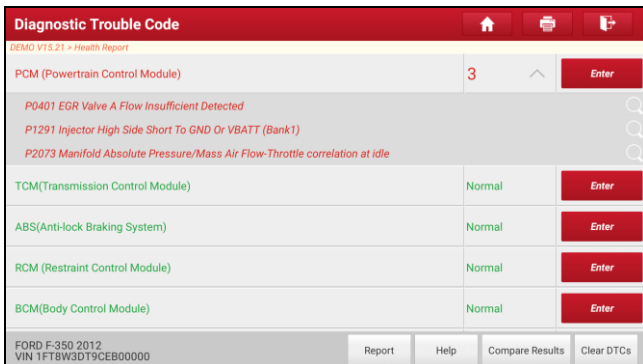

The tested system with fault code appears in red and the system with OK displays in black (normally).

 Note: Diagnostic Trouble Codes or Fault Codes can be used to identify which engine systems or components that are malfunctioning. Never replace a part based only on the DTC definition. Retrieving and using DTCs for troubleshooting vehicle operation is only one part of an overall diagnostic strategy. Follow testing procedures (in vehicle's service manual), instructions and flowcharts to confirm the locations of the problem.

On-screen Buttons:

Enter: Tap to enter the diagnostic function selection screen.

 **(Search):** Highlight certain diagnostic trouble code and tap it to retrieve it in the search engine.

Report: Tap to save the diagnostic result as a health report.

Report Information

Report Type

Pre-Repair ▼

Vehicle Information

FORD	F-350 ✕
2012 ✕	35565 km ✕
1FT8W3DT9CEB00000	License #:

Report Info

FORD_1FT8W3DT9CEB00000_AllSystemDTC_20200514154114 ✕

Notes:

SKIP OK

 Note: Diagnostic report is classified into three categories: Pre-Repair report, Post-Repair report and Diagnostic Scan. No matter which type you saved the report as, the report type will be appended as a tag on the upper right corner of the diagnostic report for easier identification.

Tap ▼ to select the report type from the option list and input the required information, and then tap **OK**.

 Note: To facilitate the comparison of the pre-repair and post-repair reports and get accurate test result, please make sure you saved the right type of the diagnostic report.

To save the report as a common diagnostic report, select **Diagnostic Scan**.

More Information

Shop Name Launch HQ	Telephone 18123979575	
Address line1 Long gang District	Email 764080333@qq.com	
Address line2	Technician Name	Add
City shenzhen	Customer Name Customer Name	
State Guangdong Province	Zip Code 518129	Country Afghanistan
SKIP		OK

 Note: For workshop information, tap the input box to enter it. Alternatively you can also set it in **User Info -> Settings -> Shop Information**.

Once you configured the information, it will be automatically generated every time you saved the diagnostic report. All vehicle and workshop information will be appended as tags on the diagnostic report.

To ignore the workshop information, tap **Skip** to go to the report details screen.

Report

431
Pre-Repair

Vehicle Diagnostic Report

The Report is created by **LAUNCH X431**

Repair Shop

Shop Name: Launch HQ
 Address: Long gang District shenzhen Guangdong Province
 Zip Code: 518129
 Telephone: 18123979575
 Email: 764080333@qq.com
 Fax: fax
 SN: 989340000112
 Test Time: 2020-05-14 15:50:03



FORD F-350 2012
VIN 1FT8W3D19CEB00000

Share
Save

On the report details screen, tap **Save** to save it. All diagnostic reports are saved in **User Info -> My Report -> Health Report**.

Help: Tap to view the help information of the selected DTC item.

Compare Results: Tap to select the pre-repair report to compare. By

comparison of the pre- and post- repair reports, you can easily identify which DTCs are cleared and which remain unfixed.

Compare Results		
DCMO V15.21 > Health Report		
DTC	Post	Pre
PCM (Powertrain Control Module)		
P0401 EGR Valve A Flow Insufficient Detected	Cleared	Found
P1291 Injector High Side Short To GND Or VBATT (Bank1)	Cleared	Found
P2073 Manifold Absolute Pressure/Mass Air Flow-Throttle correlation at idle	Cleared	Found

- **Post** indicates DTC status of post-repair.
- **Pre** indicates DTC status of pre-repair.

 Note: Before performing this function, make sure you have met the following conditions:

- You have saved a pre-repair report of the currently tested vehicle, and
- You have already made some repairs and service and cleared the DTCs after the pre-repair reported is generated. Otherwise, no differences exist between the pre- and post- repair reports.

Clear DTCs: Tap to clear the existing diagnostic trouble codes.

 Note: Clearing DTCs does not fix the problem(s) that caused the code(s) to be set. If proper repairs to correct the problem that caused the code(s) to be set are not made, the code(s) will appear again and the check engine light will illuminate as soon as the problem that cause the DTC to set manifests itself.

5.2.2 System Scan

This option allows you to quickly scan which systems are installed on the vehicle.

On the test item selection screen, tap **System Scan**, the system start scanning the systems. Once the scanning process is complete, the following screen will appear.

Select Test Item	
DEMO V15.21 > System Scan	
System Name	Result
PCM (Powertrain Control Module)	Equipped
TCM(Transmission Control Module)	Equipped
ABS(Anti-lock Braking System)	Equipped
RCM (Restraint Control Module)	Equipped
BCM(Body Control Module)	Equipped
IMMO(Immobilizer)	Equipped
APIM (Accessory Protocol Interface Module)	Equipped
PAM (Parking Assist Module)	Equipped
FORD F-350 2012 VIN 1FT8W3D19CEB00000	

Tap the desired system to go to the diagnostic function selection screen. For detailed operations on diagnostic function, please refer to Chapter 5.2.3.

5.2.3 System Selection

This option allows you to manually select the test system and function step by step.

On the test item selection screen, tap **System Selection**, the screen displays as follows:

Show Menu	
DEMO V15.21 > System Selection	
PCM (Powertrain Control Module)	TCM(Transmission Control Module)
ABS(Anti-lock Braking System)	RCM (Restraint Control Module)
BCM(Body Control Module)	IMMO(Immobilizer)
APIM (Accessory Protocol Interface Module)	PAM (Parking Assist Module)
ICM1 (Information Center Module)	DDM (Driver Door Module)
DSM (Driver Seat Module)	DSP (Digital Signal Processor)
IPC (Instrument Panel Control Module)	FCIM (Front Controls Interface Module)
FORD F-350 2012 VIN 1FT8W3D19CEB00000	

Swipe the screen from the bottom to view the vehicle system on the next page.

Tap the target system (take **PCM** for example) to navigate to the diagnostic function selection screen.

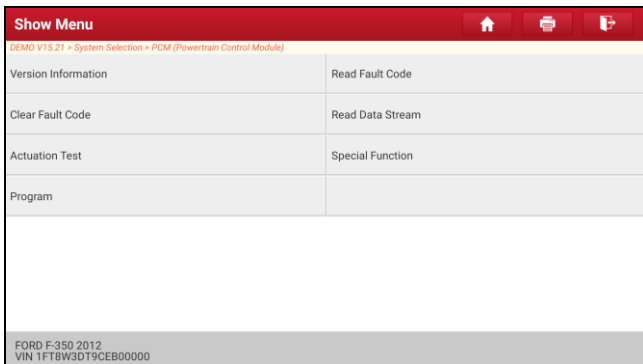

 Note: Different vehicle has different diagnostic menus.

A. Version Information

This function is used to read the version information of system mode, vehicle VIN, software and ECU.

B. Read Fault Code

This function displays the detailed information of DTC records retrieved from the vehicle's control system.

 Note: Retrieving and using DTCs for troubleshooting vehicle operation is only one part of an overall diagnostic strategy. Never replace a part based only on the DTC definition. Each DTC has a set of testing procedures, instructions and flow charts that must be followed to confirm the location of the problem. This information can be found in the vehicle's service manual.

On the diagnostic function selection screen, tap **Read Fault Code**, the screen will display the diagnostic result.

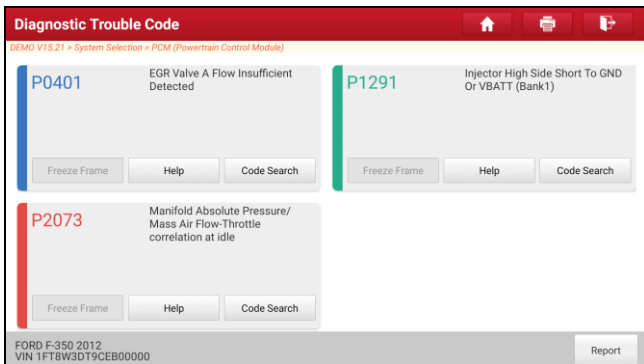

On-screen Buttons:

Freeze Frame: When an emission-related fault occurs, certain vehicle conditions are recorded by the on-board computer. This information is referred to as freeze frame data. Freeze frame data includes a snapshot of critical parameter values at the time the DTC is set.

Help: Tap to view the help information.

Code Search: Tap to search for more information about the current DTC online.

Report: Tap to save the current data in text format. All reports are saved in **User Info -> My Report -> Health Reports**. For details on report operations, please refer to Chapter 9.1 **My Report**.

C. Clear Fault Code

This function enables you to erase the codes from the vehicle after reading the retrieved codes from the vehicle and certain repairs have been carried out. Before performing this function, make sure the vehicle's ignition key is in the ON position with the engine off.

Clearing DTCs does not fix the problem(s) that caused the code(s) to be set. If proper repairs to correct the problem that caused the code(s) to be set are not made, the code(s) will appear again and the check engine light will illuminate as soon as the problem that cause the DTC to set manifests itself.

On the diagnostic function screen, tap **Clear Fault Code**, the following screen will appear.

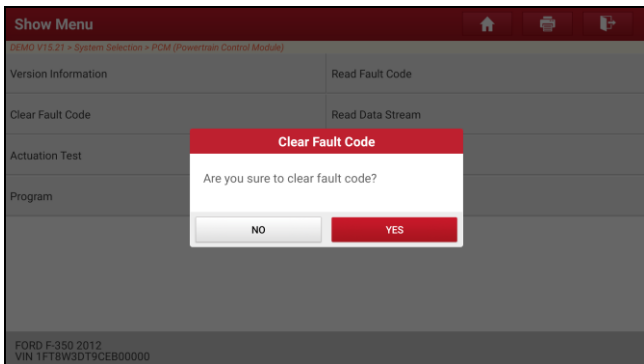

Tap **YES**, the system will automatically delete the currently existing trouble code.

 Note: After clearing, you should retrieve trouble codes once more or turn ignition on and retrieve codes again. If there are still some trouble codes in the system, please troubleshoot the code using a factory diagnosis guide, then clear the code and recheck.

D. Read Data Stream

This option lets you view and capture (record) real-time Live Data. This data including current operating status for parameters and/or sensor information can provide insight on overall vehicle performance. It can also be used to guide vehicle repair.

 Note:

- If you must drive the vehicle in order to perform a troubleshooting procedure, **ALWAYS** have a second person help you. Trying to drive and operate the diagnostic tool at the same time is dangerous, and could cause a serious traffic accident.
- The real time (Live Data) vehicle operating information (values/status) that the on-board computer supplies to the tool for each sensor, actuator, switch, etc. is called Parameter Identification Data (PID).

On the diagnostic function selection screen, tap **Read Data Stream**, the following screen will appear.

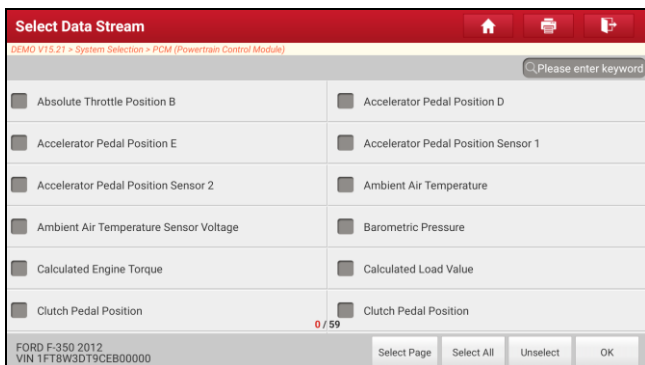

On-screen Buttons:

Select Page: Tap to select all items of the current page.

Select All: Tap to select all items. To select certain data stream item, just check the box before the item name.

Unselect: Tap to deselect all data stream items.

OK: Tap to confirm and jump to the next step.

After selecting the desired items, tap **OK** to enter the data stream reading page.

Name	Value	Standard Range	English	Metric
Absolute Throttle Position B	14.12	0 - 100	%	
Accelerator Pedal Position D	7.06	0 - 100	%	
Accelerator Pedal Position E	24.71	0 - 100	%	
Accelerator Pedal Position Sensor 1	1.04	0 - 5	V	
Accelerator Pedal Position Sensor 2	0.53	0 - 5	V	
Ambient Air Temperature	21 (1 / 2)	-40 - 215	degree C	

Note:

- If the value of the data stream item is out of the range of the standard (reference) value, the whole line will display in red. If it complies with the reference value, it

displays in blue (normal mode).

- The indicator 1/X shown on the bottom of the screen stands for the current page/total page number. Swipe the screen from the right/left to advance/return to the next/previous page.

There are 3 types of display modes available for data viewing, allowing you to view various types of parameters in the most suitable way.

- ✓ **Value** – This is the default mode which displays the parameters in texts and shows in list format.
- ✓ **Graph** – Displays the parameters in waveform graphs.
- ✓ **Combine** – This option is mostly used in graph merge status for data comparison. In this case, different items are marked in different colors.

On-screen Buttons:

 **Graph(Single):** Tap to view the parameter in waveform graph.



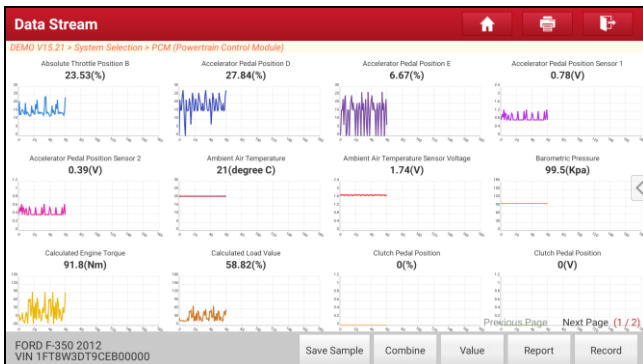

- **Min/Max:** Tap to define the maximum / minimum value. Once the value goes beyond the specified value, the system will alarm.

Graph: Tap to view the parameters in waveform graphs.

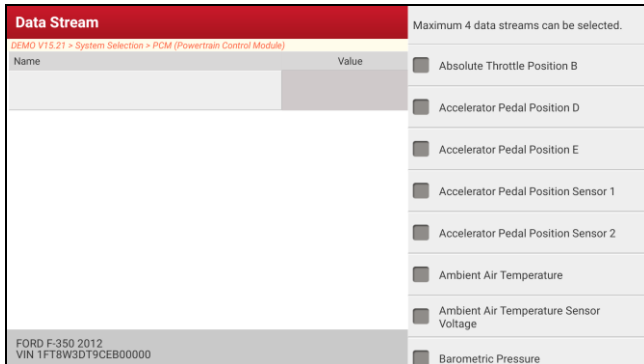

- **Combine:** This option is mostly used in graph merge status for data comparison. In this case, different items are marked in different colors (maximum 4 items can be displayed on the same screen simultaneously). If the graph is more than one page, swipe the screen from the left to jump to the next page.



- **Value:** Switches the current graph display mode to the Value display mode.
- **Customize:** Tap  key on the right, a pull-down list of the data stream items appears on the screen. Select / deselect the desired items, and then screen will display / remove the waveforms corresponding to these items immediately.

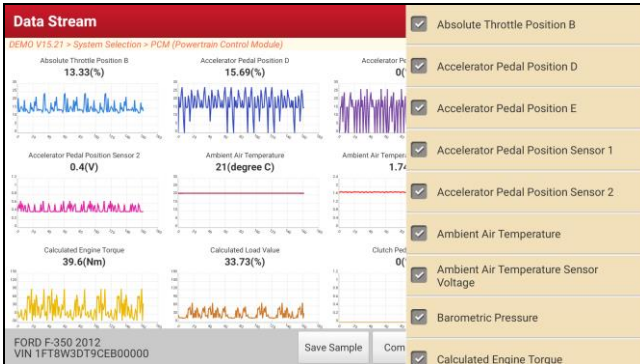

Compare Sample: Tap to select the sample DS file.

The screenshot shows the 'Data Stream' table interface. A dialog box is overlaid on the table, prompting the user to choose a sample data stream record. The table below shows the current data stream items.

Name	Value	Standard Range	English	Metric
Absolute Throttle Position B	12.55	0 - 100	%	<input checked="" type="checkbox"/>
Accelerator Pedal Position D	15.69	0 - 100	%	<input checked="" type="checkbox"/>
Accelerator Pedal Position E			%	<input checked="" type="checkbox"/>
Accelerator Pedal Position Sensor 1			V	<input checked="" type="checkbox"/>
Accelerator Pedal Position Sensor 2	0.4	0 - 5	V	<input checked="" type="checkbox"/>
Ambient Air Temperature	21 (1 / 2)	-40 - 215	degree C	<input checked="" type="checkbox"/>

All the values you customized and saved in process of DS sampling will be imported into the **Standard Range** (See below) column for your comparison.

Note: Before executing this function, you have to sample the values of data stream items and save it as a sample Data Stream file.

Data Stream						
DEMO V15.21 > System Selection > PCM (Powertrain Control Module)						
Name	Value	Standard Range (Data Stream Sample)	English	Metric		
Absolute Throttle Position B	21.96	12.55 - 15	%			
Accelerator Pedal Position D	15.69	0 - 13.6	%			
Accelerator Pedal Position E	15.69	0 - 20.4	%			
Accelerator Pedal Position Sensor 1	0.78	0.78 - 1.08	V			
Accelerator Pedal Position Sensor 2	0.4	0.39 - 0.48	V			
Ambient Air Temperature	21 (1 / 2)	21 - 21	degree C			
FORD F-350 2012 VIN 1FT8W3D19CEB00000						
Compare Sample		Save Sample	Graph	Report	Record	Help

Report: Tap to save the current data in text format. All reports are saved in **User Info -> My Report -> Health Reports**. For details on report operations, please refer to Chapter 9.1.

Record: Tap to start recording diagnostic data. Recorded live data can serve as valuable information to help you in troubleshooting of vehicle problems.

Data Stream						
DEMO V15.21 > System Selection > PCM (Powertrain Control Module)						
Name	Value	Standard Range	English	Metric		
Absolute Throttle Position B	14.51	0 - 100	%			
Accelerator Pedal Position D	20.78	0 - 100	%			
Accelerator Pedal Position E	0	0 - 100	%			
Accelerator Pedal Position Sensor 1	0.78	0 - 5	V			
Accelerator Pedal Position Sensor 2	0.4	0 - 5	V			
Ambient Air Temperature	21 (1 / 2)	-40 - 215	degree C			
FORD F-350 2012 VIN 1FT8W3D19CEB00000						
Compare Sample		Save Sample	Graph	Report	Record	Help

Tap to end recording and save it. The saved file follows the naming rule: It begins with vehicle type, and then the product S/N and ends with record starting time (To differentiate between files, please configure the accurate system time). All diagnostic records can be replayed from **User Info -> My Report -> Recorded Data**.

Save Sample: This item enables you to customize the standard range of live

data stream items and save it as DS sample file. Each time you run the data stream items, you can call out the corresponding sample data to overwrite the current standard range.

Tap it to start recording the sample data ( Note: Only data stream items with measurement units will be recorded), the following screen will appear:

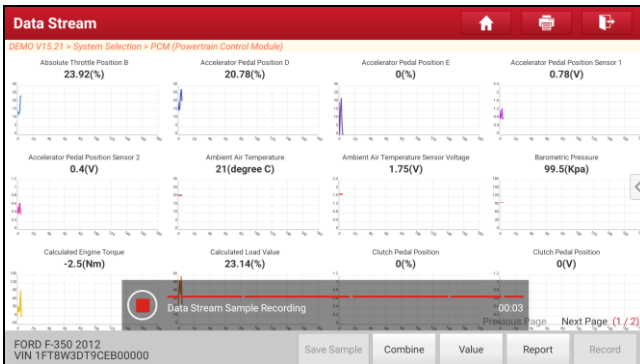

Once the recording process is complete, tap  to stop it and navigate to the data revision screen.

The screenshot shows the 'Confirm Sample DS' screen with a red header. Below the header, there is a table with the following data:

Name	Min Value	Max Value	Unit
Absolute Throttle Position B	12.55	23.92	%
Accelerator Pedal Position D	0.0	27.84	%
Accelerator Pedal Position E	0.0	26.67	%
Accelerator Pedal Position Sensor 1	0.78	1.28	V
Accelerator Pedal Position Sensor 2	0.39	0.65	V
Ambient Air Temperature	21.0	21.0	degree C

At the bottom left, the vehicle information 'FORD F-350 2012 VIN 1FT8W3DT9CEB00000' is visible. A 'Save' button is located at the bottom right.

Tap the Min./Max. value to change it. After modifying all desired items, tap **Save** to save it as a sample DS file. All DS files are stored in **User Info -> Data Stream Sample**.

E. Actuation Test

This option is used to access vehicle-specific subsystem and component tests. Available test vary by vehicle manufacturer, year, and model.

During the actuation test, the display tablet outputs commands to the ECU in order to drive the actuators, and then determines the integrity of the system or parts by reading the ECU data, or by monitoring the operation of the actuators, such as switching an injector between two operating states.

On the diagnostic function selection screen, tap **Actuation Test**, the system will display as follows:

Show Menu	
DEMO V15.21 > System Selection > PCM (Powertrain Control Module)	
Air Conditioning Compressor Commanded State	Service Tool Fuel Multiplier For Cylinder 1
Service Tool Fuel Multiplier For Cylinder 2	Service Tool Fuel Multiplier For Cylinder 3
Service Tool Fuel Multiplier For Cylinder 4	Service Tool Fuel Multiplier For Cylinder 5
Service Tool Fuel Multiplier For Cylinder 6	Service Tool Fuel Multiplier For Cylinder 7
Service Tool Fuel Multiplier For Cylinder 8	Commanded Exhaust Gas Recirculation a Duty Cycle or Position
Commanded Fuel Rail Pressure A	Desired Idle Speed RPM
EGR(Exhaust Gas Recirculation) Cooler Bypass Valve	Exhaust Gas Recirculation Throttle Position Commanded
FORD F-350 2012 VIN 1FT8W3DT9CEB00000	

Simply follow the on-screen instructions and make appropriate selections to complete the test.

Actuation Test	
DEMO V15.21 > System Selection > PCM (Powertrain Control Module)	
Select Test Item	Result
Air Conditioning Compressor Commanded State	
<div style="display: flex; justify-content: space-around; margin-top: 20px;"> Monitor On Off </div>	
FORD F-350 2012 VIN 1FT8W3DT9CEB00000	

Each time when an operation is successfully executed, "Completed" displays.

F. Special Function

In addition to amazing & powerful diagnostic function, the tool also features various reset functions, which varies from vehicle to vehicle.

5.3 Remote Diagnose

This option aims to help repair shops or technicians launch instant messaging and remote diagnosis, making the repair job getting fixed faster.

Tap “Remote Diagnose” on the Job menu, the screen appears blank by default.

5.3.1 Interface Layout

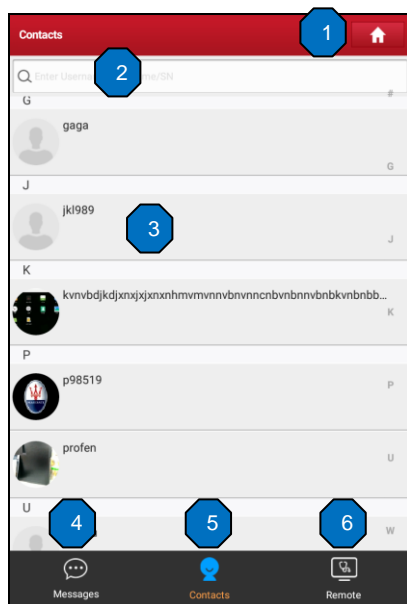

1	Home button	Tap it to navigate to the Job menu screen.
2	Search bar	Directly input the registered username of the tool to start searching, and then tap the desired one to add it into your friend list.
3	Friend list display area	By default it appears blank.
4	Message tab	Once an incoming message reaches, a red dot will appear on the upper right corner of the tab.

5	Contact tab	Tap to enter the friend list.
6	Remote switch	Tap to slide the switch to ON, the tool keeps online and becomes accessible on the web client. In this case, inform the technician of your product S/N, and he/she will control your device remotely.

5.3.2 Add Friends

Tap **Contact** to enter the contact page. By default it appears blank.

In the search bar, input the partner's username and tap **Search** button next to the search bar to start searching from Launch's golo business database.

The partner must be the users who have registered their Launch's diagnostic tools. They may be the following:

- Workshop
- Technician
- golo users

Once the result matches the keyword, the following screen will appear:

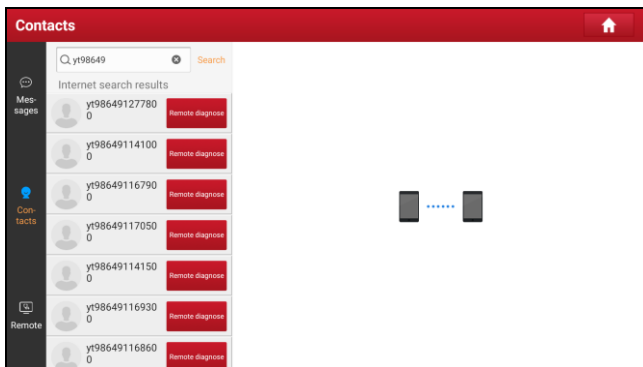

Tap **Remote Diagnose** to launch remote diagnostics directly or follow the steps below to add the partner into the Contacts list.

Tap the desired name from the list, the following screen appears:

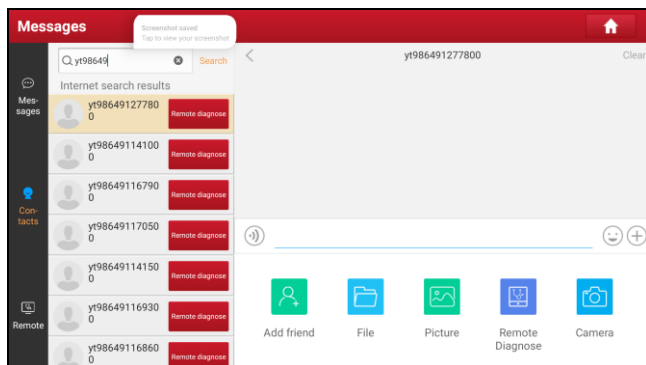

Tap **Add friend**, a dialog box pops up:

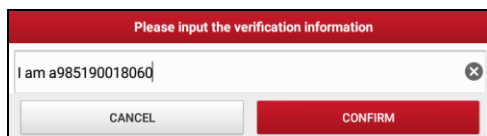

Tap **CONFIRM** to send your request.

Once the partner receives the request, a beep will sound. Tap the **Message** tab:

- Once the partner agreed your request, he/she will automatically be listed in the Contact tab.
- If a technician sent you a friend request, tap **Agree** and his/her name will appear in the friend list (Contact). Or tap **Ignore** to ignore this request.

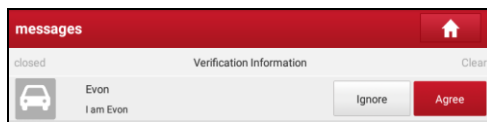

5.3.3 Start Instant Messaging

 Note: The I/M (Instant Messaging) function is open to all users who had Launch's diagnostic tool equipped with this module.

After adding your friends, tap the desired one's photo to enter a screen similar to the following figure:

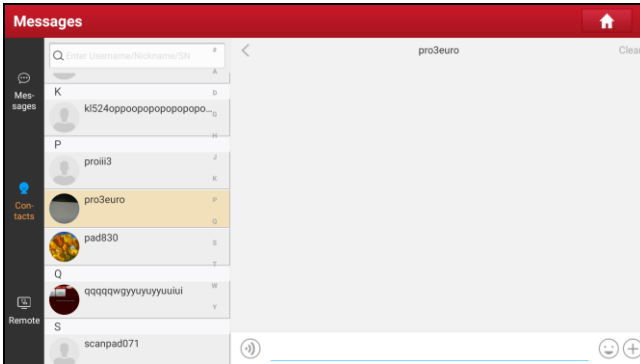

Tap the input field and use the on-screen keyboard to enter the text message, and then tap **Send** to send it.

Tap 🗣️ to send the voice message.

Tap 😊 to send the emoji.

Tap + to call out more function options.

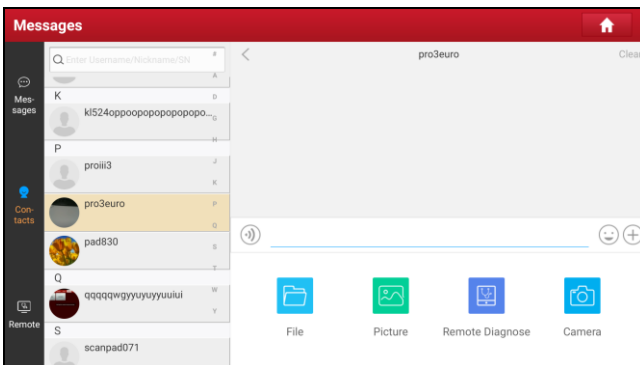

File: Choose diagnostic reports or local files to send.

Picture: Choose screenshots or pictures to send.

Remote Diagnose: To start a remote diagnostic session. For details, refer to Chapter 5.3.4.

Camera: Open camera to take pictures.

Tap **Clear** to delete all the partner's dialog logs.

Tap **Close** to close the current dialog.

5.3.4 Launch Remote Diagnosis (Device-To-Device)

The tool is allowed to initiate remote diagnosis with other diagnostic tools (including but not limited to the X-431 V+ of Launch family, which are equipped with this module).



 Note: Before performing this operation, please make sure the following no matter which side sends the remote request:

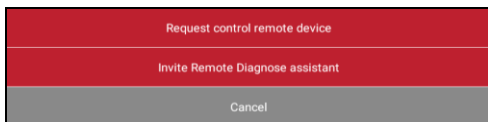

- Turn on the vehicle power supply.
- Throttle should be in a closed position.
- The tool should be properly connected to the vehicle's DLC and a successful communication is required.

On the function option selection screen, tap **Remote Diagnostic**, a pull-down menu including the following options appears:

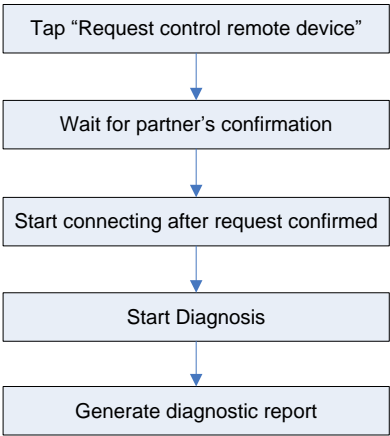

These options are defined as follows:

Actions	Results
Request control remote device	<p>Request to control the partner's device remotely to help him diagnose the vehicle.</p> <p> Note:</p> <ul style="list-style-type: none"> • Remote diagnosis has the same diagnostic steps as manual diagnosis. • In process of remote diagnosis, tap the  button to send a voice message. • Once vehicle diagnosis is complete, a report will be created. Input your comments on this report, and then tap Send Report to send it to the partner.

	 <pre> graph TD A[Tap "Request control remote device"] --> B[Wait for partner's confirmation] B --> C[Start connecting after request confirmed] C --> D[Start Diagnosis] D --> E[Generate diagnostic report] </pre>
<p>Invite remote diagnostic assistant</p>	<p>If you need support, just use this option to invite a technician to perform a remote control on your tool.</p> <p> Note:</p> <ul style="list-style-type: none"> • Remote diagnosis has the same diagnostic steps as manual diagnosis. • In process of remote diagnosis, tap the  button to send voice message. • Once you received the report from the partner, tap View Report to view its details. All diagnostic reports are saved in User Info -> My Reports -> Remote Reports.

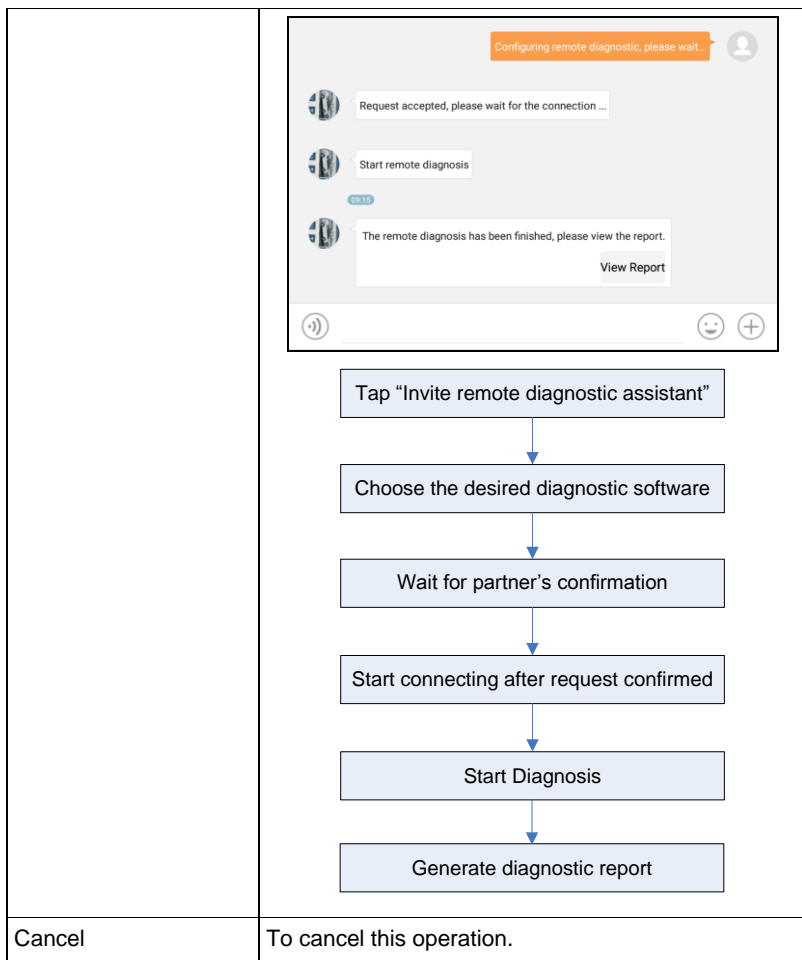

5.3.5 Launch Remote Diagnosis (Device-To-PC)

Except that the remote diagnosis can be done between different Launch's diagnostic tools that come loaded with the module, user also can ask for remote control from PC client technician.

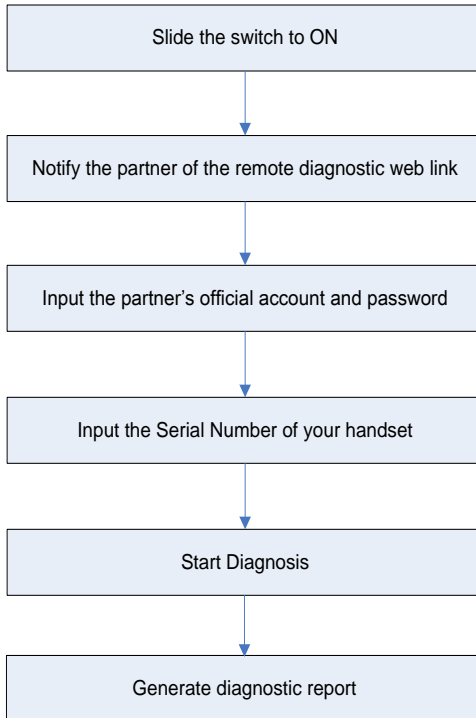

Tap the **Remote** tab, the screen displays as follows:

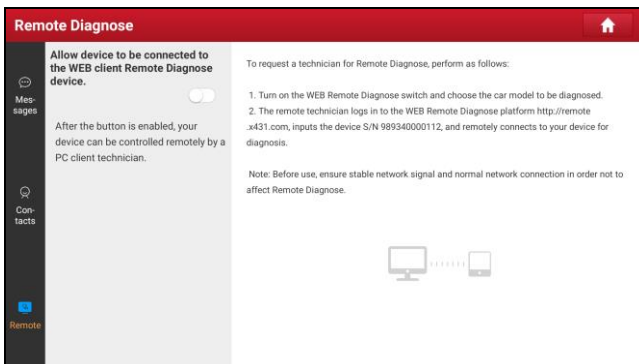

1. Slide the switch **Allow device to be connected to the WEB client remote diagnostic device** to ON so that the partner can find and connect to this device while using the PC.
2. Notify the partner of the PC client website <http://remote.x431.com>. When the partner accesses the link, the following screen will appear:

 Note: Before processing remote diagnosis, please make sure the tool is properly connected to the vehicle.

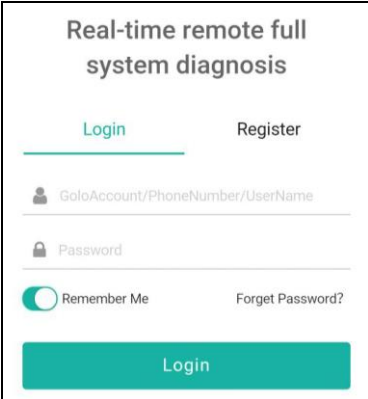

Real-time remote full
system diagnosis

Login Register

 GoloAccount/PhoneNumber/UserName

 Password

Remember Me [Forgot Password?](#)

Login

3. Tell the partner to input his own official technician account and password, and then tap **Login** to navigate to the following figure.

Remote diagnosis

Serial Number
Locate the car to be diagnosed according to golo/AIT serial number

License Plate Number
Locate the car to be diagnosed according to the car owner's license plate number

Phone Number
Locate the car to be diagnosed according to the car owner's phone number

972290000223

Start remote diagnosis

Tips: Before starting remote diagnosis, confirm the car owner's car information and condition

4. Tell the partner to check the box **Serial number** and enter the Serial Number provided by you, and then tap **Start remote diagnosis** to control your device remotely.

In process of remote diagnosis, please note the following things:

- 1) You are not suggested to execute any actions.
- 2) The partner is not allowed to save any diagnostic reports or records on your handset.

The operations in remote diagnosis are same as those in local diagnose. Once the session is complete, a remote diagnostic report will be automatically generated.

5.4 Feedback

This item allows you to feedback your diagnostic problems to us for analysis and troubleshooting.

Tap **Feedback**, a pop-up message will appear:

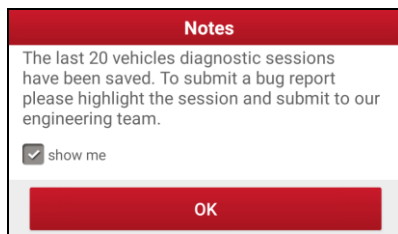

Tap **OK**, the following 3 options will be displayed on the left column of the screen.

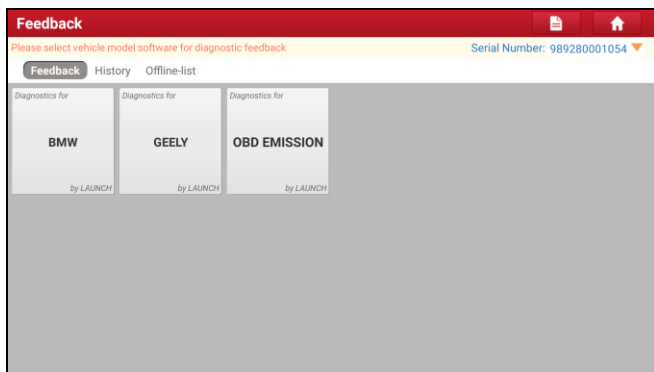

A. Feedback

Tap certain tested vehicle model to enter the feedback screen.

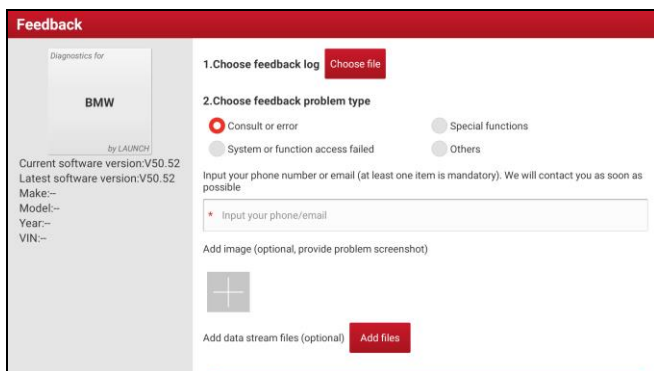

- 1) Tap **Choose File** to open the target folder and choose the desired diagnostic logs.
- 2) Choose the failure type and fill in the detailed failure description in the blank text box and telephone or email address. After inputting, tap **Submit Result** to send it to us.

B. History

Tap it to view all diagnostic feedback records. Different process states are marked with different colors.

C. Offline list

Tap it to display all diagnostic feedback logs which have not been submitted successfully due to network failure. Once the handset gets a stable network signal, it will be uploaded to the remote server automatically.

5.5 Diagnostic History

Generally once a vehicle diagnosis is performed, the tool will record the every details of diagnostic process. The History function provides direct access to the previously tested vehicles and users can resume from the last operation, without starting from scratch.

Tap **Diagnostic History** on the Job menu screen, all diagnostic records will be listed on the screen in date sequence.

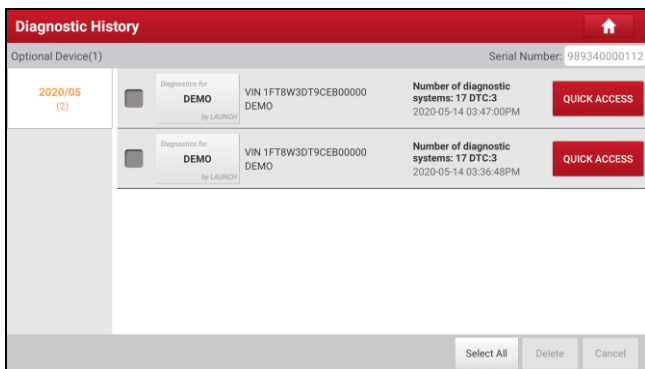

- Tap certain vehicle model to view the details of the last diagnostic report.

- To delete certain diagnostic history, select it and then tap **Delete**. To delete all historical records, tap **Select All** and then tap **Delete**.
- Tap **Quick Access** to directly navigate to the function selection page of last diagnostic operation. Choose the desired option to proceed.

6 Special (Reset) Function

Except that the special functions can be performed from the diagnostic menus (See Chapter 5.2.3) of certain vehicle model, this module provides an easy dial to quickly access the special functions.

The most commonly performed service functions contain:

- Oil Reset Service
- Electronic Parking Brake Reset
- Steering Angle Calibration
- ABS Bleeding
- TPMS (Tire Pressure Monitor System) Reset
- Gear Learning
- IMMO Service
- Injector Coding
- Battery Maintenance System
- Diesel Particulate Filter (DPF) Regeneration
- Electronic Throttle Position Reset
- Gearbox Matching
- AFS (Adaptive Front-lighting System) Reset
- Sunroof Initialization
- Suspension Calibration

There are two methods to reset service lamp: Manual reset or Auto reset. Auto reset follows the principle of sending command from the tool to vehicle's ECU to do resetting. While using manual reset, users just follow the on-screen instructions to select appropriate execution options, enter correct data or values, and perform necessary actions, the system will guide you through the complete performance for various service operations.

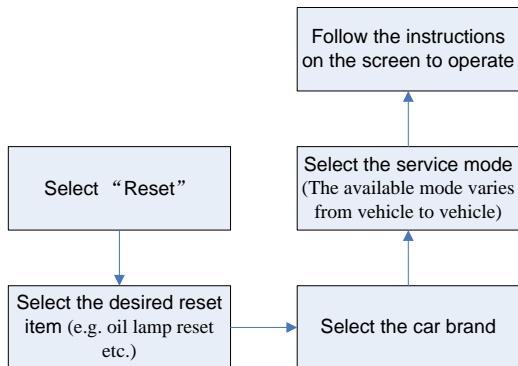

6.1 Oil Reset Service

This function allows you to perform reset for the engine oil life system, which calculates an optimal oil life change interval depending on the vehicle driving conditions and climate.

This function can be performed in the following cases:

1. If the service lamp is on, you must provide service for the car. After service, you need to reset the driving mileage or driving time so that the service lamp turns off and the system enables the new service cycle.
2. After changing engine oil or electric appliances that monitor oil life, you need to reset the service lamp.

6.2 Electronic Parking Brake Reset

1. If the brake pad wears the brake pad sense line, the brake pad sense line sends a signal sense line to the on-board computer to replace the brake pad. After replacing the brake pad, you must reset the brake pad. Otherwise, the car alarms.
2. Reset must be performed in the following cases:
 - a) The brake pad and brake pad wear sensor are replaced.
 - b) The brake pad indicator lamp is on.
 - c) The brake pad sensor circuit is short, which is recovered.
 - d) The servo motor is replaced.

6.3 Steering Angle Calibration

To reset the steering angle, first find the relative zero point position for the car to drive in straight line. Taking this position as reference, the ECU can calculate the accurate angle for left and right steering.

After replacing the steering angle position sensor, replacing steering mechanical parts (such as steering gearbox, steering column, end tie rod, steering knuckle), performing four-wheel alignment, or recovering car body, you must reset the steering angle.

6.4 ABS Bleeding

This function allows you to perform various bi-directional tests to check the operating conditions of Anti-lock Braking System (ABS).

1. When the ABS contains air, the ABS bleeding function must be performed to bleed the brake system to restore ABS brake sensitivity.
2. If the ABS computer, ABS pump, brake master cylinder, brake cylinder, brake line, or brake fluid is replaced, the ABS bleeding function must be performed to bleed the ABS.

6.5 Tire Pressure Monitor System Reset

This function allows you to quickly look up the tire sensor IDs from the vehicle's ECU, as well as to perform TPMS replacement and sensor test.

1. After the tire pressure MIL turns on and maintenance is performed, the tire pressure resetting function must be performed to reset tire pressure and turn off the tire pressure MIL.
2. Tire pressure resetting must be performed after maintenance is performed in the following cases: tire pressure is too low, tire leaks, tire pressure monitoring device is replaced or installed, tire is replaced, tire pressure sensor is damaged, and tire is replaced for the car with tire pressure monitoring function.

6.6 Gear Learning

The crankshaft position sensor learns crankshaft tooth machining tolerance and saves to the computer to more accurately diagnose engine misfires. If tooth

learning is not performed for a car equipped with Delphi engine, the MIL turns on after the engine is started. The diagnostic device detects the DTC P1336 'tooth not learned'. In this case, you must use the diagnostic device to perform tooth learning for the car. After tooth learning is successful, the MIL turns off.

After the engine ECU, crankshaft position sensor, or crankshaft flywheel is replaced, or the DTC 'tooth not learned' is present, tooth learning must be performed.

6.7 IMMO Service

An immobilizer is an anti-theft mechanism that prevents a vehicle's engine from starting unless the correct ignition key or other device is present. Most new vehicles have an immobilizer as standard equipment. An important advantage of this system is that it doesn't require the car owner to activate it since it operates automatically. An immobilizer is considered as providing much more effective anti-theft protection than an audible alarm alone.

As an anti-theft device, an immobilizer disables one of the systems needed to start a car's engine, usually the ignition or the fuel supply. This is accomplished by radio frequency identification between a transponder in the ignition key and a device called a radio frequency reader in the steering column. When the key is placed in the ignition, the transponder sends a signal with a unique identification code to the reader, which relays it to a receiver in the vehicle's computer control module. If the code is correct, the computer allows the fuel supply and ignition systems to operate and start the car. If the code is incorrect or absent, the computer disables the system, and the car will be unable to start until the correct key is placed in the ignition.

To prevent the car being used by unauthorized keys, the anti-theft key matching function must be performed so that the immobilizer control system on the car identifies and authorizes remote control keys to normally use the car.

When the ignition switch key, ignition switch, combined instrument panel, ECU, BCM, or remote control battery is replaced, anti-theft key matching must be performed.

6.8 Injector Coding

Write injector actual code or rewrite code in the ECU to the injector code of the corresponding cylinder so as to more accurately control or correct cylinder

injection quantity.

After the ECU or injector is replaced, injector code of each cylinder must be confirmed or re-coded so that the cylinder can better identify injectors to accurately control fuel injection.

6.9 Battery Maintenance System Reset

This function enables you to perform a resetting operation on the monitoring unit of vehicle battery, in which the original low battery fault information will be cleared and battery matching will be done.

Battery matching must be performed in the following cases:

- a) Main battery is replaced. Battery matching must be performed to clear original low battery information and prevent the related control module from detecting false information. If the related control module detects false information, it will invalidate some electric auxiliary functions, such as automatic start & stop function, sunroof without one-key trigger function, power window without automatic function.
- b) Battery monitoring sensor. Battery matching is performed to re-match the control module and motoring sensor to detect battery power usage more accurately, which can avoid an error message displaying on the instrument panel.

6.10 Diesel Particulate Filter (DPF) Regeneration

DPF regeneration is used to clear PM (Particulate Matter) from the DPF filter through continuous combustion oxidation mode (such as high temperature heating combustion, fuel additive or catalyst reduce PM ignition combustion) to stabilize the filter performance.

DPF regeneration may be performed in the following cases:

- a) The exhaust back pressure sensor is replaced.
- b) The PM trap is removed or replaced.
- c) The fuel additive nozzle is removed or replaced.
- d) The catalytic oxidizer is removed or replaced.
- e) The DPF regeneration MIL is on and maintenance is performed.
- f) The DPF regeneration control module is replaced.

6.11 Electronic Throttle Position Reset

This function enables you to make initial settings to throttle actuators and returns the “learned” values stored on ECU to the default state. Doing so can accurately control the actions of regulating throttle (or idle engine) to adjust the amount of air intake.

6.12 Gearbox Matching

1. This function can complete the gearbox self-learning to improve gear shifting quality.
2. When the gearbox is disassembled or repaired (after some of the car battery is powered off), it will lead to shift delay or impact problem. In this case, this function needs to be done so that the gearbox can automatically compensate according to the driving conditions so as to achieve more comfortable and better shift quality.

6.13 AFS (Adaptive Front-lighting System) Reset

This feature is used to initialize the adaptive headlamp system. According to the ambient light intensity, the adaptive headlamp system may decide whether to automatically turn on the headlamps, and timely adjust the headlamp lighting angle while monitoring the vehicle speed and body posture.

6.14 Sunroof Initialization

This function can set the sunroof lock off, closed when it rains, sliding / tilting sunroof memory function, temperature threshold outside the car etc.

6.15 Suspension Calibration

1. This function can adjust the height of the body.
2. When replacing the body height sensor in the air suspension system, or control module or when the vehicle level is incorrect, you need to perform this function to adjust the body height sensor for level calibration.

7 Software Update

This module allows you to update the diagnostic software & App and set frequently used software.

If you did not download the software in process of product registration or a pop-up message prompting you that some new software can be updated, you may use this option to download it or keep it synchronized with the latest version.

7.1 Update Diagnostic Software

Tap “Software Update” on the Home screen to enter the update center.

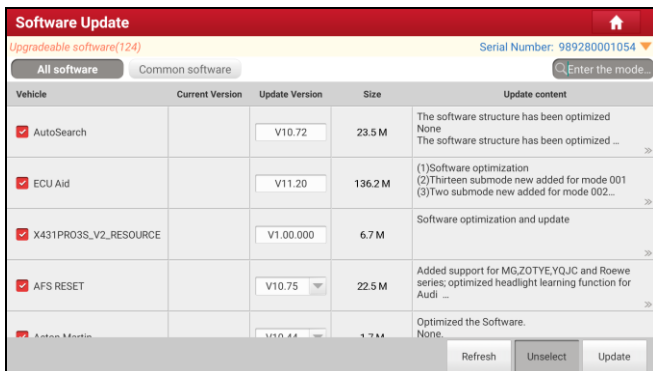

By default, all diagnostic software is selected. To deselect certain software, tap “Unselect”, and then check the box next to vehicle model. Tap “Update” to start downloading. It may take several minutes to finish it, please be patient to wait. To pause downloading, tap “Stop”. To resume it, tap “Continue”. If network connection failure occurs, tap “Retry” to try again.

Once download is finished, the software packages will be installed automatically.

7.2 Set Frequently Used software

To easily locate and quickly update some frequently used software, you can use the “Common Software” option to create a frequently used software list.

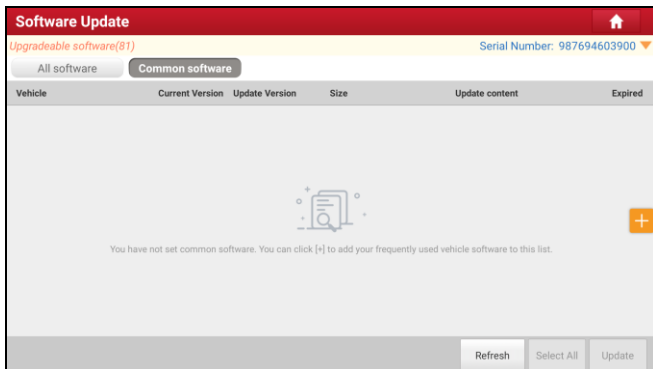

Tap “+” on the right edge of the screen, a pop-up window appears. Select the checkbox before the software name and tap “SAVE”, the software will be displayed in the Common software list. Next time you want to update it, just go to “Common Software”.

7.3 Renew Subscription

If the software subscription is due or expires, the system will prompt you to renew your subscription and a “Renew” button will appear on the bottom of the update page.

Tap “Renewal” to navigate to the payment screen.

There are two ways available for you to make payment: PayPal and Subscription Renewal Card (*need to buy it from the local dealer where you purchased the tool).

A. Using PayPal

1. Tap “Renewal” on the update page to navigate to the renewal type selection screen.
2. Select “PayPal”, and then follow the on-screen instructions to finish the transaction.
3. After payment, go to update center to update the diagnostic software.

B. Using Subscription Renewal Card

1. Tap “Renewal” to navigate to the renewal type selection screen.
2. Select “Subscription Renewal Card”.

< **Renewal Type**

SN: 986390000200
Expiration Date: 2019-05-02 07:59:59
Software Name:

1. PayPal Pay

LAUNCH
Software Update
Renewal

Fee: 



2. Subscription Renewal Card Pay

LAUNCH

Please buy it from local dealer, after activated you can use it free within one year or two years.

[Subscription Renewal Card](#)

< **Subscription Renewal Card**



Please enter 24 Subscription Renewal Card Pin code

SUBMIT

3. Input the 24-digit pin code of Subscription Renewal Card and then tap "Submit" to finish the renewal.
4. Go to update center to update the diagnostic software.

8 My Report

This option is used to view, delete or share the saved reports.

Tap “**My Report**”, there are total 3 options available.

In case the DTC result is saved on Read Trouble Code page, the files will be listed under **Health Reports** tab.



- To select certain report, check the box before the report. To select all reports, tap “Select All”. To deselect all, tap “Unselect”.
- To share the report with others, select the desired one and then tap “Share”.
- Select the desired report and then tap “Delete” to delete it.
- To revise the filename of the report, tap “Rename”.







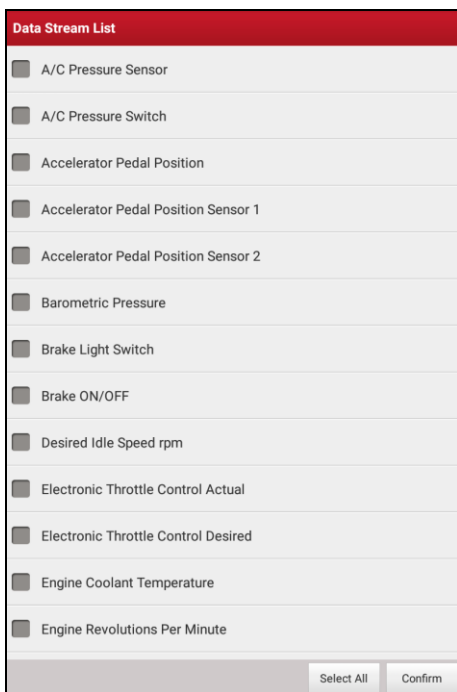

If user records the running parameters while reading data stream, it will be



saved as .x431 file and appear under **Recorded Data** tab.

Tap the desired one to enter:



Select the desired data stream items and tap “Confirm” to jump to the playback page:

Diagnostic Record			
Name	Value	Unit	
A/C Pressure Sensor	2413.25	Kpa	
A/C Pressure Switch	Closed (High)		
Accelerator Pedal Position	68.63	%	
Accelerator Pedal Position Sensor 1	44.18	V	
Accelerator Pedal Position Sensor 2	44.18	V	
Barometric Pressure	120.66	Kpa	
Brake Light Switch	On		
Brake ON/OFF	On		
Desired Idle Speed rpm	3300	rpm	
Electronic Throttle Control Actual	87.50	Deg	
Electronic Throttle Control Desired	87.50	Deg	
Auto Playback(x1) temperature	135	degree C	0/33

 Combine
 Value

Frame Playback

On-screen Buttons:

 **Graph** – displays the parameters in waveform graphs.

Value – this is the default mode which displays the parameters in texts and shows in list format.

Combine – this option is mostly used in graph merge status for data comparison. In this case, different items are marked in different colors.

Frame Playback – plays back the recorded data stream items frame by frame. Once it is in frame playback mode, this button changes into “Auto Playback”.

Remote Reports lists all diagnostic reports generated in process of remote diagnosis.

9 User Info

This function allows users to manage personal information and VCI.

9.1 VCI

This option allows you to manage all your activated VCI devices.

If several VCI devices are activated on this tool, a list of VCIs will be displayed on the screen. Once you choose the VCI that belongs to other account, you have to log out, and then input the right account to continue.

9.2 VCI Management for Passenger Vehicle Configuration

This option is used for the tablet to deactivate pairing up with the VCI device via Bluetooth.

9.3 VCI Management for Commercial Vehicle Configuration

This option is used to set the communication method between the tablet and the VCI module.

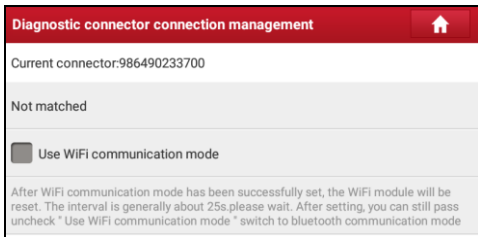

To ensure the tablet can work with the VCI module via Wi-Fi communication, please follow the steps below to proceed:

1. Check the box “Use Wi-Fi communication mode”, the system will search for VCI module automatically.

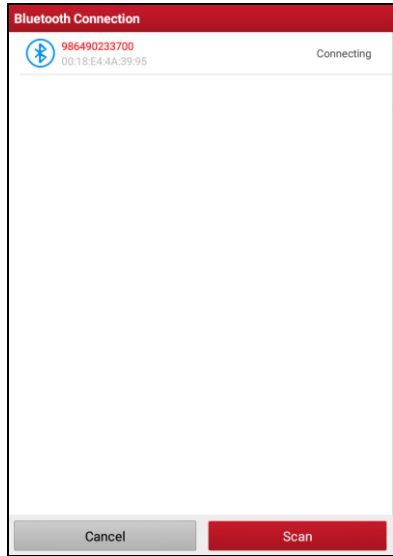

2. Tap the desired VCI module and a pairing request similar to the following prompt window will appear:

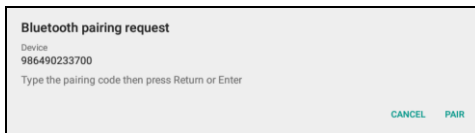

3. Tap "PAIR" to start pairing. Once the pairing is successfully done, the screen displays:

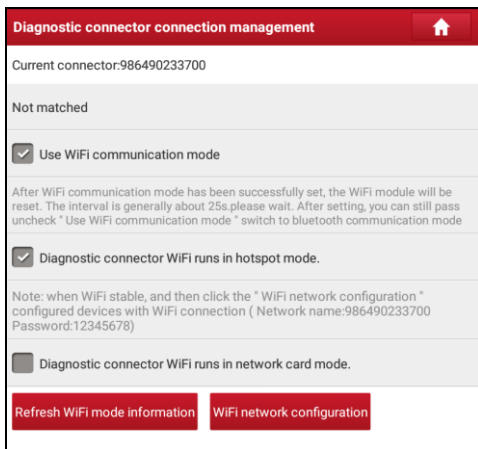

4. There are two Wi-Fi communication modes available for the VCI module.

- **Work as Wi-Fi hotspot:** Once enabled, the VCI module and the tablet automatically connect and form a LAN network to make communication. In this case, the tablet cannot surf the Internet.
- **Work as network adaptor:** Once enabled, a Wi-Fi connection dialog box appears:

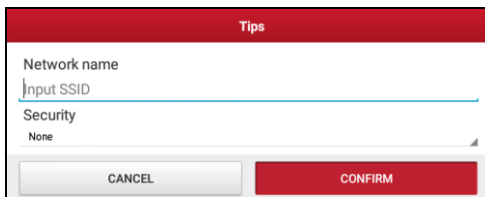

Input the Wi-Fi network name and access password (if the network is encrypted) until it is properly connected. In this case, the tablet can surf the Internet and communicate with the VCI module.

 Note: Please be sure to keep the VCI powered on while performing the operation.

9.4 Activate VCI

This item lets you to activate a new VCI device.

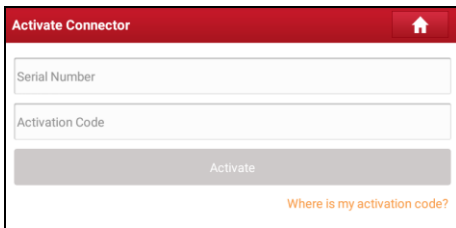

Input the Serial Number and Activation Code, and then tap “Activate” to activate the connector.

For details on how to obtain Activation Code, tap the link below to get help.

9.5 Firmware Fix

Use this item to upgrade and fix diagnostic firmware. During fixing, please do not cut power or switch to other interfaces.

9.6 My News

This option allows you to receive some commercial and promotional activity messages.

9.7 Data Stream Sample

This feature allows you to manage the recorded data stream sample files.

9.8 My Order

This item allows you to check the status of all your orders.

9.9 Subscription Renewal Card

This item is used to check the status of the subscription renewal card.

Input the 12-digit subscription renewal card number. Tap “Search” to get the search result.

9.10 Profile

Use this item to view and configure personal information.

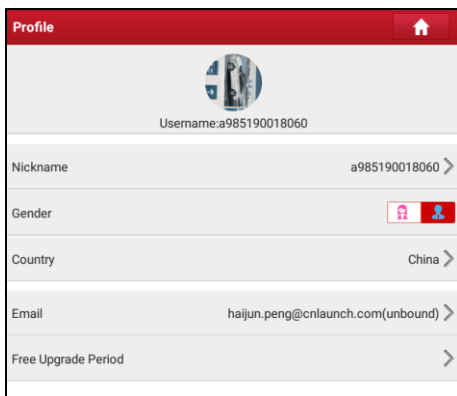

- Tap the user image to change it.
- Tap > next to “Free Upgrade Period” to check the due date of all diagnostic software.

9.11 Change password

This item allows you to modify your login password.

9.12 Settings

It enables you to make some application settings and view software version information etc.

9.12.1 Units

It is designed to configure the measurement unit. Metric System and English System are available.

9.12.2 Shop Information

This option lets you define your print information. It mainly includes Workshop, Address, Telephone, Fax and License Plate.

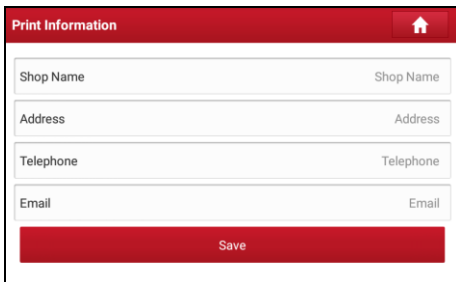

Print Information

Shop Name Shop Name

Address Address

Telephone Telephone

Email Email

Save

After inputting, tap “Save”.

Once you saved the print information, it will be entered automatically in the “Add Information” box every time you save the diagnostic report.

9.12.3 Printer Set

This option is designed to establish a wireless connection between the tablet and the Wi-Fi printer (sold separately) while performing printing operations.

The App is compatible with the “LAUNCH Wi-Fi Printer” (sold separately) and “System” (external printer).

For LAUNCH Wi-Fi mini printer, follow the steps below to connect the printer.

1. Tap **Printer Set**.

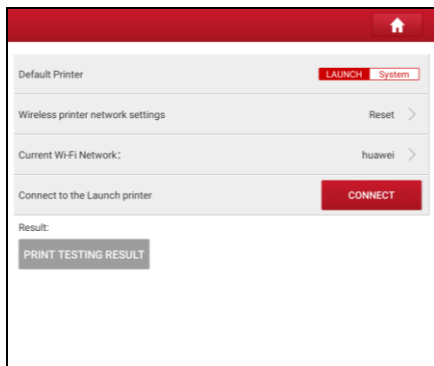

Default Printer LAUNCH System

Wireless printer network settings Reset >

Current Wi-Fi Network: huawei >

Connect to the Launch printer CONNECT

Result:

PRINT TESTING RESULT

A. If it is the first time you have operated this printer, please proceed the following:

1. For initial use, you are suggested to reset the printer: Press and hold [MODE] & [FEED] for 8 seconds, the following resetting command will be printed out:

at + default = 1

ok

at + reboot = 1

rebooting...

2. Tap **Reset** to configure Wi-Fi printer.

Step 1: Connect the printer:

Tap **Scan** to start scanning and select the desired printer hotspot named with X-431PRINTER-XXXX (XXXX stands for 4 characters), and then tap **Connect** to enter Step 2.

Step 2: Join the Wi-Fi printer into LAN:

Tap **Scan** to select the desired local Wi-Fi network from the list, and type in the security password (If it is an open network, password is not required), and then tap **Confirm**.

3. Once the Wi-Fi network of the printer is connected and the printer is found, tap **Printing test** to test the printing.

Now the Wi-Fi printer is ready for printing.

If the printer is not found, please reset the printer to default factory settings (refer to Step 2 for details) and check whether the current device and the printer are on the same LAN.

B. If you have configured the Wi-Fi printer to the LAN:

2. Tap **Connect to Printer**:

a). If the local network remains as it is, tap **Test Print** directly to test the printing.

b). If the local network changes, you have to reset the Wi-Fi printer.

For other Wi-Fi printers,

Before printing, make sure the following conditions are met:

- The Wi-Fi printer is powered on and working normally.
- The print service plug-in associated with the printer is already installed on the tablet (Go to Google Play or use the Browser to download and install it).

Follow the steps below to proceed:

1. Set the default printer as **System**.
2. Go to **Settings -> Network & Internet -> WLAN**, set the WLAN switch to Off.
3. On the report details page, tap .

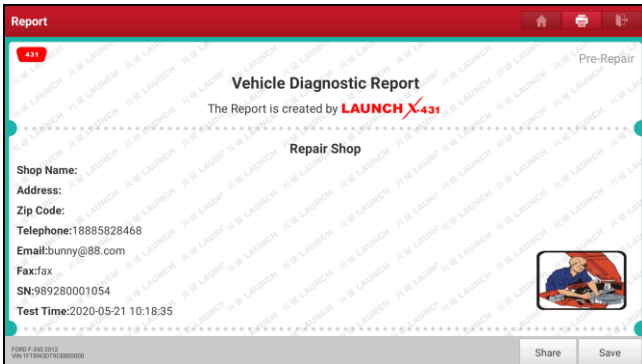

4. Touch  next to **Select a printer** on the upper left corner of the screen.

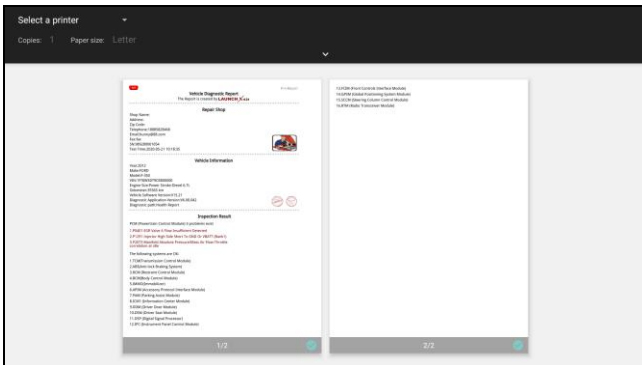

5. Select **All Printers -> Add printer** and enable the installed printer service, the system starts searching for all available Wi-Fi printers of the brand.

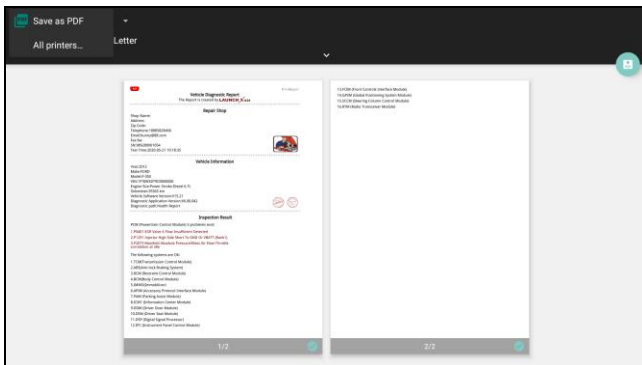

6. Select the desired Wi-Fi printer from the list. If the chosen Wi-Fi printer hotspot is open, the tablet can connect it directly. If it is encrypted, a password may be required. Refer to the Wi-Fi printer user manual to get the default password.
7. Now the printer is ready for printing.
8. Alternatively, you can also choose **Save as PDF** to save the current diagnostic report as a PDF file for later printing.

9.12.4 Orientation

The option is used to set the screen display orientation.

9.12.5 Clear Cache

This option allows you to clear the App cache. Clearing the cache will restart the App.

9.12.6 About

The software version information and disclaimer are included.

9.12.7 Diagnostic Software Auto Update

This option is used to set whether automatic update function is ON.

9.12.8 Login/Logout

To logout the current user ID, tap "Logout".

To login the system again, tap "Login".

9.13 Diagnostic Software Clear

This item allows you to hide/clear the diagnostic software that is not frequently used.

 Note: Removing software may completely delete the software from the tablet. If some software is not used and the tablet runs out of space, you can use this feature to remove it. To re-download it, go to “Software Update” -> “All Software”.

10 Videoscope

10.1 Introduction

The videoscope function is a software application that applies to invisible parts of an engine, such as fuel tank, braking system. With the help of an automotive videoscope (purchased separately), you can testify the existence of internal carbon deposit and damage inside the engine freely.

The videoscope is mainly consisted of an inspection camera, a flexible tube and a data cable. The water-resistant camera lens with adjustable LED lights can increase visibility to areas that cannot be seen in wet, dark, fluid soaked places, while the flexible tube stretches your access to hard-to-reach areas.

In addition, the captured pictures and videos also provide you intuitive data for easy analysis.

10.2 Connections & Operations

To perform a videoscope inspection:

1. Insert the data cable of the videoscope into the charging/data I/O port of port of the tablet.
2. Bend the neck of the flexible tube as desired and extend the camera with adjustable LED lights to some unseen or unreachable parts of engine, hydraulic system, nozzles etc.
3. After connections are properly made and turn the tablet on. Go to **Others -> Videoscope** to run it, then the screen will display the scene captured from the videoscope camera.
5. Adjust it until the lens stops in the desired place and then use the dial for LED light brightness to adjust the brightness.
6. Press the Snapshot button on the videoscope to take a photo. Alternatively, you can also press the Snapshot button on the tablet to take photos.

To record a video, switch from Camera mode to Video mode and tap the Record button on the screen to start recording.

Images are captured in .jpg format and videos are recorded in .avi or .mp4 format. All photographings and videos are saved in DCIM folder where users can browse and replay it.

11 Synchronization

You can transfer media files, screenshots and APK between the PC and tablet.

1. Connect one end of the included charging/data cable to the charging/data I/O port of the tablet, and the other end to the USB port of the PC.
2. Swipe the tablet screen from the top, a pull-down option list will appear on the screen.

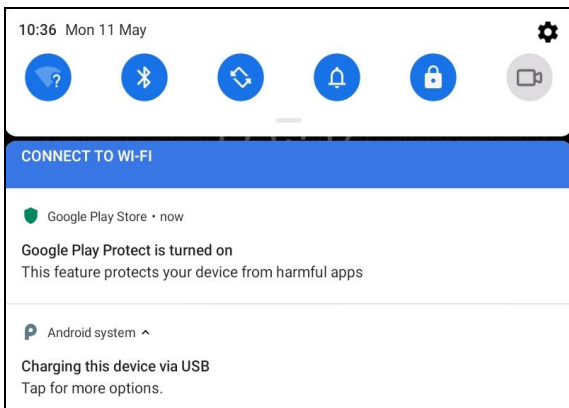

3. Tap **Charging this device via USB**, the following setting options will be displayed on the screen.

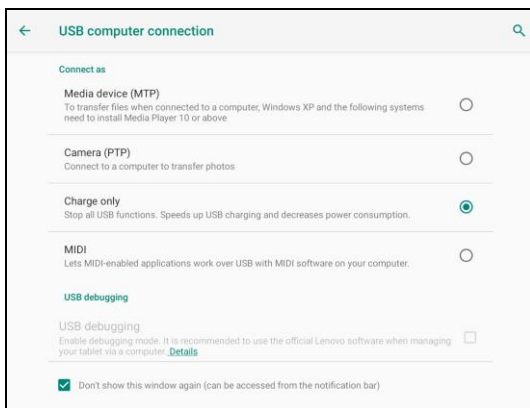

4. Select the checkbox “Media device (MTP)” under the **Connect as** tab.
5. Now you can transfer files between the tablet and PC.

12 FAQ

1. How to save power?

- Please turn off the screen while the tool keeps idle.
- Set a shorter standby time.
- Decrease the brightness of the screen.
- If WLAN connection is not required, please turn it off.

2. Why cannot the tool communication with vehicle ECU?

Please confirm:

1. Whether diagnostic connector is correctly connected.
2. Whether ignition switch is ON.
3. If all checks are normal, send vehicle year, make, model and VIN number to us using Feedback feature.

3. What if I failed to enter the vehicle ECU system?

Please confirm:

1. Whether the vehicle is equipped with this system.
2. Whether the VCI dongle is correctly connected.
3. Whether ignition switch is ON.
4. If all checks are normal, send vehicle year, make, model and VIN number to us using Feedback feature.

4. How to reset the tablet?

 Resetting may cause data loss. Before doing so, please make sure important data and information has been backed up.

Do the following to reset the tablet:

1. Tap "Settings" -> "Back & Reset".
2. Tap "Factory data reset".
3. Tap "Reset tablet".
4. Tap "Clear all data" to start resetting until the tool automatically reboots.

5. How to download the X-431 V+ V4.0 App after resetting the tablet?



Note: Before registration, please make sure the network is properly connected.

After the tablet has been successfully reset, follow the steps below to download the App:

1. Launch the browser and the default official Launch website opens (If a blank page pops up, just type in www.x431.com in the input bar).
2. Tap "Login", input the username and password and tap "Log In."
3. Make sure that the serial number is correct, tap "APP application program" and tap the Download icon to start downloading.
4. After the download is complete, follow the on-screen instructions to install it.
5. After installation, use the existing username and password to login and go to update center to download the diagnostic software.

6. What if the language of vehicle diagnostic software does not match with the system language?

English is the default system language of the tool. After the system language is set to the preference language, please go to the update center to download the vehicle diagnostic software of the corresponding language.

If the downloaded diagnostic software is still displayed in English, it indicates that the software of the current language is under development.

7. How to retrieve the login password?

Please follow below steps to proceed in case you forgot the login password:

1. Tap the application icon on the home screen to launch it.
2. Tap [Login] button on the upper right corner of the screen.
3. Tap "Retrieve password".
4. Input product S/N and follow the on-screen prompts to retrieve the password.

Warranty

THIS WARRANTY IS EXPRESSLY LIMITED TO PERSONS WHO PURCHASE LAUNCH PRODUCTS FOR PURPOSES OF RESALE OR USE IN THE ORDINARY COURSE OF THE BUYER'S BUSINESS.

LAUNCH electronic product is warranted against defects in materials and workmanship for one year from date of delivery to the user.

This warranty does not cover any part that has been abused, altered, used for a purpose other than for which it was intended, or used in a manner inconsistent with instructions regarding use. The exclusive remedy for any automotive meter found to be defective is repair or replacement, and LAUNCH shall not be liable for any consequential or incidental damages.

Final determination of defects shall be made by LAUNCH in accordance with procedures established by LAUNCH. No agent, employee, or representative of LAUNCH has any authority to bind LAUNCH to any affirmation, representation, or warranty concerning LAUNCH automotive meters, except as stated herein.

Disclaimer

The above warranty is in lieu of any other warranty, expressed or implied, including any warranty of merchantability or fitness for a particular purpose.

Purchase Order

Replaceable and optional parts can be ordered directly from your LAUNCH authorized tool supplier. Your order should include the following information:

- Order quantity
- Part number
- Part name

Customer Service

Any question during the operation, please call +86-755-84557891 or send Email to our official after-sale service email address: overseas.service@cnlaunch.com.

If your unit requires repair service, return it to the manufacturer with a copy of the sales receipt and a note describing the problem. If the unit is determined to be in warranty, it will be repaired or replaced at no charge. If the unit is determined to be out of warranty, it will be repaired for a nominal service charge plus return freight. Send the unit pre-paid to:

Attn: Customer Service Department

LAUNCH TECH CO., LTD.

Launch Industrial Park,
North of Wuhe Avenue,
Banxuegang, Bantian,
Longgang, Shenzhen, Guangdong
P.R.China, 518129

Launch website: <http://www.cnlaunch.com>

<http://www.x431.com>

Statement:

The document is subject to changes without notice due to continuing progress in design, methodologies and manufacturing. We shall have no liability to the damage or errors resulting from the use of this document.