

Version: V1.00.001
Revised date: 2019-10-15

Statement: LAUNCH owns the complete intellectual property rights for the software used by this product. For any reverse engineering or cracking actions against the software, LAUNCH will block the use of this product and reserve the right to pursue their legal liabilities.

Copyright Information

Copyright © 2019 by LAUNCH TECH CO., LTD. All rights reserved. No part of this publication may be reproduced, stored in a retrieval system, or transmitted in any form or by any means, electronic, mechanical, photocopying, recording or otherwise, without the prior written permission of LAUNCH. The information contained herein is designed only for the use of this unit. LAUNCH is not responsible for any use of this information as applied to other units.

Neither LAUNCH nor its affiliates shall be liable to the purchaser of this unit or third parties for damages, losses, costs, or expenses incurred by purchaser or third parties as a result of: accident, misuse, or abuse of this unit, or unauthorized modifications, repairs, or alterations to this unit, or failure to strictly comply with LAUNCH operating and maintenance instructions. LAUNCH shall not be liable for any damages or problems arising from the use of any options or any consumable products other than those designated as Original LAUNCH Products or LAUNCH Approved Products by LAUNCH.

Trademark Information

LAUNCH is a registered trademark of LAUNCH TECH CO., LTD. (also called LAUNCH for short) in China and other countries. All other LAUNCH trademarks, service marks, domain names, logos, and company names referred to in this manual are either trademarks, registered trademarks, service marks, domain names, logos, company names of or are otherwise the property of LAUNCH or its affiliates. In countries where any of the LAUNCH trademarks, service marks, domain names, logos and company names are not registered, LAUNCH claims other rights associated with unregistered trademarks, service marks, domain names, logos, and company names. Other products or company names referred to in this manual may be trademarks of their respective owners. You may not use any trademark, service mark, domain name, logo, or company name of LAUNCH or any third party without permission from the owner of the applicable trademark, service mark, domain name, logo, or company name. You may contact LAUNCH by visiting the website at www.cnlaunch.com, or writing to LAUNCH TECH CO., LTD., Launch Industrial Park, North of Wuhe Avenue, Banxuegang, Bantian, Longgang, Shenzhen, Guangdong, P.R.China, to request written permission to use Materials on this manual for purposes or for all other questions relating to this manual.

Important Safety Precautions

Important: To avoid personal injury, property damage, or accidental damage to the product, read all of the information in this section before using the product.

- Never collide, throw, or puncture the tool, and avoid falling, extruding and bending it.
- Do not insert foreign objects into or place heavy objects on your device. Sensitive components inside might cause damage.
- Do not use the tool in exceptionally cold or hot, dusty, damp or dry environments.
- In places using the tool may cause interference or generate a potential risk, please turn it off.
- The tool is a sealed unit. There are no end-user serviceable parts inside. All internal repairs must be done by an authorized repair facility or qualified technician. If there is any inquiry, please contact the dealer.
- Never place the tool into apparatus with strong electromagnetic field.
- Keep the tool far away from magnetic devices because its radiations can damage the screen and erase the data stored on the tool.
- **DANGER:** Do not attempt to replace the internal rechargeable lithium battery. Contact the dealer for factory replacement.
- **CAUTION:** Please use the included battery and charger. Risk of explosion if the battery is replaced with an incorrect type.
- Do not delete unknown files or change the name of files or directories that were not created by you, otherwise the tool software might fail to work.
- Be aware that accessing network resources can leave the tool vulnerable to computer viruses, hackers, spyware, and other malicious activities that might damage your device, software or data. It is your responsibility to ensure that you have adequate protection in the forms of firewalls, antivirus software, and anti-spyware software and keep such software up to date.

Precautions on using the tool

Before using this test equipment, please read the following safety information carefully.

- Always perform automotive testing in a safe environment.

- If the VCI device remains unused for a long period of time, it is suggested to unplug the connector from vehicle's DLC to conserve battery power.
- Wear an ANSI-approved eye shield when testing or repairing vehicles.
- The vehicle shall be tested in a well-ventilated work area, as engines produce various poisonous compounds (hydrocarbon, carbon monoxide, nitrogen oxides, etc.)
- Do not connect or disconnect any test equipment while the ignition is on or the engine is running.
- Put blocks in front of the drive wheels and never leave the vehicle unattended while testing.
- Keep the test equipment dry, clean, free from oil, water or grease. Use a mild detergent on a clean cloth to clear the outside of the equipment as necessary.
- Do not drive the vehicle and operate the test equipment at the same time. Any distraction may cause an accident.
- Keep clothing, hair, hands, tools, test equipment, etc. away from all moving or hot engine parts.
- Before starting the engine, put the gear lever in the Neutral position (for manual transmission) or in the Park (for automatic transmission) position to avoid injury.
- To avoid damaging the test equipment or generating false data, please make sure the vehicle battery is fully charged and the connection to the vehicle DLC (Data Link Connector) is clear and secure.
- Automotive batteries contain sulfuric acid that is harmful to skin. In operation, direct contact with the automotive batteries should be avoided. Keep the ignition sources away from the battery at all times.

Precautions on operating vehicle's ECU

- Do not disconnect battery or any wiring cables in the vehicle when the ignition switch is on, as this could avoid damage to the sensors or the ECU.
- Do not place any magnetic objects near the ECU. Disconnect the power supply to the ECU before performing any welding operations on the vehicle.
- Use extreme caution when performing any operations near the ECU or sensors. Ground yourself when you disassemble PROM, otherwise ECU and

sensors can be damaged by static electricity.

- When reconnecting the ECU harness connector, be sure it is attached firmly, otherwise electronic elements, such as ICs inside the ECU, can be damaged.

Contents

1 Introductions	1
1.1 Product Profile.....	1
1.2 Features	1
1.3 Components & Controls.....	2
1.3.1 Display tablet	2
1.3.2 VCI device (Only applies to 12V cars).....	4
1.4 Technical Parameters	4
1.5 Package List.....	5
2 Preparations	7
2.1 Charging the tool.....	7
2.2 Using your battery	7
2.3 Power on/off.....	7
2.3.1 Power on.....	7
2.3.2 Power off.....	7
2.4 Tips on finger operations	8
2.5 Screen layout	8
2.6 Adjust brightness.....	9
2.7 Set standby time	9
3 Network Setup	10
3.1 Connect to a WLAN network.....	10
3.2 Disconnect from a WLAN network.....	10
4 How To Diagnose	11
4.1 Diagnosis Flowchart.....	11
4.2 Initial Use	11
4.2.1 User registration	11
4.2.2 Diagnostic software layout.....	15
4.2.3 Job menu	15
4.2.4 Diagnostics toolbar	16
4.3 Connections	17
4.3.1 Preparation	17
4.3.2 DLC location	17
4.3.3 Vehicle connection.....	18
4.4 Communication Setup.....	19
4.5 Start Diagnostics	20
4.5.1 Health Report (Quick Test)	21
4.5.2 System Scan.....	24
4.5.3 System Selection.....	25

5 Special (Reset) Function	33
5.1 Oil Reset Service	34
5.2 Electronic Parking Brake Reset	34
5.3 Steering Angle Calibration	35
5.4 ABS Bleeding	35
5.5 Tire Pressure Monitor System Reset	35
5.6 Gear Learning	35
5.7 IMMO Service	36
5.8 Injector Coding	36
5.9 Battery Maintenance System Reset	37
5.10 Diesel Particulate Filter (DPF) Regeneration.....	37
5.11 Electronic Throttle Position Reset.....	38
6 Remote Diagnosis.....	39
6.1 Interface layout.....	39
6.2 Add friends.....	40
6.3 Start Instant Messaging	41
6.4 Launch Remote Diagnosis (Device-To-Device).....	43
7 Software Update	46
7.1 Update Diagnostic Software & APP.....	46
7.2 Renew Subscription	47
8 Maintenance Help.....	49
9 Personal Center	50
9.1 My report	50
9.2 My connector.....	51
9.3 Activate connector.....	51
9.4 Firmware fix.....	51
9.5 Feedback	51
9.6 My order	52
9.7 Inquire subscription renewal card status	52
9.8 Profile	52
9.9 Change password	52
9.10 Settings	52
9.10.1 Units of measurement	52
9.10.2 Print information	53
9.10.3 Launch printer connection	53
9.10.4 About.....	55
9.10.5 Exit.....	55
10 Others	56

10.1 Synchronization.....	56
10.1.1 Connect to PC	56
10.1.2 Run on PC	56
10.1.3 Install an application	56
10.2 Clear Cache	56
11 FAQ.....	57

1 Introductions

1.1 Product Profile

X-431 PROS MINI V3.0 is a stylish Android-based vehicle trouble diagnostic tool. It inherits from LAUNCH's advanced diagnosing technology and is characterized by covering a wide range of vehicles, featuring powerful functions, and providing precise test result.

Through the simple wireless (BT) communication between the VCI device and the tablet, it achieves full car model and full system vehicle trouble diagnosis, which includes Reading DTCs, Clearing DTCs, Reading Data Stream, Actuation Test and Special Functions.

Moreover, it supports WLAN connection, which enables you to surf the Internet, update the diagnostic software online and perform remote diagnosis etc, getting your job fixed faster and easier.

1.2 Features

1. Diagnostic Tool:

A. Diagnose

- ♦ Diagnose the electronic control system of prevailing vehicle models covering Asian, European, American and Chinese. Diagnosis functions include: Read DTCs, Clear DTCs, Read data stream, Special functions etc.
- ♦ Specially designed for Android platform with clear and user-friendly interface.

B. One-click Update: Lets you update your diagnostic software and APK more efficiently.

C. Repair Data: Provides abundant automotive handbook, repair case and wiring diagrams for reference and retrieval.

D. Remote Diagnosis: Configures the tool as I/M (Instant Messaging) tool, which enables technicians to exchange repair experience and perform remote assistance more conveniently.

- ### 2. Browser:
- Built-in wireless communication module makes surfing on the internet freely.

3. Settings: to configure your personalized tablet through it.
4. Applications: other android based applications can be customized to install or uninstall.

1.3 Components & Controls

There are two main components to the X-431 PROS MINI V3.0 system: Display tablet and VCI device.

1.3.1 Display tablet

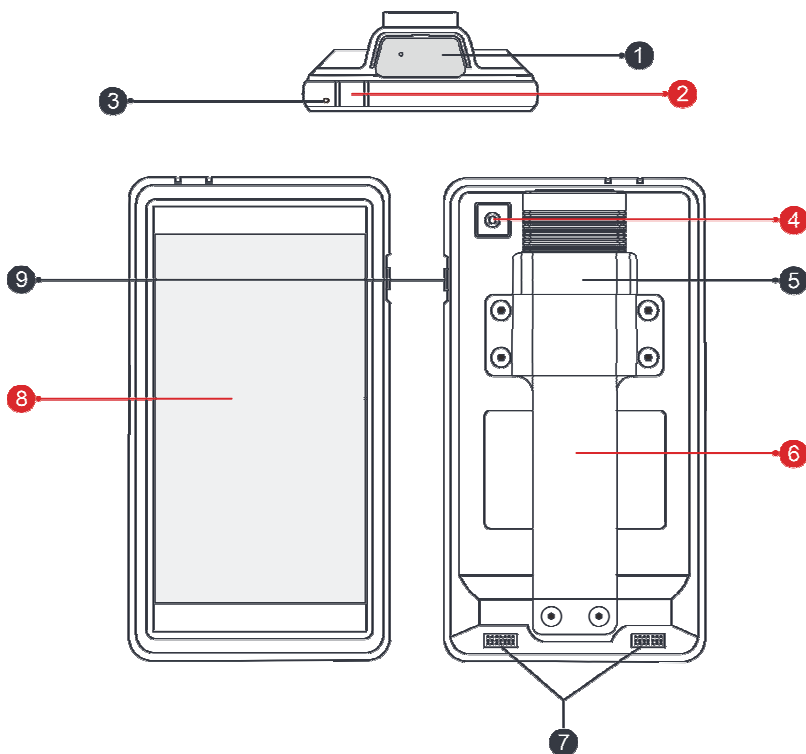

Fig. 1-1 X-431 PROS MINI V3.0 tablet

1	VCI device	
2	Charging/Data I/O port	To connect to the power adaptor/PC for charging/data exchange.
3	Microphone	
4	Rear camera	
5	Slot for VCI device	For housing the VCI device.
6	Carry strap	
7	Speakers	
8	LCD screen	
9	POWER/Screen lock button	In Off mode, press it to turn the tablet on. In On mode, turn the tablet off with long press or lock screen with short press.

1.3.2 VCI device (Only applies to 12V cars)

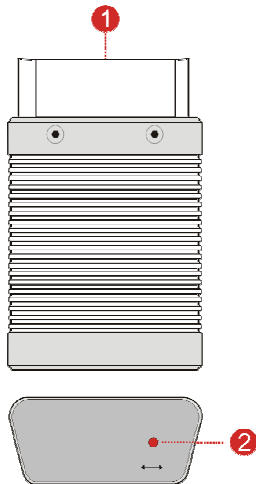

Fig. 1-2 VCI device

- | | | |
|---|------------------------------------|------------------------------------------------------------------------------------------------------------------------------------------------------------------------------------------------------------------------|
| 1 | OBD-16 diagnostic connector | To connect on vehicle's OBD II DLC. |
| 2 | Mode indicator | <ul style="list-style-type: none"> • It illuminates red when the VCI device is connected to the vehicle's DLC. • Blue indicates the VCI device is working in wireless (BT) communication mode. |

1.4 Technical Parameters

Display tablet:

Operating system	Android
-------------------------	---------

Memory	2GB
---------------	-----

Storage	32GB
----------------	------

LCD screen	7 inch with a resolution of 1024 x 600 pixels
-------------------	-----------------------------------------------

Camera	Rear-facing 5MP camera
---------------	------------------------

Connectivity	<ul style="list-style-type: none">♦ WLAN 802.11b/g/n♦ BT 4.0
---------------------	-------------------------------------------------------------------------------------

Working temperature	0°C ~ 50°C
----------------------------	------------

Storage temperature	-20°C ~ 70°C
----------------------------	--------------

VCI device:

Working voltage	9 ~18V
------------------------	--------

Working temperature	0°C ~ 50°C
----------------------------	------------

Relative humidity	20% ~ 90%
--------------------------	-----------

1.5 Package List

While opening the package for the first time, please carefully check the following components. Common accessories are same, but for different destinations, the accessories may vary. Please consult from the local agency or check the package list supplied with this tool together.



- Display tablet
- VCI device (For connecting OBD II vehicles)
- Password envelope (A piece of paper bearing the product Serial Number and Activation Code for product registration.)
- Power adaptors (For charging the tablet via AC outlet.)
- Charging/Data cable
- OBD II extension cable (To connect the VCI connector to the OBD II vehicle's DLC.)
- OBD I adaptor (Optional, for connecting the non-16pin diagnostic connector and the VCI device)

- Non-16pin connectors (Optional, for connecting non-OBD II vehicle)
- Cigarette lighter cable (Optional, to supply power to the non-16pin connector from the vehicle's cigarette lighter receptacle.)
- Battery clamps cable (Optional, to supply power to the non-16pin connector from the vehicle's battery.)

2 Preparations

2.1 Charging the tool

1. Plug one end of the included charging cable into the charging port of the tool, and the other end to the power adaptor.
2. Connect the other end to the AC outlet.

If  appears on the screen, it indicates it is being charged. If the logo changes into , it indicates that the battery is fully charged. Unplug the power adaptor from the tablet.

2.2 Using your battery

- If the battery remains unused for a long period of time or the battery is completely discharged, it is normal that the tool will not power on while being charged. Please charge it for a period of 5 minutes and then turn it on.
- Please use the included power adaptor to charge your tool. No responsibility can be assumed for any damage or loss caused as a result of using power adaptors other than the one supplied.
- While the tablet has low battery, a beep will sound. If it is very low, the tablet will be switched off automatically.

2.3 Power on/off

2.3.1 Power on

Press [POWER] to turn the tool on.

*Note: If it is the first time you have used this tool or the tool remains idle for a long period of time, the tool could fail to turn on. Please charge the tool for a minimum of 5 minutes and attempt to turn on again.

2.3.2 Power off

Press [POWER] for 3 seconds, an option menu will pop up on the screen. Tap "Power off" to turn the tool off.

2.4 Tips on finger operations



Single-tap: To select an item or launch a program.



Double-tap: To zoom in so that the text on a webpage appears in a column that fits your device's screen.



Long press: Tap and hold on the current interface or area until a contextual menu pops up on the screen, and then release it.



Slide: To jump to different pages.



Drag: Tap the application icon and drop it to other location.



Spread apart/pinch together: To zoom in manually, place two fingers on the screen and then spread them apart. To zoom out, place two fingers apart on the screen and then pinch them together.

2.5 Screen layout

There are five on-screen buttons available on the bottom of the screen.



HOME

Tap it to navigate to the Android's home screen.



RECENT APP

Tap it to view the currently running applications.



VCI STATUS

Shows whether the VCI device is properly connected or not.



SCREENSHOT

Tap it to capture the current screen.



BACK

Tap it to return to the previous screen.

2.6 Adjust brightness

 Tips: Reducing the brightness of the screen is helpful to conserve the battery power.

1. On the home screen, tap **Settings -> Display -> Brightness level**.
2. Drag the slider to adjust it.

2.7 Set standby time

If no activities are made within the defined standby period, the screen will be locked automatically and the system enters sleep mode to save power.

1. On the home screen, tap **Settings -> Display -> Sleep**.
2. Choose the desired sleep time.

3 Network Setup

*Note: If you don't need to use WLAN for a while, you can turn it off to conserve battery life.

The tablet has built-in WLAN module that can be used to get online. Once you're online, you can register your tool, surf the Internet, get apps, send email, launch the remote diagnosis, and check for software updates etc.

3.1 Connect to a WLAN network

1. On the home screen, tap **Settings -> WLAN**.
2. Slide the WLAN switch to ON, the tablet starts searching for available wireless networks.
3. Select a wireless network,
 - If the chosen network is open, the tablet will connect automatically;
 - If the selected network is encrypted, a network password will need to be entered.
4. When "Connected" appears, it indicates the connection is complete.

*Note: When WLAN is not required, this should be disabled to conserve battery power.

Once it is connected successfully, tap the WLAN network from the list to view its name, link speed, security type, IP address etc.

When this tool is in range, it will connect to the previously linked network automatically.

3.2 Disconnect from a WLAN network

1. On the home screen, tap **Settings -> WLAN**.
2. Tap the network with a **Connected** status, then tap "Disconnect".

4 How To Diagnose

4.1 Diagnosis Flowchart

For new users, please follow the operation chart shown in Fig. 4-1 to get familiar with and start using the tool.

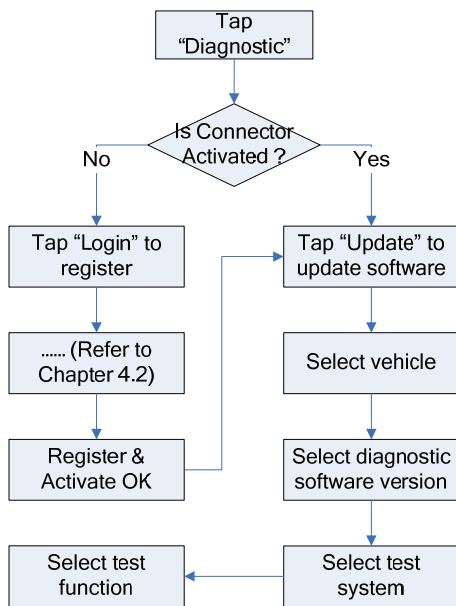

Fig. 4-1

4.2 Initial Use

During initial use, tap the application icon on the home screen to launch it, some illustrations that guide you through some of important operations appear. Scroll the screen and tap on "Start Now" to enter the Job menu.

4.2.1 User registration

Tap "Login" on the upper right corner of the Job menu:

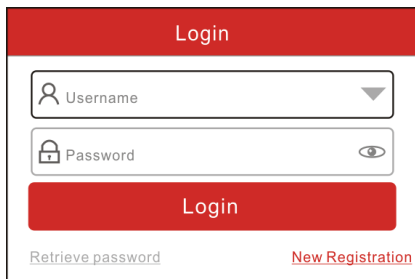

The image shows a login screen with a red header containing the word "Login". Below the header are two input fields: "Username" with a person icon and a dropdown arrow, and "Password" with a lock icon and an eye icon. A red "Login" button is positioned below these fields. At the bottom, there are two links: "Retrieve password" on the left and "New Registration" on the right.

Fig. 4-2

1. If you are a new user, tap "New Registration". See Fig. 4-3.

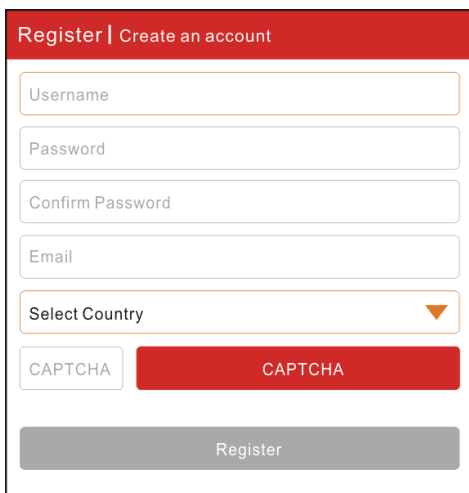

The image shows a registration screen with a red header containing "Register | Create an account". Below the header are five input fields: "Username", "Password", "Confirm Password", "Email", and "Select Country" with a dropdown arrow. Below these fields are two "CAPTCHA" buttons, one in a white box and one in a red box. At the bottom is a large grey "Register" button.

Fig. 4-3

 Note: To obtain better service, you need to provide real information.

- A. Create App account: In Fig. 4-3, fill in the information in each field and then tap "Register", a screen similar to the following will appear:

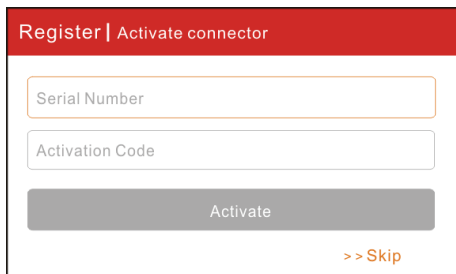

Fig. 4-4

B. Activate the VCI device: In Fig. 4-4, input the Serial Number and Activation Code, which can be found in the password envelope.

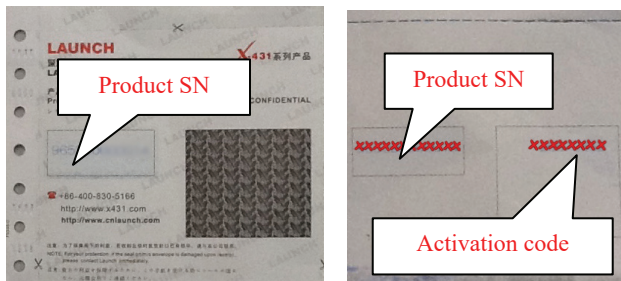



Fig. 4-5

 **Note:** To exit and activate it later, tap “Skip”. In this case, you can activate your connector by tapping “Activate Connector” in “Personal Center”. For details, please refer to Chapter 9.3 Activate Connector.

C. Download diagnostic software: Tap “Activate”, a dialog box similar to Fig. 4-6 will appear:

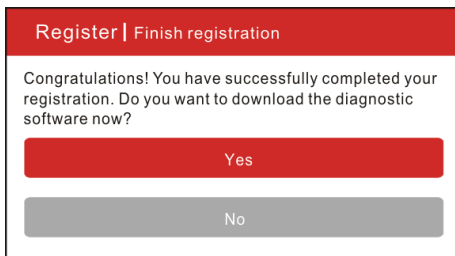

Fig. 4-6

To download the diagnostic software, tap “Yes” to enter the software download page. Tap “No” to download it later.

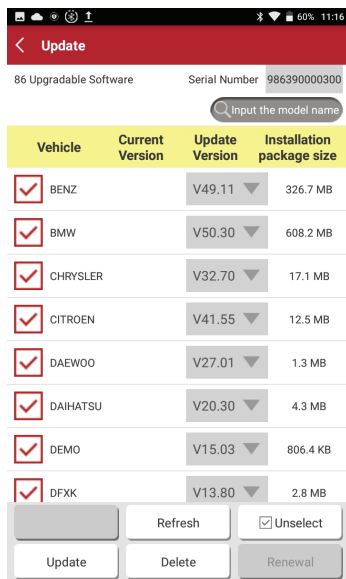

Fig. 4-7

On the download page, tap “Update” to start downloading. It may take several minutes to finish it, please be patient to wait. To pause downloading, tap “Pause”. To resume it, tap “Continue”.

Once download is complete, the system will install the software package automatically.

2. If you have registered to be a member, input your name and password, and then tap the “Login” button to enter the main menu screen directly.
3. If you forgot the password, tap “Retrieve Password”, and then follow the on-screen instructions to retrieve it.

4.2.2 Diagnostic software layout

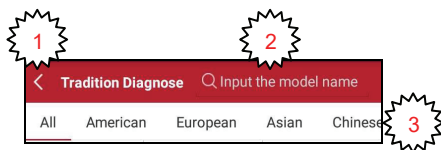

Fig. 4-8

-
- 1 Tap to navigate to the Job menu. Refer to “**Chapter 4.2.3 Job menu**” for details.
 - 2 Search bar: input the desired vehicle model name to locate it quickly.
 - 3 Vehicle region buttons: Tap different buttons to switch to corresponding vehicles.
-

4.2.3 Job menu

It mainly includes the following items:

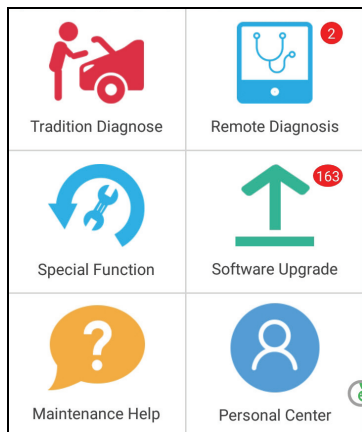



Fig. 4-9

Name	Description
Tradition Diagnose	Configures the tablet to operate as a diagnostic tool.
Remote Diagnosis	This option aims to help repair shops or technicians to get the repair job fixed faster.
Special Function	To perform all kinds of common repair & maintenance items, including ABS bleeding, DPF regeneration, oil lamp reset etc.
Software Upgrade	To update vehicle diagnostic software.
Maintenance Help	Includes How-to Videos, operation skills and user manual etc.
Personal Center	Allows you to configure system settings and manage your personal information.

4.2.4 Diagnostics toolbar

The diagnostics toolbar contains a number of buttons that allow you to print the displayed data or make other controls. It is displayed on the upper right corner of the screen and goes through the whole diagnostic session. The table below

provides a brief description for the operations of the diagnostics toolbar buttons:

Name	Button	Description
Home		Returns to Job menu screen.
Exit		To exit the diagnostic application.

4.3 Connections

4.3.1 Preparation

Normal testing conditions

- Turn on the vehicle power supply.
- Vehicle battery voltage range should be 9-18 Volts.
- Throttle should be in a closed position.

Select the VCI device

If the tool is testing vehicles equipped with universal OBD II 16 PIN diagnostic socket, please use the included VCI device. (For vehicles with non-OBD II 16 PIN diagnostic socket, a non-16 PIN connector is required.)

4.3.2 DLC location

The DLC (Data Link Connector) is typically a standard 16-pin connector where diagnostic tools interface with a vehicle's on-board control modules. The DLC is usually located 12 inches from the center of the instrument panel, under or around the driver's side for most vehicles. If DLC is not located under dashboard, a label should be there telling location. For some Asian and European vehicles, the DLC is located behind the ashtray and the ashtray must be removed to access the connector. If the DLC cannot be found, refer to the vehicle's service manual.

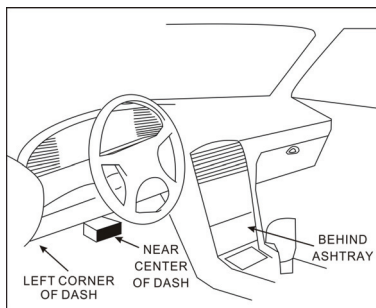

Fig. 4-10

4.3.3 Vehicle connection

The method used to connect the VCI device to a vehicle's DLC depends on the vehicle's configuration as follows:

- A vehicle equipped with an OBD II management system supplies both communication and 12V power through a standardized DLC.
- A vehicle not equipped with an OBD II management system supplies communication through a DLC connection, and in some cases supplies 12V power through the cigarette lighter receptacle or a connection to the vehicle battery.

Follow the steps mentioned below to connect OBD II vehicle:

1. Locate vehicle's DLC socket.
2. Plug the VCI device into the vehicle's DLC socket (It is suggested to use the OBD II extension cable to connect the VCI device and DLC socket.).

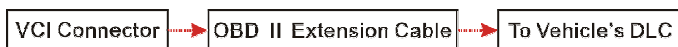

Fig. 4-11

3. Choose one of the two ways to obtain power from:
 - A. Power adaptor: Connect one end of the included power adaptor to charging port of the tablet, and the other end to AC outlet.
 - B. Internal battery pack

For non-OBDII vehicle, proceed as follows:

1. Locate vehicle's DLC socket.

2. Select the corresponding non-16pin connector.
3. Plug the non-16pin end of the connector into the DLC socket, then connect the other end to the OBD I adaptor, and then tighten the captive screws.
4. Connect the other end of the adaptor to the included VCI device.
5. To supply power to OBD I adaptor from:

A. Cigarette Lighter cable (optional): Connect one end of the cigarette lighter cable to vehicle's cigarette lighter receptacle, and the other end to the power jack of OBD I adaptor.

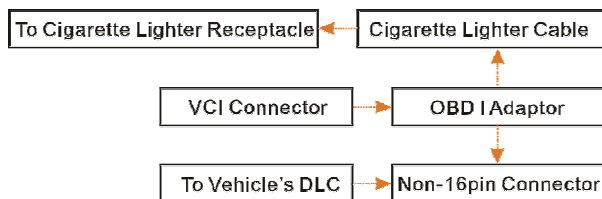

Fig. 4-12

B. Battery Clamps Cable: Connect one end of the battery clamps cable to vehicle's battery, and the other end to the power jack of OBD I adaptor.

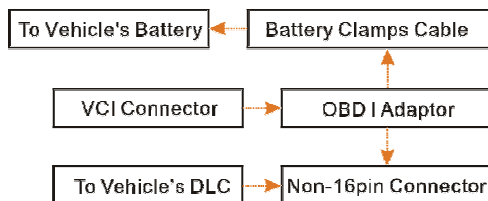

Fig. 4-13

4.4 Communication Setup

Go to "Settings" -> "BLUETOOTH", slide the switch to ON and the tablet will start searching for all available BT devices. Tap the desired VCI from the list to pair.

By default, the VCI ID is 98*****00 (where ***** stands for 8 digits).

*Note: In case no communication setup is done before diagnostic software is launched, you can also configure it while using the software.

4.5 Start Diagnostics

Tap “Tradition Diagnose” to enter the vehicle selection page.

Tap a corresponding diagnostic software logo, and then follow the on-screen instruction to access the diagnostic software.

Take Demo as an example to demonstrate how to diagnose a vehicle.

1. Tap “DEMO” to navigate to the version selection screen. (Note: No communication should be established for DEMO program.)

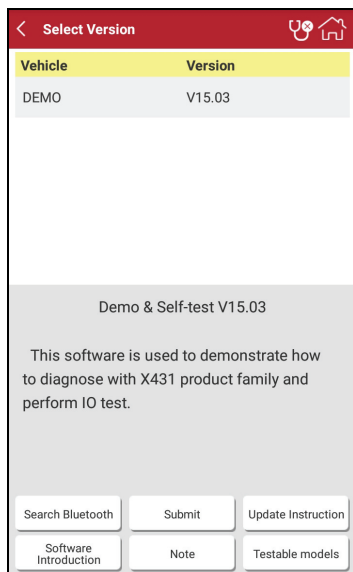

Fig. 4-14

On-screen Buttons:

Search BT: Tap to search for the available VCI connector.

*Note: If a vehicle is tested and no communication setup is done before diagnosis, tap “Search BT”. Tap “Scan” to start searching for the VCI. Once it is found, tap it to start pairing. If the handset has paired with the VCI, it will enter Step 2 directly.

Submit: Tap it to go to next step.

Update instruction: Tap to view the optimized items and enhancements.

Software introduction: Tap to check the software function list.

Note: Tap to read some precautions on using the current diagnostic software.

Testable models: Tap to view the vehicle models that the current diagnostic software covers.

2. Tap “Submit” to navigate to the test item selection screen.

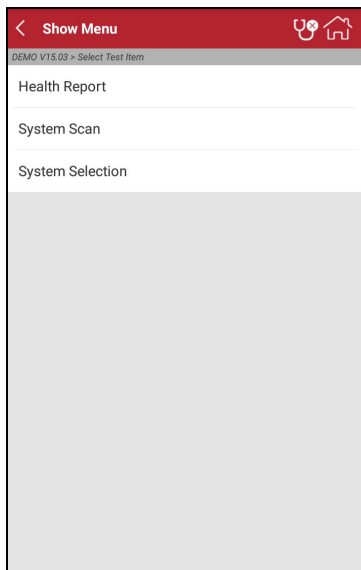

Fig. 4-15

- **Health report:** This function varies from vehicle to vehicle. It enables you to quickly access all the electronic control units of the vehicle and generate a detailed report about vehicle health. Refer to Chapter 4.5.1.
- **System Scan:** This option allows you to quickly scan which systems are installed on the vehicle. Refer to Chapter 4.5.2.
- **System Selection:** This option allows you manually select the test system and function step by step. Refer to Chapter 4.5.3.

4.5.1 Health Report (Quick Test)

This function varies from vehicle to vehicle. It enables you to quickly access all

the electronic control units of the vehicle and generate a detailed report about vehicle health.

Tap “Health Report”, the system start scanning the ECUs and the screen displays as follows:

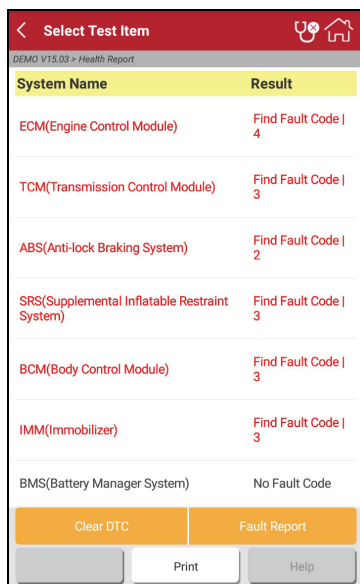

System Name	Result
ECM(Engine Control Module)	Find Fault Code 4
TCM(Transmission Control Module)	Find Fault Code 3
ABS(Anti-lock Braking System)	Find Fault Code 2
SRS(Supplemental Inflatable Restraint System)	Find Fault Code 3
BCM(Body Control Module)	Find Fault Code 3
IMM(Immobilizer)	Find Fault Code 3
BMS(Battery Manager System)	No Fault Code

Clear DTC Fault Report

Print Help

Fig. 4-16

In Fig. 4-16, the tested system with fault code appears in red and the system with OK displays in black (normally).

On-screen Buttons:

Print: Tap to print the current screen. To perform printing, you need to purchase an extra mini printer manufactured by LAUNCH separately and then properly configure the wireless printer following the steps described in Chapter 9.10.3.

Clear DTC: Tap to clear the existing diagnostic trouble codes.

Fault Report: Tap to view the health report in details.

Fault	Normal
ECM(Engine Control Module)	DTC (4) ▶
TCM(Transmission Control Module)	DTC (3) ▶
ABS(Anti-lock Braking System)	DTC (2) ▶
SRS(Supplemental Inflatable Restraint System)	DTC (3) ▶
BCM(Body Control Module)	DTC (3) ▶
IMM(Immobilizer)	DTC (3) ▶
TPMS(Tire Pressure Monitoring System)	DTC (2) ▶
SAS(Steering Angle System)	DTC (3) ▶

Search Report Help

Fig. 4-17

On-screen Buttons:

Search: Highlight a certain DTC item, and then tap it to launch the browser to search for more detailed information about the selected DTC online.

Report: To save the current data in text format.

ADD INFORMATION

1E4GEAK12FT00001X

Owner name:

License #:

Tester:

Remark:

SKIP CONFIRM

Fig. 4-18

Input the required information, and then tap “Confirm” to save it.

Once you configured the information, it will be automatically generated every time you saved the diagnostic report. All vehicle and workshop information will be appended to the diagnostic report.

To skip the information, tap “Skip” to go to the next step.

All reports are saved under the tab “Diagnostic Report” in “My Report” from “Personal Center” menu. For details on report operations, please refer to Chapter 9.1 “My Report”.

4.5.2 System Scan

This option allows you to quickly scan which systems are installed on the vehicle.

In Fig. 4-15, tap “System Scan”, the system start scanning the systems. Once the scanning is complete, the screen will display the result.

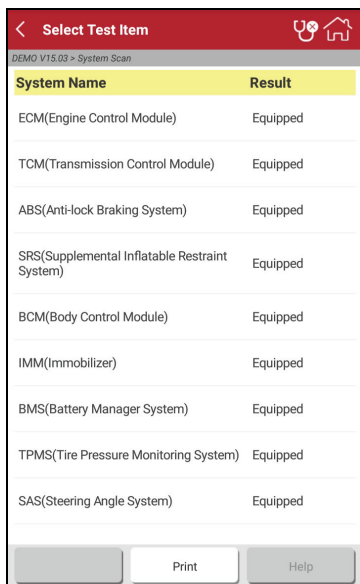

The screenshot shows a mobile application interface titled "Select Test Item". At the top, there is a red header bar with a back arrow, the title "Select Test Item", and two icons (a person and a house). Below the header, the text "DEMO V15.03 - System Scan" is displayed. The main content is a table with two columns: "System Name" and "Result". The table lists various vehicle systems, all of which are marked as "Equipped". At the bottom of the screen, there are three buttons: a grey "Print" button and a grey "Help" button.

System Name	Result
ECM(Engine Control Module)	Equipped
TCM(Transmission Control Module)	Equipped
ABS(Anti-lock Braking System)	Equipped
SRS(Supplemental Inflatable Restraint System)	Equipped
BCM(Body Control Module)	Equipped
IMM(Immobilizer)	Equipped
BMS(Battery Manager System)	Equipped
TPMS(Tire Pressure Monitoring System)	Equipped
SAS(Steering Angle System)	Equipped

Fig. 4-19

Tap the desired system to advance to the test function selection page. For detailed operations on test function, please refer to Chapter 4.5.3.

4.5.3 System Selection

This option allows you manually select the test system and function step by step. In Fig. 4-15, tap “System Selection”, the screen displays as follows:

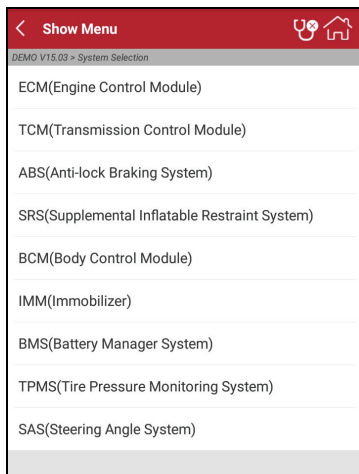

Fig. 4-20

Swipe the screen from the bottom to view the vehicle system on the next page. Tap the desired system (take “ECM” for example) to jump to the test function page.

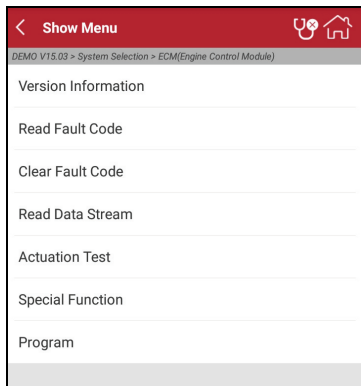

Fig. 4-21

Note: Different vehicle has different diagnostic menus.

A. Version Information

This function is used to read the version information of system mode, vehicle VIN, software and ECU.

B. Read Fault Code

This function displays the detailed information of DTC records retrieved from the vehicle's control system.

*Note: Retrieving and using DTCs for troubleshooting vehicle operation is only one part of an overall diagnostic strategy. Never replace a part based only on the DTC definition. Each DTC has a set of testing procedures, instructions and flow charts that must be followed to confirm the location of the problem. This information can be found in the vehicle's service manual.

In Fig. 4-21, tap "Read Fault Code", the screen will display the diagnostic result.

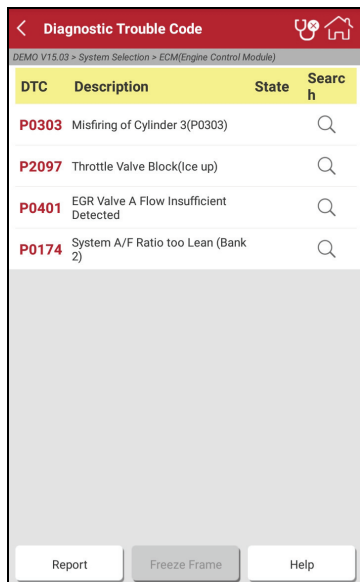

Fig. 4-22

On-screen Buttons:

Freeze Frame: When an emission-related fault occurs, certain vehicle conditions are recorded by the on-board computer. This information is referred to as freeze frame data. Freeze frame data includes a snapshot of critical parameter values at the time the DTC is set.

Help: Tap to view the help information.

🔍: Tap it to search for more information about the current DTC online.

Report: To save the current data in text format. All reports are saved under the tab “Diagnostic Report” in “My Report” from “Personal Center” menu. For details on report operations, please refer to Chapter 9.1 “My Report”.

C. Clear Fault Code

After reading the retrieved codes from the vehicle and certain repairs have been carried out, you can use this function to erase the codes from the vehicle. Before

performing this function, please be sure the vehicle's ignition key is in the ON position with the engine off.

In Fig. 4-21, tap "Clear Fault Code", a confirmation dialog box pops up on the screen. Tap "Yes" and the system will automatically delete the currently existing trouble code.

*Note: The trouble code will not disappear until the trouble was completely cleared.

D. Read Data Stream

This option lets you view and capture (record) real-time Live Data. This data including current operating status for parameters and/or sensor information can provide insight on overall vehicle performance. It can also be used to guide vehicle repair.

*Notes: If you must drive the vehicle in order to perform a troubleshooting procedure, ALWAYS have a second person help you. Trying to drive and operate the diagnostic tool at the same time is dangerous, and could cause a serious traffic accident.

In Fig. 4-21, tap "Read Data Stream", the system will display data stream items.

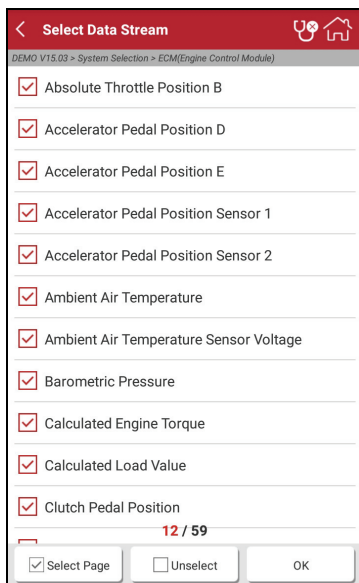

Fig. 4-23

On-screen Buttons:

Select All: Tap it to select all items of the current page. To select certain data stream item, just check the box before the item name.

Unselect: Tap it to deselect all data stream items.

OK: Tap it to confirm and jump to the next step.

After selecting the desired items, tap “OK” to enter the data stream reading screen.

Name	Value	Standard	Unit
Absolute Throttle Position B	12.94	0 - 100	%
Accelerator Pedal Position D	15.69	0 - 100	%
Accelerator Pedal Position E	15.69	0 - 100	%
Accelerator Pedal Position Sensor 1	0.9	0 - 5	V
Accelerator Pedal Position Sensor 2	0.46	0 - 5	V
Ambient Air Temperature	21	-40 - 215	degree C
Ambient Air Temperature Sensor Voltage	1.75	0 - 5	V
Barometric Pressure	99.5	0 - 117.2	KPa
Calculated Engine Torque	-6	-3276.8 - 3276.8	Nm

Fig. 4-24

Notes:

1. The real time (Live Data) vehicle operating information (values/status) that the on-board computer supplies to the tool for each sensor, actuator, switch, etc. is called Parameter Identification Data (PID).
2. If the value of the data stream item is out of the range of the standard (reference)

value, the whole line will display in red. If it complies with the reference value, it displays in blue (normal mode).

- The indicator 1/X shown on the bottom of the screen stands for the current page/total page number. Swipe the screen from the right/left to advance/return to the next/previous page.

There are 3 types of display modes available for data viewing, allowing you to view various types of parameters in the most suitable way.

- ✓ Value – this is the default mode which displays the parameters in texts and shows in list format.
- ✓ Graph – displays the parameters in waveform graphs.
- ✓ Combine – this option is mostly used in graph merge status for data comparison. In this case, different items are marked in different colors.

On-screen Buttons:

Graph: Tap it to view the waveform.

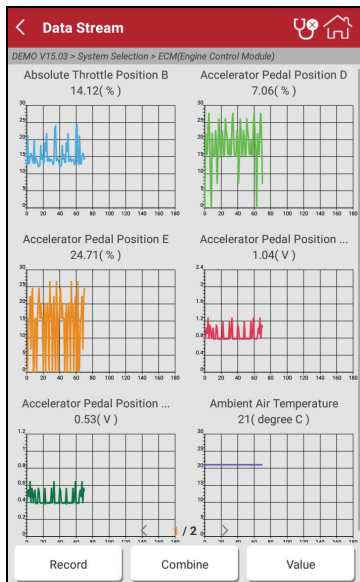

Fig. 4-25

Combine: This option is mostly used in graph merge status for data comparison. In this case, different items are marked in different colors (maximum 4 items can be displayed on the same screen simultaneously). If the graph is more than one page, swipe the screen from the left to jump to the next page.

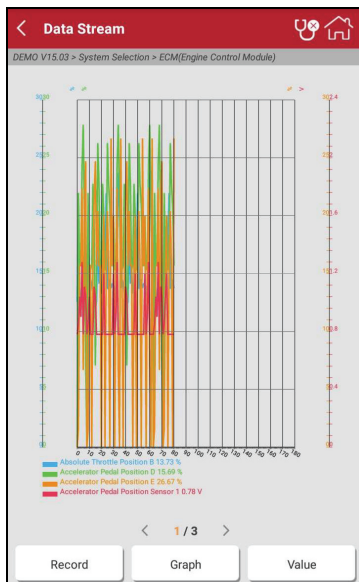

Fig. 4-26

Report: To save the current data in text format. All reports are saved under the tab “Diagnostic Report” in “My Report” from “Personal Center” menu. For details on report operations, please refer to Chapter 9.1 “My Report”.

Record: Tap to start recording diagnostic data for future playback and analysis. The saved file follows the naming rule: It begins with vehicle type, and then the record starting time and ends with .x431 (To differentiate between files, please configure the accurate system time). The file is stored in “My Report” under “Personal Center” menu.

The screenshot shows the 'Data Stream' screen of the X-431 PROS MINI V3.0. At the top, there is a red header with a back arrow, the text 'Data Stream', and icons for user profile and home. Below the header, the text 'DEMO V15.03 > System Selection > ECM (Engine Control Module)' is displayed. The main content is a table with the following data:

Name	Value	Standard	Unit
Absolute Throttle Position B	16.08	0 - 100	%
Accelerator Pedal Position D	27.84	0 - 100	%
Accelerator Pedal Position E	6.67	0 - 100	%
Accelerator Pedal Position Sensor 1	0.78	0 - 5	V
Accelerator Pedal Position Sensor 2	0.39	0 - 5	V
Ambient Air Temperature	21	-40 - 215	degree C
Ambient Air Temperature Sensor Voltage	1.74	0 - 5	V
Barometric Pressure	99.5	0 - 117.2	KPa
Calculated Engine	171	-3276.8 -	Nm

At the bottom of the table, there is a 'Recording' indicator with a play button icon, a progress bar, and a timer showing '00:01'. Below the table, there are six buttons: 'Record', 'Combine', 'Graph', 'Help', and 'Report'.

Fig. 4-27

Help: Tap to view the help information.

E. Actuation Test

This option is used to access vehicle-specific subsystem and component tests. Available test vary by vehicle manufacturer, year, and model.

During the actuation test, the handset outputs commands to the ECU in order to drive the actuators, and then determines the integrity of the system or parts by reading the ECU data, or by monitoring the operation of the actuators, such as switching a injector between two operating states.

In Fig. 4-21, tap "Actuation Test". Simply follow the on-screen instructions and make appropriate selections to complete the test. Each time when an operation is successfully executed, "Completed" displays.

5 Special (Reset) Function

In addition to amazing & powerful diagnostic function, the tool also features various service functions. The most commonly performed service functions contain:

- Oil Reset Service
- Electronic Parking Brake Reset
- Steering Angle Calibration
- ABS Bleeding
- TPMS (Tire Pressure Monitor System) Reset
- Gear Learning
- IMMO Service
- Injector Coding
- Battery Maintenance System
- Diesel Particulate Filter (DPF) Regeneration
- Electronic Throttle Position Reset

There are two methods to reset service lamp: Manual reset or Auto reset. Auto reset follows the principle of sending command from the tool to vehicle's ECU to do resetting. While using manual reset, users just follow the on-screen instructions to select appropriate execution options, enter correct data or values, and perform necessary actions, the system will guide you through the complete performance for various service operations.

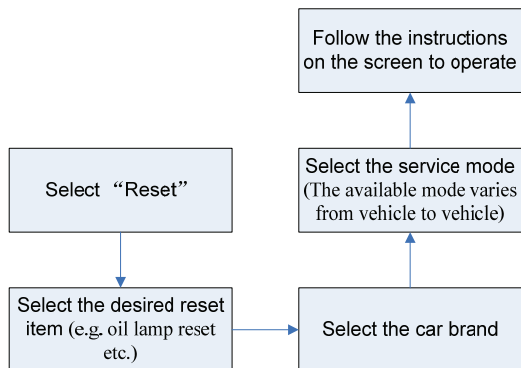

Fig. 5-1

5.1 Oil Reset Service

This function allows you to perform reset for the engine oil life system, which calculates an optimal oil life change interval depending on the vehicle driving conditions and climate.

This function can be performed in the following cases:

1. If the service lamp is on, you must provide service for the car. After service, you need to reset the driving mileage or driving time so that the service lamp turns off and the system enables the new service cycle.
2. After changing engine oil or electric appliances that monitor oil life, you need to reset the service lamp.

5.2 Electronic Parking Brake Reset

1. If the brake pad wears the brake pad sense line, the brake pad sense line sends a signal sense line to the on-board computer to replace the brake pad. After replacing the brake pad, you must reset the brake pad. Otherwise, the car alarms.
2. Reset must be performed in the following cases:
 - a) The brake pad and brake pad wear sensor are replaced.
 - b) The brake pad indicator lamp is on.
 - c) The brake pad sensor circuit is short, which is recovered.
 - d) The servo motor is replaced.

5.3 Steering Angle Calibration

To reset the steering angle, first find the relative zero point position for the car to drive in straight line. Taking this position as reference, the ECU can calculate the accurate angle for left and right steering.

After replacing the steering angle position sensor, replacing steering mechanical parts (such as steering gearbox, steering column, end tie rod, steering knuckle), performing four-wheel alignment, or recovering car body, you must reset the steering angle.

5.4 ABS Bleeding

This function allows you to perform various bi-directional tests to check the operating conditions of Anti-lock Braking System (ABS).

1. When the ABS contains air, the ABS bleeding function must be performed to bleed the brake system to restore ABS brake sensitivity.
2. If the ABS computer, ABS pump, brake master cylinder, brake cylinder, brake line, or brake fluid is replaced, the ABS bleeding function must be performed to bleed the ABS.

5.5 Tire Pressure Monitor System Reset

This function allows you to quickly look up the tire sensor IDs from the vehicle's ECU, as well as to perform TPMS replacement and sensor test.

1. After the tire pressure MIL turns on and maintenance is performed, the tire pressure resetting function must be performed to reset tire pressure and turn off the tire pressure MIL.
2. Tire pressure resetting must be performed after maintenance is performed in the following cases: tire pressure is too low, tire leaks, tire pressure monitoring device is replaced or installed, tire is replaced, tire pressure sensor is damaged, and tire is replaced for the car with tire pressure monitoring function.

5.6 Gear Learning

The crankshaft position sensor learns crankshaft tooth machining tolerance and saves to the computer to more accurately diagnose engine misfires. If tooth learning is not performed for a car equipped with Delphi engine, the MIL turns on

after the engine is started. The diagnostic device detects the DTC P1336 'tooth not learned'. In this case, you must use the diagnostic device to perform tooth learning for the car. After tooth learning is successful, the MIL turns off.

After the engine ECU, crankshaft position sensor, or crankshaft flywheel is replaced, or the DTC 'tooth not learned' is present, tooth learning must be performed.

5.7 IMMO Service

An immobilizer is an anti-theft mechanism that prevents a vehicle's engine from starting unless the correct ignition key or other device is present. Most new vehicles have an immobilizer as standard equipment. An important advantage of this system is that it doesn't require the car owner to activate it since it operates automatically. An immobilizer is considered as providing much more effective anti-theft protection than an audible alarm alone.

As an anti-theft device, an immobilizer disables one of the systems needed to start a car's engine, usually the ignition or the fuel supply. This is accomplished by radio frequency identification between a transponder in the ignition key and a device called a radio frequency reader in the steering column. When the key is placed in the ignition, the transponder sends a signal with a unique identification code to the reader, which relays it to a receiver in the vehicle's computer control module. If the code is correct, the computer allows the fuel supply and ignition systems to operate and start the car. If the code is incorrect or absent, the computer disables the system, and the car will be unable to start until the correct key is placed in the ignition.

To prevent the car being used by unauthorized keys, the anti-theft key matching function must be performed so that the immobilizer control system on the car identifies and authorizes remote control keys to normally use the car.

When the ignition switch key, ignition switch, combined instrument panel, ECU, BCM, or remote control battery is replaced, anti-theft key matching must be performed.

5.8 Injector Coding

Write injector actual code or rewrite code in the ECU to the injector code of the corresponding cylinder so as to more accurately control or correct cylinder injection quantity.

After the ECU or injector is replaced, injector code of each cylinder must be confirmed or re-coded so that the cylinder can better identify injectors to accurately control fuel injection.

5.9 Battery Maintenance System Reset

This function enables you to perform a resetting operation on the monitoring unit of vehicle battery, in which the original low battery fault information will be cleared and battery matching will be done.

Battery matching must be performed in the following cases:

- a) Main battery is replaced. Battery matching must be performed to clear original low battery information and prevent the related control module from detecting false information. If the related control module detects false information, it will invalidate some electric auxiliary functions, such as automatic start & stop function, sunroof without one-key trigger function, power window without automatic function.
- b) Battery monitoring sensor. Battery matching is performed to re-match the control module and motoring sensor to detect battery power usage more accurately, which can avoid an error message displaying on the instrument panel.

5.10 Diesel Particulate Filter (DPF) Regeneration

DPF regeneration is used to clear PM (Particulate Matter) from the DPF filter through continuous combustion oxidation mode (such as high temperature heating combustion, fuel additive or catalyst reduce PM ignition combustion) to stabilize the filter performance.

DPF regeneration may be performed in the following cases:

- a) The exhaust back pressure sensor is replaced.
- b) The PM trap is removed or replaced.
- c) The fuel additive nozzle is removed or replaced.
- d) The catalytic oxidizer is removed or replaced.
- e) The DPF regeneration MIL is on and maintenance is performed.
- f) The DPF regeneration control module is replaced.

5.11 Electronic Throttle Position Reset

This function enables you to make initial settings to throttle actuators and returns the “learned” values stored on ECU to the default state. Doing so can accurately control the actions of regulating throttle (or idle engine) to adjust the amount of air intake.

6 Remote Diagnosis

This option aims to help repair shops or technicians launch instant messaging and remote diagnosis, making the repair job getting fixed faster.

Tap “Remote Diagnosis” to enter, the screen appears blank by default.

6.1 Interface layout

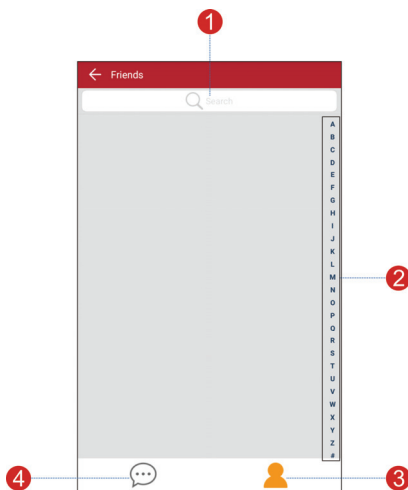

Fig. 6-1

1	Search bar	Directly input the username of the partner to start searching, and then tap the desired one to add it into your friend list.
2	Alphabetic order list	The name of friends is sorted by alphabetic order. Tap the desired letter to quickly locate it.
3	Contact tab	Tap to enter the friend list.
4	Message tab	Once an incoming message reaches, a red dot will appear on the upper right corner of the tab.

6.2 Add friends

Tap “Contact” to enter the contact page. By default it appears blank.

In the search bar, input the partner’s username and tap “Search” button next to the search bar to starts searching from Launch’s golo business database.

The partner must be the users who have registered their Launch’s diagnostic tools. They may be the following:

- Workshop
- Technician
- golo users

Once the result matches the keyword, a screen similar to the following will appear:

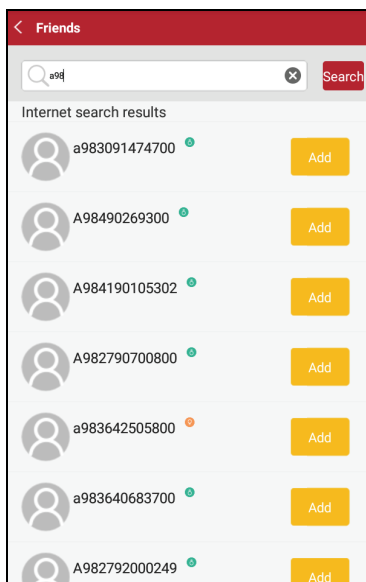

Fig. 6-2

Tap “Add”, a dialog box pops up:

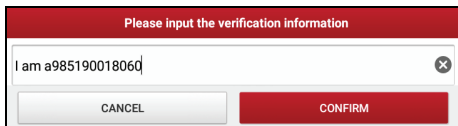

Fig. 6-3

Tap "CONFIRM" to send your request.

Once the partner receives the request, a beep will sound. Tap the "Message" tab:

- Once the partner agreed your request, he/she will automatically be listed in the Contact tab.
- If a technician sent you a friend request, you can tap "Agree" to confirm and his/her name will appear in the friend list (Contact). Or tap "Ignore" to ignore this request.

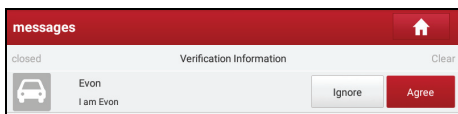

Fig. 6-4

6.3 Start Instant Messaging

*Note: The I/M (Instant Messaging) function is open to all users who had Launch's diagnostic tool equipped with this module.

After adding your friends, tap the desired one's photo to enter a screen similar to the following:

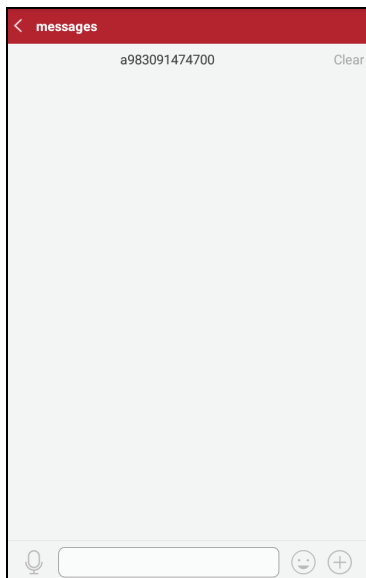





Fig. 6-5

Tap the input field and use the on-screen keyboard to enter the text message, and then tap “Send” to send it.

Tap  to send the voice message.

Tap  to send the emoji.

Tap  to call out more function options.

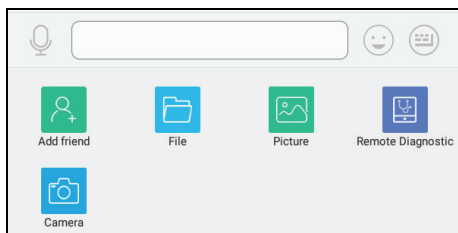

Fig. 6-6

Add Friend: It only appears if the user does not add the partner into the Contacts list.

File: Choose diagnostic reports or local files to send.

Picture: Choose screenshots or pictures to send.

Remote Diagnostic: To start a remote diagnostic session. For details, refer to Chapter 6.4.

Camera: Open camera to take pictures.

Tap “Clear” to delete all the partner’s dialog logs.

6.4 Launch Remote Diagnosis (Device-To-Device)

The tool is allowed to initiate remote diagnosis with other diagnostic tools (including but not limited to the X-431 PROS MINI V3.0) of Launch family, which are equipped with this module.

* Note: Before performing this operation, please make sure the following no matter which side sends the remote request:

- Turn on the vehicle power supply.
- Throttle should be in a closed position.
- The tool should be properly connected to the vehicle’s DLC and a successful communication is required.

In Fig. 6-6, tap “Remote Diagnostic”, a pull-down menu including the following options appears:

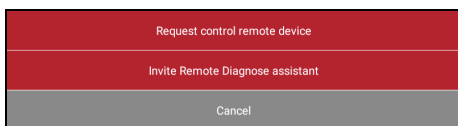

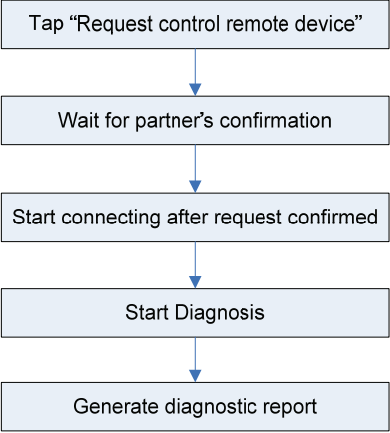



Fig. 6-7

These options are defined as follows:

Actions	Results
Request control remote device	Request to control the partner’s device remotely to help him diagnose the vehicle. *Notes:

	<ul style="list-style-type: none"> • Remote diagnosis has the same diagnostic steps as manual diagnosis. • In process of remote diagnosis, tap the  button to send a voice message. • Once vehicle diagnosis is complete, a report will be created. Input your comments on this report, and then tap “Send Report” to send it to the partner.  <pre> graph TD A[Tap "Request control remote device"] --> B[Wait for partner's confirmation] B --> C[Start connecting after request confirmed] C --> D[Start Diagnosis] D --> E[Generate diagnostic report] </pre>
Invite remote diagnostic assistant	<p>If you need support, just use this option to invite a technician to perform a remote control on your tool.</p> <p>*Notes:</p> <ul style="list-style-type: none"> • Remote diagnosis has the same diagnostic steps as manual diagnosis. • In process of remote diagnosis, tap the  button to send voice message. • Once you received the report from the partner, tap “View Report” to view details. All diagnostic reports are saved under the “Remote Diagnostic Report” tab of “My Report” in “Personal Center”.

	<pre>graph TD; A[Tap "Invite remote diagnostic assistant"] --> B[Choose the desired diagnostic software]; B --> C[Wait for partner's confirmation]; C --> D[Start connecting after request confirmed]; D --> E[Start Diagnosis]; E --> F[Generate diagnostic report];</pre>
Cancel	To cancel this operation.

7 Software Update

This module allows you to update the diagnostic software & App and set frequently used software.

If you did not download the software in process of product registration or a pop-up message prompting you that some new software can be updated, you may use this option to download it or keep it synchronized with the latest version.

7.1 Update Diagnostic Software & APP

Tap “Software Update” on the Home screen to enter the update center.

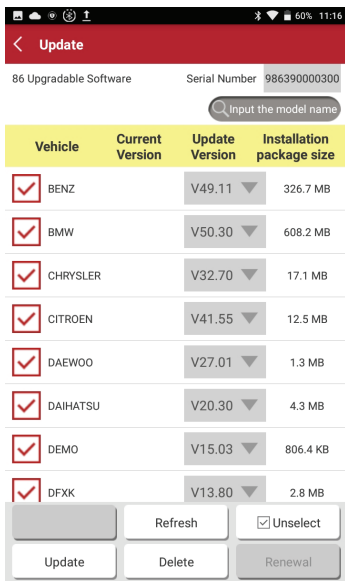

Fig. 7-1

By default, all diagnostic software is selected. To deselect certain software, tap “Unselect”, and then check the box next to vehicle model (or tap **Input the model name** to input the specified model name for selection quickly). Tap “Update” to start downloading. It may take several minutes to finish it,

please be patient to wait. To pause downloading, tap “Stop”. To resume it, tap “Continue”. If network connection failure occurs, tap “Retry” to try again.

Once download is finished, the software packages will be installed automatically.

7.2 Renew Subscription

If the software subscription is due or expires, the system will prompt you to renew your subscription and a “Renew” button will appear on the bottom of the update page.

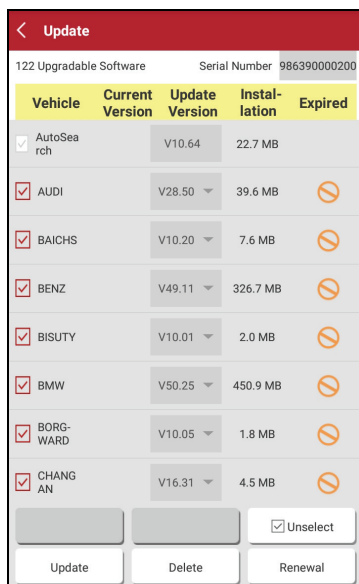

Fig. 7-2

Tap “Renewal” to navigate to the payment screen.

There are two ways available for you to make payment: PayPal and Subscription Renewal Card (*need to buy it from the local dealer where you purchased the tool).

A. Using PayPal

1. Tap “Renewal” on the update page to navigate to the renewal type selection screen.
2. Select “PayPal”, and then follow the on-screen instructions to finish the

transaction.

3. After payment, go to update center to update the diagnostic software.

B. Using Subscription Renewal Card

1. Tap “Renewal” to navigate to the renewal type selection screen.

2. Select “Subscription Renewal Card”.

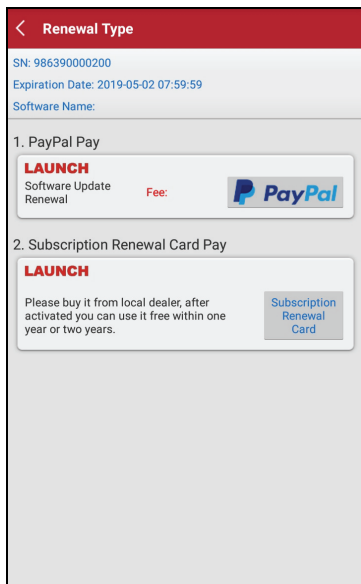

Fig. 7-3

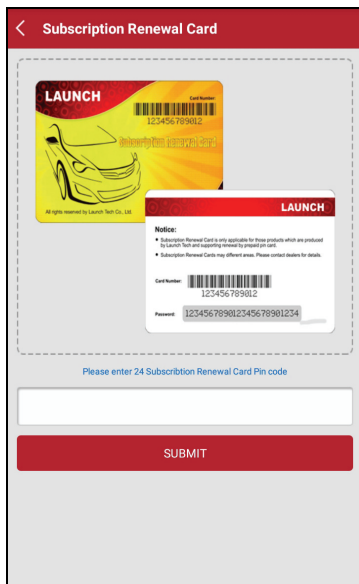

Fig. 7-4

3. Input the 24-digit pin code of Subscription Renewal Card and then tap “Submit” to finish the renewal.

4. Go to update center to update the diagnostic software.

8 Maintenance Help

This option provides abundant repair case and automotive technology handbook for your reference.

It mainly includes the following modules: Training video, operation skills, product manual and FAQ etc.

9 Personal Center

This function allows users to manage your personal information, configure system settings and feedback your vehicle issues or diagnostic reports to us for analysis.

9.1 My report

This option is used to view the diagnostic report generated in process of vehicle diagnosis. Additionally, delete, share operations are also supported.

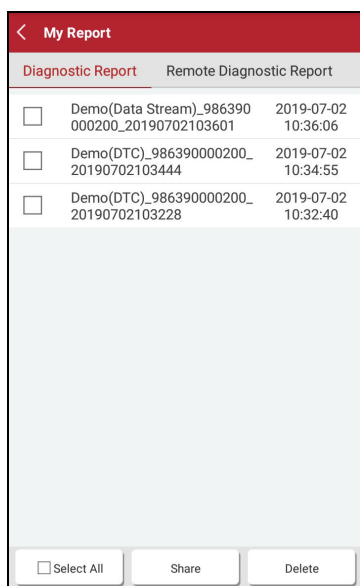

Fig. 9-1

Tap "My Report", there are total 3 options available.

If user records the running parameters while reading data stream, it will be saved as .x431 file and appear under **Diagnostic Record** tab.

Remote Diagnostic Report lists all records generated in process of remote diagnosis.

In case the DTC result is saved on Read Trouble Code page, the files will be

listed under **Diagnostic Report** tab.

9.2 My connector

This option is used to manage all your activated connectors.

If several VCI devices are activated on this tool, a list of connectors will be displayed on the screen. Once you choose the connector that belongs to other account, you have to log out, and then input the right account to continue.

9.3 Activate connector

It is used to activate your VCI device.

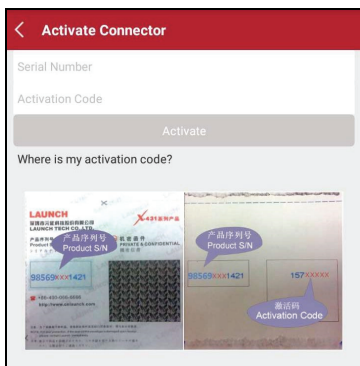

Fig. 9-2

Input the Serial Number and Activation Code, and then tap “Activate” to activate it.

For details on how to obtain Serial Number and Activation Code, tap the link below to get help.

9.4 Firmware fix

Use this item to upgrade and fix diagnostic firmware. During fixing, please do not cut power or switch to other interfaces.

9.5 Feedback

This item allows you to feedback your diagnostic problems to us for analysis and troubleshooting.

9.6 My order

This item allows you to check all paid and unpaid orders.

9.7 Inquire subscription renewal card status

Use this item to inquire the expiry status of the subscription renewal card of diagnostic software.

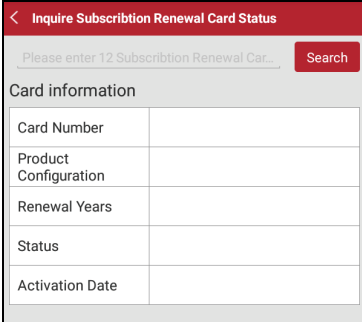

Card information	
Card Number	
Product Configuration	
Renewal Years	
Status	
Activation Date	

Fig. 9-3

Input the 12-digit subscription renewal card number and tap “Search” to check the result.

9.8 Profile

Use this item to view and configure personal information.

9.9 Change password

This item allows you to modify your login password.

9.10 Settings

It enables you to make some application settings and view software version information etc.

9.10.1 Units of measurement

It is designed to set the measurement unit. Metric System and English System are available.

9.10.2 Print information

This option lets you define your print information. It mainly includes Workshop, Address, Telephone, Fax and License Plate.

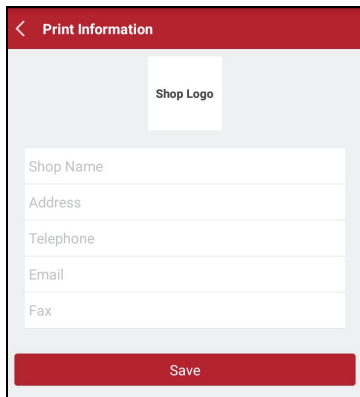

The screenshot shows a mobile application screen titled "Print Information". At the top left is a back arrow icon. Below the title is a "Shop Logo" placeholder. The main area contains five text input fields labeled "Shop Name", "Address", "Telephone", "Email", and "Fax". At the bottom of the screen is a red button labeled "Save".

Fig. 9-4

After inputting, tap on "Save" to save it. Once you configured the information, it will be automatically generated every time you saved the diagnostic report. All vehicle and workshop information will be appended to the diagnostic report.

9.10.3 Launch printer connection

This option is designed to establish a wireless connection between the tablet and the mini printer (sold separately) while performing printing operations.

Follow the steps below to connect the printer.

1. Tap "Launch Printer Connection".

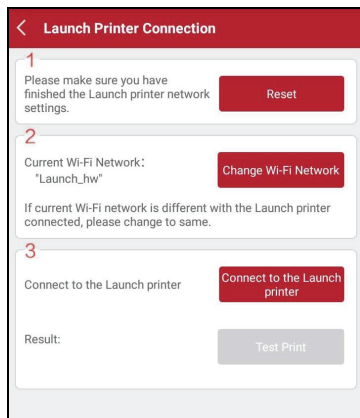

Fig. 9-5

A. If it is the first time you have operated this printer, please proceed the following:

2. For initial use, you are suggested to reset the printer: Press and hold [MODE] & [FEED] for 8 seconds, the following resetting command will be printed out:

at + default = 1

ok

at + reboot = 1

rebooting...

3. Tap "Reset" to configure the mini printer.

Step 1: Connect the printer:

Tap "Scan" to select the desired printer hotspot named with X-431PRINTER-XXXX (XXXX stands for 4 characters), and then tap "Connect" to enter Step 2.

Step 2: Join the printer into LAN:

Tap "Scan" to select the desired local network from the list, and type in the security password (If it is an open network, password is not required), and then tap "Confirm".

3. Once the WLAN network of the printer is connected and the printer is found, tap "Printing test" to test the printing.

Now you can use the printer to print!

If the printer is not found, please reset the printer to default factory settings (refer to Step 2 for details) and check whether the current device and the printer are on the same LAN.

B. If you have configured the printer to the LAN:

2. Tap “Connect to Printer”:

- a). If the local network remains as it is, tap “Test Print” directly to test the printing.
- b). If the local network changes, you have to reset the printer.

9.10.4 About

The software version information and disclaimer are included.

9.10.5 Exit

This option allows you to logout the system.

To logout the current user ID, tap “Exit from current account”.

10 Others

10.1 Synchronization

You can transfer media files and APK between the PC and the tablet.

10.1.1 Connect to PC

1. Use the data cable to connect the tablet to your PC.
2. Swipe from the top, a message "Connected as a media device" appears.

10.1.2 Run on PC

Perform the following steps:

- Locate the new disc.
- Copy the files.

10.1.3 Install an application

Do the following steps:

1. Tap **Settings > Security**, and set the "Unknown sources" to ON, which allows you to install apps from unknown sources.
2. A dialog box appears on the screen, tap "OK" to confirm.
3. Set the tool as "Connected as a media device", and copy the APK file from the PC to the tool.

10.2 Clear Cache

Doing so clears all browsing records and accounts and enables the tablet to run smoothly and quickly.

1. Tap **Settings > Apps**.
2. Tap  and select "Sort by size" to arrange all applications in size order.
3. Tap certain application, then tap "Clear Cache" to release the space these cache files are occupied.

11 FAQ

1. How to save power?

- Please turn off the screen while the tablet keeps idle.
- Set a shorter standby time.
- Decrease the brightness of the screen.
- If WLAN connection is not required, please turn it off.
- Disable GPS function if GPS service is not in use.

2. Communication error with vehicle ECU?

Please confirm:

1. Whether diagnostic connector is correctly connected.
2. Whether ignition switch is ON.
3. If all checks are normal, send vehicle year, make, model and VIN number to us using “Feedback” feature.

3. Failed to enter into vehicle ECU system?

Please confirm:

1. Whether the vehicle is equipped with this system.
2. Whether the VCI dongle is correctly connected.
3. Whether ignition switch is ON.
4. If all checks are normal, send vehicle year, make, model and VIN number to us using “Feedback” feature.

4. How to Activate new VCI device?

Note: Before registration, please make sure the network is properly connected.

- A. If this is the first time using the handset, please refer to “Chapter 4.2.1” in the user manual for product registration.
- B. If you have activated a VCI device before, but bought a new VCI device due to the loss or other reasons, please follow the below steps to activate:
 1. On the Job menu, tap “Personal Center” -> “Activate Connector”.
 2. Input product S/N and activation code, which can be found from the

included password envelope, then tap “Activate”.

3. After activation completed, tap “Personal Center” -> “My Connector” to check if the activated VCI device is displayed in the connector list or not. Multiple VCI devices can be bound to one tool. If you intend to use one of the VCI devices to diagnose or test a vehicle, just switch to the corresponding VCI device.

5. How to do if the system runs slow?

In this case, please do the followings:

> Check all running applications and stop the unnecessary applications (Steps: Settings --> Apps --> Running --> Tap the desired application and then tap “Stop”).

> Check all installed applications, remove the unnecessary applications (Steps: Settings --> Apps --> Downloaded --> Tap the desired application and then tap “Uninstall”).

If all steps mentioned above are finished and the system still works slowly. Please try to close the system and reboot the tablet.

6. How to reset the tablet?

 Resetting may cause data loss. Before doing so, please make sure important data and information has been backed up.

Do the following to reset the tablet:

1. Tap “Settings” --> “Back & Reset”.
2. Tap “Factory data reset”.
3. Tap “Reset tablet”.
4. Tap “Clear all data” to start resetting until the tool automatically reboots.

Warranty

THIS WARRANTY IS EXPRESSLY LIMITED TO PERSONS WHO PURCHASE LAUNCH PRODUCTS FOR PURPOSES OF RESALE OR USE IN THE ORDINARY COURSE OF THE BUYER'S BUSINESS.

LAUNCH electronic product is warranted against defects in materials and workmanship for one year from date of delivery to the user.

This warranty does not cover any part that has been abused, altered, used for a purpose other than for which it was intended, or used in a manner inconsistent with instructions regarding use. The exclusive remedy for any automotive meter found to be defective is repair or replacement, and LAUNCH shall not be liable for any consequential or incidental damages.

Final determination of defects shall be made by LAUNCH in accordance with procedures established by LAUNCH. No agent, employee, or representative of LAUNCH has any authority to bind LAUNCH to any affirmation, representation, or warranty concerning LAUNCH automotive meters, except as stated herein.

Disclaimer

The above warranty is in lieu of any other warranty, expressed or implied, including any warranty of merchantability or fitness for a particular purpose.

Purchase Order

Replaceable and optional parts can be ordered directly from your LAUNCH authorized tool supplier. Your order should include the following information:

Order quantity

Part number

Part name

Customer Service

Any question during the operation, please call 86-755-84528722.

If your unit requires repair service, return it to the manufacturer with a copy of the sales receipt and a note describing the problem. If the unit is determined to be in warranty, it will be repaired or replaced at no charge. If the unit is determined to be out of warranty, it will be repaired for a nominal service charge

plus return freight. Send the unit pre-paid to:

Attn: Customer Service Department

LAUNCH TECH CO., LTD.

Launch Industrial Park,

North of Wuhe Avenue,

Banxuegang, Bantian,

Longgang, Shenzhen, Guangdong

P.R.China, 518129

Launch website: <http://www.cnlaunch.com>

<http://www.x431.com>

<http://www.dbscar.com>

Statement:

LAUNCH reserves the rights to make any change to product designs and specifications without notice. The actual object may differ a little from the descriptions in the manual in physical appearance, color and configuration. We have tried our best to make the descriptions and illustrations in the manual as accurate as possible, and defects are inevitable, if you have any question, please contact local dealer or after-sale service center of LAUNCH, LAUNCH does not bear any responsibility arising from misunderstandings.