

FINLUX

Convactor Heater

Model:FCH-1820 BG

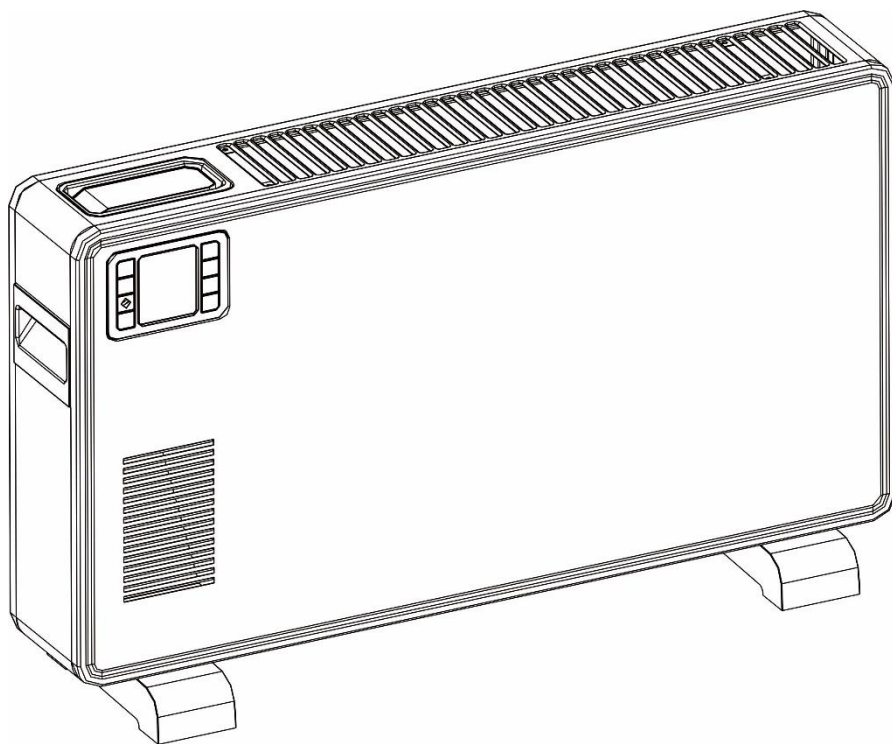

This product is only suitable for well insulated spaces or occasional use.

Instruction Manual

TECHNICAL DATA

Model	FCH-1820 BG	
RATED VOLTAGE	AC220-240V/50/60Hz	
POWER	2000-2300W	

GENERAL DIRECTIONS

1. Remove the packaging and make sure that the appliance is intact. If in doubt, do not use it and contact our Technical Assistance Centre. Packaging materials (plastic bags, polystyrene, staples etc.) must be kept out of the reach of children as they could be hazardous.
Caution:
 - The appliance must only be used by responsible adults;
 - For their own safety, children and persons with reduced mental capacities must not use the appliance unless under the supervision of responsible adults;
2. Before connecting the appliance, check that the appliance rating corresponds to the mains rating.
3. If the power cable is damaged, it must be replaced by the manufacturer or otherwise by a qualified person in order to prevent any risk.
4. This appliance must only be used for the purpose for which it has been manufactured, i.e. for additional electrical heating in rooms. Any other use is considered improper and therefore dangerous. The manufacturer is not responsible for any damage caused by improper, incorrect or unreasonable use.
5. Before cleaning or carrying out maintenance on the appliance, disconnect it from the electrical mains by removing the plug from the electrical outlet or by switching off the system switch.
6. If the appliance is faulty and/or operating incorrectly, switch it off without tampering with it. If the above is disregarded, the safety of the appliance may be compromised.
7. Switch off the appliance and remove the plug from the electrical outlet when not in use.
8. The use of any electrical appliance calls for the awareness of some basic rules, such as:
 - do not use the appliance near sources of water such as baths, showers or swimming pools
 - do not touch the appliance with wet or damp hands or feet
 - do not leave the appliance exposed to atmospheric agents
9. Do not use the appliance in the presence of potentially flammable or explosive liquids or gases.

IMPORTANT

1. In order to avoid overheating, it is advisable to unwind the entire length of the power cord.
2. Check that the electric capacity of the system and the power outlets are adequate for the maximum power stated on the plate. If in doubt, please contact a qualified professional.
3. Do not leave the appliance plugged in when not required. Unplug the appliance from the mains after having switched it off when not in use.
4. Do not obstruct the ventilation or heat dispersion openings.

5. The power cord on this appliance must not be replaced by the user. If the cord is damaged or requires replacement, contact qualified personnel only.
6. Avoid the hot contact, checking that the cord is not placed in front of the hot air outlet grille.
7. Do not use near bathtubs, showers or basins (minimum distance 1 metre).
8. Use in an upright position.
9. Keep the suction grille clean.
10. Do not use the appliance immediately below a fixed power outlet.

WARNING

In order to avoid overheating, do not cover the heater.

CAUTION

1. Some parts of this product can become very hot and cause burns. Particular attention has to be given where children and vulnerable people are present.
2. The heater must not be located immediately below a socket-outlet.
3. Do not use this heater in the immediate surroundings of a bath, a shower or a swimming pool.
4. Cleaning and user maintenance shall not be made by children unless they are older than 8 and supervised.
5. Keep the appliance and its cord out of reach for the children less than 8 years.
6. If the supply cord is damaged, it must be replaced by the manufacturer or its service agent or a similarly qualified person in order to avoid a hazard.
7. Children of less than 3 years should be kept away unless continuously supervised.
8. Children aged from 3 years and less than 8 years shall only switch on/off the appliance which provided that it has been placed or installed in its intended normal operating position, and they have been given supervision or instruction concerning use of the appliance in a safe way and understand the hazards involved.
9. Children aged from 3 years and less than 8 years shall not plug in, regulate and clean the appliance or perform user maintenance.

PRODUCT FEATURES

1. Aluminum shell, high thermal efficiency
2. **heating element**: quick heating with higher energy savings.
3. LCD display function information .
4. Timer from 1 to 24 hours to turn the convector heater on or off at the desired time.
5. Digital display with automatic room temperature display.
6. Free standing with tripod.

FOOT ASSEMBLY

Before using the heater, the feet (supplied separately in the cartoon) , must be fitted to the unit.

These are to be attached to the base of the heater using the 4 self-tapping screws provided, taking care to ensure that they are located correctly in the bottom ends of the heater side moldings.

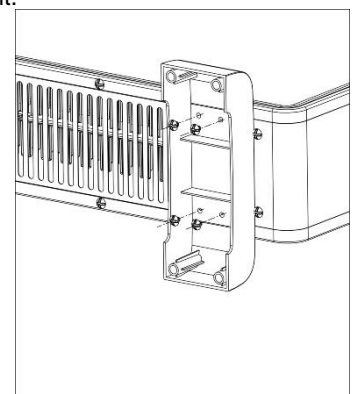

Note: It is normal when the heaters are turned on for the first time or when they are turned on after having been used for a long period of time the heaters may emit some smell and fumes .This will disappear when the heater has been on a short while.

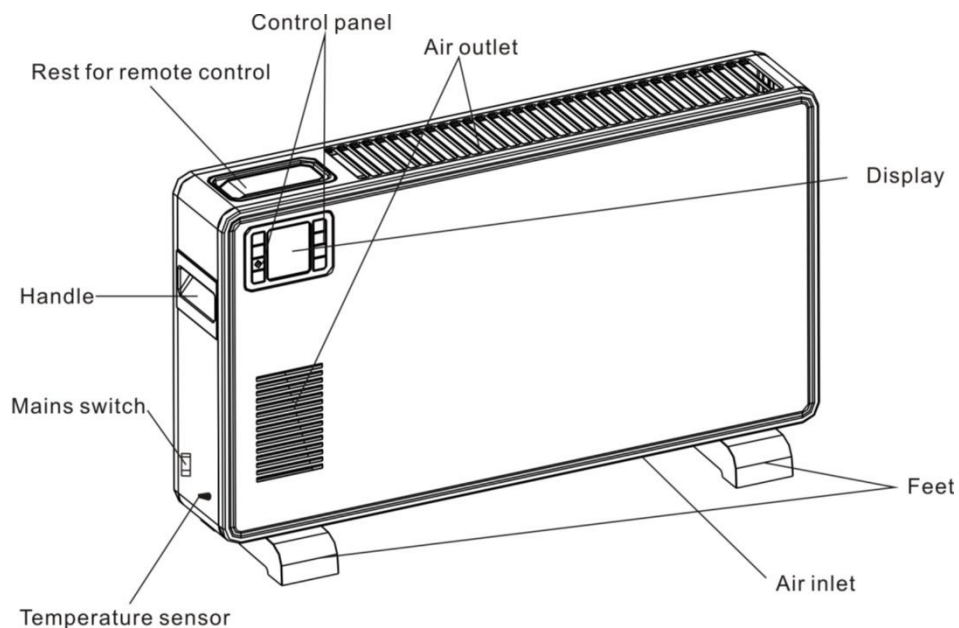

Operation panel function introduction



- | | |
|--|--|
| 1 Selected heating level display | 14 Wi-Fi button |
| 2 "Fan" symbol | 15 Button for selecting the heat setting |
| 3 "Frost protection" symbol | 16 Wi-Fi indicator lamp |
| 4 Selected unit of measurement display | |
| 5 Fan button | |
| 6 Increase temperature | |
| 7 Reduce temperature | |
| 8 Timer button | |

- 9 Running time display
- 10 Set temperature display
- 11 Measured temperature display
- 12 On/Off button
- 13 Infrared receiver for remote control

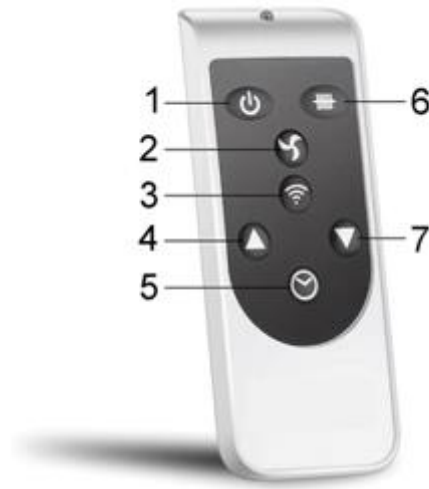

- 1. On/Off button
- 2. Fan button
- 3. Wi-Fi button
- 4. Increase temperature
- 5. Timer button
- 6. Button for selecting the heat setting
- 7. Reduce temperature

Key function introduction

POWER function

Insert the plug in a suitable power socket. After turn on the main switch (on the right side) ,the computer board emits a "click" sound ,the screen displays the current room temperature ,and turn on the panel control switch ,to enter the standby state and display the current room temperature and set temperature at the same time .In the meantime ,other displays are not displayed .

Then press the button for selecting the heat setting ,you can select the 1000/1300/2300W/Anti-frost four modes .When you select the 1000W or 1300W or 2300W .The heater will be heated according to your setting .

Timer and temperature setting

Timer

Press the timer button, each time the time is increased by 1 hour, when the timer time is 24:00, press the timer button, then the function is turned off, when the timer function is set, the timer countdown starts in 5 seconds, and after the timer is over, it enters standby mode;

Temperature

Press the temperature shift key to change the temperature display mode. The default is Celsius degree. Press 1 time, degree to Fahrenheit and 2 times conversions.

Press "+" or "-" key to set the temperature (set temperature must be greater than the current temperature) .

For Celsius, cycle through Internal temperature (room temperature) is displayed every time the appliance is started up. The temperature can be set when the appliance is in stand-by or heating. When the room temperature reaches the set level, the heater stops to work ;When room temperature is 1 degrees over the set temperature, the heater also will stop tor work .The heater will

begin operating again only when temperature decreases 1 degrees with respect to the set temperature. The temperature regulation range is 5°C-37°C.

Mode

Press "4-mode" to regulate 1000W /1300W/2300W/ANTI-FROST temperature power.

FAN

Press the fan to open the key, you can open the fan or turn off the fan (on the screen fan icon is light fan, Figure off the wind organ);

In anti-frost mode: In the standby mode, the room temperature is lower than 5°C, and automatically enters the high-grade (2300W) heating mode. When the room temperature reaches 9°C, the heating is turned off to standby, followed by cycling.

Operating sound

The appliance emits a beep upon each operation setting.

LCD room temperature display: the appliance will stop when the temperature exceeds 1 degrees with respect to the set temperature.

Memory

The appliance can hold the last temperature setting in its memory. This temperature will be shown at each start-up.

CONNECTING THE APPLIANCE TO WIFI

DOWNLOAD THE APP TO YOUR PHONE

Download the "TUYA SMART" app, from your chosen app store, using the QR codes below, or by searching for the app in your chosen store.



IOS



Android

MODE FOR SETUP

The heater has one setup mode, AP (Access Point). The AP connection uses a direct local WiFi connection between your phone and the heater to upload the network details.

When first turned on using the main switch on the right side of the unit, the WiFi will be turned off. To turn on the WiFi, press and hold the Wi-Fi button for 3 seconds. The WiFi indicator will flash quickly to indicate the unit is in AP connection mode.

Please ensure your device is in the correct WiFi connection mode for the connection type you are attempting, the flashing WiFi indicator on your heater will indicate this.

Connection Type	Frequency of Flashes
-----------------	----------------------

AP (Access Point)	Flashes once per second
-------------------	-------------------------

TURNING THE WIFI OFF

To turn the WiFi off, the appliance can be turned off using the main switch on the right side or press and hold the Wi-Fi button for 5 seconds . When the unit is turned back on it will start with the WiFi turned off, until reactivated following the steps above.

REGISTER THE APP

1. Press on the register button at the bottom of the screen.

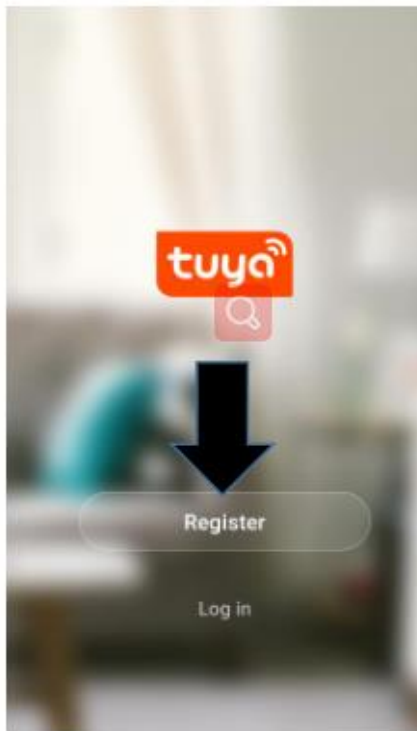

2. Read the Privacy policy and press the Agree Button.

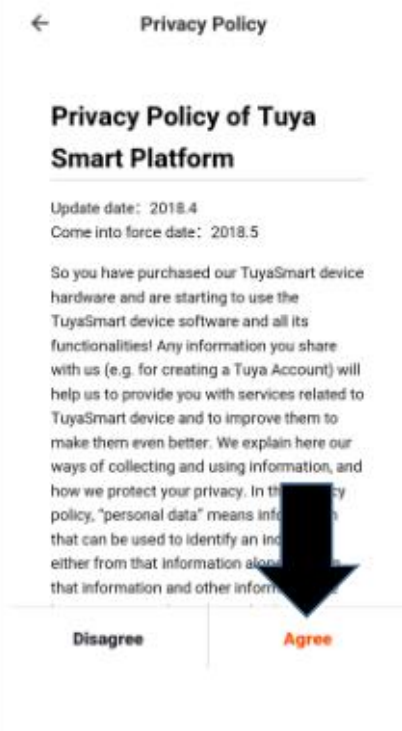

3. Enter your email address or phone number and press continue to register.

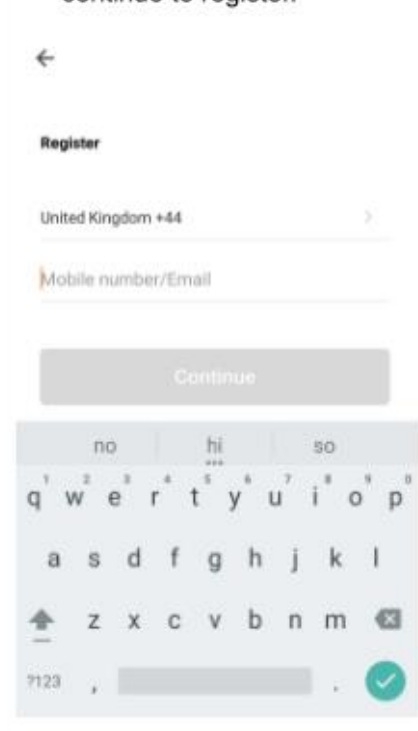

4. A verification code will be sent by the method selected in step 3. Enter the code into the app.



5. Type in the password you would like to create. This needs to be 6-20 characters, with letters and numbers.

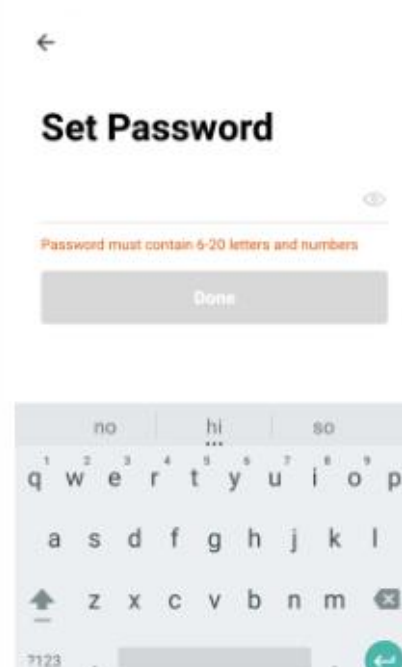

2. The app is now registered. It will automatically log you in following registration.

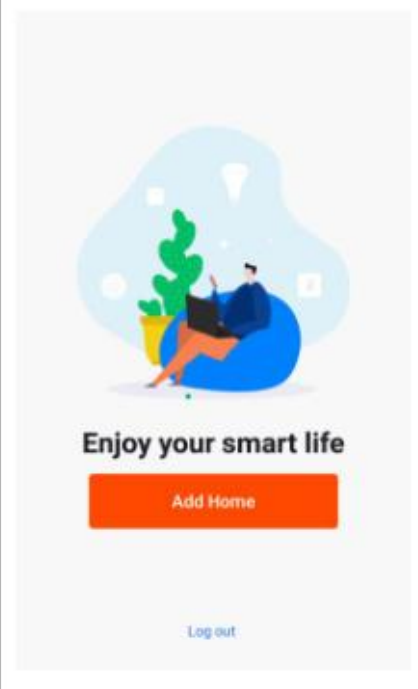

SETTING UP YOUR HOME WITHIN THE APP

TUYA is designed so it can work with a large number of compatible smart devices within your home. It can also be set up to work with multiple devices within different houses as such during the setup process the app requires that different areas are created and named to allow easy management of all your devices. When new devices are added, they are assigned to one of the rooms you have created.



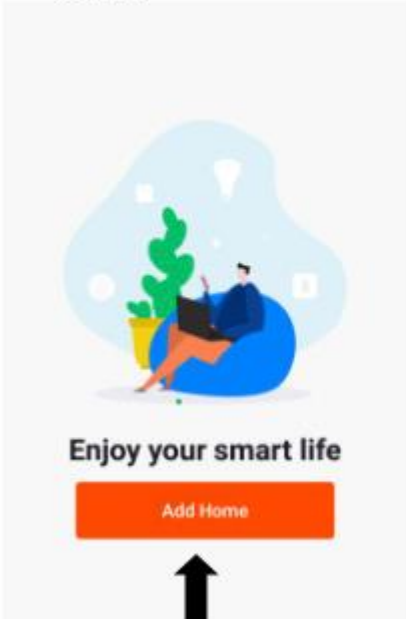
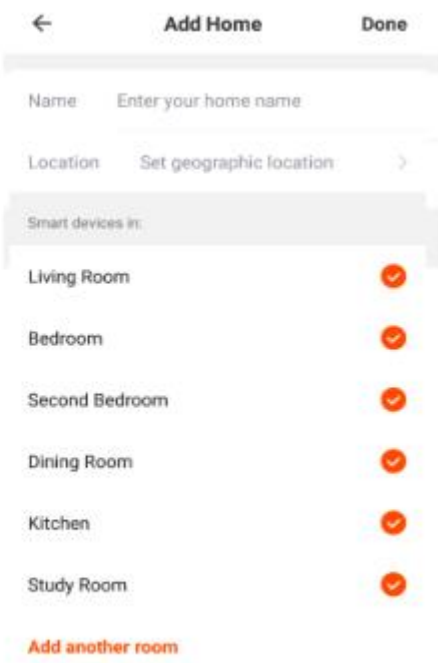

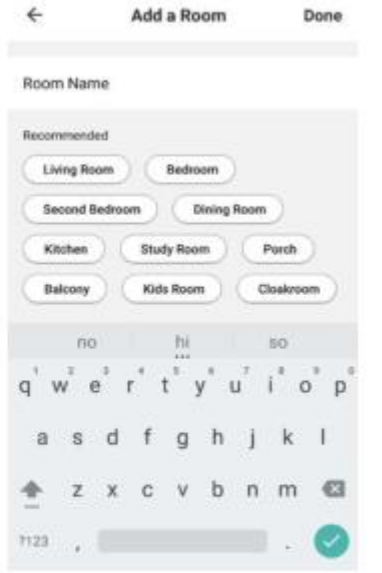

CREATING ROOMS

<p>1. Press on the ADD HOME button.</p> 	<p>3. Type in a name for your home, 4. Press on the location button to select the location of your home. (See SETTING YOUR LOCATION below) 5. New rooms can be added by pressing the ADD ANOTHER ROOM option at the bottom. (See ADD ANOTHER ROOM below) 6. Untick any rooms that are not required on the app. 7. Press DONE in the top right corner.</p>	
--	---	--

<p>SETTING YOUR LOCATION</p> <p>Use your finger to move the orange HOME symbol.</p> <p>When the symbol is in the approximate location of your home, press the confirm button in the top right corner.</p> <p>Location details allows the app to be set up later to respond to weather conditions in your area.</p> 	<p>ADD ANOTHER ROOM</p> <p>Type in the name of the room, and press Done in the top right corner</p> 
---	--

CONNECTING USING APP MODE ALTERNATIVE METHOD

Before initiating the connection, make sure the unit is in standby mode(Power switch ON, but unit turned off), with the WiFi Light Indicator flashing once per second. Also ensure your phone is connected to the WiFi network. (We advise turning mobile data off during setup).

<p>1. Open app and press "+" to add device, or use the add device button</p> 	<p>2. Select the type of device as "Heater" within the Home Appliance tab.</p> 	<p>3. Press on the AP mode button in the top right of the screen.</p>  <p>Power on the device and confirm that indicator light rapidly blinks</p> <p>How to make indicator rapidly blink</p> <p>Confirm indicator rapidly blink</p>
<p>4. Ensure the Ambient Light indicator on the heater is slowly flashing (once per second), then press on the orange button at the bottom of the screen to confirm</p>  <p>Power on the device and confirm that indicator light slowly blinks</p> <p>How to make indicator slowly blink</p> <p>Confirm indicator slowly blink</p>	<p>5. Enter your WiFi password and press confirm.</p>  <p>Cancel</p> <p>Enter Wi-Fi password</p> <p>Wi-Fi: SKYD58D Change network</p> <p>Confirm</p> <p>This app is supported only on 2.4GHz Wi-Fi channels</p>	<p>6. This will then transfer the settings to the heater. Wait for this to complete. If this fails, retry. If still unsuccessful please review the troubleshooting section for further help.</p>  <p>Connecting Now</p> <p>8%</p> <p>Make sure your phone and device are as close to your router as possible.</p> <ul style="list-style-type: none">Searching for DeviceRegistering device to the cloudInitializing your Device
<p>This will then transfer the settings to the heater. Once the connection process has completed, go back to the network settings on your phone to ensure your phone has reconnected to your WiFi router.</p>		

CONTROLLING YOUR APPLIANCE THROUGH THE APP

THE HOME SCREEN

Each device has its own entry on the home screen to allow the user to either quickly turn the unit on or off, or to enter the device screen to make other changes.

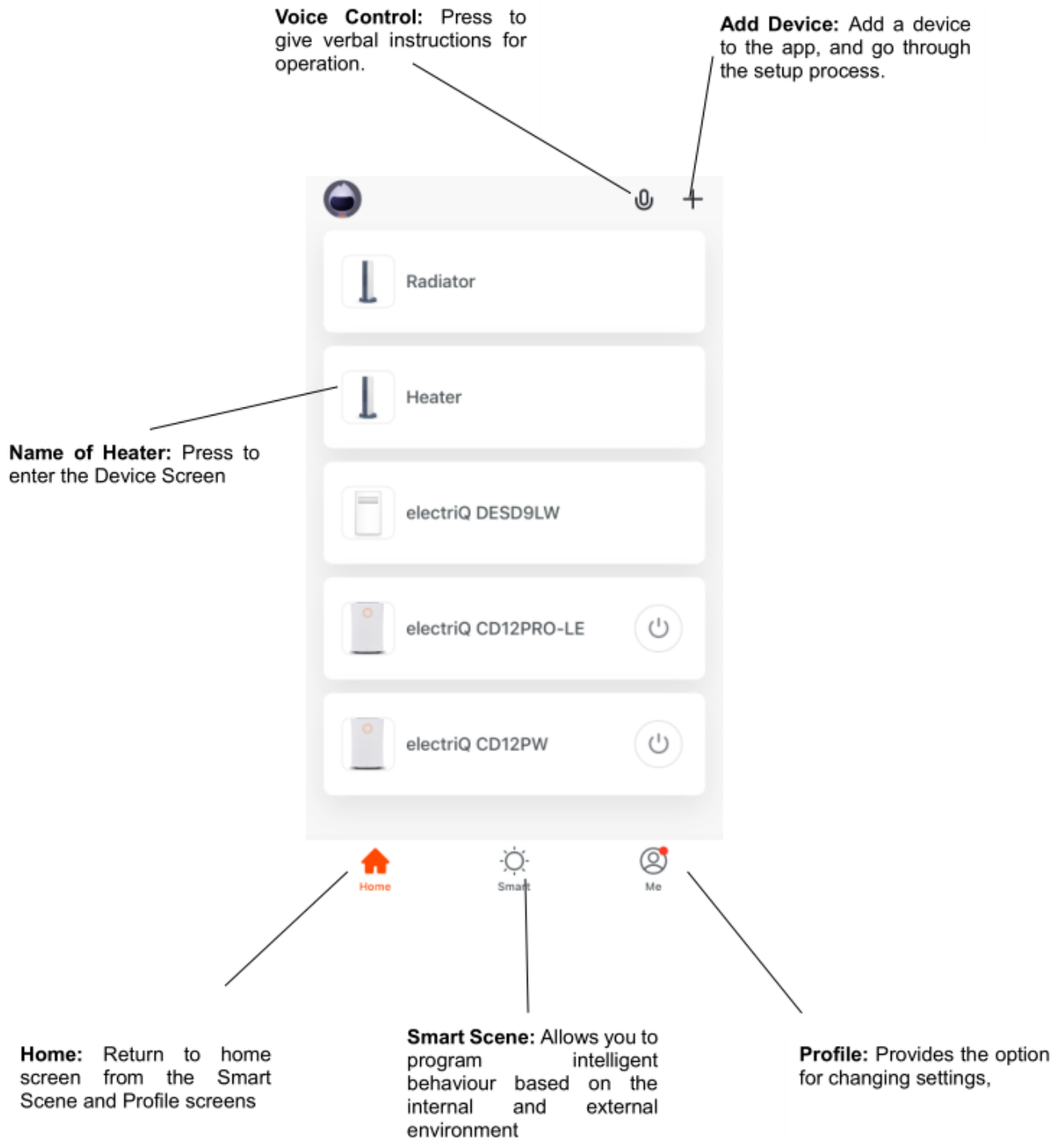

DEVICE SCREEN

The device screen is the main control screen for the heater, providing access to the controls to amend the functions and settings.

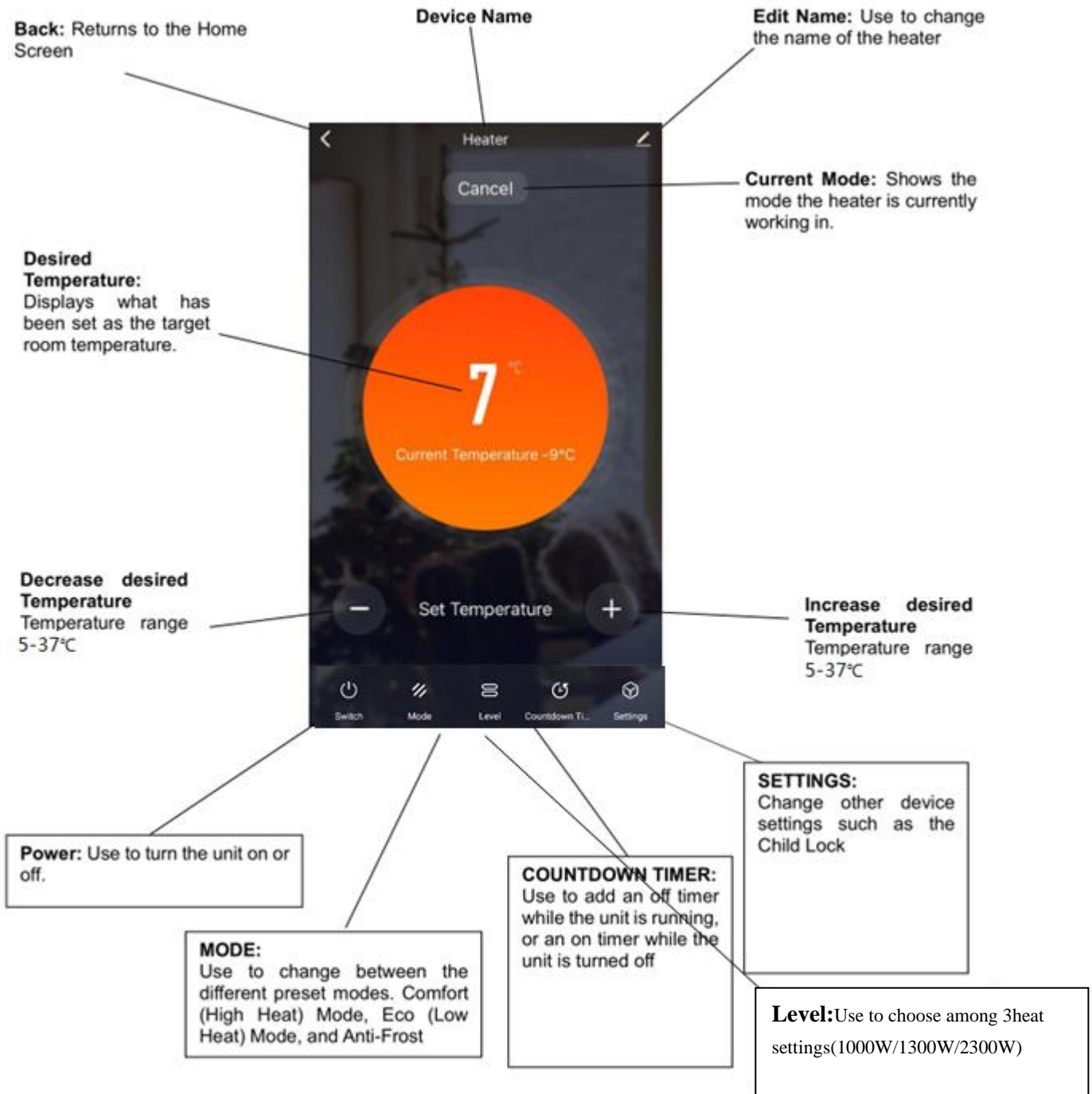

NOTE: Due to continuous development of the app, the layout and available features may be subject to change.



SMART SCENES

Smart Scenes is a powerful tool providing the option to customize the operation of the air heater based both on conditions within the room and outside influences. This gives the user the option of specifying much more intelligent actions. These are split into two categories Scene and Automation.

SCENE



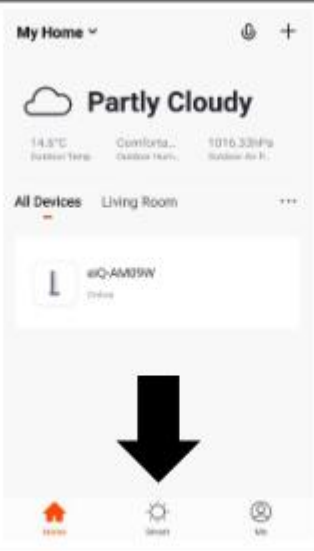

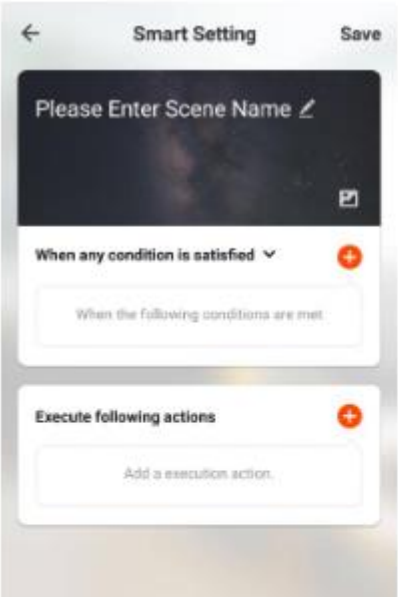
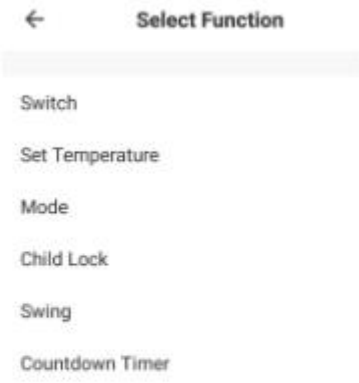
Scene allows for a one-touch button to be added to the Home Screen. The button can be used to change a number of settings in one go and can change all the settings within the unit. A number of scenes can easily be set up, allowing the user to easily change between a number of preset configurations.

Below is an example of how to set up a scene:

<p>1. Press on the Smart tab at the bottom of the Home screen</p> 	<p>2. Press on the Plus in the top right corner or on Add Scenario to add a smart scene.</p> 	
	<p>3. Press the Pen next to "Please Enter Scene Name" to input the name for your Scene Show on Dashboard: Leave this on if you require the scene to be displayed as a button on the Home Screen Press the Red Plus to add the action required. Then select the heater from the list of devices.</p>	<p>4. Chose the function, set the value for the function, and then press the back button in the top right corner, to return to the previous screen.</p> 
<p>6. Once all the functions required have been added, press the Save button in the top right corner to finalize and save your new Scene. It will then be saved to the home screen</p>		

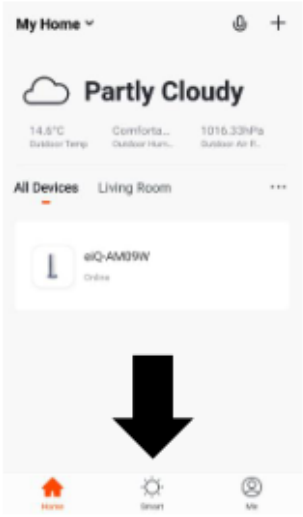
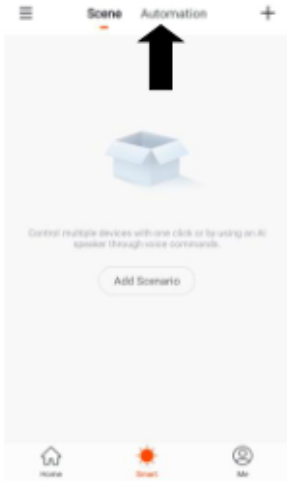
AUTOMATION

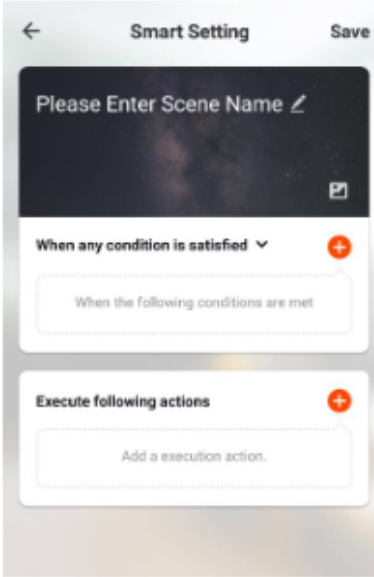
Automation allows an automatic action to be set up for the device. This can be triggered by the Time, and a range of other influences, depending on what other TUYA enabled devices you have on the network.

<p>1. Press on the Scene tab at the bottom of the Home screen</p> 	<p>2. Press on the Automation tab at the top of the screen.</p> 	<p>3. Press on the + at the top of the screen or press on Add Automatic Action</p> 
	<p>4. Setup is very similar to the scene setup on the previous page, and includes an extra section for specifying a trigger for the scene to start. Press the Pen next to "Please Enter Scene Name" to input the name for your Scene Press the Red Plus next to "When any condition is satisfied" to add the trigger Press the Red Plus next to "Execute following actions" to add the action required. Then select the heater from the list of devices.</p>	<p>5. Select the condition when the automation should start. A number of triggers can be combined.</p> 
<p>6. Chose the function, set the value for the function, and then press the back button in the top right corner, to return to the previous screen.</p> 	<p>7. Once all the functions required have been added, press the Save button in the top right corner to finalize and save your new scene.</p> <p>The automation is now set up, it can be turned on and off using the toggle on the home page.</p>	

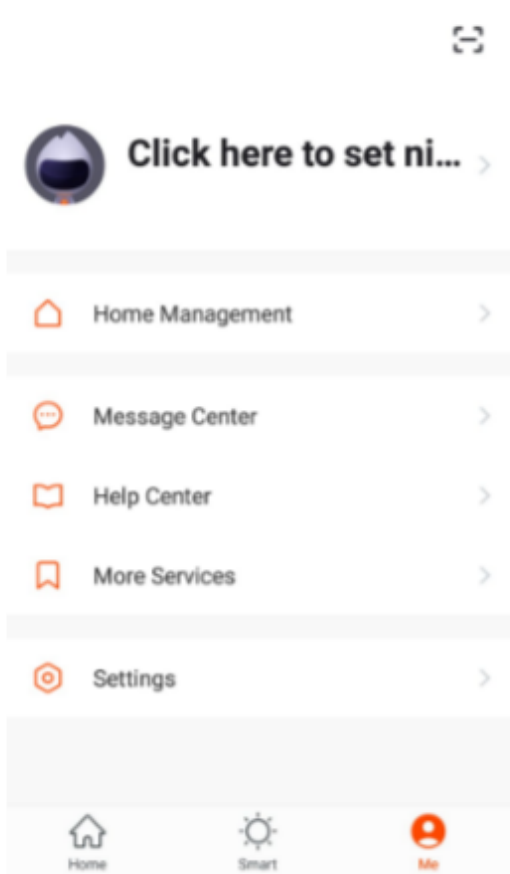

PROFILE TAB

The profile tab gives you the option to edit both your detail, and use the added features of the unit.

HOME MANAGEMENT

Home Management provides options for managing your TUYA account, giving options such as adding a home, adding and removing rooms, and sharing devices with family.

MESSAGE CENTRE

View notifications from devices, if alarms are set up (dependent on device)

HELP CENTRE

Provides assistance using the features provided within the app

MORE SERVICES

This allows the unit to be integrated with your favorite home automation hardware such as Google Home and the Amazon Echo.

CONNECTION TROUBLESHOOTING

1. Check whether the device is powered on and is in the correct WiFi connection mode, if not please refer to the **CHANGING BETWEEN CONNECTION MODES** section.
2. Ensure the WiFi password has been entered into the app correctly (Case sensitive)
3. Check that the phone is connected to the WiFi you are connecting the device to.
4. Ensure the network you are connecting it to is 2.4Ghz (5Ghz WiFi networks are not supported), and that there is a strong WiFi signal to the item.
5. If your router is dual band, ensure that the 2.4ghz network has a different network name (SSID). Further advice on changing router settings will be available from your Internet service provider / Router manufacturer.
6. Check the settings on the router. Encryption should be WPA2-PSK and authorisation type should be set to AES

MAINTENANCE

Before carrying out routine cleaning, switch off the product and disconnect main power. Use a soft, damp cloth only and do not use abrasive substances.

Note: Do not submerge any part of the product in the water.

CONFORMITY WITH DIRECTIVES

This product is CE marked to denote conformity with Directives 2006/95/EC (Low Voltage) and the EMC directive (2004/108/EC), as amended.

Correct Disposal of this product



This marking indicates that this product should not be disposed with other household wastes throughout the EU. To prevent possible harm to the environment or human health from uncontrolled waste disposal, recycle it responsibly to promote the sustainable reuse of material resources. To return your used device, please use the return and collection systems or contact the retailer where the product was purchased. They can take this product for environmental safe recycling.