

SL60 Technical Data Sheet



Modules are used with self-levelling system in tile applications to create raised floors. Allow auto slope correction on surfaces maximum up to 5% gradient.

SL60 Product Features

Raw Material	Polypropylene
Height Range	Adjustable min.42mm – max. 260 mm (Optionally, extra 'extension' can be used to increase the height more than 260mm)
Base Diameter	187 mm
Base Wall Thickness	3 mm
Head Diameter	126 mm
Laying Surface of the Base	302 cm ²
Tab Thickness	2 mm / 3 mm / 4 mm (removable)
Tab Height	10 mm
Slope Correction	% 5
Environmental Impact Assessment	Eco - Friendly
Application Areas	Can be used for all indoor and outdoor areas. Also, on levelled surfaces, epoxy or membrane insulated in areas.
Application	Using any of fixing material is not necessary. Optionally, the modules can be fixed to the application surface using adhesive or screw.

SL60 Technical Drawing

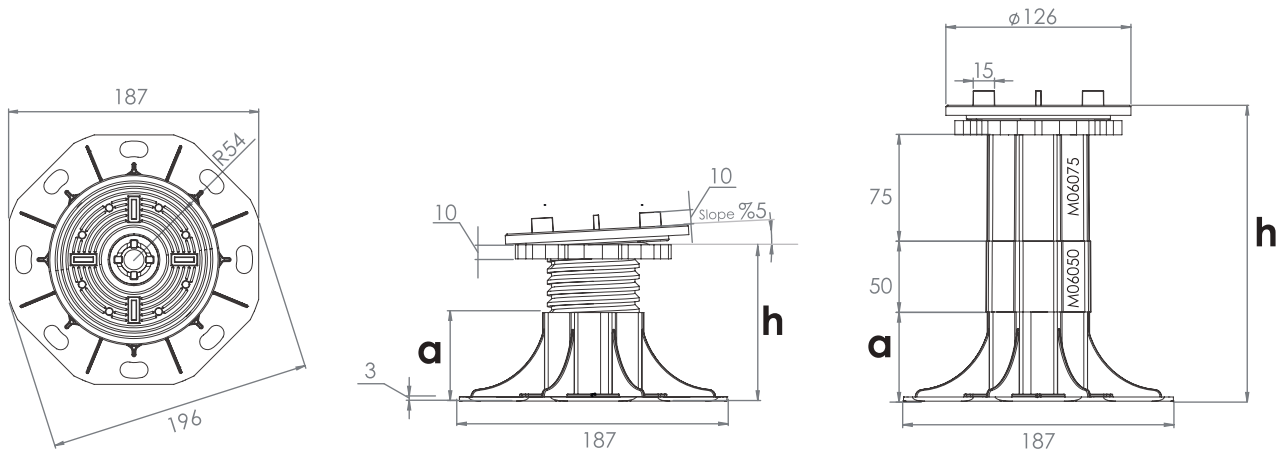

SL60 Dimension & Weight

Model	SL60-01	SL60-02	SL60-03	SL60-04	SL60-05	SL60-06	SL60-07	SL60-08	SL60-09	SL60-10
a	18 mm	27 mm	40 mm	62 mm	40 mm	62 mm	62 mm	62 mm	62 mm	62 mm
h (min. - max)	42-48 mm	48-60 mm	60-85 mm	83-120 mm	112-140 mm	136-165 mm	157-194 mm	185-215 mm	210-235 mm	230-260 mm
Extension	-	-	-	-	M06050	M06050	M06075	M06050	M06050 M06075	M06075
Weight	0,243 kg	0,254 kg	0,271 kg	0,305 kg	-	-	-	-	-	-
Comp.										

SL60 Pressure Resistance

Pressure measuring point

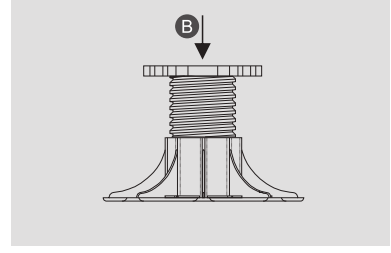
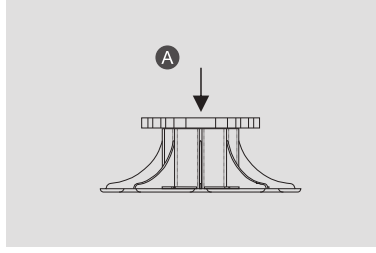

A Minimum highness

COMPRESSION TEST (HOT 23°)

B Maximum highness

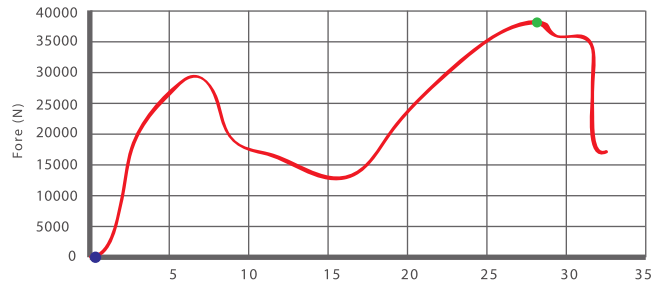
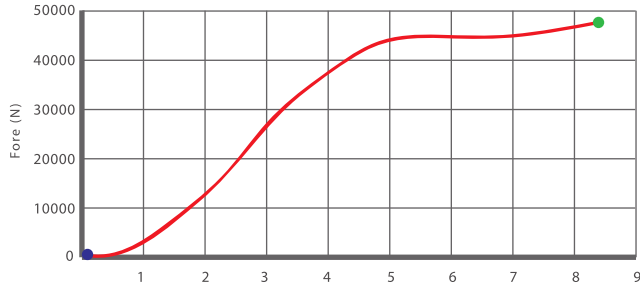

A Minimum highness

COMPRESSION TEST (COLD -40°)

B Maximum highness

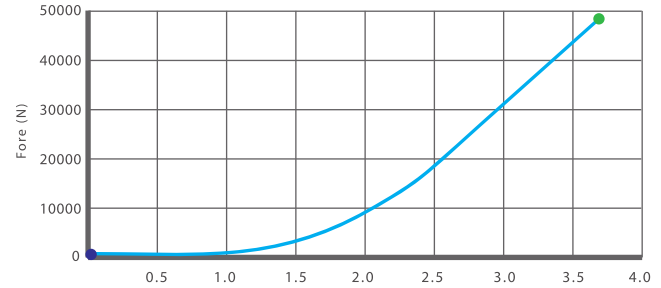
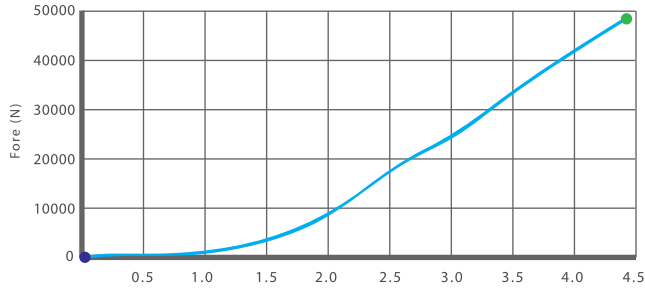

TESTED AND APPROVED BY HEADSHIP OF TURKISH STANDARDS INSTITUTION (TSE) AND CALIBRATION CENTER CONSTRUCTION MATERIALS LABORATORY (ANKARA CITY)

SL60 Packaging Information

Product code	SL60-01	SL60-02	SL60-03	SL60-04	M06050	M06075
Pcs per box	70*	60*	45*	35*	60***	40***
Gross weight per box	18,50 kg	16,65 kg	13,60 kg	12,10 kg	5,40 kg	4,00 kg
Boxes per pallet	12	12	12	12	48	48
Box dimensions	60cm x 40cm [*] x h=40cm		40cm x 30cm ^{**} x h=41cm		40cm x 30cm ^{***} x h=20cm	
Gross weight per pallet	247 kg	225 kg	189 kg	170 kg	285 kg	217 kg
Pallet dimensions	cm 80 x 120 x h140					

* Products are packed in cardboard boxes. Shrink-wrapped euro-pallets are used for final packaging. In spite of being shrink-wrapped and rain proof packagings, recommended to keep the pallets in closed area.

* The technical data products above indicate the current production. It may be updated or modified at any time without prior notice by Öztürk Plastik Kalıp San. Tic. Ltd. Şti..

* We do not take any responsibility for any problem which caused misuse of the products.