

installation for 1.0

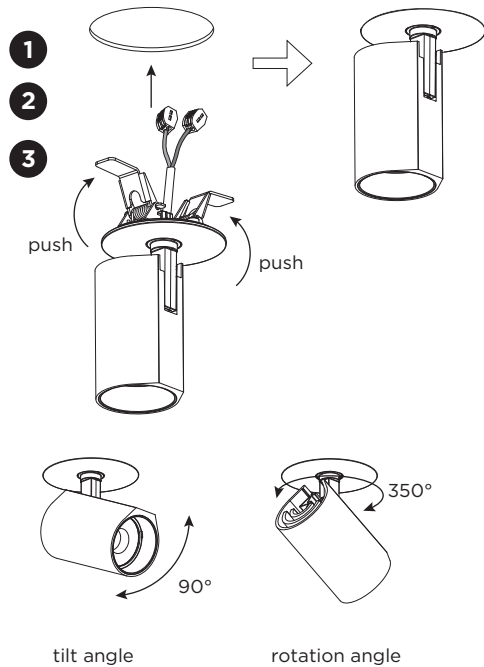

installation for 1.0 /2.0/3.0

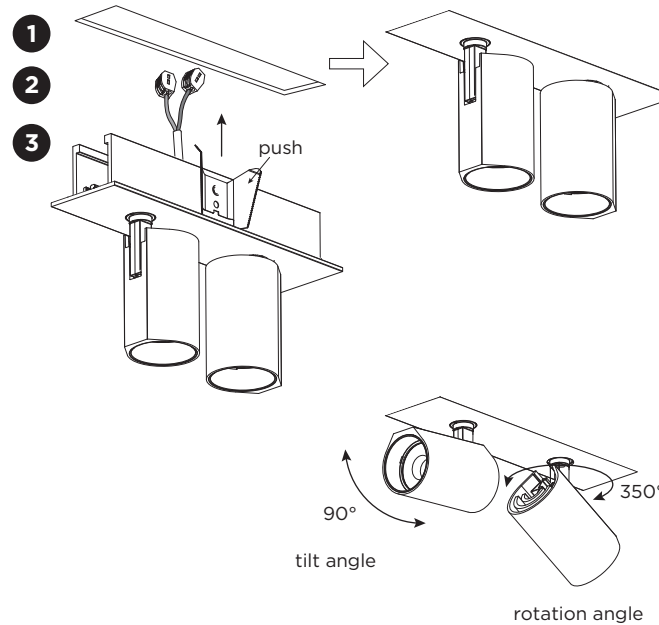

DIMENSIONS

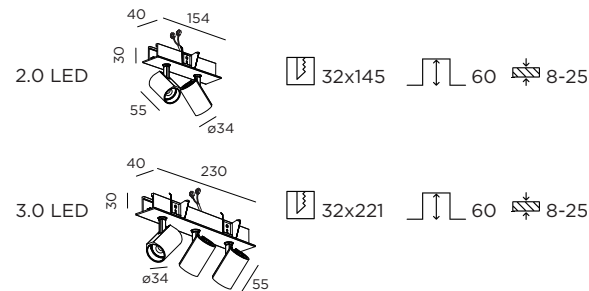
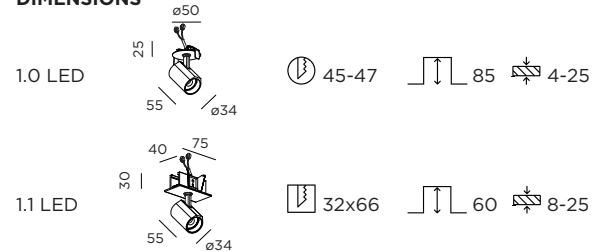

Driver must be powered off before connecting cables.

Before connecting the luminaire/LED module to the driver please make sure the driver is not powered but disconnected from the mains. The driver can only be powered when the luminaire/LED module is already connected. Disregarding this instruction might damage or even destroy the luminaire/LED module.

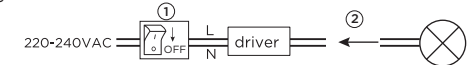

- Only to be installed outside arms reach.
- The LED chip of this luminaire is not replaceable; when the LED chip reached its end of life the whole luminaire shall be replaced.

MOUNTING INSTRUCTION

1 Make a hole in the ceiling according to the prescribed dimensions.

2 POWER CONNECTION

Always use a driver according to the specifications of the LED module.

Single connection

Connect to driver.

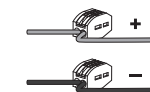
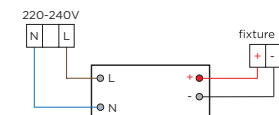

Multiple connection



3 Push the springs as shown and insert the fixture in the ceiling hole.

