

# TONONE

technical specifications



## BOLT floor long 2 arm upperfit

Design by Anton de Groof, 2013

Starting point for the products of Tonone is the passion for traditional mechanics. The first product line that resulted from this fascination is the lamp series 'Bolt'. Key element in this industrial series is the joint construction that can be adjusted with a wingnut-shaped tool. Besides being a functional tool, this wingnut is integrated in the design of the lamp itself as a distinctive visual element. The Bolt collection is available in 29 different models and in 11 colors.

Type	Floor lamp
Environment	Indoor
Material	Steel & aluminum
Wingnut	Wingnut Solid Brass included
Cord length	2900 mm
Weight	10,1 kg
Voltage	220-240 V
Max Watt	60 Watt
Socket	E27
IP	20
Lightsource	Lightsource not included
Dimmer	Phase cut dimmable with floor LED dimmer on cord
Packaging	
Weight	12,3 kg
Length	75 cm
Width	47 cm
Height	25 cm

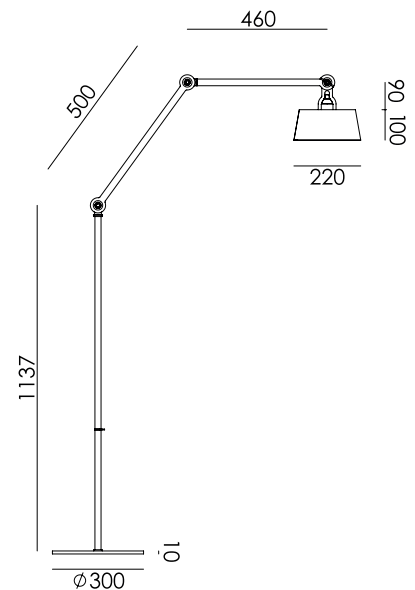











# TONONE

technical specifications



Article number

	smokey black	1360
	flux green	1361
	pure white	1363
	midnight grey	1367
	ash grey	1366
	striking orange	1364
	lightning white	1362
	thunder blue	1365
	daybreak rose	1469
	sunny yellow	1427
	ice blue	1612