

TONONE

technical specifications

BOLT 6-pack pendant

Design by Anton de Groof, 2013



Starting point for the products of Tonone is the passion for traditional mechanics. The first product line that resulted from this fascination is the lamp series 'Bolt'. Key element in this industrial series is the joint construction that can be adjusted with a wingnut-shaped tool. Besides being a functional tool, this wingnut is integrated in the design of the lamp itself as a distinctive visual element. The Bolt collection is available in 29 different models and in 11 colors.

Type	Pendant lamp
Environment	Indoor
Material	Steel & aluminum
Wingnut	Wingnut Solid Brass included
Cord length	Max 3000 mm
Weight	7 kg
Voltage	220-240 V
Max Watt	60 Watt
Socket	E27
IP	20
Lightsource	Lightsource not included

Packaging	
Weight	11 kg
Length	126 cm
Width	29 cm
Height	47 cm

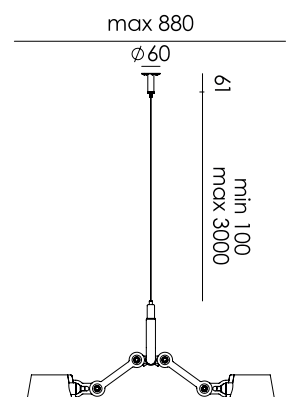
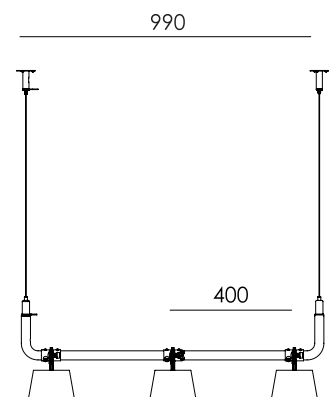

TONONE

technical specifications



Article number

	smokey black	1170
	flux green	1097
	pure white	1098
	midnight grey	1103
	ash grey	1102
	striking orange	1100
	lightning white	1099
	thunder blue	1101
	daybreak rose	1495
	sunny yellow	1453
	ice blue	1646