



# PEREGRINE



## Operating Instructions



Powerful • Simple • Reliable



# Table of Contents

Table of Contents.....	2
Conventions Used in this Manual.....	3
<b>1. Introduction .....</b>	<b>4</b>
1.1. Notes on this manual.....	5
1.2. Modes Covered by this Manual.....	5
<b>2. Basic Operation .....</b>	<b>6</b>
2.1. Turning On.....	6
2.2. Buttons.....	7
2.3. Button Hints.....	7
<b>3. Mounting Options .....</b>	<b>8</b>
3.1. Silicone strap.....	8
3.2. Shock Cord.....	8
<b>4. Dive Mode Interface.....</b>	<b>9</b>
4.1. Default Dive Setup.....	9
4.2. Dive Mode Differentiation.....	9
4.3. Main Screen.....	10
4.4. Detailed Descriptions.....	11
4.5. Info Screens.....	14
4.6. Info Screen Descriptions.....	15
4.7. Notifications.....	18
4.8. Customizable Alerts.....	21
4.9. List of primary notifications.....	22
<b>5. Safety and Decompression Stops .....</b>	<b>23</b>
5.1. Safety Stops.....	23
5.2. Decompression Stops.....	24
<b>6. Decompression and Gradient Factors ...</b>	<b>25</b>
6.1. Decompression Information Accuracy.....	26
<b>7. Example Dives .....</b>	<b>27</b>
7.1. Single Gas Example Dive.....	27
7.2. Multi-Gas Example Dive.....	28
7.3. Gauge Mode.....	30

<b>8. Menus .....</b>	<b>31</b>
8.1. Menu Structure.....	31
8.2. Turn off.....	32
8.3. Select Gas (3 GasNx only).....	32
8.4. Dive Setup.....	33
8.5. Dive Log.....	36
<b>9. System Setup Reference .....</b>	<b>38</b>
9.1. Mode Setup.....	38
9.2. Deco Setup.....	39
9.3. Bottom Row.....	40
9.4. Nitrox Gases.....	40
9.5. Alerts Setup.....	40
9.6. Display Setup.....	40
9.7. System Setup.....	41
9.8. Advanced Config.....	42
<b>10. Firmware Update and Log Download ....</b>	<b>44</b>
10.1. Shearwater Cloud Desktop.....	44
10.2. Shearwater Cloud Mobile.....	46
<b>11. Charging .....</b>	<b>47</b>
<b>12. Storage and Maintenance .....</b>	<b>48</b>
<b>13. Servicing.....</b>	<b>48</b>
<b>14. Glossary .....</b>	<b>49</b>
<b>15. Peregrine Specifications.....</b>	<b>50</b>
<b>16. Regulatory Information.....</b>	<b>51</b>
<b>17. Contact .....</b>	<b>51</b>



# DANGER

This computer is capable of calculating decompression stop requirements. These calculations are at best a guess of real physiological decompression requirements. Dives requiring staged decompression are substantially riskier than dives that stay well within no-stop limits. Diving with rebreathers and/or diving mixed gases and/or performing staged decompression dives and/or diving in overhead environments greatly increases the risk associated with scuba diving.

**YOU REALLY ARE RISKING YOUR LIFE WITH THIS ACTIVITY.**



# WARNING

This computer has bugs. Although we haven't found them all yet, they are there. It is certain that there are things that this computer does that either we didn't think about or planned for it to do something different. Never risk your life on only one source of information. Use a second computer or tables. If you choose to make riskier dives, obtain the proper training and work up to them slowly to gain experience.

This computer will fail. It is not whether it will fail but when it will fail. Do not depend on it. Always have a plan for how to handle failures. Automatic systems are no substitute for knowledge and training.

No technology will keep you alive. Knowledge, skill, and practiced procedures are your best defense (except for not doing the dive, of course).

## Conventions Used in this Manual

These conventions are used to highlight important information:



### INFORMATION

Information boxes contain useful tips for getting the most out of your dive computer.



### CAUTION

Caution boxes contain important instructions for operating your dive computer.



### WARNING

Warning boxes contain critical information that may affect your personal safety.



## Features

- Full color 2.2" LCD display
- Rugged rubber bumper
- Rated to 120m / 390ft
- Air, Single-gas Nitrox, and multi-gas Nitrox modes
- Simplified recreational diving modes
- Full decompression support
- Bühlmann ZHL-16C with gradient factors
- No lockout for violating deco stops
- CNS tracking
- Quick No-deco limit (NDL) planner
- Full decompression planner
- Customizable vibration alerts
- Programmable depth sampling rates
- Bluetooth dive log uploading to Shearwater Cloud
- Wireless charging
- Firmware upgrades over Bluetooth

## 1. Introduction

The Shearwater Peregrine is a dive computer for beginner to expert divers.

Please take the time to read this manual. Your safety may depend on your ability to read and understand the Peregrine displays.

Diving involves risk and education is your best tool for managing this risk.

Do not use this manual as a substitute for proper dive training and never dive beyond your training. What you don't know can hurt you.



## 1.1. Notes on this manual

This manual contains cross-references between sections to make it easier to navigate.

Underlined text indicates the presence of a link to another section.

**Do not change any settings on your Peregrine without understanding the consequence of the change.** If you are unsure, consult the appropriate section of the manual for reference.

This manual is not a substitute for proper training.



### **Firmware Version: V77**

This manual corresponds to firmware version V77.

Feature changes may have been made since this release and might not be documented here.

Check the release notes on [Shearwater.com](http://Shearwater.com) for a complete list of changes since the last release.

## 1.2. Modes Covered by this Manual

This manual provides operating instructions for all four dive modes available in the Peregrine:

- Air
- Nitrox
- 3 GasNx
- Gauge

Some features of the Peregrine only apply to certain dive modes. If not otherwise indicated, features described are applicable in all dive modes.

Change the Dive Mode from the Mode Setup menu.  
See details on page 38.



## 2. Basic Operation

### 2.1. Turning On

To turn the Peregrine on, press both buttons together.

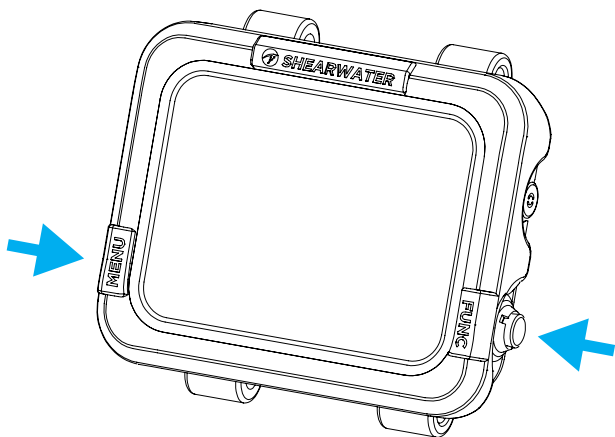

#### Auto-on

The Peregrine will automatically turn on when submerged underwater. This is based on pressure increase and not on the presence of water. When auto-on is activated, the Peregrine will enter the last configured dive mode.



#### **Do Not Rely On The Auto-On Feature**

This feature is supplied as a backup for when you forget to turn on your Peregrine.

Shearwater recommends turning your computer on manually before each dive to confirm proper operation and to double check battery status and setup.

#### Auto-on Details

The Peregrine turns on automatically when the absolute pressure is greater than 1100 millibar (mbar).

For reference, normal sea level pressure is 1013 mbar and 1 mbar of pressure corresponds to approximately 1 cm (0.4") of water. So, when at sea level, the Peregrine will automatically turn on and enter dive mode when about 0.9 m (3 ft) underwater.

If at higher altitude, then the Peregrine auto-on will occur at a deeper depth. For example, when at 2000 m (6500 ft) altitude the atmospheric pressure is only about 800 mbar. Therefore, at this altitude the Peregrine must be submerged underwater by 300 mbar to reach an absolute pressure of 1100 mbar. This means the auto-on occurs at about 3 m (10 ft) underwater when at an altitude of 2000 m.

#### Customizable Splash Screen

After turning on, the Peregrine Splash Screen is displayed for 2 seconds.

Customizable start up text can be added using the Shearwater Cloud Desktop app.

The image itself can also be customized using the Shearwater Cloud Desktop App.

See the section on [Connect to Shearwater Cloud Desktop](#) on page 44 for details.



## 2.2. Buttons

Apart from turning on, all Peregrine operations are simple single button presses.

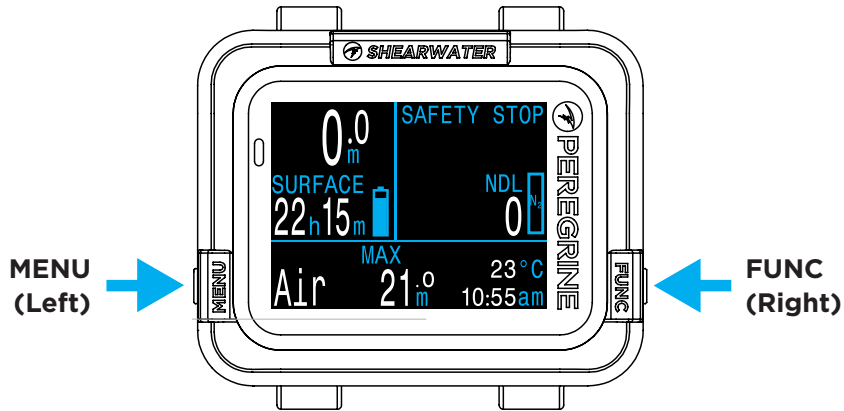

Don't worry about remembering all the button rules below. Button hints make using the Peregrine easy.

### MENU Button (Left)

- From the main screen > Cycles through menus.
- In a menu > Cycles through menus and options.

### FUNC Button (Right)

- From the main screen > Cycles through info screens
- In a menu > Selects menu or option

## 2.3. Button Hints

When in a menu, button hints indicate the function of each button.

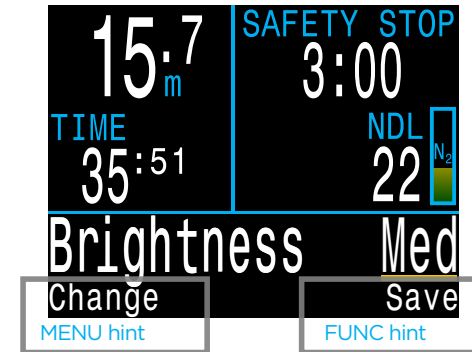



## 3. Mounting Options

The Peregrine is shipped with both a silicone strap and shock cord. Before first use, you will need to install your preferred mounting option.

### 3.1. Silicone strap

The included Peregrine strap is made of a durable, stretchy silicone, designed to grip a wet suit or dry suit without sliding around. Several strap colour options are available (black is included).

The strap is fastened to the Peregrine via stainless steel lugs which can be easily removed and replaced with two standard Phillips screwdrivers (included). The lug threads come with a pre-applied locking element that performs best when tightened fewer than 5 times.

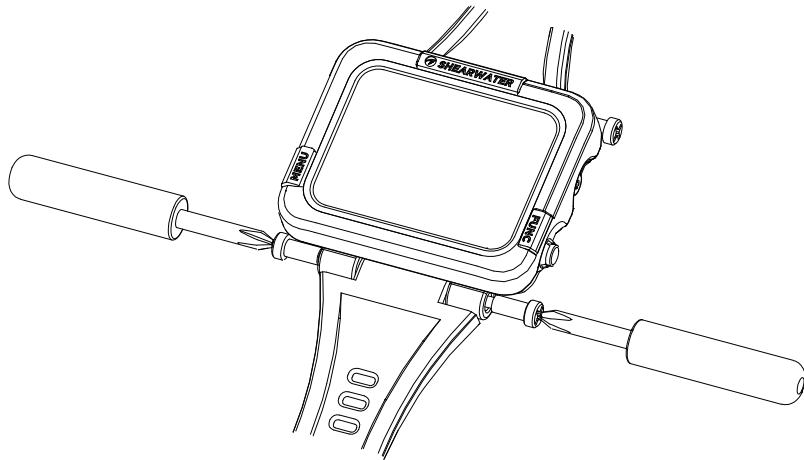

#### **DO NOT OVER TORQUE LUG SCREWS**

Once it feels tight, stop screwing. Over torquing can damage screw threads.

### 3.2. Shock Cord

Shock cord or bungee can be installed in many ways on the Peregrine. The Peregrine's holes are sized for 4mm cord.

The simplest option is to secure the shock cord is with four simple overhand knots. However, this method is not adjustable and a knot might pull through its mounting hole at very high load.

Another method is to use slip knots. This provides adjust ability when changing exposure protection.





## 4. Dive Mode Interface

### 4.1. Default Dive Setup

The Peregrine comes pre-configured for recreational diving.

The default dive mode for the Peregrine is a simple Air only mode.

As a quick reference, a diagram of the default diving display is shown below.

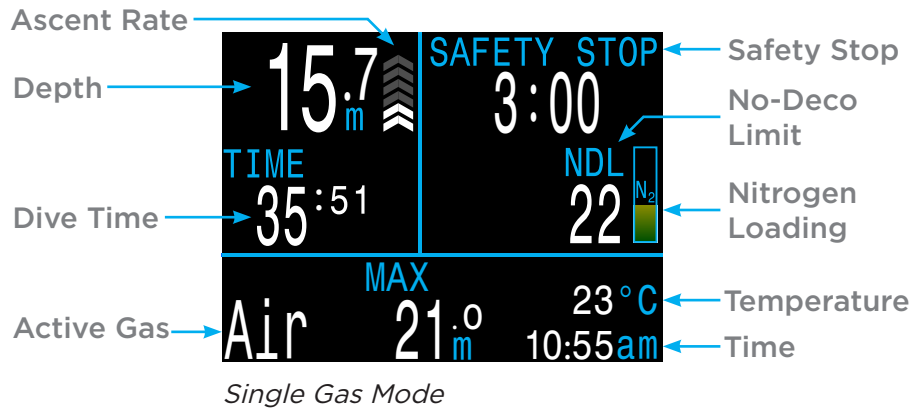

Many attributes of this default mode are shared with the other dive modes. The following sections go into detail about each screen element.

See the [Single Gas Example Dive on page 27](#) for a walk through of how this screen changes through all phases of a dive.

### 4.2. Dive Mode Differentiation

Each dive mode is designed to best suit a particular type of diving.

#### Air

Designed for use during recreational, air only, no-decompression diving activities.

- Air (21% oxygen) only, not switchable underwater
- Simplified Info Rows
- Enhanced warnings

#### Nitrox (Single Gas)

Designed for use during recreational, Nitrox, no-decompression diving activities.

- Single Gas Nitrox up to 40% oxygen
- No gas switching underwater
- Simplified Info Rows
- Enhanced warnings

#### 3 GasNx (Three Gas Mode)

Designed for use during advanced diving activities including light technical diving involving planned decompression.

- Three programmable gases
- Support for gas switching
- Nitrox up to 100%

#### Gauge

Gauge Mode turns the Peregrine into a simple depth and time display (a.k.a. a bottom timer). [See page 30.](#)

- No tissue tracking
- No decompression information

[Change the Dive Mode from the Mode Setup menu.](#)  
[See details on page 38.](#)



## 4.3. Main Screen

The Main Screen shows the most important information for Air and Nitrox diving.

It is divided into three sections: Basic dive info, decompression info, and the Info Row.



*Main Screen Sections*

The Basic Dive Info section and the Decompression Info section content are reserved for the most critical information and are fixed. Pressing the FUNC (right) button scrolls through additional data in the Info row.

### Basic Dive Info

The Basic Dive area shows:

- The current depth (in feet or meters)
- The dive time in minutes and seconds

When on the surface, the dive time is replaced by a surface interval timer. Also, a battery gauge will appear in this area.

### Decompression Info

The Decompression area shows:

- Safety stops (if enabled)
- Decompression stops
- No-Decompression Limit (NDL) in minutes
- Nitrogen loading bar graph
- Warnings for Maximum Operating Depth (MOD) and Central Nervous System oxygen toxicity (CNS)

### Configurable Info Row

The bottom-left position on the home screen always shows the currently selected gas.

The center and right positions can be configured to display a variety of different information. By default they show maximum depth, time of day and temperature.

See [“Configurable Info Row”](#) on page 13 for customization options.

Pressing the FUNC (right) button will cycle the Info Row through additional data. Pressing the MENU (left) button will return the info row to the home screen.



## 4.4. Detailed Descriptions

### Basic Dive Info Area

The Basic Dive Info Area shows depth, dive time, ascent rate, and state of battery charge (when at the surface).

#### Depth

The depth is shown in the top left. When in meters, one decimal place is shown.

Note: If the depth shows a Flashing Red zero or shows at depth at the surface, then the depth sensor needs service.

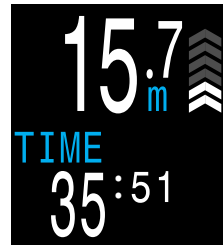

*Depth in Meters and Dive Time*

#### Dive Time

Dive time displays in minutes and seconds. It begins and ends counting automatically when you dive.

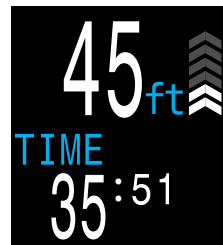

*Depth in Feet and Dive Time*

#### Surface Interval

When on the surface, the dive time is replaced by the surface interval in hours and minutes. Beyond 96 hours(4 days), it displays in days.



The surface interval resets when decompression tissues are cleared.

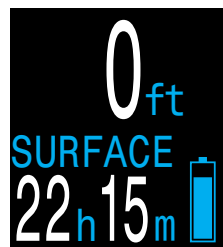

*Surface interval and battery symbol*

### Ascent Rate Display

Shows how fast you are currently ascending graphically.

1 arrow per 3 meters per minute (mpm) or 10 feet per minute (fpm) of ascent rate.



**WHITE** when less than 9 mpm / 30 fpm (1 to 3 arrows)



**YELLOW** when greater than 9 mpm / 30 fpm and less than 18 mpm / 60 fpm (4 or 5 arrows)



**FLASHING RED** when greater than 18 mpm / 60 fpm (6 arrows)

Note: Deco calculations assume 10mpm (33fpm) ascent rate.

### Battery Icon

The battery icon is shown on the surface but disappears when diving. If low or critical then the battery icon will appear while diving.



**BLUE** when battery charge is OK



**YELLOW** when battery needs to be charged.



**RED** when battery must be charged immediately.



## Decompression Info Area

### No Decompression Limit (NDL)



The time remaining, in minutes, at the current depth until decompression stops will be necessary.



Displays in Yellow when the NDL is less than the low NDL limit (Default 5 minutes).

### Safety Stop

Appears when a safety stop is recommended and counts down automatically when in the safety stop range.

Safety stops may be turned off, set to fixed times of 3, 4, or 5 minutes, set to adapt based on dive conditions, or be set to count up from zero.

See [Safety Stops on page 23](#) for details.

### Deco Stop Depth and Time

Once NDL = 0 minutes, mandatory decompression is required. The safety stop counter will be replaced by the shallowest depth to which you can ascend and how long to hold that stop.

See [Decompression Stops on page 24](#) for details.



*NDL > 0 minutes  
Safety Stop  
suggested*

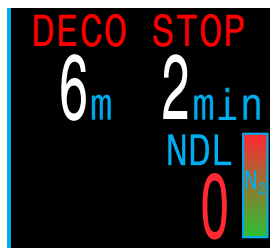

*NDL = 0 minutes  
Decompression  
Stops Required*

### Nitrogen Loading Bar Graph

The nitrogen bar graph is scaled such that it is full once decompression stops will be needed.

On ascent, it gives a much better indication of decompression stress and the risk of decompression sickness than NDL does.

On the surface, the Nitrogen Loading Bar Graph shows the residual nitrogen from the previous dive.

### Persistent Notifications

Persistent notifications are displayed to the left of NDL. If multiple warnings are triggered, only the highest priority will display.

Read more about [Notifications on page 18](#) for more information on warnings.



### **Important!**

All decompression information including Deco Stops, NDL, and Time to surface are predictions that assume:

- Ascent rate of 10mpm / 33fpm
- Decompression stops will be followed
- All programmed gases will be used as appropriate

Read more about [Decompression and Gradient Factors on page 25](#).



### Configurable Info Row

The Home Screen is the default display for the info row. Information in the center and right positions can be customized.



#### Active Gas

The active gas position is not configurable. It always shows the currently selected breathing gas.



When air (21% O<sub>2</sub>) is used, the value “Air” is displayed.

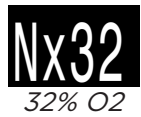

For all other gases, it displays “Nx” (Nitrox) followed by the O<sub>2</sub>%.



*Better Gas available*

The gas will display in yellow if a better gas is available. (3 GasNx mode only)

The gas will display in flashing red if the MOD of the gas has been exceeded.

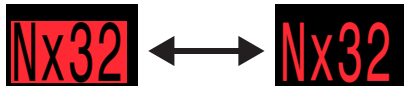

*Gas displayed in flashing red when MOD has been exceeded*

### Configurable Center & Right Positions

Many possible configurations can be set for the center and right positions of the bottom row.

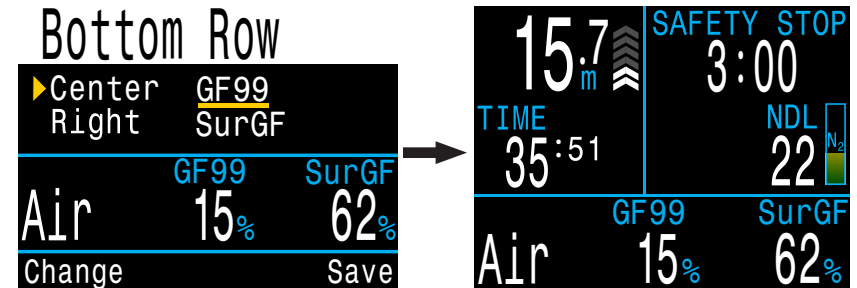

All dive modes share the same home screen customization.

See details for how to change the configuration of the Bottom Row on page 40.

All bottom row options are listed below. Descriptions of each function can be found in the next section (INFO Screens)

Option	Info Display	Option	Info Display
Max Depth	MAX 31.6m	TTS	TTS 14
Avg. Depth	AVG 13.3m	PPO2	PPO2 .21
Clock	TIME 2:31	CNS %	CNS 11%
Timer	TIMER 4:57	MOD	MOD 57
Temperature	TEMP 21°C	GF99	GF99 22%
Ceiling	CEIL 11	Surf. GF	SurfGF 136%
Dive End Time	DET 2:43	Δ+5	Δ+5 0
Rate	RATE ↑10 m/min	@+5	@+5 20



## 4.5. Info Screens

Info screens provide more information than is available on the main screen.

From the main screen, the FUNC (right) button steps through info screens.

When all info screens have been viewed, pressing FUNC again will return to the main screen.

Pressing the MENU (left) button will also return to the home screen at any time.

Info screens also automatically time-out after 10 seconds, returning to the home screen. This prevents active gas information from being hidden for an extended period.

Note that the Tissues Info screen does not automatically time out. This allows tissue off-gassing to be observed on an extended deco stop without having to cycle back to it repeatedly.

Although these screens are generally representative of the Peregrine display, info screen content varies for each mode. For example, decompression related info screens are not available in gauge mode.

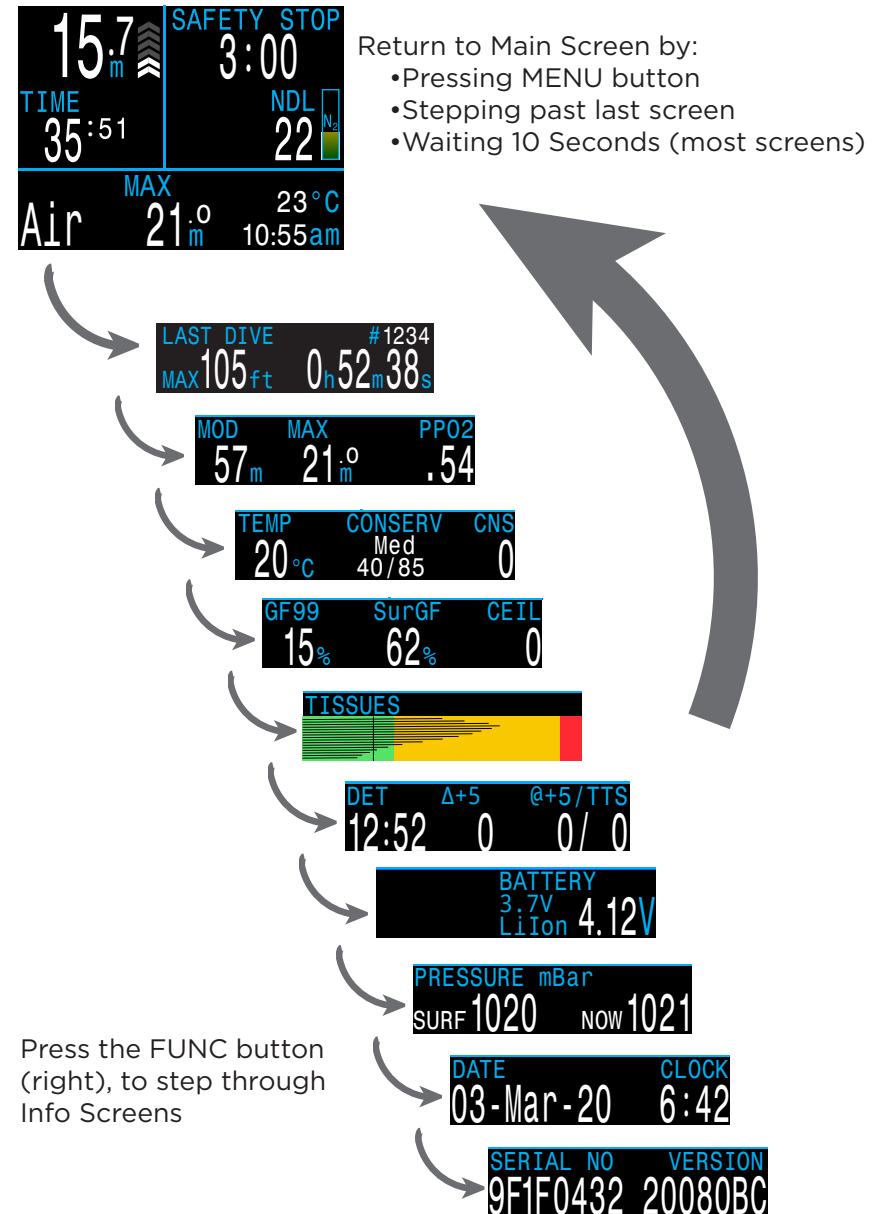



## 4.6. Info Screen Descriptions

### Last Dive Info Screen

LAST DIVE #1234  
MAX 105 ft 0h 52m 38s

Maximum depth and dive time from the last dive. Only available at the surface.

### Maximum Operating Depth

MOD 57 m

MOD is the maximum allowable depth of the current breathing gas as determined by PPO2 limits.

Displays in **Flashing Red** when exceeded.

### Maximum Depth

MAX 21.0 m

The maximum depth of the current dive. When not diving, displays the maximum depth of the last dive

### Partial Pressure of Oxygen (PPO2)

PPO2 .54

PPO2 of the current breathing gas. Displays in **Flashing Red** when outside customizable PPO2 limits.

Read more about PPO2 Limits on [page 43](#).

### Temperature

TEMP 20 °C

The current temperature in degrees Celsius or degrees Fahrenheit. Temperature units can be set in the Display settings menu.

### Conservatism

CONSERV Med 40/85

The conservatism values for the Bühlmann GF decompression algorithm.

Read more about [Decompression and Gradient Factors](#) on [page 25](#).

### CNS Toxicity Percentage

CNS 11%

Central Nervous System oxygen toxicity loading percentage (CNS). Turns **Yellow** when greater than 90%. Turns **Red** when greater than 150%.

CNS 101%

The CNS percentage is calculated continuously, even when the dive computer is on the surface and turned off. When deco tissues are reset, the CNS will also be reset.

The CNS value (short for Central Nervous System Oxygen Toxicity) is a measure of how long you have been exposed to elevated partial pressures of oxygen (PPO2) as a percentage of a maximum allowable exposure. As PPO2 goes up, the maximum allowable exposure time goes down. The table we use is from the NOAA Diving Manual (Fourth Edition). The computer linearly interpolates between these points and extrapolates beyond them when necessary. Above a PPO2 of 1.65 ATA, the CNS rate increases at a fixed rate of 1% every 4 seconds.

During a dive the CNS never decreases. When back at the surface, a half-life of elimination of 90 minutes is used.

For example, if at the end of the dive the CNS was 80%, then 90 minutes later it will be 40%. In 90 more minutes it will be 20%, etc. Typically, after about 6 half-life times (9 hours), everything has returned close to equilibrium (0%).



## GF99

**GF99**  
**15%**

The current gradient factor as a percentage of the controlling compartment m-value (i.e. super-saturation percent gradient)

0% means the leading tissue super-saturation is equal to ambient pressure. Displays “On Gas” when tissue tension is less than the inspired inert gas pressure.

100% means the leading tissue super-saturation is equal to the original M-Value limit in the Bühlmann ZHL-16C model.

GF99 is displayed in **Yellow** when the current gradient factor modified M-Value (GF High) is exceeded.

GF99 is displayed in **Red** when 100% (un-modified M-Value) is exceeded.

## Surface GF

**SurGF**  
**62%**

The surfacing gradient factor expected if the diver instantaneously surfaced.

SurGF colour is based on the current GF (GF99). If the current GF is greater than GF High, SurGF will be displayed in **Yellow**. If the current gradient factor is greater than 100%, SurGF will be displayed in **Red**.

## Ceiling

**CEIL**  
**0**

The current decompression ceiling not rounded to the next deeper stop increment. (i.e. not a multiple of 10ft or 3m)

## Time To Surface

**TTS**  
**14**

The Time-To-Surface (TTS) in minutes. This is the current time to ascend to the surface including the ascent plus all required deco stops and safety stops.

### @+5

**@+5**  
**0**

“At plus 5” is the TTS if remaining at the current depth for 5 more minutes. This can be used as a measure of how fast you are on-gassing or off-gassing.

### Δ+5

**Δ+5**  
**0**

The predicted change in TTS if you were to stay at the current depth for 5 more minutes.

A positive “Delta plus 5” indicates that you are on-gassing the leading tissue while a negative number indicates that you are off-gassing the leading tissue.

## Dive End Time (DET)

**DET**  
**12:52**

The time of day at which you can expect to surface if you depart immediately, ascend at 10mpm or 33fpm, change gases when prompted, and perform all decompression stops as directed.





## Tissues Bar Graph



The tissues bar graph shows the tissue compartment inert gas tissue tensions based on the Bühlmann ZHL-16C model.

Each bar represents the nitrogen inert gas tension for one compartment. The fastest tissue compartment is shown on the top, and the slowest on the bottom. Pressure increases to the right.

The vertical black line shows the inspired partial pressure of nitrogen. The green-yellow interface line is the ambient pressure. The yellow-red interface line is the ZHL-16C M-Value pressure.

Tissues that are supersaturated above ambient pressure extend into the yellow, and tissues that are supersaturated above the M-Value extend into the red.

Note that the scale for each tissue compartment is different. The reason the bars are scaled in this way is so that the tissues tensions can be visualized in terms of risk (i.e. how close they are as a percentage to Bühlmann's original super-saturation limits). Also, this scale changes with depth, since the M-Value line also changes with depth.

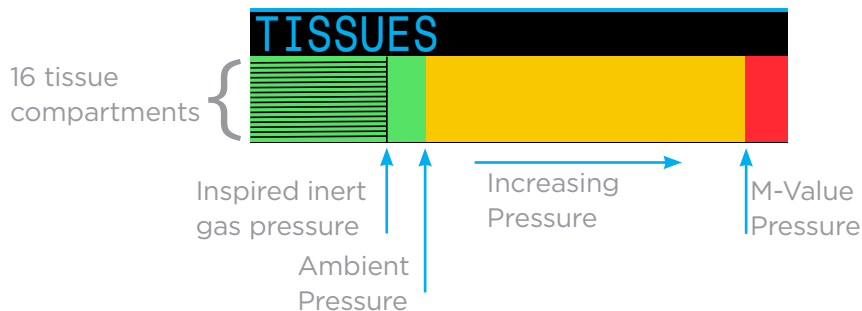

## Sample Tissue Bar Graphs



On surface (sat. with air)  
Note: Gas is 79% N<sub>2</sub> (21% O<sub>2</sub>, or Air)



Immediately after descent



On Gassing



Deepest Stop



Last deco Stop  
Note: Gas is now 50% O<sub>2</sub> and 50% N<sub>2</sub>



## Pressure



The pressure in millibar. Two values are shown, the surface (surf) pressure and the current (now) pressure.

Note that typical pressure at sea level is 1013 millibar, although it may vary with the weather (barometric pressure). For example, in a low pressure system surface pressure may be as low as 980 millibar, or as high as 1040 millibar in a high pressure system.

For this reason, the PPO2 displayed on the surface may not exactly match the FO2 (fraction of O2), although the displayed PPO2 is still correct.

The surface pressure is set based on the lowest pressure the Peregrine sees in the 10 minutes prior to computer turn on. Therefore, altitude is automatically accounted for and no special altitude setting is required.

## Battery

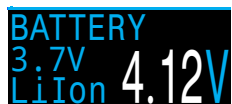

Current voltage of the internal battery. Displays in yellow when battery is low and needs to be recharged. Displays in red when battery is critically low and must be recharged immediately.

## Clock



In a 12 or 24 hour format. Time format can be changed in the watch settings menu.

## Date



In the format Day-Month Year.

## 4.7. Notifications

This section describes the different types of notifications the computer may present the diver.

See the [List of primary notifications on page 22](#) that a diver may encounter.

### Color Coding

Color coding of text draws attention to problems or unsafe situations.

**WHITE** text indicates normal conditions by default.

Note that this normal condition color can be selected in the advanced configuration menu, described on [page 42](#).

**YELLOW** is used for warnings that are not immediately dangerous but should be addressed.



*Sample warning - a better gas is available*

**FLASHING RED** is used for critical warnings that could be life threatening if not immediately addressed.

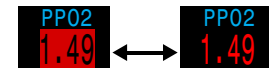

*Sample critical warning - Continuing to breathe this gas could be fatal*



### Color blind users

The warning or critical warning states can be determined without the use of color.

**Warnings** display on a solid inverted background.



Doesn't flash

**Critical Warnings** flash between inverted and normal text.



Flashes



## Types of Notifications

### Primary Notifications

Each of the primary notifications will display as a message in yellow across the bottom row until dismissed.



Sample Primary notification - High PPO2 Warning

The notification is dismissed by pressing either button.

For example, this “HIGH PPO2” message will appear if the average PPO2 goes above the PPO2 limit for more than 30 seconds.

The highest priority notification is listed first. If multiple errors occur simultaneously, the notification with the highest priority will be displayed. Clear the first notification by pressing a button to see the next one.

If vibration alerts are on, the unit will vibrate when the alert first occurs and every 10 seconds until it is acknowledged.

A list of primary notifications a diver may see is given on [page 22](#).

### Persistent Notifications

When the computer detects a dangerous situation, such as high PPO2, a warning is triggered. The large primary notification can be dismissed, but in most cases, a persistent notification will remain on the screen to the left of the NDL until the condition that caused the warning is resolved.

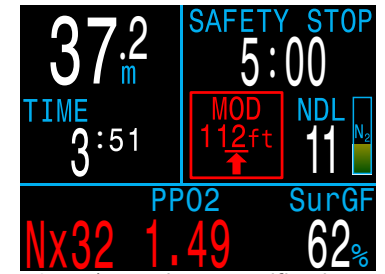

Sample Persistent Notification - MOD Exceeded

### List of Persistent Notifications

#### High CNS

Central Nervous System (CNS) Oxygen Toxicity limit reached.

#### MOD, go up

Maximum Operating Depth (MOD) exceeded. Ascend to shown depth.

#### MOD, switch gas

Maximum Operating Depth (MOD) exceeded. Switch to more appropriate gas (another gas must be programmed and turned on for this to appear).

#### Near MOD

Within 5ft (1.9m) below MOD. Just a notification, no action required.

#### Better Gas

Another gas is programmed that is more suitable at the current depth. Only displays when deco stops are needed.

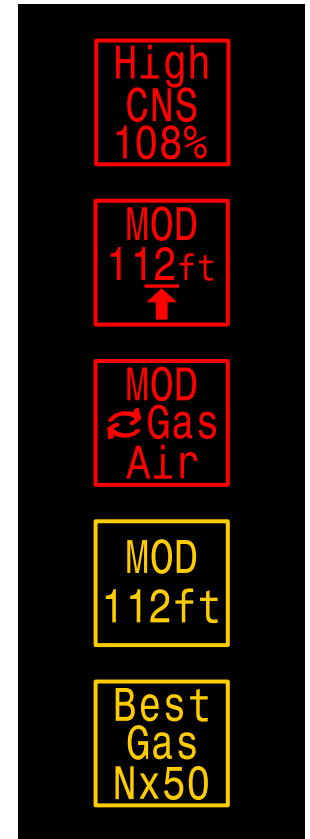



## Vibration Alerts

In addition to visual notifications, the Peregrine has vibration alerts to help quickly notify the diver of warnings, errors and dive events.

If turned on, attention vibration alerts occur when a safety stop starts, pauses, or is completed. Vibration alerts will also occur any time a primary notification is triggered and every 10 seconds until it is acknowledged.

The vibration alert settings can be changed in the System Setup menu as described in [Alerts Setup on page 40](#), or in the Dive Setup menu described on [page 36](#).

It's important the diver is aware of what type of notification they can expect on a dive.

A Test Vibration tool is also available in the Dive Setup menu and should be used regularly before diving to ensure the vibrator is functioning properly.



If you do not like vibrating alerts, they are easily silenced.



### Caution

Although vibration alerts are very useful, never rely on them for your safety. Electromechanical devices can and will eventually fail.

Always be proactively aware of your depth, no-decompression limit, gas supply, and other critical dive data. You are ultimately responsible for your own safety.



### Limitations of Alarms

All alarm systems share common weaknesses.

They can alarm when no error condition exists (false positive). Or they can fail to alarm when a real error condition occurs (false negative).

Respond to alarms if you see them, but NEVER depend on them. Your judgment, education, and experience are your best defenses. Have a plan for failures, build experience slowly, and dive within your experience.



## 4.8. Customizable Alerts

In addition to automatic warnings indicating potentially dangerous situations, the Peregrine has customizable alerts for maximum depth, maximum dive time, and minimum no-decompression limit.

These alerts can be configured in [Alerts Setup](#) as described on page 40.

### Depth Alert

By default the depth alert is set to 40 meters.

In addition to the Primary notification which can be dismissed, the depth value will turn yellow when deeper than the Alert value.



The depth alert will reset if the depth goes 2m shallower than the alert depth.

### Time Alert

By default the dive time alert is set to 60 minutes, but is turned off.

In addition to the Primary notification which can be dismissed, the dive time value will turn yellow when greater than the Alert value.



The time alert will only fire once per dive.

### Low NDL Alert

By default the low NDL alert is set to 5 minutes.

In addition to the Primary notification which can be dismissed, the NDL value will turn yellow when at or below the Alert value.



The NDL alert will reset if the NDL goes above the NDL alert value by 3 minutes.

Example: If NDL Alert value is 5 minutes, The NDL Alert will reset once NDL reaches 8 minutes.



## 4.9. List of primary notifications

The following table lists primary notifications you may see, their meaning, and steps to take to solve any problems.

The highest priority notification is listed first. If multiple warnings are triggered simultaneously, the notification with the highest priority will be displayed. Clear that notification by pressing any button to see the next notification.



### Contact Shearwater

The subsequent list of notifications is not exhaustive. Please contact Shearwater if you experience any unexpected errors: [info@shearwater.com](mailto:info@shearwater.com)

Display	Meaning	Action to take
<b>Warning</b> Confirm <b>LOW PPO2</b>	The PPO2 is below the limit set in the PPO2 limits menu.	Change your breathing gas to one safe for the current depth.
<b>Warning</b> Confirm <b>HIGH PPO2</b>	The PPO2 is above the limit set in the PPO2 limits menu.	Change your breathing gas to one safe for the current depth.
<b>Warning</b> Confirm <b>MISSED DECO STOP</b>	A required decompression stop was violated.	Descend deeper than the currently displayed stop depth. Monitor for symptoms of DCS. Use extra conservatism for future repetitive dives.
<b>Warning</b> Confirm <b>FAST ASCENT</b>	The ascent was sustained as faster than 10m/min (33ft/min)	Use a slow ascent rate. Monitor for symptoms of DCS. Use extra conservatism for future repetitive dives.

Display	Meaning	Action to take
<b>Warning</b> Confirm <b>LOW BATTERY INT</b>	The internal battery is low.	Recharge the battery.
<b>Warning</b> Confirm <b>TISSUES CLEARED</b>	The decompression tissue inert gas loading has been set to default levels.	Plan repetitive dives accordingly.
<b>Warning</b> Confirm <b>VERY HIGH CNS</b>	Central Nervous System (CNS) toxicity clock exceeded 150%	Switch to a gas with a lower PPO2 or ascend shallower (decompression ceiling allowing)
<b>Warning</b> Confirm <b>HIGH CNS</b>	Central Nervous System (CNS) toxicity clock exceeded 90%	Switch to a gas with a lower PPO2 or ascend shallower (decompression ceiling allowing)
<b>Alert</b> Confirm <b>Low NDL Alert</b>	NDL is less than low NDL alert value.	Ascend soon to avoid decompression obligation.
<b>Alert</b> Confirm <b>Depth Alert</b>	Depth is deeper than depth alert value.	Ascend above depth limit.
<b>Alert</b> Confirm <b>Time Alert</b>	Divetime has surpassed time alert value.	End dive safely.



## 5. Safety and Decompression Stops

Safety and decompression stops are pauses inserted into the ascent to the surface in order to reduce the risk of decompression illness (DCI).

### 5.1. Safety Stops

A safety stop is an optional stop added to all dives before surfacing. Safety stops can be set to fixed times of 3, 4, or 5 minutes, set to adapt based on dive conditions, or turned off completely. See [Deco Setup](#) on page 39 for more info.

The Peregrine does not do “deep safety stops”. That is, there are no extra stops added around 15m to 18m (50ft to 60ft) when ascending from a no-deco dive.

Safety stops behave as follows:

#### Safety Stop Required

Once the depth exceeds 11m (35ft), a safety stop will be counter will appear in the top right corner of the display.



#### Automatic Countdown

Countdown begins once the depth becomes shallower than 6m (20ft). Countdown will continue while the depth remains in the range of 2.4m to 8.3m (7ft to 27ft).



#### Countdown Paused

If the depth goes outside of the range 2.4m to 8.3m (7ft to 27ft), then the countdown pauses, and the remaining time displays in yellow.



#### Safety Stop Complete

When the countdown reaches zero, the display changes to “Complete” and you are now clear to ascend to the surface.



#### Countdown Reset

The countdown will reset if the depth once again exceeds 11m (35ft).



#### No Lockout for omitting

There is no lock-out or other penalty for omitting a safety stop, as they are optional.

If you ascend to the surface before the safety stop countdown finishes, the safety stop will appear paused, but this will disappear once the dive ends.

We recommend performing safety stops as planned as they offer a reduction in risk of DCI and take little time.

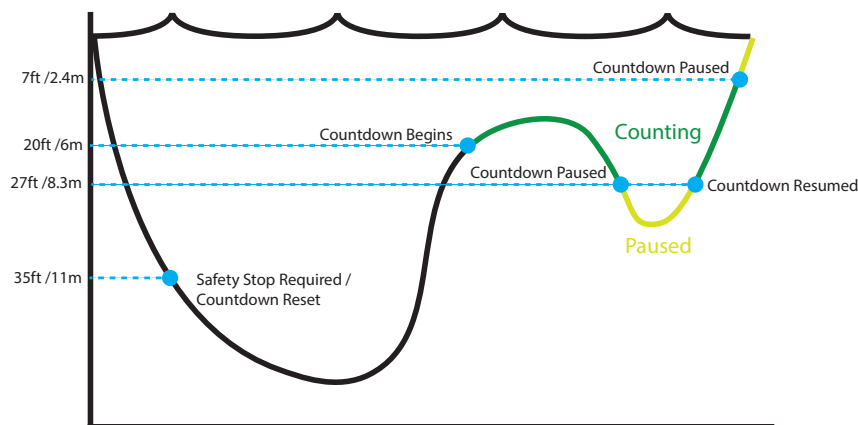

Safety Stop Thresholds - Not to scale



## 5.2. Decompression Stops

Decompression stops are mandatory stops that must be followed in order to reduce the risk of decompression illness (DCI).



### Do not dive beyond your training

Only perform decompression diving if you have received proper training to do so.

Diving with any type of overhead ceiling, whether in a cave or shipwreck, or from a decompression requirement, adds significant risk. Have a plan to handle failures and never rely solely on a single source of information.

Decompression stops occur at fixed 3m (10ft) intervals.

Decompression stops display as follows:

#### Replaces Safety Stop

Once the NDL reaches zero, deco stop information will replace safety stop display.



#### Approach Indicator

As you approach within 17ft (5.1m) of the first decompression stop, the title will change from red to yellow and a flashing up-arrow will indicate to ascend to the stop.



#### At Deco Stop

While at the stop depth or up to 5ft (1.5m) deeper, the title will turn green and a check mark will be shown. Hold this depth until stop time clears.



#### Deco Stop Violation

If you ascend shallower than a deco stop, the display will **flash red**. Significant stop violations will result in a “MISSED STOP” notification.



#### Deco Stops Complete

Once all decompression stops are complete, the safety stop will begin counting down.



If enabled, the Deco Clear counter will begin counting up from zero.

If safety stops and deco clear counter are disabled “Complete” will appear across the deco stop information area.



### No Lockout for violating Deco Stops

There is no lock-out or other penalty for violating decompression stops.

The policy is to provide clear warnings that the decompression scheduled was violated, to allow you to make decisions based on your training.

This may include contacting your dive insurance provider, contacting the nearest recompression chamber, or performing first aid based on your training.





## 6. Decompression and Gradient Factors

The basic decompression algorithm used by this computer is Bühlmann ZHL-16C. It has been modified by the use of Gradient Factors that were developed by Erik Baker. We have used his ideas to create our own code to implement it. We would like to give credit to Erik for his work in education about decompression algorithms, but he is in no way responsible for the code we have written.

The computer implements Gradient Factors creating varied levels of conservatism. The levels of conservatism are pairs of numbers like 30/70. For a more detailed explanation of their meaning, please refer to Erik Baker's excellent articles: "Clearing Up The Confusion About Deep Stops" and "Understanding M-values". The articles are readily available on the web. You might also want to search for "Gradient Factors" on the web.

The default conservatism of the system in all dive modes is medium (40/85).

The system provides settings that are more aggressive and more conservative than the default.

**Do not edit GF values until you understand the effects.**

Graph from Erik Baker's "Clearing Up The Confusion About Deep Stops"  
Pressure Graph: Gradient Factors

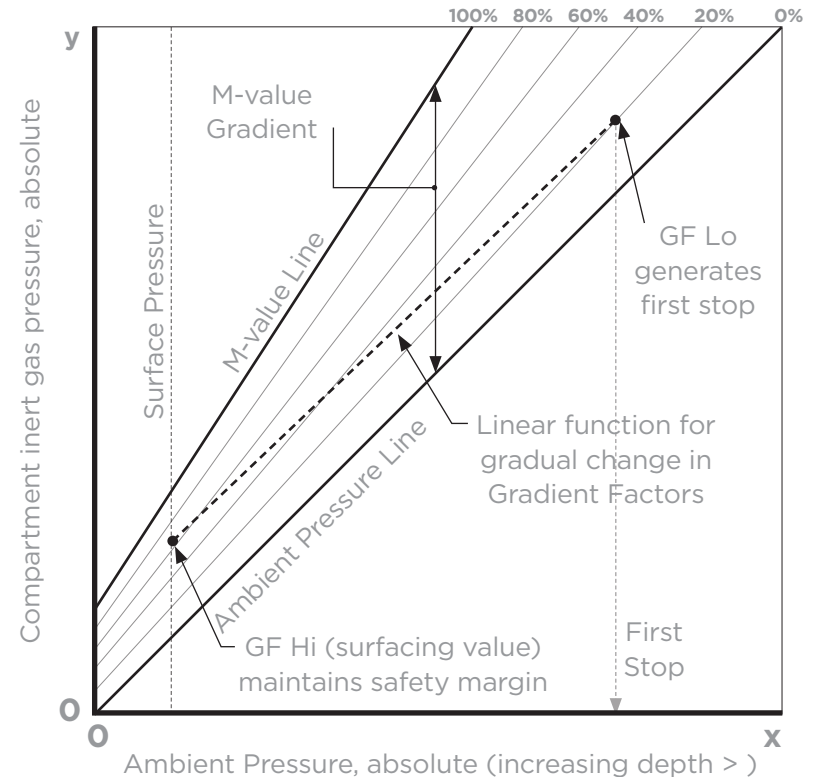

- A Gradient Factor is simply a decimal fraction (or percentage) of the M-value Gradient.
- Gradient Factors (GF) are defined from 0% to 100%.
- A Gradient Factor of 0% represents the ambient pressure line.
- A Gradient Factor of 100% represents the M-value line.
- Gradient Factors modify the original M-value equations for conservatism within the decompression zone.
- The lower Gradient Factor value (GF Lo) determines the depth of the first stop. Used to generate deep stops to the depth of the "deepest possible deco stop"
- The higher Gradient Factor value (GF Hi) determines the surfacing tissue supersaturation.



## 6.1. Decompression Information Accuracy

Decompression information displayed by this computer, including NDL, stop depth, stop time, and TTS are predictions. These values are continuously recalculated and will change with changing conditions. The accuracy of these predictions is dependent on several assumptions made by the decompression algorithm. It is important to understand these assumptions to ensure accurate decompression predictions.

It is assumed that the diver's ascent rate is 10m/min (33ft/min). Ascending significantly faster or slower than this will impact decompression obligations. It is also assumed that the diver is carrying and plans to use every gas that is currently turned on. Leaving gases that are not expected to be used turned on will result in inaccurate time to surface, decompression stop and decompression time information being displayed.

On ascent, it is assumed that the diver will perform decompression stops using the gas with the highest PPO<sub>2</sub> below the OC Deco PPO<sub>2</sub> value (default 1.61). If there is a better gas available, the current gas will be displayed in yellow, indicating that a gas change is expected. The decompression prediction displayed always assumes that the best gas will be used. Even if the switch to a better gas has not been completed yet, decompression predictions will be displayed as if the switch is about to occur in the next 5 seconds.

Divers can encounter longer than expected decompression stops as well as inaccurate time to surface predictions if they fail to switch to a better gas when prompted by the computer.

**Example:** A diver on a decompression dive to 40m/131ft for 40 minutes with GF settings of 45/85 has two gases programmed into their computer and turned on: 21% O<sub>2</sub> & 99% O<sub>2</sub>. The diver's decompression schedule will be calculated based on breathing 21% oxygen for the descent, bottom and ascent phases of the dive until the diver ascends to 6m/20ft. At 6m/20ft the PPO<sub>2</sub> of the 99% O<sub>2</sub> mix is 1.606 (less than 1.61), so it is the best decompression gas available.

Decompression information for the remaining stops will be calculated and displayed assuming the diver is going to switch to this better gas. This dive profile indicates these stops would be 8 minutes at 6m/20ft and 12 minutes at 3m/10ft. If the diver never makes the switch to 99% O<sub>2</sub>, the computer will not allow them to surface until adequate off-gassing has occurred, but it will continue to assume the diver is about to make the gas switch and the decompression times given will be grossly inaccurate. The 6m/20ft stop will take 19 minutes to clear and the 3m/10ft stop will take 38 minutes to clear. That is a total time to surface difference of 37 minutes.

In a lost gas scenario or in the event a diver forgets to turn off a gas they are not carrying before a dive, gases can be turned off during the dive in Dive Setup -> Define Gases.



## 7. Example Dives

### 7.1. Single Gas Example Dive

This is an example of displays that might be seen on a simple no-decompression dive in a single gas mode (Air or Nitrox).

1. Pre-Dive - This is the surface screen immediately before descending. At the surface, the battery is shown to be about 75% full. Air is the selected breathing gas. Maximum depth from the previous dive is displayed.

2. Descent - As we pass through 11 meters, NDL shows 99 minutes, the maximum no decompression limit that the computer will display during a dive. At this depth the safety stop counter will appear.

3. Max Depth - The NDL starts to show smaller numbers as depth increases. The 3rd screen shows that we will go into deco in 8 minutes. The safety stop counter has automatically increased to 5 minutes because the computer knows this is a deep dive.

4. Low NDL - When the NDL goes below 5 minutes, it turns yellow indicating that we should begin making our ascent to avoid a decompression obligation.

5. Ascent - As we ascend our NDL begins increasing again, indicating that we can stay a bit longer at this shallower depth. The ascent rate indicator shows that we are ascending at about 6 mpm or 22 fpm.

6. Safety Stop - When we ascend shallower than 6m, the safety stop counter will begin counting down. In this case the safety stop setting has been set to Adapt, and because of our deep profile, the countdown began at 5 minutes. A “Complete” indicator will inform us when the safety stop has been completed.

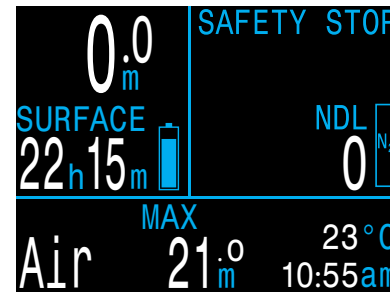

1. Pre-Dive



2. Descent



3. Max Depth



4. Low NDL



5. Ascent



6. Safety Stop



Although safety stops are not mandatory, when gas supplies permit, the best practice is to perform a safety stop on every dive.



## 7.2. Multi-Gas Example Dive

This is an example of displays that might be seen on a multi-gas decompression dive in 3GasNX Mode.

Max Depth: 40 meters	Bottom Gas: 28% O <sub>2</sub>
Bottom Time: 20 minutes	Deco Gas: 50% O <sub>2</sub>

1. Gas Setup - Best practices include checking your gas list before each dive. This screen is available in the Nitrox Gases section of the System Setup menu. All gases that are turned on will be used to calculate the decompression schedule. Turn off gases you are not carrying. Note that the MOD displayed on this screen will only impact the bottom gas (28% O<sub>2</sub>). Deco gases are governed by Deco PPO<sub>2</sub>.

2. Verify Decompression Settings - It is also prudent to ensure all other settings are correct before starting every dive. In addition to checking gases, we recommend verifying values in the Deco Setup menu.

3. Plan Dive - Use the decompression planner found in Dive Setup to check the total runtime, decompression scheduled and gas requirements for the dive with current settings.

The on-board deco planner is limited in functionality, so for complex dives we recommend using desktop or smartphone dive planning software.

4. Pre-Dive - Prior to beginning the dive we can see the active gas is currently set to 28% Nitrox and our battery is about three quarters charged.

5. Descent - As we descend our dive time begins counting and our NDL changes from zero to 99.

(Continued on next page)

### Nitrox Gases

#	On	O <sub>2</sub> %	MOD
▶ 1	Off	99%	6.3m
2	On	50%	23m
A3	On	28%	57m
MOD PPO <sub>2</sub>			1.4

1. Gas Setup

### Deco Setup

Buhlmann GF ZHL-16C	
Conservatism Custom	
GF	30/70
Last Stop	3m
Safety Stop	CntUp

2. Verify Deco Settings

OC	Depth	Time	RMV
	040	020	15
Stp	Tme	Run	Gas Qty
40	bot	20	28% 1419
21	asc	22	28% 115
12	asc	23	50% 36
12	1	24	50% 33
9	1	25	50% 29

3. Plan Dive - Deco Scheduled

OC	Depth	Time	RMV
	040	020	15
Gas Usage, in Liters			
50%: 287			
28%: 1534			

3. Plan Dive - Gas Requirement

0.0m	SAFETY STOP
SURFACE	NDL
45h 11m	0
Nx28	38.8m
MAX	23°C
	9:22am

4. Pre-Dive

11.0m	SAFETY STOP
TIME	NDL
1:35	99
Nx28	11.0m
MAX	21°C
	9:24am

5. Descent



## Multi-Gas Example Dive (cont.)

6. Max depth - Once NDL hits 0, deco stops will be needed. Stop requirements display in place of the Safety Stop information. TTS has increased to include deco stop time.

7. Ascent - It is safe to ascend to 12 meters. 1 minute must be spent at that deco stop. While ascending, the bar graph to the right of the depth shows the ascent rate (10 mpm). All decompression predictions are made assuming an ascent rate of 10 meters per minute.

8. Gas Change - All decompression predictions are made assuming you will switch to the best available gas on ascent. At 21m, the breathing gas turns yellow indicating that a better breathing gas is available. If the switch is not made, deco stop and time information will be inaccurate.

9. Approaching Deco Stop - As you ascend, the computer will notify you of an approaching deco stop. A green check will appear when within 1.8m deeper from the deco stop depth.

10. Missed Deco Stop - If you ascend shallower than the decompression ceiling the Deco information will flash red. If you fail to descend, a missed deco stop warning will be triggered. Acknowledge and clear the primary notification by pressing any button. Re-descend deeper than the stop depth to clear the flashing text.

10. Deco Clear - Once all decompression obligation has been cleared, the safety stop will begin if active. In this case deco clear counter begins counting up from zero.

End of example.

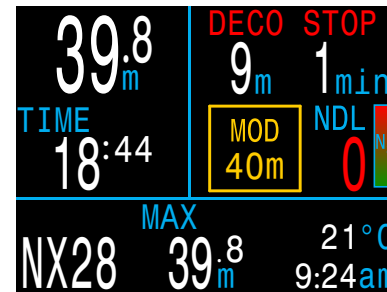

6. Max Depth

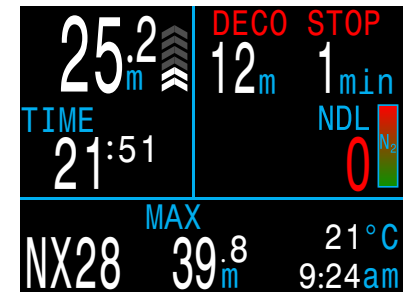

7. Ascent

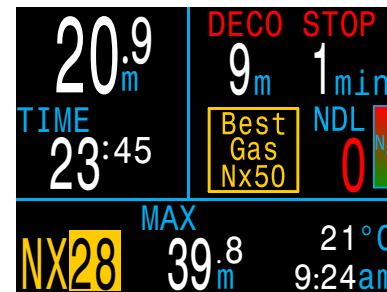

8. Gas Change

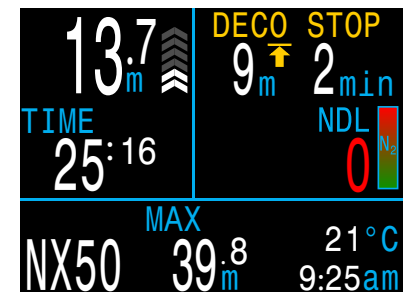

9. Approaching Deco Stop



10. Missed Deco Stop

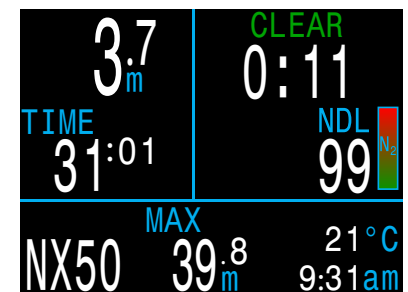

11. Deco Clear



## 7.3. Gauge Mode

Gauge Mode turns the Peregrine into a simple depth and time display (a.k.a. a bottom timer).

Gauge mode has a slightly different layout than other Peregrine modes.

While on the surface, the MAX and AVG values display the maximum and average depth of the last dive. The AVG depth displayed on the surface is for the entire dive, regardless of whether the reset average depth option was used. The dive log also records the average depth for the entire dive.

Gauge Mode Features:

- Resettable average depth
- Stopwatch



Since decompression tissues are not tracked in Gauge Mode, changing to or from Gauge Mode resets the deco tissues.

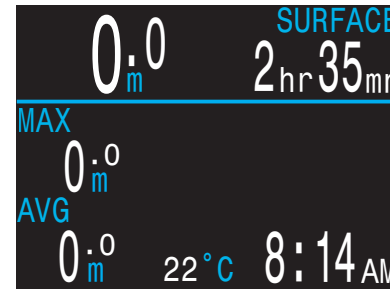

Gauge - Surface Display

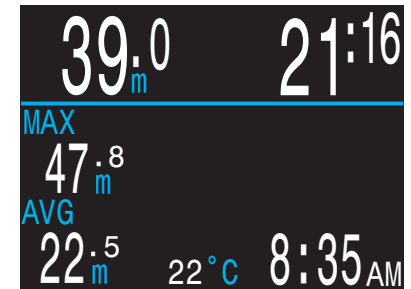

Gauge - Dive Display

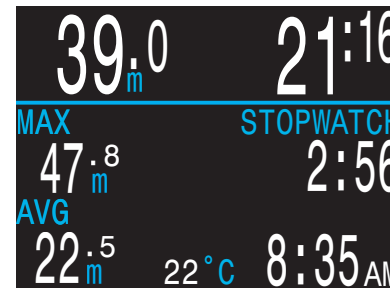

Stopwatch Running

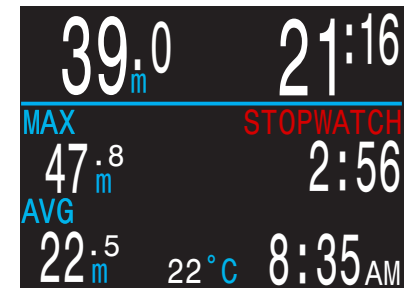

Stopwatch Stopped



## 8. Menus

Menus perform actions and allow settings to be changed.

If no buttons are pushed for 10 seconds, the menu system will time-out, returning to the main screen. Anything that had been previously saved will be retained. Anything that was in the middle of editing will be discarded.

The main Peregrine menu can be accessed using the menu (left) button from the main screen.

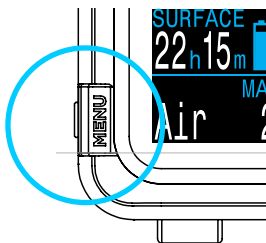

Main menu items differ by mode, as well as at the surface versus on a dive. The most commonly used menu items are placed first in the main menu to reduce button presses.

In the following section each item will be covered in detail.



### Adaptive Menus

Only menus necessary for the current mode are shown. This keeps operation simple, prevents mistakes, and reduces button presses.

## 8.1. Menu Structure

The following menu structure corresponds to the 3-Gas Nitrox mode. Other modes have less complex menus.

Some items are only available at the surface.

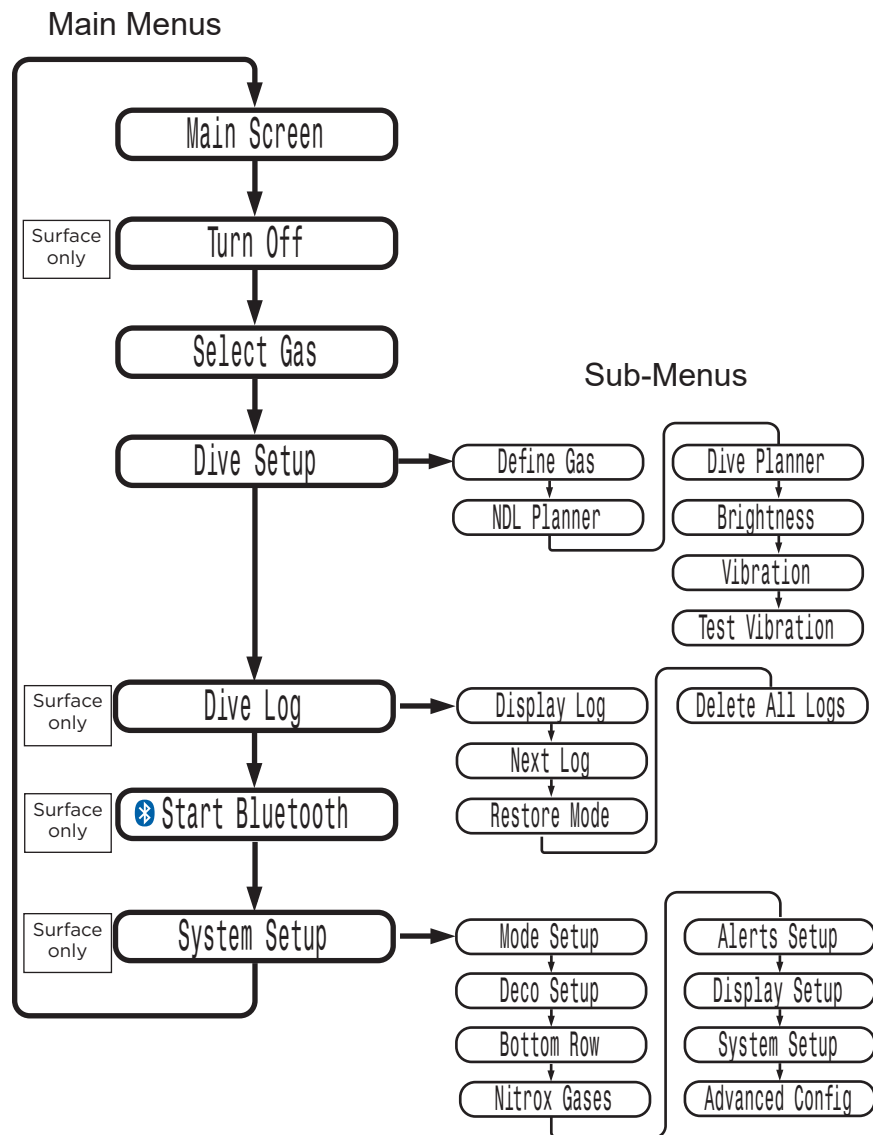



## 8.2. Turn off

The “Turn Off” item puts the computer to sleep. While sleeping, the screen is blank, but the tissue contents are maintained for repetitive diving. The “Turn Off” menu item will not appear during a dive. It will also not appear after a dive until the End Dive Delay Time has expired to allow for a continuation dive.

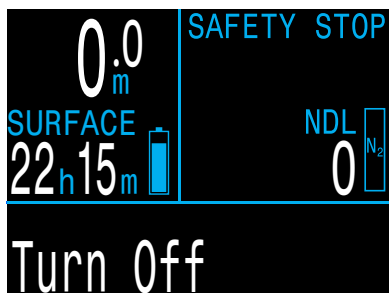

### End Dive

This menu item will replace Turn Off when on the surface and still in dive mode.

The Peregrine will automatically exit dive mode once 1 minute (default End Dive Delay setting) has been spent at the surface. Use this menu command to exit dive mode sooner.

Adjust the End Dive Delay in System Setup>Adv. Config. More information can be found on [page 42](#).

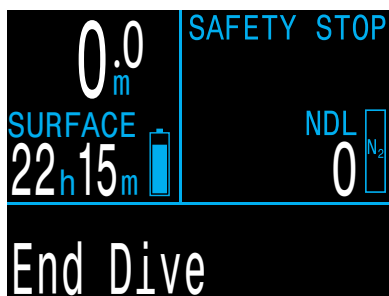

## 8.3. Select Gas (3 GasNx only)

This menu item allows you to pick a gas from the gases you have created.

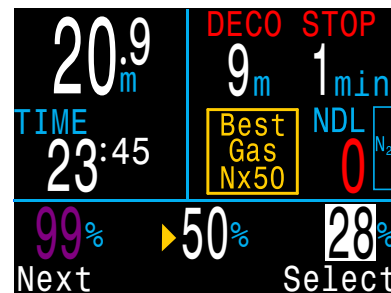

*Select Gas example:*  
 - 99% is turned off  
 - 28% is the active gas  
 - 50% is automatically queued for selection

Use the left (MENU) button to increment to the desired gas, then press the right (FUNC) button to select that gas.

The currently active gas is highlighted in white and an “Active” label will appear when you scroll over it.

A gas that is programmed, but off will be shown in **Magenta**. Currently off gases can still be selected. It will be turned on automatically if it is selected. Off gases are not used in decompression calculations.

When a gas change is suggested, the recommended best gas will be automatically queued up for selection when entering the Select Gas menu to minimize button presses.



### Gases will not turn off automatically

Selecting a new gas will turn that gas on if it is off, but gases will never turn off automatically.

It is important to turn off all gases you do not plan to use on the dive in the Define Gas menu to ensure you receive accurate decompression information.





## 8.4. Dive Setup

The sub-menus in Dive Setup are available both on the surface and while diving (unlike System Setup which is not available while diving).

### Define Gas

The Define Gas menu appears the same as the Select Gas menu, but allows turning gas on or off, and editing their oxygen percentage (the remaining percentage is assumed to be nitrogen).

In 3 GasNx mode gases may be edited and turned on or off during a dive.

In Nitrox mode Define Gas is found in the top level menu and the current gas can be edited on a dive.

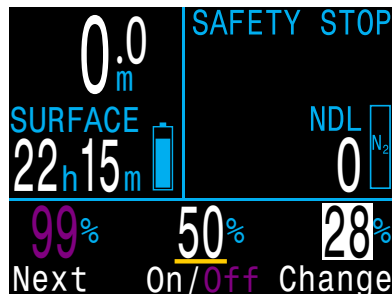

**Note:** The highlighted gas is the currently active gas. You can't turn off the active gas. You can edit it, but you will need switch gases to turn it off.



### Turn off gases you are not carrying

The decompression algorithm assumes that the diver is carrying and plans to use every gas that is currently turned on. Leaving gases that are not expected to be used turned on will result in inaccurate time to surface, decompression stop and decompression time information being displayed.

### NDL Planner

The No-Decompression Limit (NDL) Planner is a quick way to determine how much bottom time is available until mandatory decompression stops would be required.

#### NDL Planner

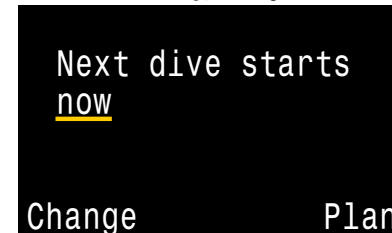

#### NDL Planner

DEPTH	NDL	Gas
12m	85min	Air
15m	49min	Air
18m	30min	Air
18m	21min	Air

Next Exit

A surface interval duration from none up to 1 day can be applied to account for expected off-gassing.

The results are a list of depths, along with the NDL time at that depth and the best of the programmed gases to use at that depth. Only programmed gases are used.



## Deco Planner (3 GasNx mode only)

### Introduction

- Calculates decompression profiles for simple dives.
- Calculates gas consumption based on RMV

The Peregrine's dive planner is best suited to decompression diving. For no-decompression diving, use the quick NDL Planner described on the previous page.

### Setup

The planner uses the current gases programmed in the current dive mode, as well as the current conservatism (GF low/high) settings.

### When used on the surface

Enter the expected surface interval, bottom depth, bottom time, and respiratory minute volume (RMV).

Note: Residual tissue loading (and CNS%) from recent dives will be used in calculating the profile

When the correct values are entered, select "Run Plan" and confirm decompression settings and starting CNS.

```

OC Depth Time RMV
  040 020 15
Enter Bottom Time
in minutes
Min: 5
Max: 180
Change Next
    
```

```

OC Depth Time RMV
  040 020 15
Ready to Plan Dive
GF: 30/70
Last Stop: 3m
Start CNS: 0%
Exit Plan
    
```

### When used during a dive

Computes the decompression profile assuming the ascent will begin immediately. There are no settings to enter. (RMV is last used value)



### Deco Planner Limitations

The Peregrine's Deco Planner is intended for simple dives.

Multi-level dives are not supported.

The Deco Planner does not provide thorough validation of the profile. For example, it does not check for nitrogen narcosis limitations, gas usage limitations, or CNS percentage violations.

The user is responsible for ensuring a safe profile is followed.



### Important!

The Peregrine's Deco Planner makes the following assumptions:

- Descent rate is 18m/min (60ft/min) and the ascent rate is 10m/min (33ft/min).
- The gas in use at any time will be the gas with the highest PPO2 within the PPO2 limits.
- The planner will use the configured last stop depth.
- The RMV is the same during the bottom phase of the dive as it is while traveling and during deco

[Read more about PPO2 Limits on page 43.](#)



### Results Screens

The results are given in tables showing:

Stp:	Stop Depth	In meters or feet
Tme	Stop Time	In minutes
Run	Run Time	In minutes
Gas	Gas Used	%O2
Qty	Quantity Used	In liters or Cuft

The first few rows will show the bottom time (bot) and the ascent time (asc) to ascend to the first stop. Multiple initial ascent legs may be shown if gas switches are needed

OC	Depth	Time	RMV		
	040	020	15		
Stp	Tme	Run	Gas	Qty	
40	bot	20	28%	1419	
21	asc	22	28%	115	
12	asc	23	50%	36	
12	1	24	50%	33	
9	1	25	50%	29	
Quit					Next

OC	Depth	Time	RMV		
	040	020	15		
Stp	Tme	Run	Gas	Qty	
6	3	28	50%	73	
3	6	34	50%	118	
Quit					Next

If more than 2 stops are needed, the results will be split onto several screens. Scroll down to step through the screens.

A summary screen shows the total dive time, the time spent on deco and final CNS% after the last page of the decompression schedule.

OC	Depth	Time	RMV
	040	020	15
Gas Usage, in Liters			
	50%:	287	
	28%:	1534	
Quit			Next

### Brightness

Change the brightness of the computer's screen.

The display brightness has four fixed brightness settings plus an Auto mode.

The fixed options are:

- 🔦 **Cave:** Longest battery life.
- 🔦 **Low:** Second longest battery life.
- 🔦 **Med:** Best mix of battery life and readability.
- 🔦 **High:** Easiest readability in bright sunlight.

Auto will use the light sensor to determine the brightness of the display. The more ambient light there is, the brighter the display will get. At depth, or in dark water, very little brightness is needed to see the display.

The Auto setting works well in most situations.

The brightness of the display is the major determinant of battery life. Up to 80% of the power consumption is to power the display. When battery is low, the maximum display brightness is automatically reduced to extend remaining operating time.





### Vibration

Quickly change the vibration function on or off.



### Test Vibration

Quickly test the vibration function to ensure it's working correctly.



 Regularly test vibration alerts with the Test Vibration tool to ensure they are working and you can hear/feel them through your exposure suit.

## 8.5. Dive Log

Use the Dive Log menu to review logs stored on the Peregrine. Up to 200 hours of detailed logs can be stored at the default sampling rate of 10 seconds.

The Dive Log menu is only available when on the surface.



### Display Log

Use this menu to display a list of logged dives and view details.

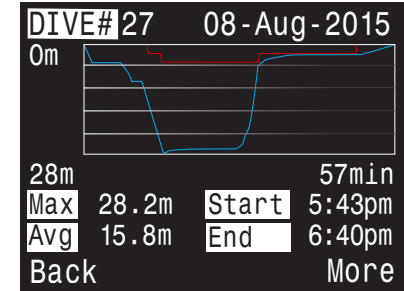
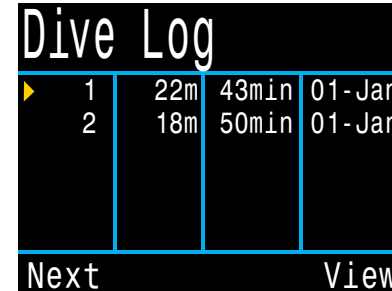

The profile of the dive is plotted in blue, with decompression stops plotted in red. The following information is displayed:

- Maximum and Average depth
- Dive number
- Date (dd-mon-yyyy)
- Start - Time of day dive started
- End - Time of day dive ended
- Length of dive in minutes
- Minimum, maximum, and average temperature
- Dive mode (Air, Nitrox, etc.)
- Surface interval preceding the dive
- Recorded Surface Pressure at the beginning of the dive
- Gradient factor settings used
- Start and end CNS

See the Dive Log functionality demonstrated on a Shearwater Petrel:





## Next Log

The dive log number can be edited. This is useful if you want the dive computer log numbers to match your lifetime dive count.

**Next Log = 0003**  
Next Edit

This number will be applied to the next dive.

## Restore Mode

Restore mode can be toggled on and off. When toggled on, it shows deleted logs, grayed out in the “Display Log” sub-menu. These dives can be restored to the Dive Log.

**Restore Mode Off**  
Next Edit

The Delete All Logs option is also changed to Restore All Logs when Restore mode is enabled.

## Delete All Logs

Deletes All of the Logs.

**Delete All Logs**  
Next Delete

Deleted Logs can be restored by toggling Restore Mode to on.

## Start Bluetooth

Bluetooth is used for both firmware uploading and dive log downloading.

 **Start Bluetooth**

Use this option to initialize Bluetooth on your dive computer.



## 9. System Setup Reference

System Setup contains configuration settings together in a convenient format for updating the configuration before a dive.

System setup cannot be accessed during a dive.

### 9.1. Mode Setup

The first sub-menu of System Setup is Mode Setup.

The appearance of this page changes slightly depending on the selected mode.

#### Dive Mode

There are 4 available dive modes:

- Air (default)
- Nitrox
- 3 GasNx
- Gauge  
(e.g. bottom timer mode)

Mode Setup	
Mode	Nitrox
Salinity	Salt
Gas O2%	32%
MOD PPO2	1.40
MOD =	57m
Next	Edit

When changing to or from Gauge Mode, the decompression tissues are cleared. This is because the Peregrine does not know what gas you are breathing in this mode, and therefore cannot track inert gas loading. Plan repetitive dives accordingly.

For more information on which mode to choose, see [Dive Mode Differentiation on page 9](#).

#### Salinity

Water type (salinity) affects how the measured pressure is converted to depth.

Settings:

- Fresh
- EN13319 (default)
- Salt

Density of freshwater and saltwater differ by about 3%. Saltwater, being denser, will display a shallower depth for the same measured pressure versus the Fresh setting.

The EN13319 value is between Fresh and Salt. It is from the European CE standard for dive computers, and is the Peregrine's default value.

Note that this setting only affects the depth displayed on the computer and has no impact on decompression calculations which rely on absolute pressure.

#### GAS O2%

In Nitrox mode, this is where the breathing Gas O2% is set.

In Air mode this setting is fixed at 21%.

In 3 GasNx mode, gases are setup in [Nitrox Gases on page 40](#).

#### MOD PPO2

In air and Nitrox mode, this is where you set the Maximum Operating Depth PPO2 of your breathing gas.

The Default is 1.4. Do Not change this value unless you are sure you know what you are doing.



## 9.2. Deco Setup

### Deco Model

In all modes this will show ZHL16C+GF indicating that the Bühlmann ZHL-16C with gradient factors model is being used.



### Conservatism

3 preset conservatism levels are available. In order of increasing conservatism:

- Low (45/95)
- Med (40/85)
- High (35/75)

Medium conservatism is the default setting.

A custom GF option is also available in every dive mode. If selected, GF Low and GF High fields will appear in the Deco Menu



**Do not Use a Custom GF if you don't understand the system.**

Using a custom GF without fully understanding the implication of the changes you are making could cause unexpected and potentially hazardous increases or decreases to decompression obligation.

For a more detailed explanation of the GF algorithm and the meaning of GF Low and GF High, please refer to Erik Baker's excellent articles: **Clearing Up The Confusion About "Deep Stops"** and **Understanding M-values**. The articles are readily available on the web.

Also see [Decompression and Gradient Factors on page 25.](#)

### Last Stop

Only configurable in 3 GasNx mode.

Allows you to choose where to do your last mandatory decompression stop.

The choices are 3m/10ft and 6m/20ft.

### Safety Stops

The Safety Stop setting can be set to the following values:

- Off
- 3 minutes
- 4 minutes
- 5 minutes
- Adapt
- CntUp (Count Up)

When using the Adapt setting, a 3 minute safety stop will be used, unless the dive exceeds 30m (100ft) or the NDL falls below 5 minutes. In these cases a 5 minute safety stop is used.

The Count Up setting will count up from zero starting from when you enter the safety stop zone or when decompression obligations are cleared.

[Read more about Safety Stops on page 23.](#)



### 9.3. Bottom Row

Configure and preview the bottom row in this menu.

The left position always displays the current gas.

The center and right positions are user configurable. For a complete list of configuration options, see [Configurable Info Row](#) on page 13.

Bottom Row			
▶ Center	GF99		
Right	SurGF		
Air	GF99	SurGF	
	15%	62%	
Change			Save

### 9.4. Nitrox Gases

This page is used to define up to 3 nitrox gases in the 3 GasNx dive mode.

Note that gases may also be edited (even during a dive) in the Dive Setup menu. However, the maximum operating depth PPO2 setting cannot be edited in Dive Setup.

Each gas can be set from 21% O2 to 99% O2. The remaining percentage is assumed to be nitrogen.

The active gas is shown with a leading 'A'. A gas that is turned off is drawn in magenta (purple).

The maximum operating depth (MOD) values are not editable directly and are only controlled by the MOD PPO2 value.

MOD PPO2 can be set from 1.0 to 1.69 in steps of 0.01.

Nitrox Gases			
#	On	O2%	MOD
▶ 1	Off	99%	6.3m
2	On	50%	23m
A3	On	28%	57m
MOD	PPO2		1.4
Next			Edit

### 9.5. Alerts Setup

This page is used to set up custom dive alerts for Maximum Depth, Time, and Low NDL. Notifications will be triggered when these values are exceeded.

You can also toggle the vibration function from this page.

See [Customizable Alerts](#) on page 21 for more information on how these alerts are displayed.

Alerts Setup		
Depth	On	m
Time	On	min
Low NDL	On	min
Vibration	On	
Next		Edit

### 9.6. Display Setup

#### Depth and Temperature

Depth: Feet or Meters

Temperature: °F or °C

#### Brightness

See brightness options on [page 35](#).

#### Altitude

The altitude setting on the Peregrine is fixed to Auto. This indicates that the computer will automatically compensate for pressure changes when diving at altitude.

#### Flip Screen

This function displays the contents of the screen upside down.

Display Setup	
▶ Depth Units	Meters
Temp Units	°C
Brightness	Auto
Altitude	Auto
Flip Screen	
Next	Edit





### Determination of Surface Pressure

Accurate depth measurements and decompression calculations require knowing the ambient atmospheric pressure at the surface. Regardless of the turn on method, the surface pressure is determined the same way. While in the off state the surface pressure is measured and saved every 15 seconds. A 10 minute history of these pressure samples is kept. Immediately after turn on this history is examined and the minimum pressure is used as the surface pressure. The surface pressure is then remembered, and not updated again until the next turn on.

## 9.7. System Setup

### Date

Allows the user to set the current date.

### Clock

Allows the user to set the current time. The format can be set to AM, PM or 24 hour time.

### Unlock

Only to be used at the direction of Shearwater technical support.

### Log Rate

Sets how often dive samples are added to the computer's log. More samples will give a higher resolution dive log at the expense of log memory. Default is 10 seconds. Maximum resolution is 2 seconds.

### Reset to Defaults

The final 'System Setup' option is 'Reset to Defaults'. This will reset all user changed options to factory settings and/or clear the tissues on the dive computer. 'Reset to Defaults' cannot be reversed.

**Note:** This will not delete dive logs, or reset dive log numbers.

System Setup	
▶ Date	8-Aug-2015
Clock	08:08AM
Unlock	
Log Rate	10 Sec
Reset to Defaults	
Next	Edit



## 9.8. Advanced Config

Advanced configuration contains items that will be used infrequently and can be ignored by most users. They provide more detailed configurations.

The first screen allows you to enter the advanced configuration area, or to set the advanced configurations settings to their default.

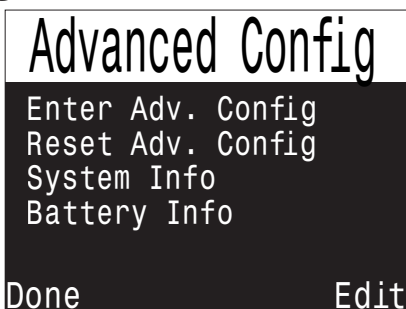

### System Info

The System Info section lists the computer's serial number as well as other technical information you may be asked to provide to tech support for troubleshooting purposes.

### Reset Adv. Config

This will reset all advanced config values to their default settings.

**Note:** This will not affect other computer settings, delete dive logs, or reset dive log numbers.

## Advanced Config 1

### Main Colour

Main colours can also be changed for added contrast. Default is white but can be changed to green or red.

### Title Colour

The title colors can be changed for added contrast or visual appeal. Default is Cyan, with gray, white, green, red, pink, and blue also available.

### End Dive Delay

Sets the time in seconds to wait after surfacing before ending the current dive.

This value can be set from 20 seconds to 600 seconds (10 minutes). Default is 60s.

This value can be set to a longer time if you want brief surface intervals connected together into one dive. Some instructors use a longer end dive delay when teaching courses. Alternatively, a shorter time can be used to exit dive mode more quickly upon surfacing.

### Battery Icon

The behavior of the battery icon can be changed here. Options are:

**Surf+Warn:** The battery icon always displays when on the surface. During dive it displays only if there is a low battery warning.

**Always:** The battery icon always displays.

**Warn Only:** The battery icon only appears when there is a low battery warning.

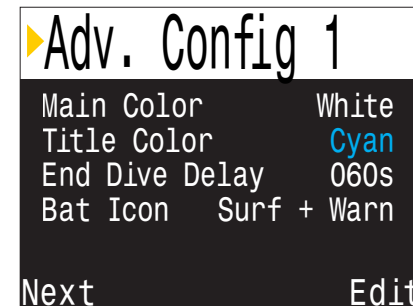



## Advanced Config 2

### PPO2 Limits

This section allows changing of PPO2 limits.



#### **WARNING**

Do not change these values unless you fully understand the effect.

All values are in absolute atmospheres [ATA] of pressure. (1 ATA = 1.013 Bar)

▶ Adv. Config 2		
OC Min.	PPO2	0.18
OC Mod.	PPO2	1.40
OC Deco	PPO2	1.61
Done		Edit

#### **OC Low PPO2**

PPO2 of all gases display in flashing red when less than this value. (Default 0.18)

#### **OC MOD PPO2**

This is the maximum allowable PPO2 during the bottom phase of the dive - **M**aximum **O**perating **D**epth. (Default 1.4)

This MOD setting is the same as can be edited in Mode Setup (for Air and Nitrox modes) and in the Nitrox Gases (for 3 GasNx mode).

#### **OC Deco PPO2**

All decompression predictions (Deco schedule and TTS) assume that the gas used for decompression at a given depth will be the gas with the highest PPO2 that is less than or equal to this value. (Default 1.61)

Suggested gas switches (when the current gas is displayed in yellow) are determined by this value. If you change this value, please be sure you understand its effect.

For example, if lowered to 1.50, then a switch to oxygen (99/00) will not be assumed at 6m/20ft.

### Bottom Gases Vs. Deco Gases

In Air only and Nitrox modes, all gasses are considered bottom gases and obey OC MOD PPO2 limit, even in decompression.

In 3 GasNx mode, the least oxygen rich mix is considered a bottom gas and obeys the OC MOD PPO2 limit. Other gases are considered deco gases and obey Deco PPO2 limit.



## 10. Firmware Update and Log Download

It is important to keep the firmware on your dive computer up to date. In addition to new features and improvements, firmware updates may address important bug fixes.

There are two ways to update the firmware on your Peregrine:

- 1) With Shearwater Cloud Desktop
- 2) With Shearwater Cloud Mobile



Upgrading the firmware resets decompression tissue loading. Plan repetitive dives accordingly.



During the update process, the screen may flicker or go blank for a few seconds

## 10.1. Shearwater Cloud Desktop

Ensure you have the most recent version of Shearwater Cloud Desktop. [You can get it here.](#)

### Connect to Shearwater Cloud Desktop

On your Peregrine, start Bluetooth by selecting the Bluetooth menu item from the main menu.

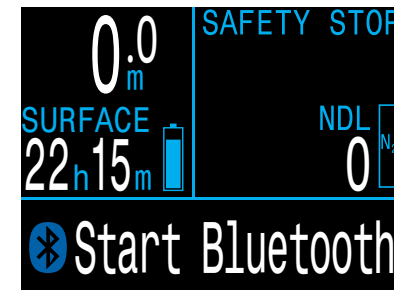

In Shearwater Cloud Desktop:

1. Click the connect icon to open the connect tab.
2. Scan for Dive Computer
3. Once you've connected the computer once, use the Peregrine tab to connect faster next time

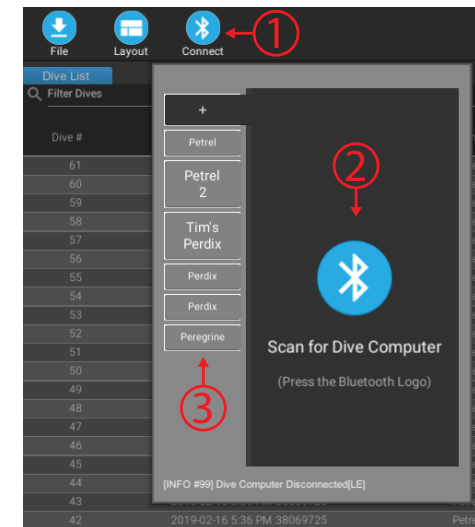

*Shearwater Cloud Desktop Connect Tab*



Once the Peregrine is connected, the connect tab will show a picture of the dive computer.

### Download Dives

Select “Download Dives” from the connect tab.

A list of dives will be displayed, and you can deselect any dive logs you don’t want to download, then press OK.

Shearwater Cloud Desktop will transfer the dives to your computer.

From the connect tab, you can give the Peregrine a name. If you have multiple Shearwater dive computers, you will be able to easily tell which dive was downloaded from which dive computer.

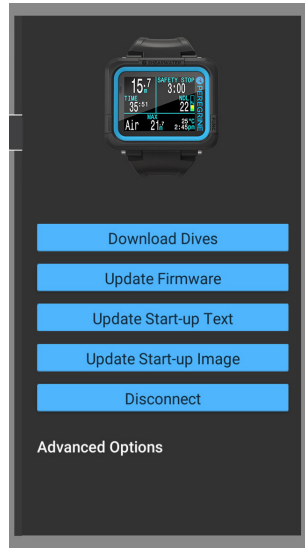

*Shearwater Cloud Desktop Connect Tab*



*Select the dives you wish to download and press OK*

### Update Firmware

Select “Update Firmware” from the connect tab.

Shearwater Cloud Desktop will automatically select the latest available firmware.

When prompted, select your language and confirm the update.

The Peregrine screen will give percentile updates of receiving the firmware, and then Shearwater cloud will read “Firmware successfully sent to the computer” on completion.



Firmware updates can take up to 15 minutes.

### Update Start-up Text

Start-Up text appears at the top of the start up splash screen when the Peregrine is turned on. It’s a great place to put your name and phone number so your computer can be more easily returned if mis-placed.

### Update Start-up Image

Here you can also change the startup image that appears when the Peregrine turns on to help better differentiate your dive computer.

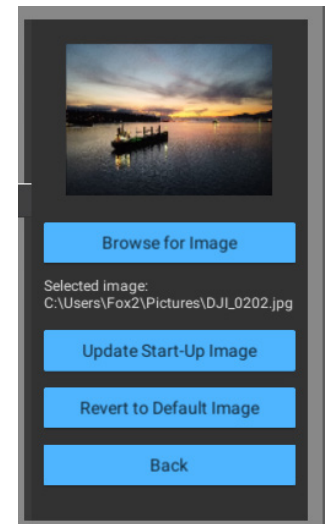

*Update Start-up Image*



## 10.2. Shearwater Cloud Mobile

Ensure you have the most recent version of Shearwater Cloud Mobile.

Download it from [Google Play](#) or the [Apple App Store](#).

### Connect to Shearwater Cloud Mobile

On your Peregrine, start Bluetooth by selecting the Bluetooth menu item from the main menu.

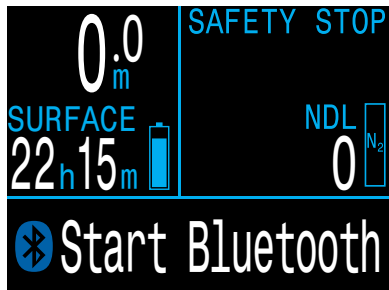

On Shearwater Cloud Mobile:

1. Press the connect icon at the bottom of the screen
2. Select your Peregrine from the list of Bluetooth devices

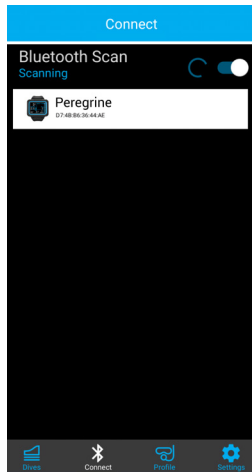

### Download Dives

Select “Download Dives”

A list of dives will be displayed and you can deselect any dive logs you don’t want to download, then press OK.

Shearwater Cloud will transfer the dives to your smart phone.

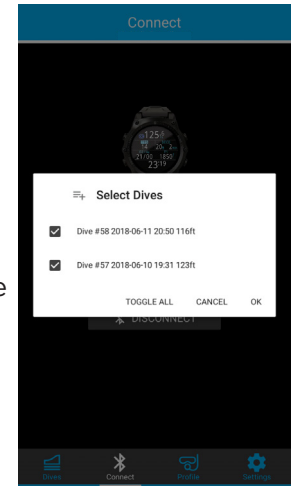

### Update Firmware

Once the Peregrine is connected to Shearwater Cloud Mobile, select “Update Firmware” from the connect tab.

Shearwater Cloud mobile will automatically select the latest available firmware.

When prompted, select your language and confirm the update.

The Peregrine screen will give percentile updates of receiving the firmware, and then the mobile app will read “Firmware successfully sent to the computer” on completion.



Firmware updates can take up to 15 minutes.



## 11. Charging

The Shearwater Peregrine charges wirelessly when mounted on the included dock and on some third party wireless Qi compliant chargers.

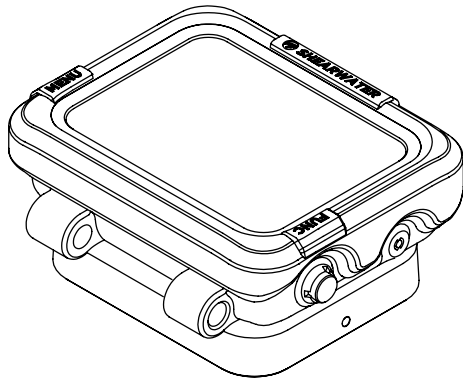

The screen will dim after 20 seconds, but pressing any button will wake up the Peregrine.

### Charger Positioning

Wireless chargers quickly lose efficiency when the transmission and receiver coils are not aligned properly or there is too large an air gap.

Ensure the Peregrine is flat against the charging dock for the fastest, most efficient charge.

If the Peregrine stops charging and the charger light begins to flash red, remove and replace the Peregrine and charging should resume.

### Battery Care

Lithium-ion batteries, such as the one in the Peregrine, can be damaged if completely discharged. The Peregrine has internal protection which disconnects the battery before complete discharge occurs. However, a small amount of self-discharge still occurs, which can lead to complete discharge and subsequent battery damage if stored for long periods without recharging.

To prevent damage to the battery please do the following:

- 1) Charge the Peregrine to 100% prior to storage
- 2) Top up the Peregrine battery every 3 months

### Charging time

The Peregrine can be charged with any USB wall power adapter or with a computer. Charging time is approximately 2 hours.



## Behavior on Dead battery

### Settings

All settings are retained permanently. No loss of settings occur if the battery dies.

### Clock

The clock (time and date) is saved to permanent memory every 16 seconds when the Peregrine is on, and every 5 minutes when off. When the battery dies, the clock stops running. Once the battery is charged, the clock is restored to the last saved value

You will need to update the Clock and Date in the System Setup Menu.

The Peregrine uses a quartz crystal oscillator for time keeping. Expected drift is about 4 minute per month. If you notice drift, it is can be corrected in the System Setup menu.

### Decompression tissue loading

If the battery dies between repetitive dives the decompression tissue loading will be lost.

Plan repetitive diving accordingly.

When deco tissues are reset, the following are also reset:

- Inert gas tissue loadings set to saturated with air at current atmospheric pressure
- CNS Oxygen Toxicity set to 0%
- Surface Interval time set to 0

## 12. Storage and Maintenance

The Peregrine dive computer should be stored dry and clean.

**Do not allow salt deposits to build up** on your dive computer. Rinse your computer with fresh water to remove salt and other contaminants.

**Do not wash under high pressure** jets of water as it may cause damage to the depth sensor.

**Do not use detergents or other cleaning chemicals** as they may damage the dive computer. Allow to dry naturally before storing.

Store the dive computer **out of direct sunlight** in a cool, dry and dust free environment. Avoid exposure to direct ultra-violet radiation and radiant heat.

## 13. Servicing

There are no user serviceable parts inside the Peregrine. Clean with water ONLY. Any solvents may damage the Peregrine dive computer.

Service of the Shearwater Peregrine may only be done at Shearwater Research, or by any of our authorized service centers.

Contact [Info@shearwater.com](mailto:Info@shearwater.com) for service requests.

Shearwater recommends service of your dive computer every 2 years by an authorized service center.

**Evidence of tampering will void your warranty.**





## 14. Glossary

**CNS** - Central Nervous System oxygen toxicity. Adverse physiological affects from prolonged exposure to an elevated partial pressure of oxygen.

**Deco** - Decompression. The state of requiring mandatory decompression stops or the act of performing those stops.

**NDL** - No-Decompression Limit. The time, in minutes, that can be spent at the current depth until mandatory decompression stops will be required.

**O<sub>2</sub>** - Oxygen gas.

**OC** - Open circuit. Scuba diving where gas is exhaled into the water (i.e. most diving).

**PPO<sub>2</sub>** - Partial Pressure of Oxygen, sometimes PPO2.

**TTS** - Time To Surface. The amount of time required to surface given an ascent rate of 10m/min, including all required mandatory decompression stops.



## 15. Peregrine Specifications

Specification	Peregrine
<b>Operating Modes</b>	Air Nitrox (Single Gas Nitrox) 3 GasNx (3 Gas Nitrox) Gauge
<b>Decompression Model</b>	Bühlmann ZHL-16C with GF (3 presets or custom GF low/high)
<b>Display</b>	Full Color, 2.2" LCD QVGA LCD with always on LED backlight
<b>Pressure (depth) sensor</b>	Piezo-resistive
<b>Crush Depth Limit (i.e. maximum rated depth)</b>	120 meters of seawater (msw) / 394 feet of seawater (fsw)
<b>Calibrated Range</b>	0.3 to 17 bar approx. +9000m altitude to 160 msw (525 fsw) depth Note: Exceeds crush rating of case Note: Depth sensor will not output values deeper than 160 msw (525 fsw)
<b>Accuracy</b>	+/- 20 millibar (at surface), about +/-0.2 msw +/- 50 millibar (at 120 msw), about +/- 0.5msw
<b>Surface Pressure Range</b>	500 mBar to 1040 mBar
<b>Operating Temperature Range</b>	0°C to +36°C
<b>Short-Term (hours) Temperature Range</b>	-10°C to +50°C

## Peregrine Specifications (cont.)

<b>Long-Term Storage Temperature Range</b>	+5°C to +20°C
<b>Charging Temperature Range</b>	+15°C to +25°C Charging outside this range may reduce the life of the battery or result in charging being paused to protect the battery
<b>Battery</b>	Rechargeable Lithium Ion battery Factory and service center replaceable
<b>Battery Operating Life</b>	30 hours (medium brightness) 3 months in Standby
<b>Communications</b>	Bluetooth Low Energy
<b>Dive Log Capacity</b>	Approx. 200 hour detailed log at 10s logging frequency.  2000 dive basic log
<b>Wrist Attachment</b>	Silicone band with stainless steel clasp Shock cord also included (hole diameter ø5.25 mm)
<b>Weight</b>	180g with silicone strap 125g computer only
<b>Size (W X L X H)</b>	77mm x 68mm x 25mm





## 16. Regulatory Information

### A) USA-Federal Communications Commission (FCC)

This equipment has been tested and found to comply with the limits for a Class B digital device, pursuant to Part 15 of FCC Rules. These limits are designed to provide reasonable protection against harmful interference in a residential installation. This equipment generates, uses, and can radiate radio frequency energy. If not installed and used in accordance with the instructions, it may cause harmful interference to radio communications. However, there is no guarantee that interference will not occur in a particular installation.

If this equipment does cause harmful interference to radio or television reception, which can be determined by tuning the equipment off and on, the user is encouraged to try and correct the interference by one or more of the following measures:

- Reorient or relocate the receiving antenna
- Increase the distance between the equipment and the receiver.
- Connect the equipment to outlet on a circuit different from that to which the receiver is connected.
- Consult the dealer or an experienced radio/TV technician for help.

Any changes or modifications not expressly approved by the party responsible for compliance could void the user's authority to operate the equipment.

#### Caution: Exposure to Radio Frequency Radiation.

This device must not be co-located or operating in conjunction with any other antenna or transmitter.

Peregrine Dive Computer Contains TX FCC ID: 2AA9B05

### B) Canada - Industry Canada (IC)

This device complies with RSS 210 of Industry Canada.

Operation is subject to the following two conditions:

- (1) this device may not cause interference, and
- (2) this device must accept any interference, including interference that may cause undesired operation of this device.

L'utilisation de ce dispositif est autorisée seulement aux conditions suivantes :

- (1) il ne doit pas produire d'interférence, et
- (2) l'utilisateur du dispositif doit être prêt à accepter toute interférence radioélectrique reçue, même si celle-ci est susceptible de compromettre le fonctionnement du dispositif.

#### Caution: Exposure to Radio Frequency Radiation.

The installer of this radio equipment must ensure that the antenna is located or pointed such that it does not emit RF field in excess of Health Canada limits for the general population; consult Safety Code 6, obtainable from Health Canada's [website](#).

Peregrine Dive Computer Contains TX IC: I2208A-05

### C) EU - European Union Directives

- Depth and time measurements conform with EN13319:2000 - Diving Accessories - depth gauges and combined depth and time monitoring devices
- Electromagnetic compatibility conforms with EN61000-6-3:2007+A1:2011 - Radiated Emissions and EN61000-6-1:2007 - Electromagnetic Immunity
- EU Declaration of Conformity is available at: <https://www.shearwater.com/iso-9001-2015-certified/>
- Shearwater EU Representative: Narked at 90 Ltd. +44.1933.681255 Northamptonshire, UK [info@narkedat90.com](mailto:info@narkedat90.com)

## 17. Contact

**Headquarters**  
13155 Delf Place, Unit 250  
Richmond, BC  
V6V 2A2  
Tel: +1.604.669.9958  
[info@shearwater.com](mailto:info@shearwater.com)

**US Service Center**  
**DIVE-Tronix, LLC.**  
Snohomish, WA, USA  
Tel: +1.858.775.4099  
[usaservice@shearwater.com](mailto:usaservice@shearwater.com)

**EU Service Center**  
**Narked at 90 Ltd**  
15 Bentley Court,  
Paterson Rd,  
Wellingborough,  
Northants, UK  
NN8 4BQ

Tel: +44.1933.681255  
[info@narkedat90.com](mailto:info@narkedat90.com)

**Asia/Pac Service Center**  
**Rob Edward**  
Wellington, NZ  
Tel: +64.21.61535378  
[asiapacservice@shearwater.com](mailto:asiapacservice@shearwater.com)

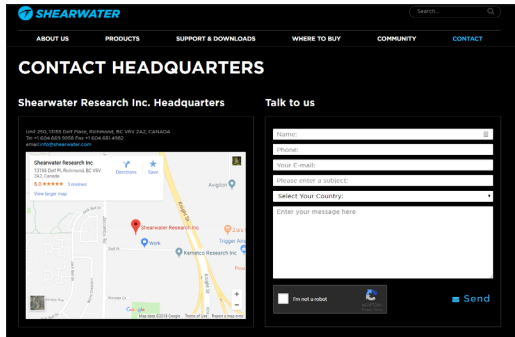

[www.shearwater.com](http://www.shearwater.com)

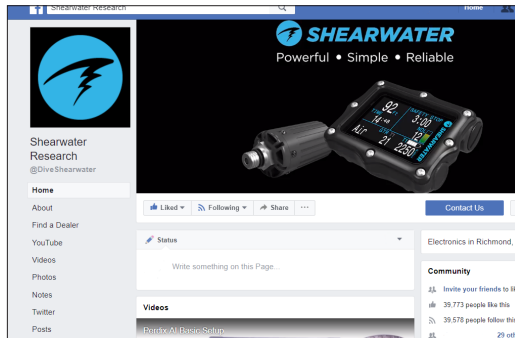

[www.facebook.com/DiveShearwater](http://www.facebook.com/DiveShearwater)

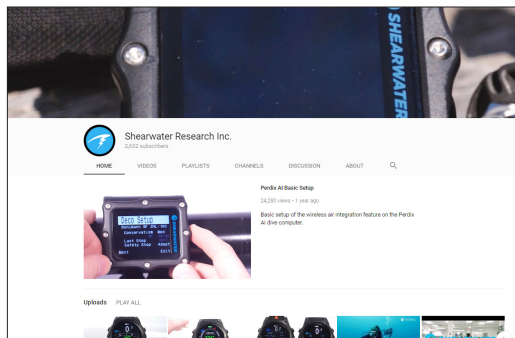

[www.youtube.com/shearwaterresearch](http://www.youtube.com/shearwaterresearch)