



help@azdome.hk

Response in just 6 hours



WhatsApp Contact

Scan or upload this QR code using
the WhatsApp camera to add me on
WhatsApp

KAKA GROUP LTD

www.azdome.hk help@azdome.hk

Address : 1801-1808, HaiYun Building, No. 468, Minzhi Avenue,
Longhua New District, Shenzhen, China. 518000, CN



V2.0

Owner's Manual

M17

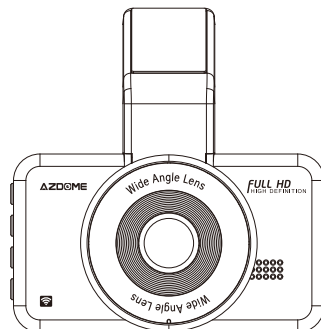

AZDOME

●> **CUSTOMER SERVICE**

***Item NOT as described?

***Damaged or defective?

***Missing items?

***Any issues what so ever?



help@azdome.hk

Response in just 6 hours

Contact us before returning the item.
We will help you resolve any issues asap.



Scan or upload this QR code using
the WhatsApp camera to add me on
WhatsApp



●» INDEX

1. Warranty & Introduction	02
2. Product Sepcification	04
3. Product Diagram	05
4. Button Controls	06
5. Get Started	07
6. Using Your Dash Cam	09
7. Using Wifi Feature	12
8. Function Description	15
9. FAQ	19
10. Disclaimer	21
11. Notice	22

●» 1.WARRANTY&CUSTOMERSUPPORT

We provide 12-Month of limited warranty for your product from the date of purchase to be free from defects in materials and craftsmanship. For questions, support, or warranty claims, contact us at help@azdome.hk with you Order Number.

*IMPORTANT: Proof of original purchase (Online order receipt is also accepted) is required for any warranty service. AZDOME can only provide after sales service for products purchased directly from AZDOME. If you have purchased from a different seller, please contact them directly for service or warranty issues.



help@azdome.hk

Please scan the QR code to get Online User Manual.



Experience Safety With AZDOME Car Camera

The car camera is a small HD camera which is situated near the windscreen of the car and it records the road ahead of the driver. With an extensive increase in the number of vehicles, it is very important to have a vast idea of the vehicles around, in order to prevent any kind of mishap. AZDOME camera helps the driver in parking the vehicle by the motion sensor technology. The recording of the camera starts as soon as the engine roars to power and automatically gets switched off when the car stops. These car cameras not only help the driver by providing them with the side-lane views but also record throughout the journey, and this recording can be accessed anytime.

AZDOME Camera - Giving a New Meaning To Security

With the built-in Wi-Fi function and the free AZDOME app, you can view real-time videos on your iPhone or Android device while on the drive. Also, view and share recorded videos with friends and family in just a few clicks, via the AZDOME application. Moreover, any tampering activity can not only be recorded but can also be captured in still photography. The car cameras are competent enough to take qualitative pictures and these pictures can be extracted anyway with the help of memory card.

2. Product Specification

Model	M17
Screen Size	3.0 Inch
Lens	150°wide angle lens
Lens Aperture	F=2.0
Video Code	H.264, MOV
Video Resolution	1080P 1920x1080/720P 1280x720
Video Effective Pixel	2 Mega Pixels
Photo format	JPG
Photo resolution	2M/5M/8M/12M
Photo Effective Pixel	12 Mega Pixels
Language	English, French, Deutsch, Spanish, Italian, Japanese, Russian, Dutch, Polish, Chinese
Memory Card	Micro SD Card Class 10 or Higher, Max Support 128 GB (Micro SD Card NOT Included – Required for camera operation)
G-sensor	Built-in 3-Axis Impact Accelerometer Gravitational Sensor to lock & protect current video.
Frequency	60 Hz, 50 Hz
WiFi	Support, please download APP “AZDOME”
Loop Recording	Support
Parking Mode	Support
Fatigue Driving Reminder	Support

Record Audio	Support
Mini-USB port	Charging
Power Interface	5V 1.5A
Battery	Built-in Li-ion Battery 200mAh
Operating Temperature	-20°C to 70°C (-4°F to 158°F)
Working Humidity	10 ~ 90%

◆ 3. Product Diagram

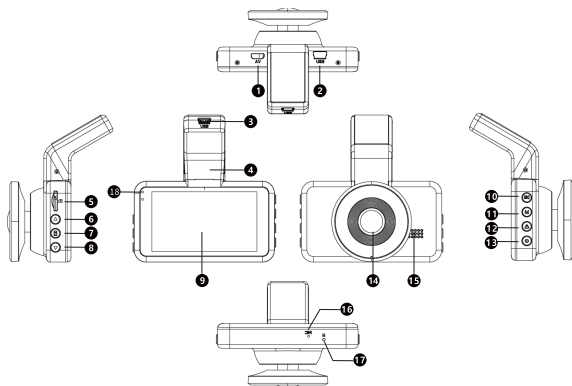

- ① Micro AV IN (For 5PIN VGA Rear Camera, Not Recommended)
- ② USB Charging Port 1
- ③ USB Charging Port 2
- ④ Bracket
- ⑤ TF Card Slot
- ⑥ Up Button
- ⑦ Menu Button
- ⑧ Down Button
- ⑨ Screen
- ⑩ OK/Record Button

- ⑪ Mode Button
- ⑫ Lock Button
- ⑬ Power Button
- ⑭ Lens
- ⑮ Speaker
- ⑯ Microphone
- ⑰ Reset Button
- ⑱ Red Light: Charging Status Indicator
Green Light: Working Status Indicator

◆ 4. Button Controls

Button	Operation and Function
▲	1. Select function options in setup mode 2. Select previous video in playback mode
☰	Press once to enter menu setting (Disabled in recording mode)
▼	1. Select function options in setup mode 2. Select next video in playback mode
OK	1. In recording mode, press once to start recording, press one more time to stop recording. 2. Long press once to shoot photos when recording. 3. Press once to confirm your setting in settings mode.
M	1. Press once to shift between Video / Photo / Lock Video playback mode. 2. Press once to return to previous page in playback mode.
🔒	In recording mode, press once to lock the video as an emergency one.
🔌	1. Press once to turn on the device 2. Press once to lock the screen 3. Press and hold to turn off the device
Reset	Reboot the device and default settings

5. Get Started

Install the Memory Card

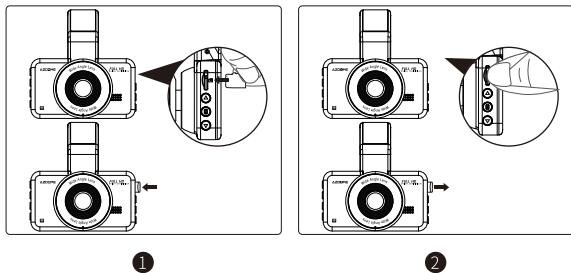

1. Insert a card with the golden contacts facing the LCD display side of the dash cam.
2. To remove the card, gently push it until it clicks and pull it out of the slot.

Note:

1. Do not insert or remove the TF card when the dash cam is powered on to avoid breakage of the card.
2. Please use a class 10 micro SD card from 16 GB to 128 GB.
3. Format the memory card before use.

Format the Memory Card

1. Press  to enter setting interface.
2. Press  to locate Micro SD card set up, press  to enter Micro SD card format.

3. Press  to locate "OK", press  to confirm formatting.

Dash Cam Installation

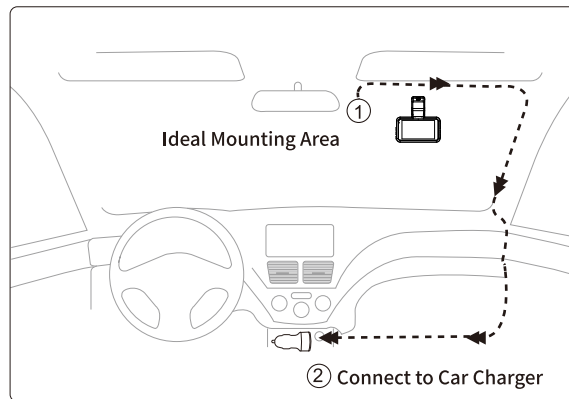

1. Slide the mount into the mount installation slot.
2. Turn off the car engine.
3. Stick the car mount together with the camera onto your windshield.
4. Connect the USB charging cable to the mini USB port of the dash cam. Run the cable along the edge of the windshield. Tuck away in the seams and extend it all the way to the USB port of the car charger. Be sure to keep it away from the airbag area.
5. Adjust the dash cam to keep the lens level with the ground.
6. Start the engine to check if the dash cam works properly.

Note:

1. Only use the supplied Car Charger, otherwise the camera may frequently reboot or flicker LCD due to insufficient power.
2. Make sure to remove the Plastic Lens Screen Protector from the lens before recording videos. Otherwise your videos will look blurry and blocked.
3. 200mAh battery is mainly used to save files in emergency. Please always connect Dash Cam to external power while using.

●» 6. Using Your Dash Cam

1. Auto Power ON/OFF:

- ① Connect the car charger and Dash Cam by using the charging cable.
- ② Plug the other end of the car charger to your vehicle's cigarette lighter socket.
- ③ When the car engine is on, dash cam will turn ON and start recording automatically. When the car key is turned to LOCK position, Dash Cam automatically saves the recording and turns OFF within few seconds.

Note:

Some trucks/car's 12V cigarette outlet is always HOT, which means it provides constant power even when the car is turned OFF and LOCKED. If this is the case for your vehicle, then the auto ON/OFF feature will not work. And if you leave the camera continuously recording when the car is turned off, then it will drain your car/truck's battery and you might not have enough power to start your car for next time. To Remedy this situation,

you can do one of the two options.

- *Hardwire your dash cam to your car's fuse box with AZDOME'S 2-Lead Auto Trigger Hardwire Kit.
- *Change the connection in the fuse box for your 12V outlet to socket which only supplies power when car key is turned to ACC or ON position.





2. Manual Power ON/OFF

- To Manually Turn ON: Press the power button once.
- To Manually Turn OFF: Press and hold the power button for at least 2 seconds.

3. Format The Memory Card

1. Press  to enter setting interface.
2. Press  to locate Micro SD card set up, press to enter Micro SD card format.
3. Press  to locate "OK", press  to confirm formatting.

4. Menu Setting

1. Press  to enter menu setting.
2. Press  to locate the item you want to set.
3. Press  to confirm your setting.
4. Press  again to exit menu setting.

Note: Please set the right time before using the dash cam.

5. Playback Mode

Press  to shift between Video / Photo / Lock Video playback mode.

5.1 Video Playback

1. Press ▲ / ▼ to select files.
2. Press ≡ to delete selected file.
3. Press OK to play / pause the selected file. Press and hold ▲ / ▼ to fast-forward / rewind.
4. Press M one more time to exit video playback.

5.2 Photo Playback

1. Press ▲ / ▼ to select files.
2. Press ≡ to delete selected file.
3. Press OK to view the selected file.
4. Press M one more time to exit photo playback.

5.3 Lock Video Playback

1. Press ▲ / ▼ to select files.
2. Press OK to play / pause the selected file. Press and hold ▲ / ▼ to fast-forward / rewind.
3. Press M one more time to exit video playback.

Note: Cannot delete protected files on the dash cam.

7. Using Wifi Feature

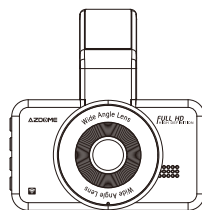

What is a WiFi Feature?

The WiFi feature has been designed so you can pair your dash camera wirelessly with your smartphone and access your recording instantly from the dash cam. Here you can view, download and share your videos easily with your friends and family. Just like how you would connect your Bluetooth speaker to your smartphone for wireless music play, the same way dash cameras use WiFi signal (instead of a Bluetooth) to pair your smartphone with AZDOME M17.

What is the WiFi Range?

The WiFi signal range is about 10FT when there are NO obstructions in the middle. Please NOTE that just like your home WiFi network, you can't have WiFi signal outside your home, the same way, WiFi range is 10FT from this small device.

Can I watch the videos or surveillance around my car remotely?

NO. AZDOME M17 dash cam is NOT made to broadcast footage over the cloud or internet. It is NOT a cloud or an IP camera and it is NOT meant to do that. You can get live video and footage on AZDOME M17's APP as long as you stay within the 10FT range from the dash cam.

Downloading AZDOME App On phone

1. Search for "AZDOME" in App Store or Google Play Store to find the App and then download and install it.
2. Turn on WiFi of your phone and connect: Go to Phone's Settings > WiFi > Select WiFi of the camera (WiFi Name SSID: M17_*****, PASSWORD: 12345678).
3. Open the AZDOME App to Click << Check Real-time Video >> you will see the live video of dash cam on the AZDOME App when connect successfully. Then keep exploring the APP from here on.

Please NOTE:

1. You have to choose <<WLAN>> in the settings of AZDOME APP: Settings → Scroll down to find and click <<AZDOME >> → Click << Wireless Data >> → Select <<WLAN>>.
Or you have to turn off <<Cellular Data>> in the settings of AZDOME APP: Settings → Scroll down to find and click <<AZDOME >> → turn off <<Cellular Data>>.
- You can also try to turn off cellular service directly and try connecting to the camera again.
2. You can't operate the dash cam when connecting WiFi.
3. Please keep you dash cam to your phone within 10FT.

Scan the QR code to get the whole process about WiFi



For Android phones:

There is one extra step you will have to take for the first time.

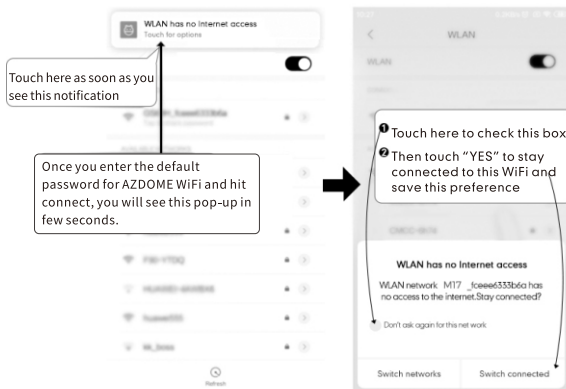

For iPhone:

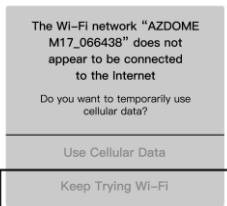

If you get this pop up for your iPhone while using WiFi feature, make sure to tap on "Keep Trying WiFi". Otherwise the camera will get disconnected from the WiFi and then you will have to forget the AZDOME WiFi and then start to pair again for it work again.

●» 8. Function Description

Movie Mode—FHD 30fps(Default)/HD 30fps

Allow to choose the desired video resolution and fps(frames per second). Higher resolution and fps videos result in smoother videos, but also take more storage space.

Loop Recording— Off/1min/ 3mins(Default)/ 5mins

Allow the dash-cam to continuously record. Please notice: the dashcam will keep deleting the oldest files automatically when memory card gets full so that it can keep recording over and over. Here select the length of video file for the loop recording.

Sound Record—On(Default)/Off

On: The video file will have sound.
Off: The video file will have no sound.

Exposure

To adjust video exposure setting for either brighter or darker video according to your preference.

Video Time Lapse—Off(Default)/On

On: The dash cam can sustain longer operational period while reducing video file size. Video files will be played at high-speed when playback.

ADAS—On/ Off(Default)

ADAS-On/Off(Default)

To use ADAS function:

1. Turn on ADAS in the menu setting, enter the ADAS mode.
2. On a straight road, gently adjust the front lens so that the two green lines coincide with the road. The cross icon is placed in the middle of the road. When the blue lines coincide with the road and the green lines disappear, the calibration is successful.

Note:

ADAS is only an auxiliary function, the accuracy rate can only reach 90% at most, and the accuracy will decrease at rainy days, evenings, or on complex road scenes. It is recommended to calibrate once every other time or when the accuracy of ADAS broadcast is low.

G-Sensor-Off/Low(Default)/Middle/High

G-sensor is a 3-axis impact gravitational accelerometer, designed to detect physical and gravitational forces on the dash cam. Once Gsensor has triggered due to physical or gravitational impact force on the camera, the current video file will be locked as an emergency file so it won't be deleted by loop cycle function.

Parking Monitoring — On/ Off(Default)

Designed to work when dash cam is shaken during HIT&RUN event while your car is parked. Based on G-sensor setting, when your car gets hit and shaken, the dash-cam will turn on automatically, and start recording for 1min on internal battery, then lock that video file before automatically turn-off, so the video file won't be erased by loop recording function. While you use the dash cam and the car is running, please turn OFF this function, otherwise the dash cam will automatically turn on and off randomly.

Please NOTE:

The internal battery can provide power up to 2-3mins when it is fully charged. If you want 24h monitoring, you can use one AZDOME2-Lead Hardwire Kit to connect the dash cam to your car battery (Hardwire kit not included in the package).

Language — Multilingual, default English.

Allow to choose your desired language for dash-cam system.

Volume — Off/ High(Default)/ Middle/ Low

To switch on/ off or adjust the beep sound.

LCD Power Save — Off(Default)/1min/ 2mins/ 3mins

Once chose a time duration and turned on this function, the dashcam will automatically show a black background after the set time, while the camera still stays ON. Please notice that this function only turns off the LCD screen, to prevent from distracting the driver.

Power Save — Off(Default)/1min/ 2mins/ 3mins

Once chose a time duration and turned on this function, when the camera will stay idle, it will automatically turn off.

Frequency — 50HZ/ 60HZ(Default)

According to the power supply specification used in your country.
Frequency-60HZ-Used in USA, North America
Frequency-50HZ-Used in Europe, most Asian Countries.

Date/Time

Set your local date and time.

Date/Time Stamp — On(Default)/Off

On: The recording time will be shown on the video or photo.

Fitigue Warn — Off(Default)/1 hour/2hours/4hours

1/2/4Hour(s): The dashcam will make sound when dashcam working for 1/2/4 hours. To alert that please keep awake.

Format SD Warn — Off/15days/30days(Default)/60days

The dashcam will alert that please format SD card, if too much emergency lock file to use loop recording function.

Format SD Card — OK/Cancel

Allow to format the inserted memory card, all data will be deleted.

Default Settings

Allow to restore all settings to factory default settings

Firmware Version

To check the current firmware in the dashcam. You'll need this necessary information to check if newer version firmware is available to update. Please visit

<http://www.azdome.hk/downloads.html> for the latest firmware. Or please contact us by email: **help@azdome.hk**

●» 9. FAQ

Q1: Camera does not turn ON?

1. Use the Mini USB Cable and your smart phone's USB charger. Now plug it into your home's 110V wall outlet.
2. When you plug it in, the camera should turn ON. If NOT, then press the Power Button Once to see if it turns ON? If it still does NOT turn ON, then remove the memory card.
3. Keep the camera plugged in. Now Press the RESET button (Located at the bottom) ONCE with a pen's tip or a paper clip. Now the camera should turn ON. If it still doesn't turn ON, then please CONTACT US.

Q2: Camera turns ON / OFF frequently automatically?

Please reset your camera. Try updating the firmware again to

see if this fixes the issue. If still having issue, please reach out to customer care.

Q3: Error/Message “Card Full”

Format card by going into system settings > format > OK > Select Format > OK. Then Go to Video Mode settings > Loop Recording > Choose either 1-min, 3-min, 5-min. This will allow loop cycle function to be turn ON and it will keep recording over and over.

NOTE: Formatting will delete all the data from the memory card.

Q4: My oldest video files are missing?

Your AZDOME Dash Cam has Loop Cycle Recording. When it is set to either 1, 3 or 5-mins, it will delete oldest files and record newer files over and over when the memory card is full.

To test again: Set the date and time correctly, then FORMAT the memory card, then do the continuous recording test again and check if all videos are present.

Q5: Camera gets HOT?

It is normal for your camera to run slightly hot. Due to it is recording video at high speed, the dash cam may be hot during using. (no more than 158°F/70°C).

Q6: Video is fuzzy?

Please make sure the lens of the camera is clean and there is no dirt or grease on the windshield also. If the lens is out of focus, we are extremely sorry in advance. This can be a manufacturing defect. Please send us an email with a screenshot or a sample

video so we can get this resolved for you ASAP.

Q7: Camera Locks many videos automatically?

Please make sure you change your G-sensor setting. If you choose higher setting then it can trigger even with smaller bump. This setting depends on type of car or truck you are driving and how much vibration your car/truck is creating based on suspensions and road condition.

Q8: Camera showing "Memory Error"?

1. Please make sure memory card is at least Class 10, U3 and purchased from trusted vendor such as Walmart, target, best buy, Ship & Sold by Amazon" etc. (there are many fake cards out there Online, remember if it's cheap, its fake.)
2. Now go to camera's system settings and FORMAT your memory card. (make sure to backup your videos first before formatting the memory card.) After formatting memory card, please press and hold power button to turn the camera off. Now unplug power cable, and re-plug the power cable, camera should now turn ON automatically and start recording.
3. If you still get the same memory card error message, your camera's memory card assembly has become defective. Please contact us by email help@azdome.hk.

10. Disclaimer

The videos/pictures taken by Car dash cam is only for a reference, we don't take any responsibility due to data-loss in the abnormal circumstances. Special version: The device will records files in normal recording status. But in the following

situation, it will lead to files to be damaged or lost;

1. If pulling out the TF card in the recording status, final video files will be damaged or lost.
2. If there is illegal blackout in the recording status, final video files will be damaged or lost.
3. If there is a destructive collision in the recording status, video and audio files will be damaged or lost.
4. If there is a destructive collision in the recording status leading to Memory card loose, video and audio files will be damaged or lost.

11. Notice

 This product complies with the radio interface requirements of the European Community.

 This symbol means the product must not be discarded as household waste, and should be delivered to an appropriate and recycling helps protect natural resources, human health and the environment. For more information on disposal and recycling of this product, contact your local municipality, disposal service, or the shop where you bought this product.

 Changes or modifications not expressly approved by the party responsible for compliance could void the user's authority to operate the equipment.

This equipment has been tested and found to comply with the limits for a Class B digital device, pursuant to Part 15 of the FCC Rules. These limits are designed to provide reasonable protection against harmful interference in a residential installation. This equipment generates, uses and can radiate

radio frequency energy and, if not installed and used in accordance with the instructions, may cause harmful interference to radio communications. However, there is no guarantee that interference will not occur in a particular installation.

If this equipment does cause harmful interference to radio or television reception, which can be determined by turning the equipment off and on, the user is encouraged to try to correct the interference by one or more of the following measures:

- Reorient or relocate the receiving antenna.
- Increase the separation between the equipment and receiver.
- Connect the equipment into an outlet on a circuit different from that to which the receiver is connected.
- Consult the dealer or an experienced radio/TV technician for help.

This device complies with Part 15 of the FCC Rules.

Operation is subject to the following two conditions: (1) this device may not cause harmful interference, and (2) this device must accept any interference received, including interference that may cause undesired operation.

This equipment complies with FCC radiation exposure limits set forth for an uncontrolled environment. This equipment should be installed and operated with a minimum distance of 20cm between the radiator & your body. This transmitter must not be co-located or operating in conjunction with any other antenna or transmitter.