

---

SUNSTRUCTION  
**DAKHAKEN**  
**LANDSCAPE**  
**HANDLEIDING**

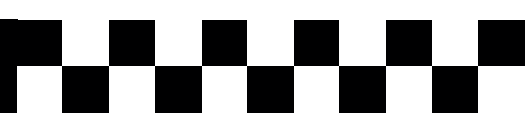

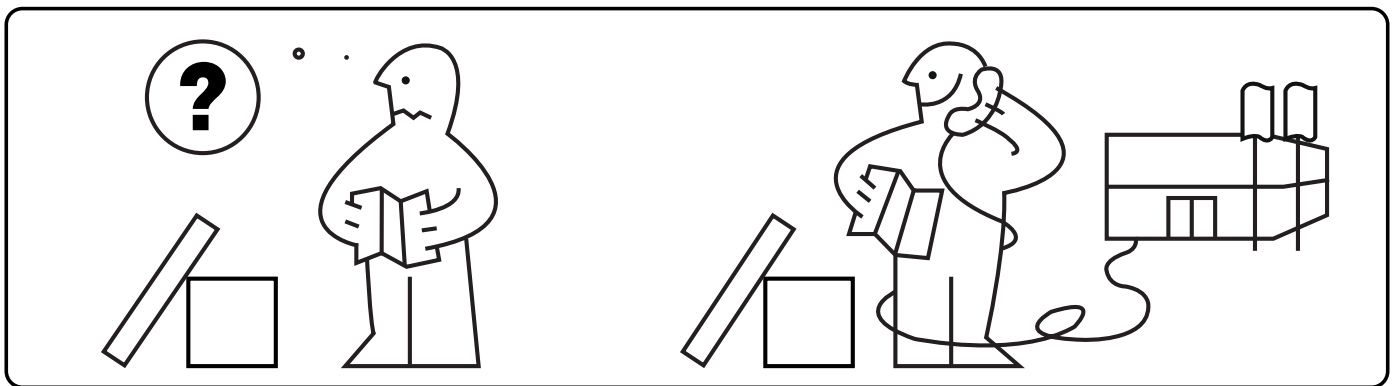
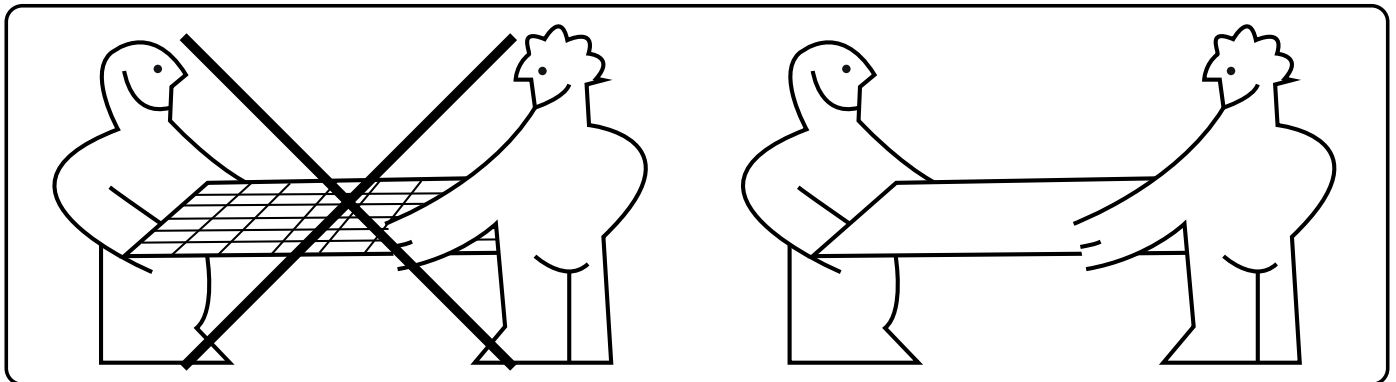
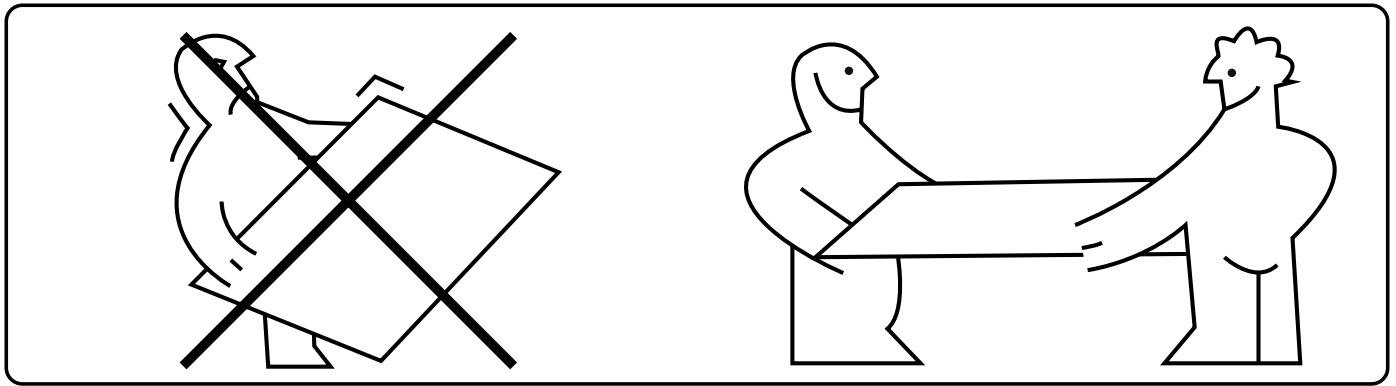
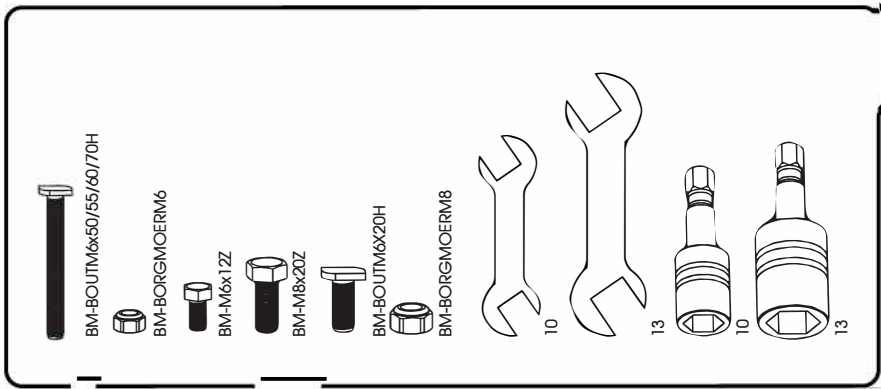

SP



AO-DH



AO-S PK OR PEL



AO-TK



AO-EK



AO-HL

1

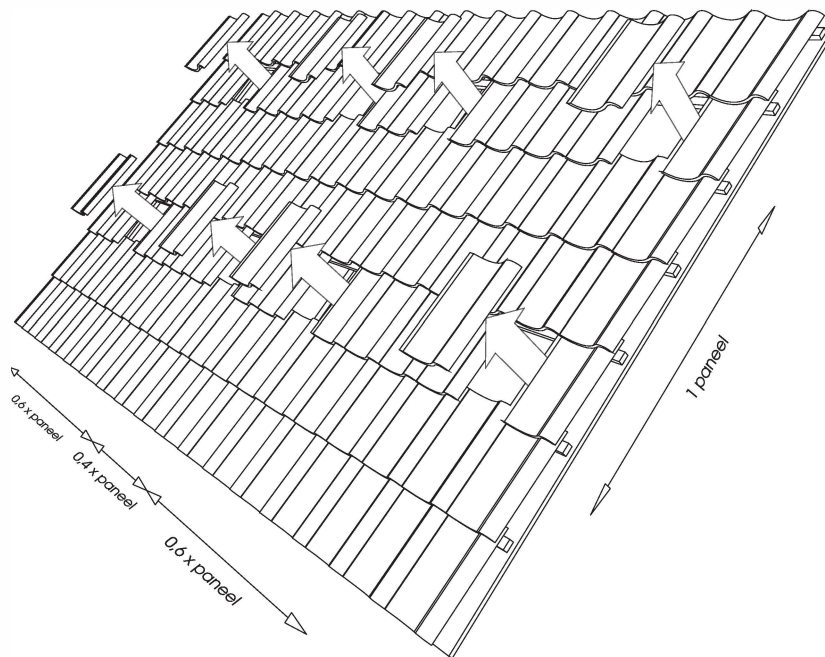

# 2

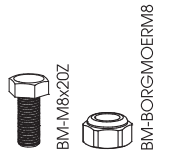
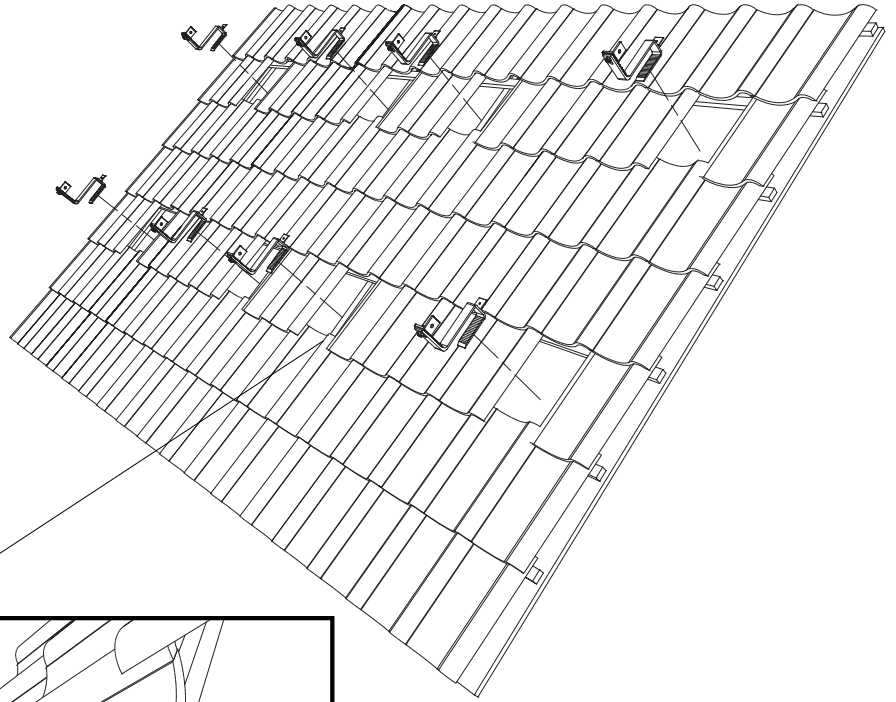
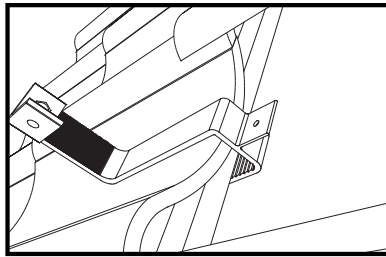
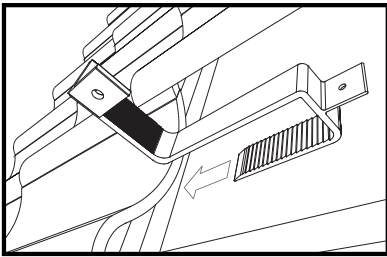
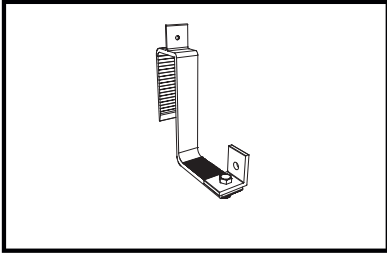
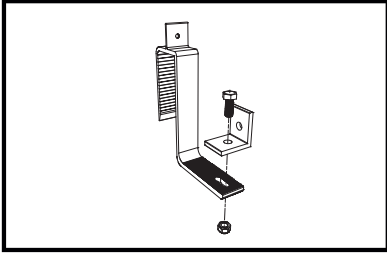

## OPTIONEEL

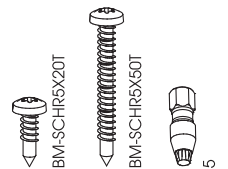
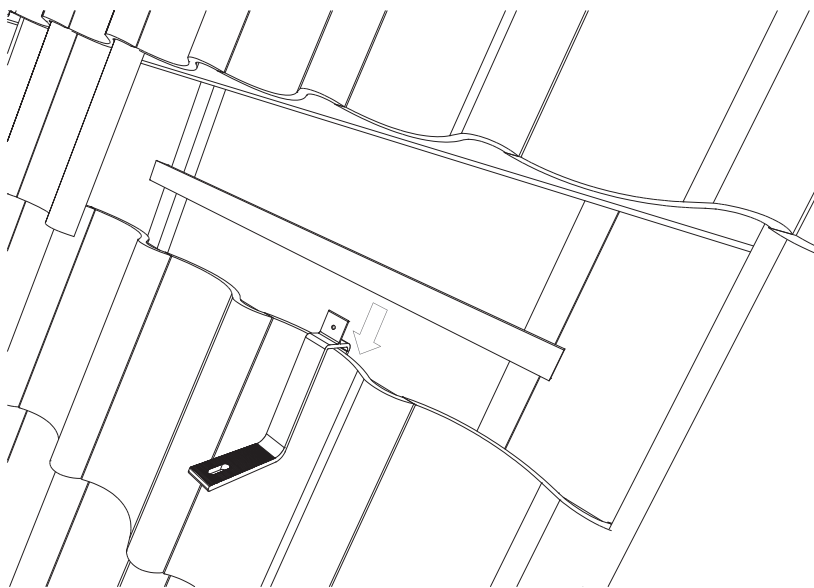

# 4

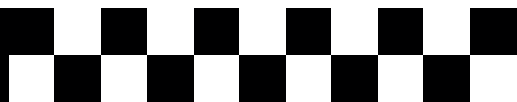

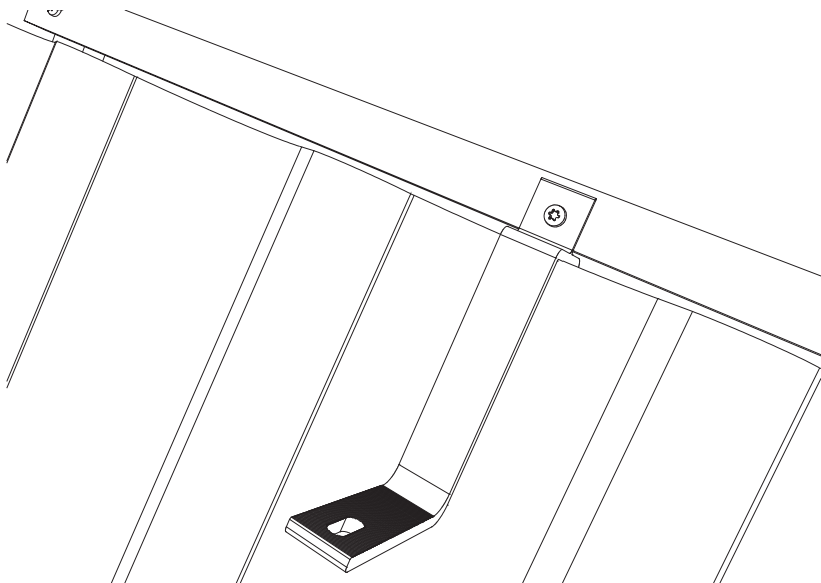
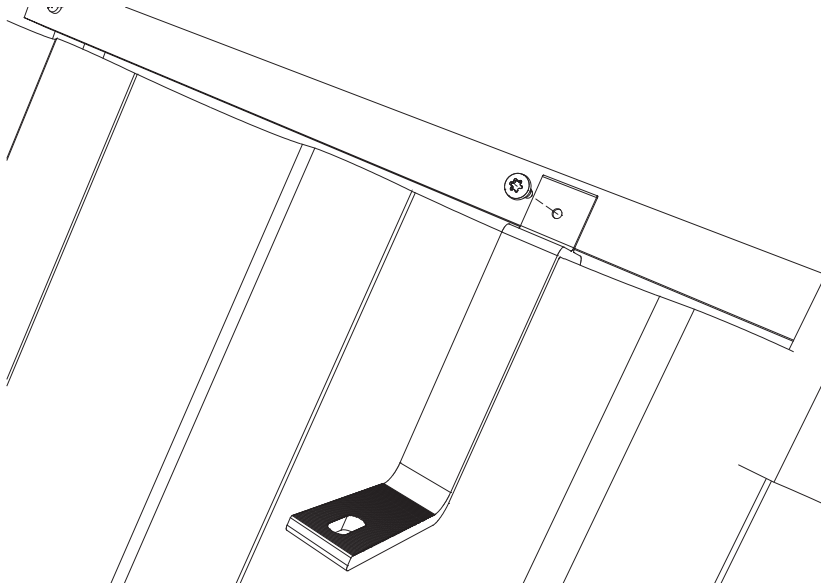
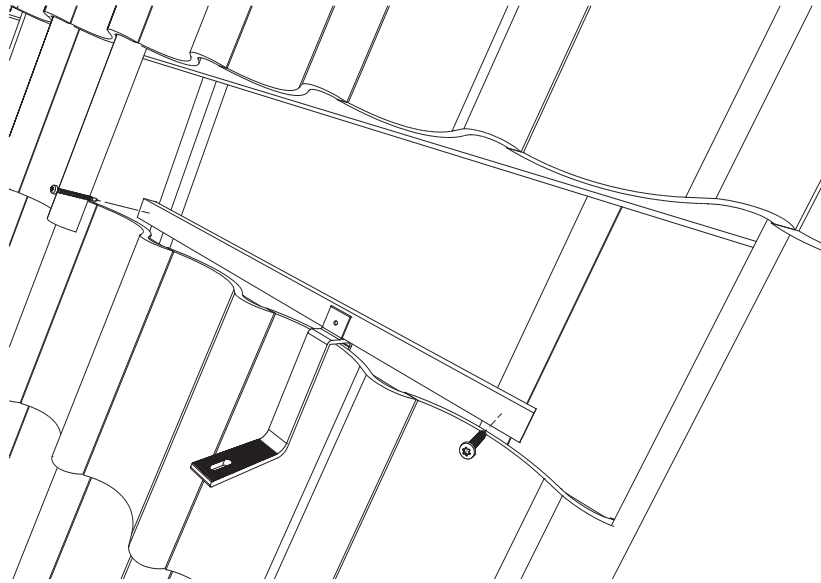

3

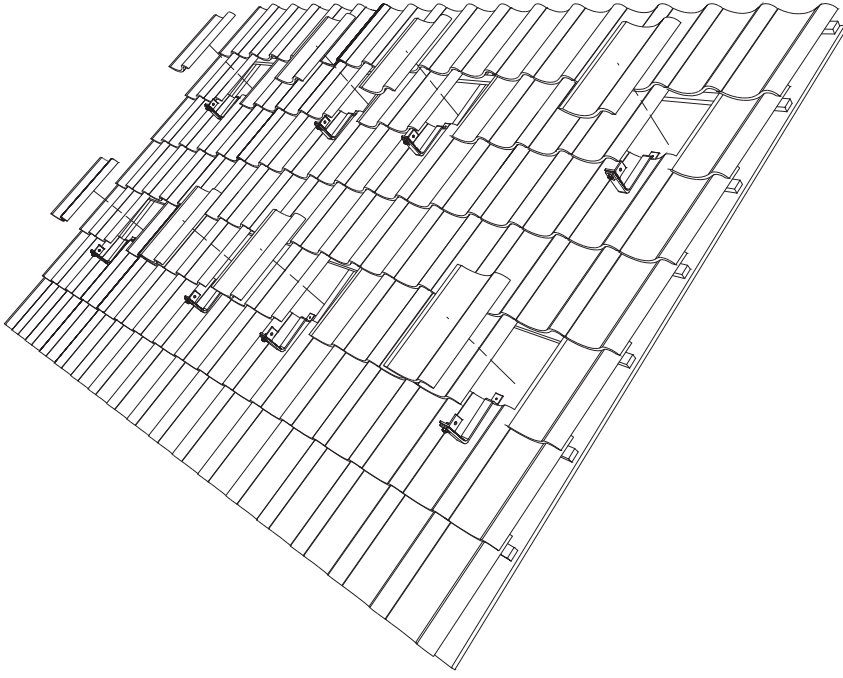

4

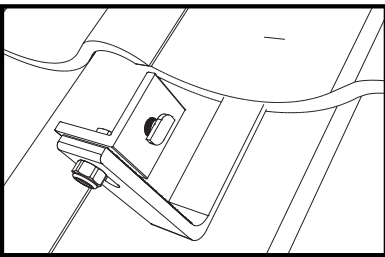
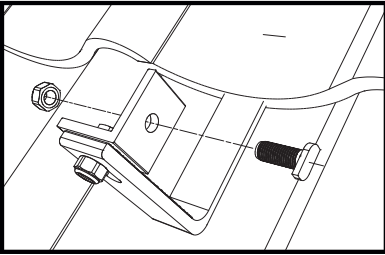
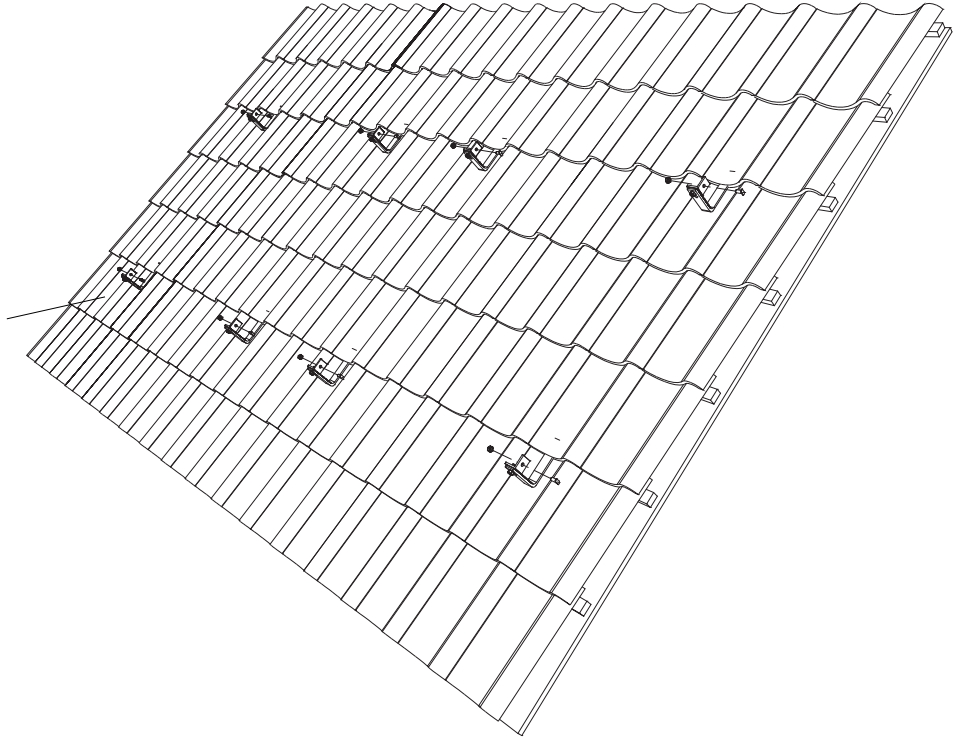

6



5

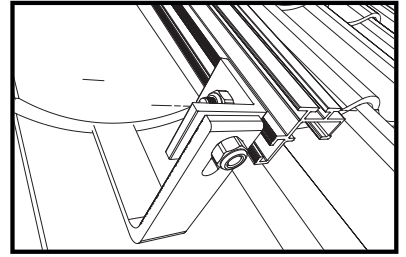
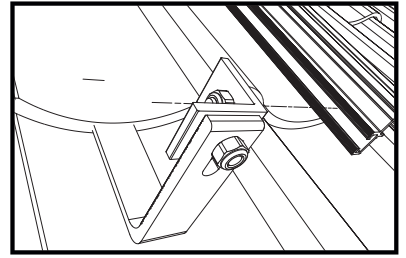
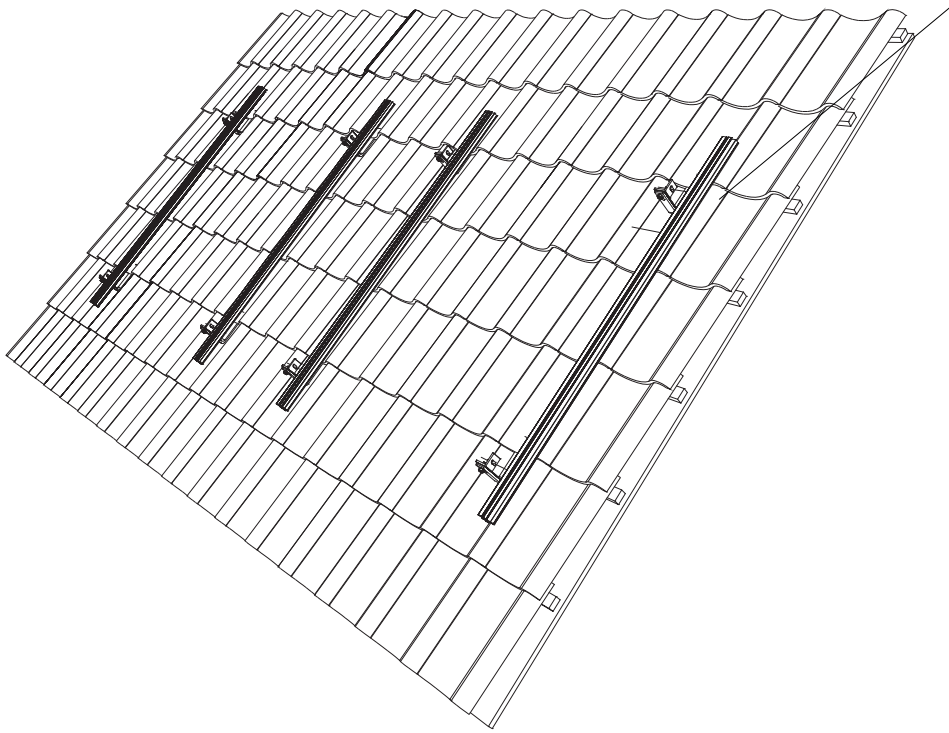

6

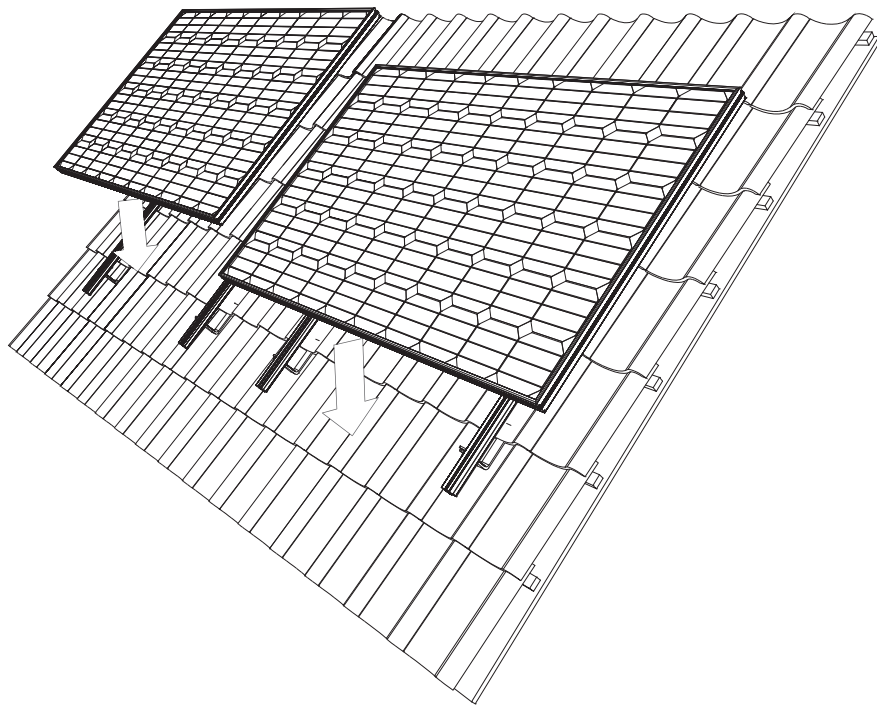

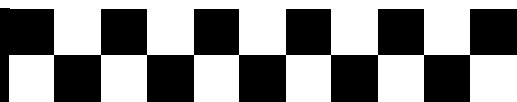
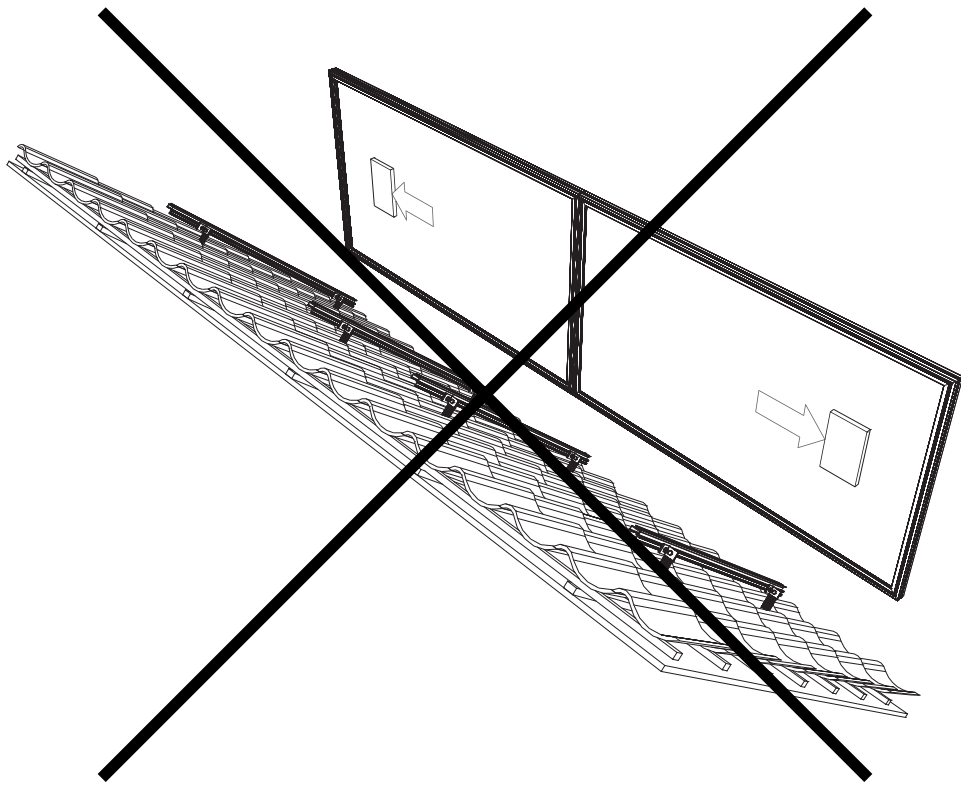
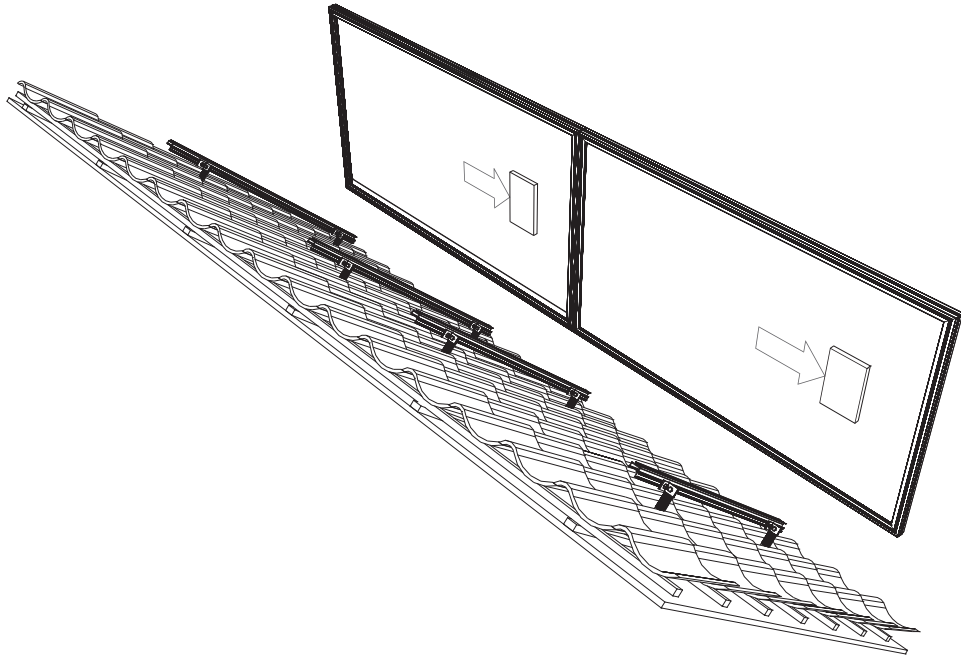



# 7

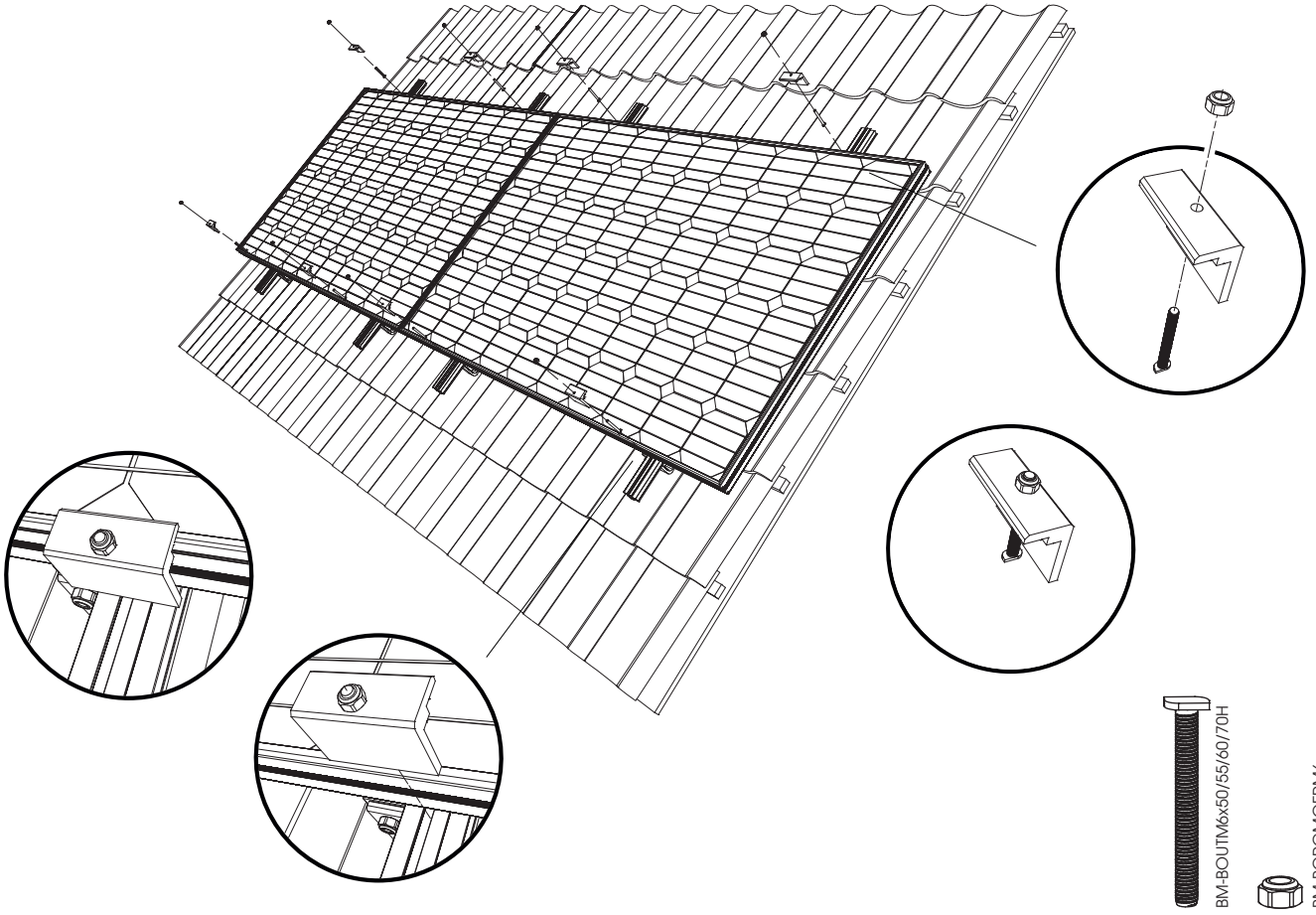

# 8

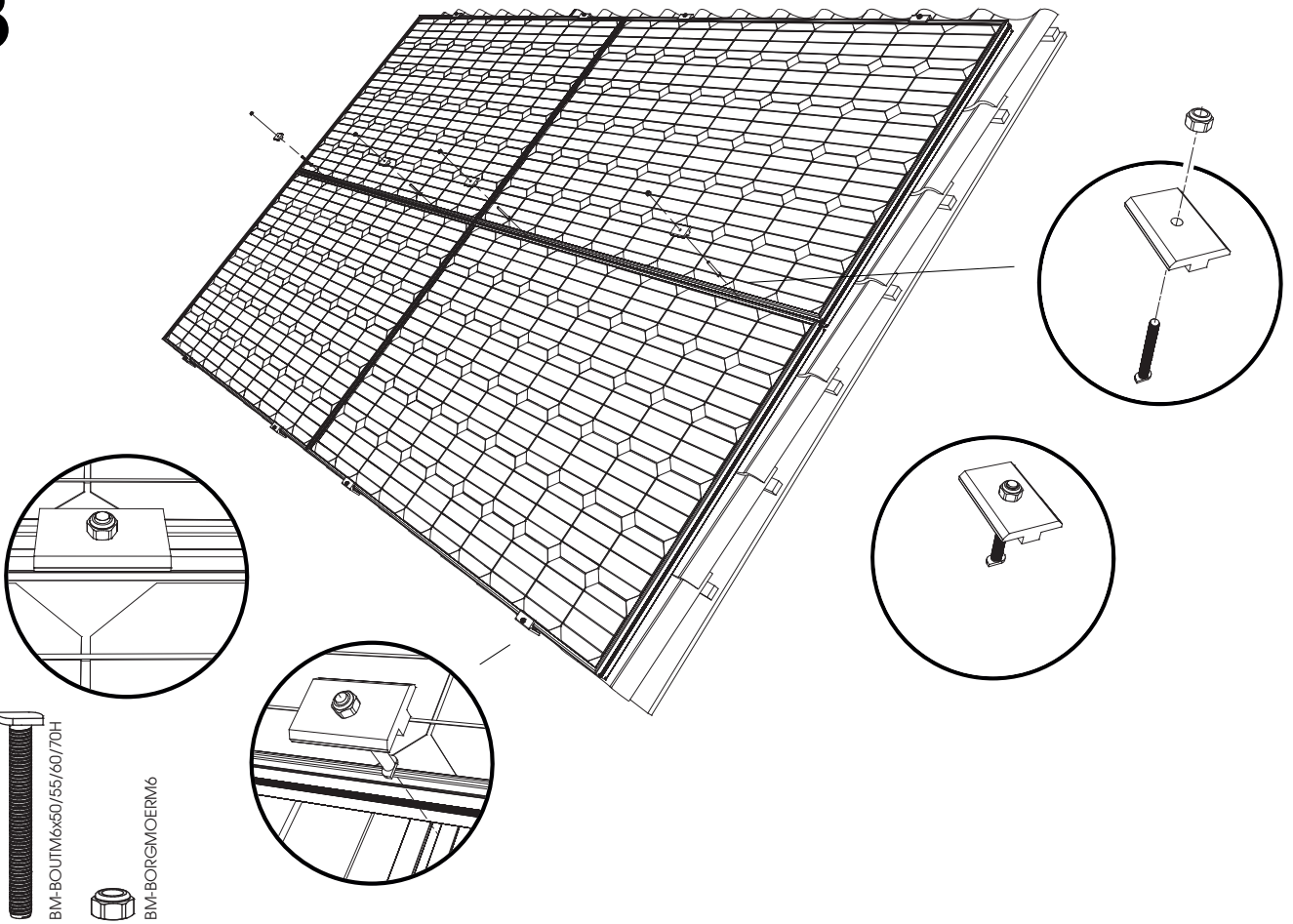

# KOPPELING

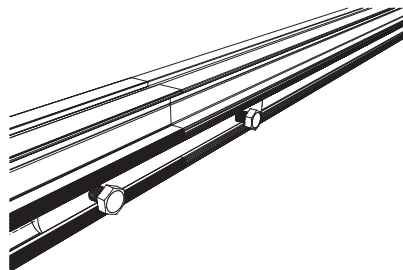
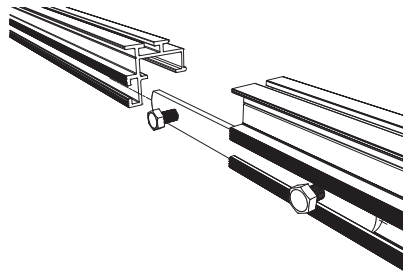
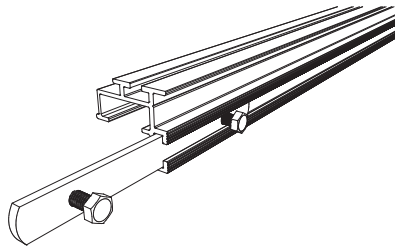
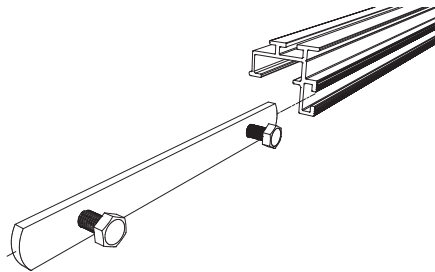
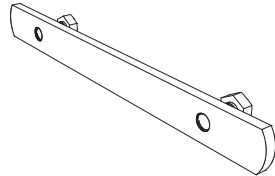
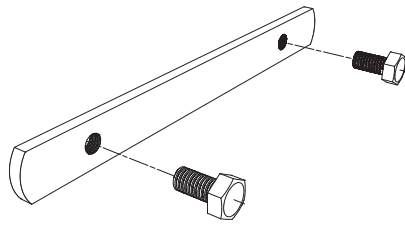

BM-V6x12Z