

Led Downlight

Introduction

Dimmable LED Downlight with side-lit technology. Dimmable brightness from 5% to 100% .120 degrees luminous flux angle. High color rendering, CRI over 80. Comfortable lighting provides the best eye protection for your work and life. Wide range of application. The Installation place is changeable, Bedroom, Bathroom, Dining Room, Etc

Features

- Ultra thin structure: thickness of the frame is 12mm.
- IP44, good dustproof and moisture-proof performance.
- 120° beam angle.
- Triac dimming.
- Simple operation and easy install.

Application Areas

Office & school lighting: office room, meeting room, class room etc. Commercial lighting: shopping mall, super market, retailer shops etc. Other situations: hospital, laboratory, dust-free workshop etc.



SKU	DOWN-4000K-BLACK-24W
Dimension(mm)	Ø240*12
Cutout (mm)	Ø225
Watt(W)	24W
Rated Input Voltage(V)	AC220V
Input Voltage(V)	AC200-240V 50/60Hz
LED Module Input	-
Light Source	SMD LED
SDCM	<6
CCT	Natural white 4000K
Luminous Flux (lm) ±10%	1920
CRI	≥80 RA
Beam Angle (°)	120°
UGR	UGR<22 (UGR<19 for option)
LED Driver	External driver
Dimming Option	Triac Dimming
Sensor	-
Emergency Kits	-
Electrical Class	Class II
Ingress Protection (IP Rating)	IP44
Impact Resistance (IK Rating)	-
Product Finishing(Base)	Black
Materials of Optics	PMMA
Materials of Housing	PS (Diffuser plate) / Aluminium (Frame)
Lifetime (hr)	30,000hrs
Glow wire test (°C)	-
Operating Temp. (°C)	-20°C~+45°C
Storage Temp. (°C)	- 20°C~+65°C
Installation	Recessed
Included Driver	
Output Voltage range	DC30-40V
Rated output current	600mA
Setup, Rise Time	<0.5S
Flickering Index	- (flicker free)
Input Current	0.122A
Rated Input Current	0.13A
Power Factor	≥0.9
THD	≤15%/220Vac
Efficiency	≥85%/220Vac
No load wattage	≤1W
Short circuit protection	PASS
Over voltage protection	PASS
Over temperature protection	PASS
Withstand voltage	I/P-O/P: 3.0KVac,<5mA 60S
Isolation Resistance	I/P-O/P,I/P-FG,O/P-FG:500VDC,>100MΩ

Dimension (mm)

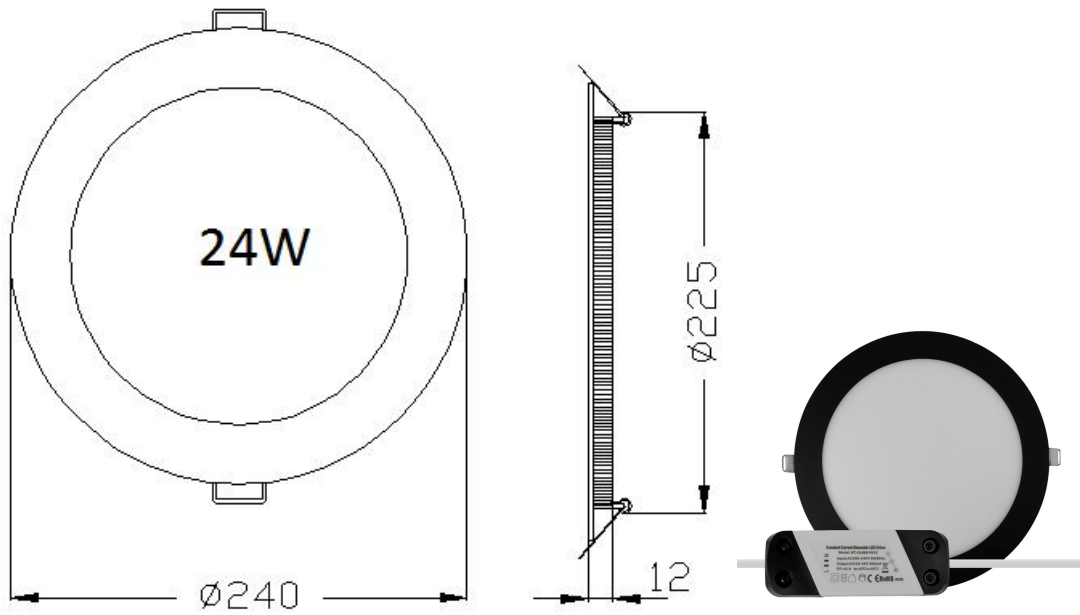

Packing information

Model	Size (mm)	Product Weight (Kg)		Outcarton size (W*L*H)	QTY/CTN	
		N.W/CTN	G.W/CTN		Innercarton	outcarton
DOWN-4000K-BLACK-24W	Ø240*12	11.7	14.6	40*33*59cm	5pcs	20pcs

Installation Procedure

WARNING!!!

- Switch off the power before installation / maintenance.
- Switch on only after complete installation and examination of the circuit.
- Professional electrician for installation and maintenance only.

1. First of all, switch off the power.
2. Open a hole on the ceiling as required cutout size.
3. Connect power supply and AC circuit for the downlight.
4. Stuff the lamp into the hole, finish installation.

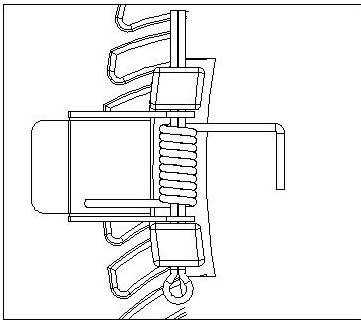

1, Mounting clips assembled as shown

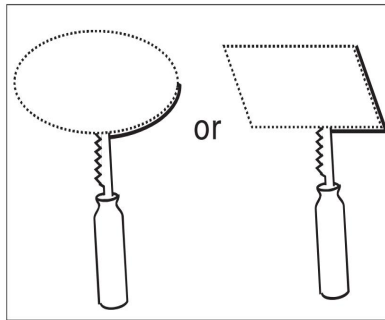

2, Open a hole according to the cutout size of the LED Downlight.

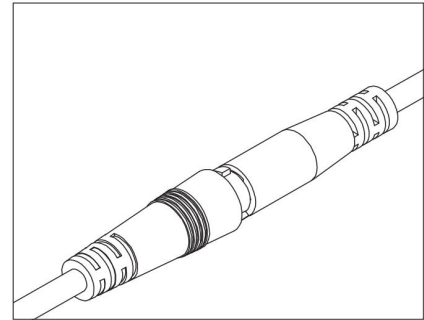

3, Connect the LED Downlight with the driver.

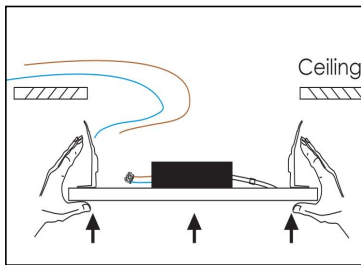

4, Connect the driver and AC circuit. Hold back the spring clip then push the LED Downlight into the hole .

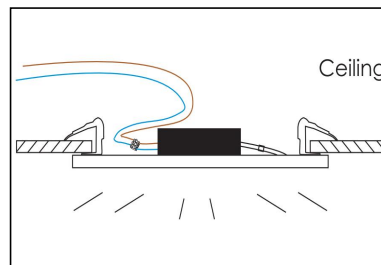

5, Complete installation.

