



**ENGLISH**

**OWNER'S AND  
INSTALLATION MANUAL**

**AIR PURIFIER**

CAFN026LC2 | CAFN036LC2 | CAFN051LC2

# Content

---

1 Security note .....	29
2 Product Introduction .....	31
Control panel .....	32
Other items in the package.....	32
3 Before use .....	33
Record the beginning use date in the label .....	33
Learning air quality indicator .....	33
Method of dismounting and installation .....	34
Placement sites of Air Purifier .....	34
Install filters .....	35
Filters and functions .....	37
4 How to use .....	39
The control panel .....	39
Plug in the power.....	39
Starting air purifier .....	39
Auto mode .....	40
Sleep mode .....	40
Wind speed adjustment .....	40
Timing function .....	40
WIFI function .....	40
UV function(Negative ion function) .....	41
Reset .....	41
Air quality indicator .....	41
5 Cleaning and Maintenance .....	42
Clean air purifiers.....	42
Clean air quality sensor.....	42
Clean the pre-filter.....	43
Operation steps.....	43
Replace filters.....	45
Operation.....	45
Unused for a long time .....	47
Replace filter reference time.....	47
6 Fault handling .....	48
7 Additional information .....	49
Warranty and service .....	49
To order parts or accessories .....	49
Accessories.....	49
Recycling .....	49
8 WIFI use guide .....	50

---

# Security note

In order to avoid possible damage to you or others or financial damages, please be sure to pay attention to the following safety precautions.

If the machine's power supply cord is damaged, you must entrust the manufacturers of the machine, maintenance service center or qualified technicians will change for you, in case of any danger.



## Warning



Don't touch the power plug with wet hands.

**No wet hands!**

Otherwise it may cause electric shock.



Before cleaning appliances, please make sure have power off.

**Pull the plug!**

Otherwise air purifier may run suddenly, cause accident getting an electric shock.



It is prohibited to use beyond power or connected devices specified value. Only 220V ac power allowed.

**Banned!**

Using universal socket or exceed the specified value of the equipment may cause overheating and fire accident.



Before start the air purifier, please insert the plug completely into the socket.

Failure to fully inserted into the socket may cause electric shock and overheating or fire accident.

- Do not use damaged plug or loose power socket.



No damage on the power line and socket.

**Banned!**

In the use of the machine, don't bind, wires. Use the broken wire may cause electric shock, short circuit or fire accident.

- Ban cut, modification, excessive distortion, torsion, pull wire, or put weight on wires or plugs.



Please clean power plug regularly.

Accumulation of dust on the power plug and the moisture can damage the insulation of the plug part, resulting in fire accident.

- Pull out the power plug, then wipe with dry cloth (ban using wet cloth!).
- Remember to pull the power plug if not use for a long time.



Prohibit unauthorized apart or modified the air purifier.

**Banned take apart**

Otherwise it may cause electric shock, failure or fire accident.



Ban rod or other metals placed in the outlet or inlets.

**Banned!**

Otherwise it may affect the internal parts and cause electric shock or damage.

# Security note

## Attention

**Any situation as below, please turn off the power of the machine.**

- A switch does not work.
- A circuit breaker or fuse burned.
- The power cord or plug is hot abnormally.
- Finding the burning odor or abnormal sound or vibration.
- Any other anomalies or failure.



## Attention



Prohibited use solvent such as benzene or thinner to clean air purifier, avoid touching with insecticide spraying.

Banned!

Otherwise air purifier can rupture and cause damage, even short circuit, so that cause electric shock or fire accident.



Pull out the power plug, should hold the plug, instead of pulling wires.

Otherwise it may cause short circuit, wire and cause fire or electric shock accident or injury.



Ban in place for being fat particles using this air purifier.

Banned!

Such as inside the kitchen, can reduce the service life of air purifier filter.

- The air purifier should not be used for ventilation or extraction equipment.



Banned in high temperature, damp or wet body sites using this air purifier, such as the bathroom.

No wet!

Air purifier may leakage caused electric shock or fire accident.



Do not put the volatile substances or combustible materials, such as tobacco or matches to float into the machine.

Away from the fire!

Away from the fire! Otherwise it may cause fire accident.



Banned use the air purifier in indoor with fumigation type pesticides.

Banned!

Chemical residue could be accumulated inside the machine, and then release from the outlet to harm health.

- After using pesticides, please let thoroughly ventilated room, before using the air purifier.



This appliance can be used by children aged from 8 years and above and persons with reduced physical, sensory or mental capabilities or lack of experience and knowledge if they have been given supervision or instruction concerning use of the appliance in a safe way and understand the hazards involved.

Children shall not play with the appliance. Cleaning and user maintenance shall not be made by children without supervision.



Wet body is prohibited.

No wet!

Otherwise it may cause electric shock and fire accident due to short circuit.

# Product Introduction

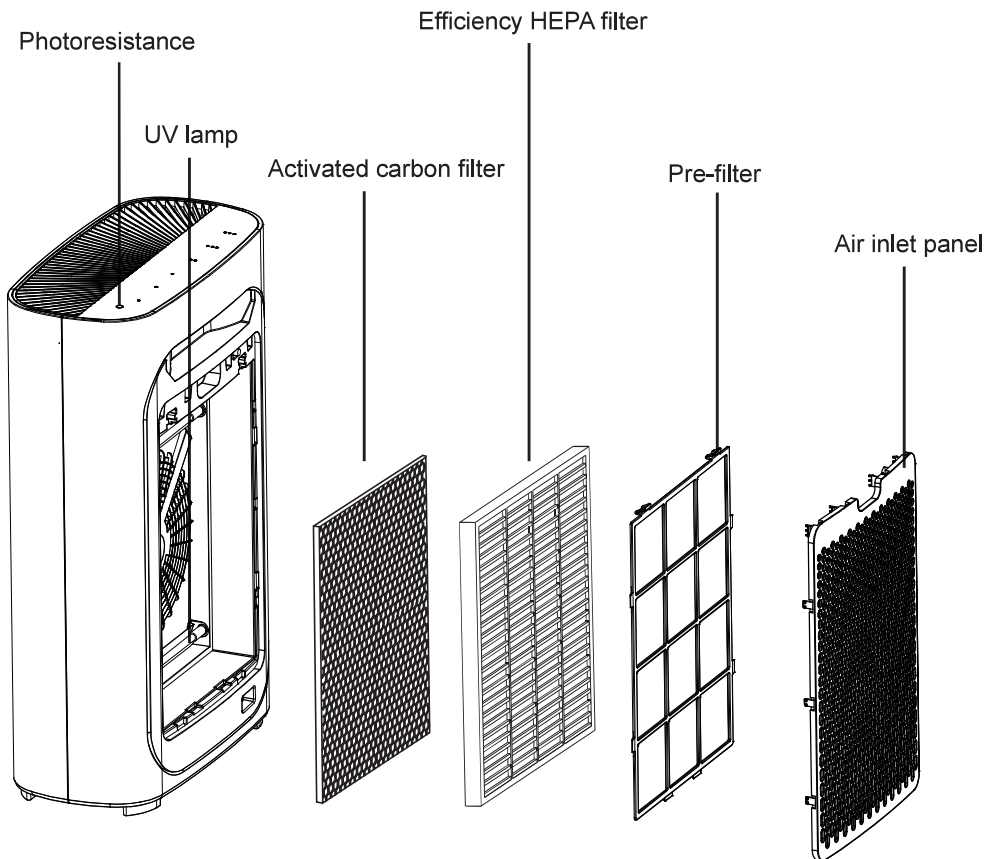
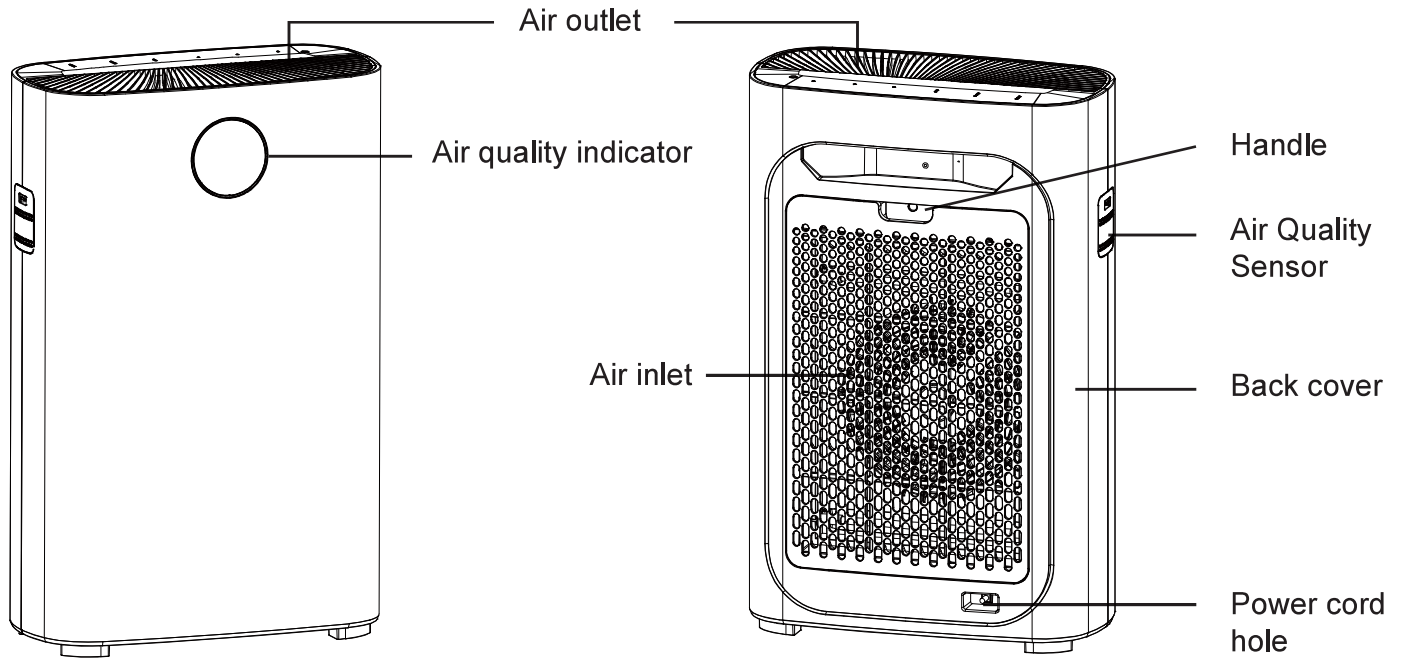

# Product Introduction

## Control panel

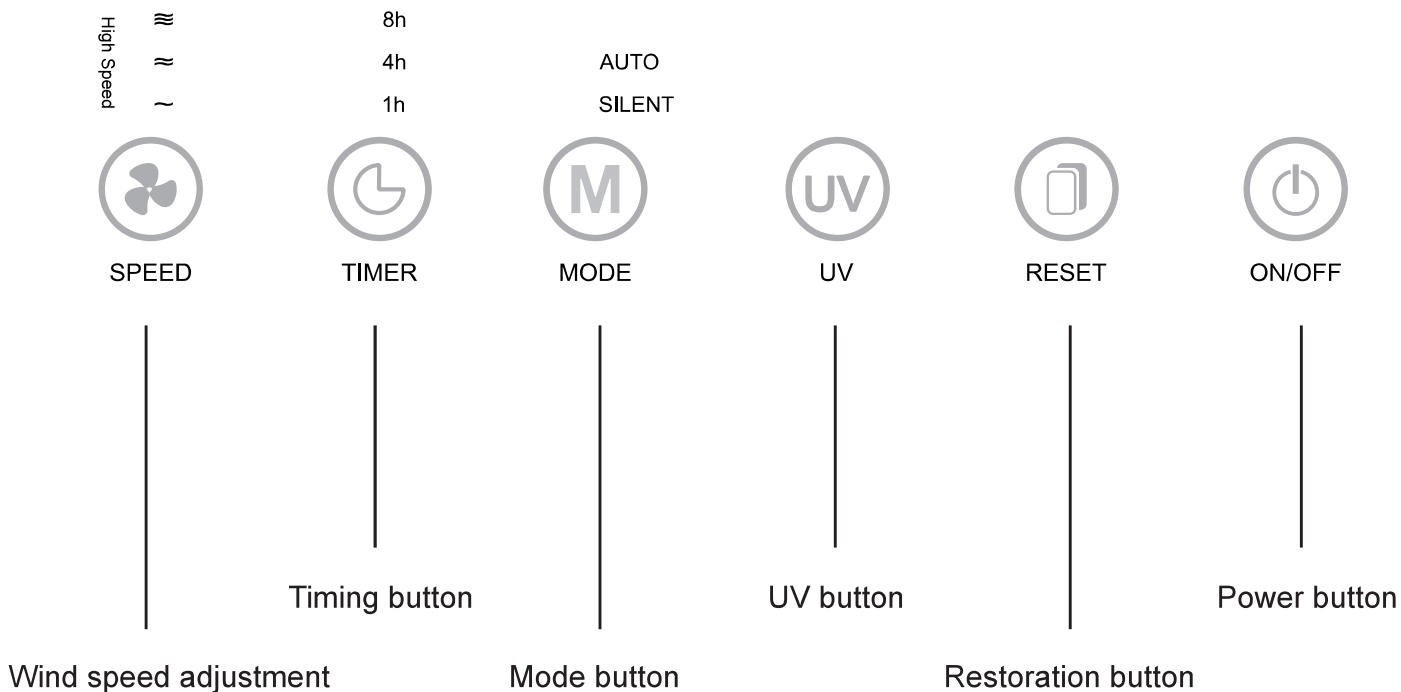

## Other items in packing

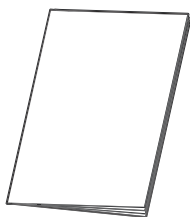

operation manual

## Air quality indicator

	Blue	( PM2.5=0~50 )	Perfect
	Green	( PM2.5=50 ~ 100 )	Good
	Purple	( PM2.5=100 ~ 150 )	Normal
	Red	( PM2.5=150 ~ )	Bad

**Notice: Please press the restoration button, if you want to turn off the air quality indicator light.**  
(PM2.5 digital display just for reference)

# Before use

## Record the beginning use date in the label

In order to replace the filter on time, before using air purifier, please keep the date recorded in the back of the nameplate, thus to achieve the best performance.

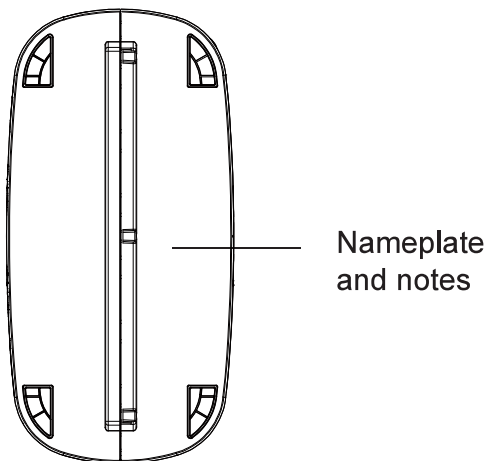

### Tips

After removing the plastic package of each filter, the efficient HEPA filter and activated carbon filter must be replaced once a year.

Photocatalyst filter should be replaced every three years, after a period of time, should exposure under sunlight more than 2 hours.

## To know the air quality indicator

Air quality indicator can reflect the air quality conditions, please refer to the specific page 6 and page 14.

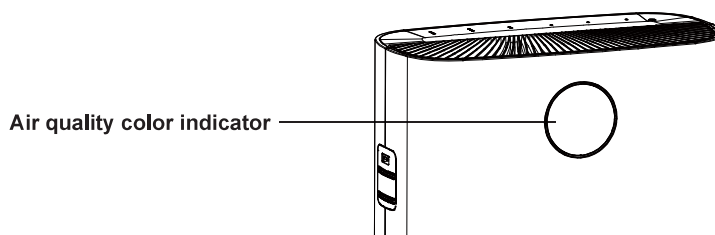

# Before use

## Method of dismounting and installing the air inlet panel

### 1 Method of removing the air inlet Panel.

Hold on to the groove at both sides of the air inlet panel, then gently pull it up.

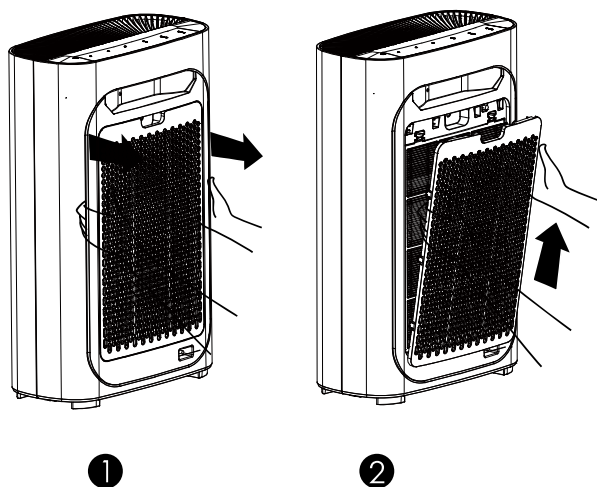

### 2 Method of installing the air inlet panel.

Reinstall the air inlet panel, alignment and insert it into the fixed groove, and then gently push it up.

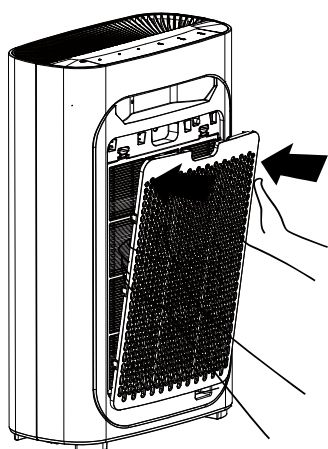

## Placement sites of air purifier

In order to make your room air to achieve good effect on both sides of the cycle, make sure the gap between the air inlet and the wall at least 50 cm, the air outlet at least 10 cm.

Please keep 1 meter away from television, radio, etc.

Please do not put the power plug together with the television, radio and other electrical power plug inserted into the same socket, (otherwise it may cause screen jitter and noise generated.)

- The long-term placement in the same sites may dirty the host walls.
- To ensure the machines have adequate ventilation and maximum efficiency, don't interfere with the air outlet and air inlet.

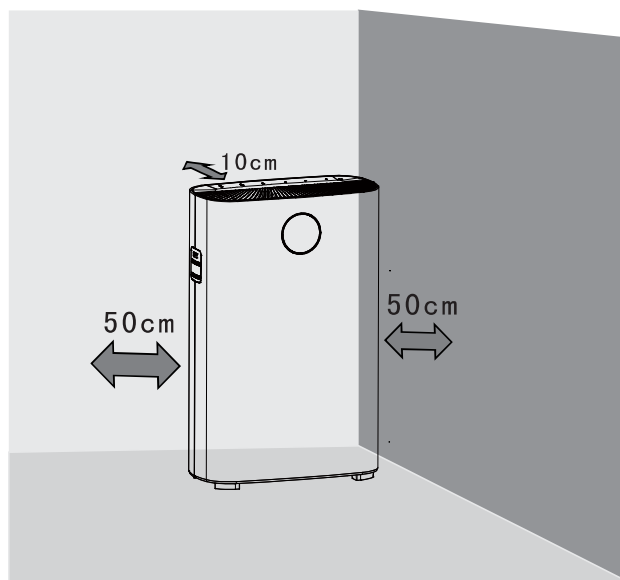



# Before use

## Install Filter

### Information

Please remove all the package of all the filters in the machine before using the air purifier, according to the below instruction.

#### ⚡ Attention

- Please make sure the power plugs have been put off before installation, maintenance and transportation.
- Please do not operate the air purifier without the filters.
- Please remove the package of each filter before using.

#### 💬 Tips

You can put the purifier on the wall to enhance the stability when removing or installing the filters.

### Steps

Initial use this air purifier, please install the filters correctly as below instructions.

1. Please remove the all packages and put the purifier on the dry, stable, horizontal ground.

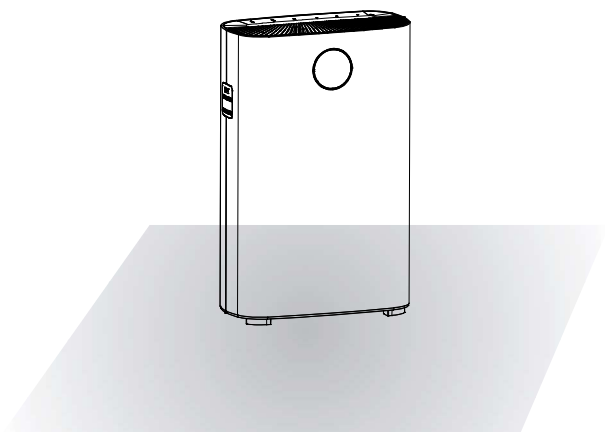

2. Hold on the grooves at both sides of the air inlet panel, then gently pull it up.

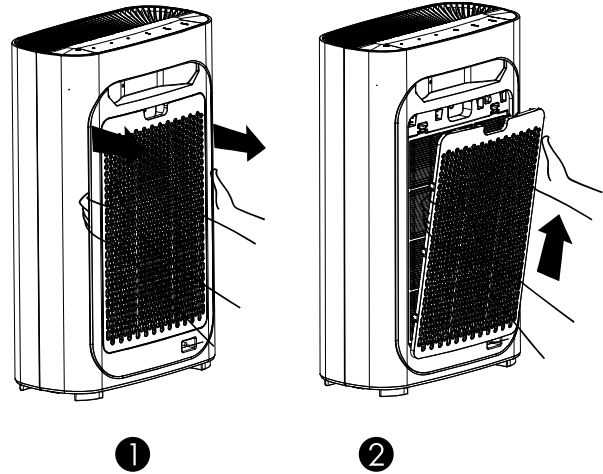

3. Take out all filters from this purifier.

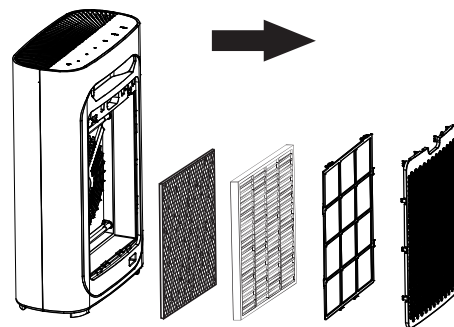

4. Remove all packages.

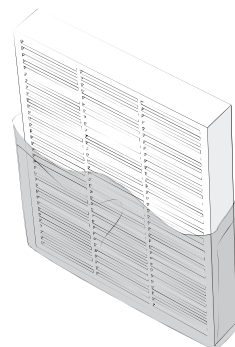

# Before use

5. Install all the filters in order.

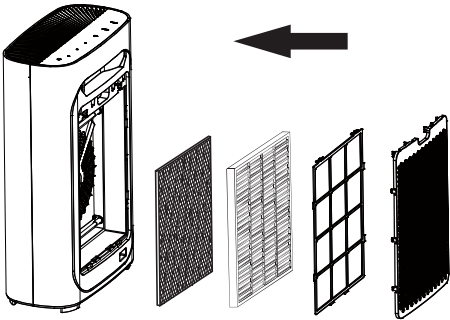

6. Install the pre-filter as the instruction.

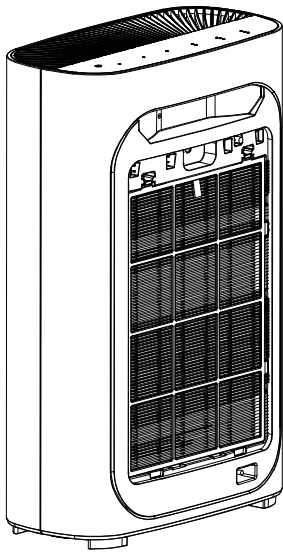

7. Install the air inlet panel again. Align and insert it to the fixed grooves, then gently push it.

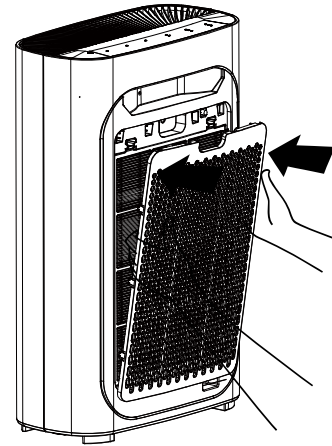

 Tips

Please be carefully when install the air inlet panel.

# Before use

## Filters and function

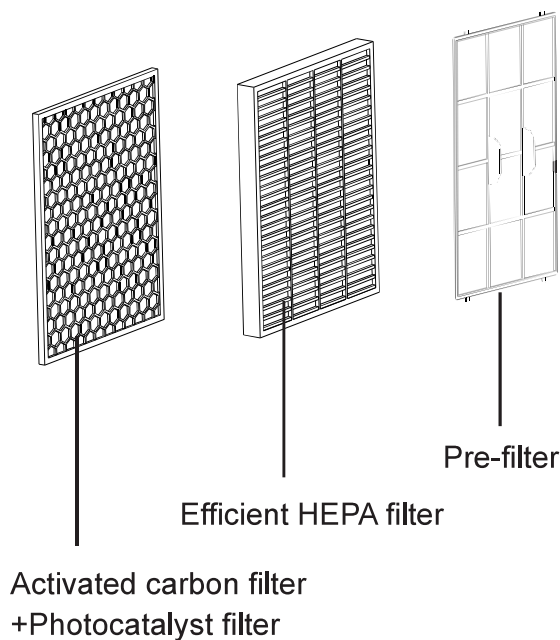

**4 points purification system, could effectively purify the air, make life more healthy.**

**One: Pre-filter**

**Two: Efficient HEPA filter**

**Three: Activated carbon filter**

**Four: UV lamp**

### **One: Pre-filter**

Use micron mesh filter, effectively block 2.5mm fibrous particulate matter, Blocking rate > 99.9%. It can be cleaned easily by tens of thousands times.

Preventing larger particles such as pet fur, dander and coarse dust, etc. Can increase the life of the following filters.

### **Two: Efficient HEPA filter**

The rate of removing the minor particles small to 0.3 micron from the airflow can up to 99.9%. Spread of allergens and bacteria in air flow, such as pollen, smog and viruses.

### **Three: Activated carbon filter**

Removing volatile organic compounds, such as secondhand smoke and kinds of polluting gases.

### **Four: UV lamp**

Effectively kill a variety of common bacteria and viruses, inhibit the production of bacteria and viruses.



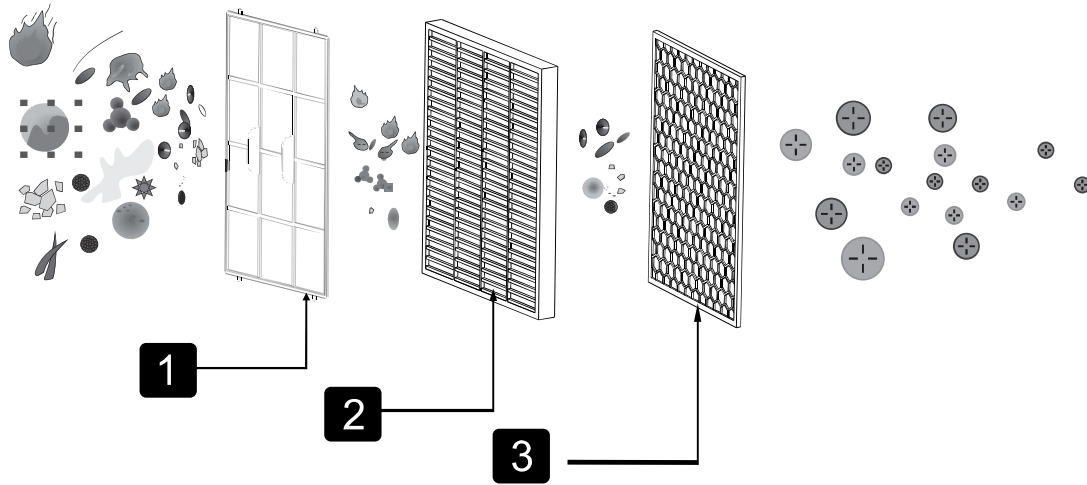







# Before use



## Tips

Cold cathode UV lamp trigger voltage is only 500v, will not produce ozone, can use it safely.

## The allergens

			
Coarse dust	Hair	Harmful Particles	Dander
			
Dust	Pollen	Pet fur	Smoke
			
Dust mites	Odor	Chemical substances	

# How to use

## Control panel

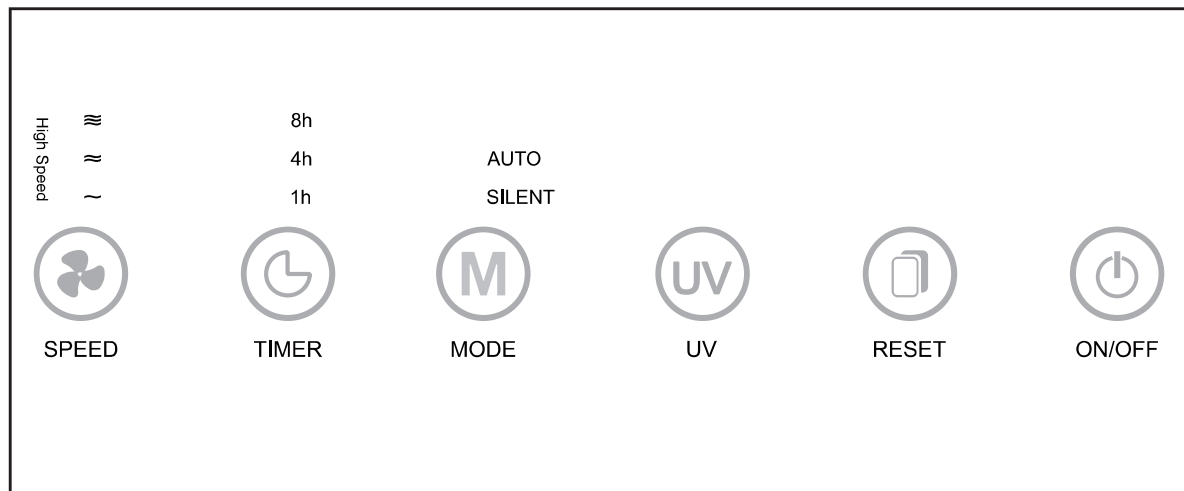

## Plug in the power

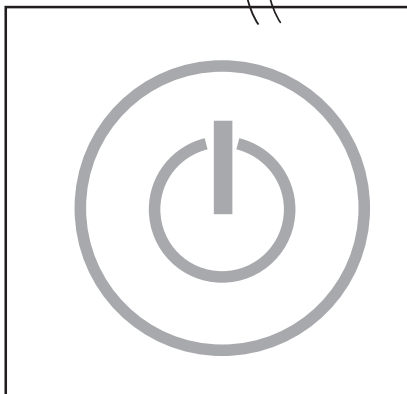
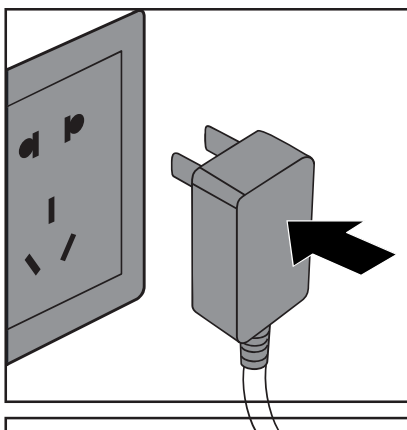

Plug in the power. The music starts and all the lights flash 3 times continuously, then all the lights off, leaving only the power indicator light in red, enter the standby mode.

## Starting air purifier

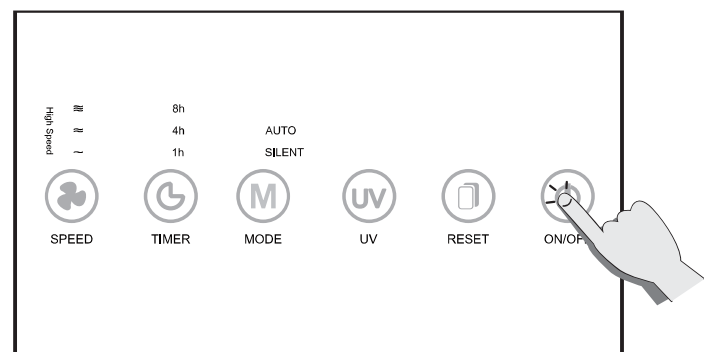





Press the power button to enter into auto mode with the lights on.

When the machine start, the air quality indicator light will be slow flashing on, it begins to detect the air quality after preheating for 5s.

When auto mode start, it will detect the air quality automatically.

# How to use

## Air quality indicator

	Blue	( PM2.5=0~50 )	Perfect
	Green	( PM2.5=50 ~ 100 )	Good
	Purple	( PM2.5=100 ~ 150 )	Normal
	Red	( PM2.5=150 ~ )	Bad

**Notice: please press the restoration button, if you need to turn off the air quality sensor light.**

## Auto mode

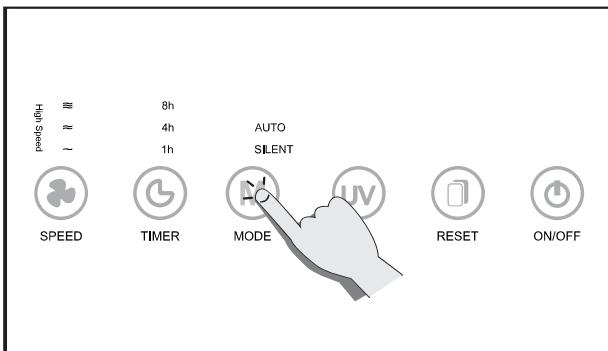

Turning the power on it will detect the air quality automatically. Choosing the auto mode, will give you the most appropriate fan speed.

## Sleep mode

Sleep mode, have built-in radial sensor, which will sense the strength of the light. If the light intensity is under the condition of insufficient, all lights of the machine will be dimmed, and at the same time, the machine automatically change to silent mode of operation, to do not disturb your rest at night.

## Wind speed adjustment

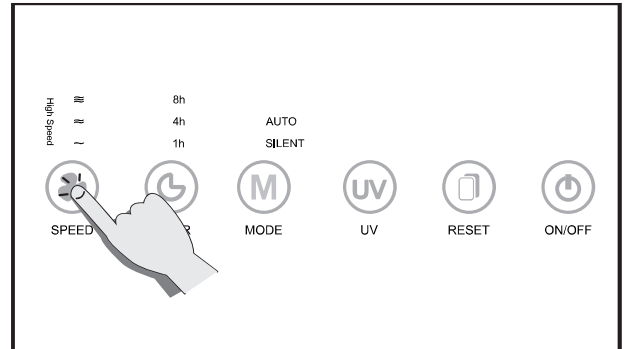

Wind speed can be selected in one, two, three grade.

## Timing function

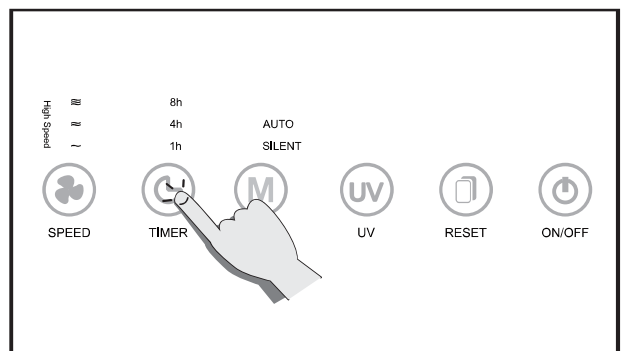

Tap this key to switch the timing between 1h, 4h and 8h.

## Wifi function

Press and hold for 5 seconds to turn on the Wifi function on within in 5 seconds after turn on the machine.

# How to use

## UV function(Negative ion function)

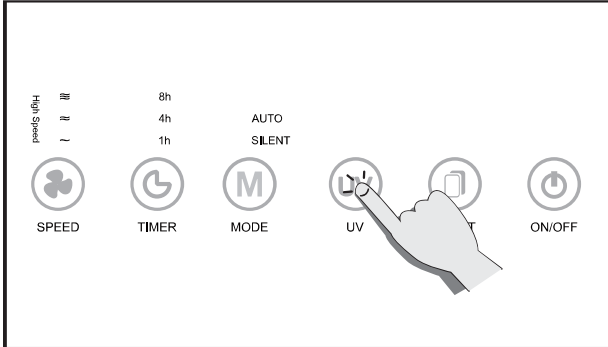

Press the UV button to open the UV lamp.  
Press and hold for 5 seconds to turn the ionizer function on or off.(the ionizer function automatically open when the machine power is on)

## Reset

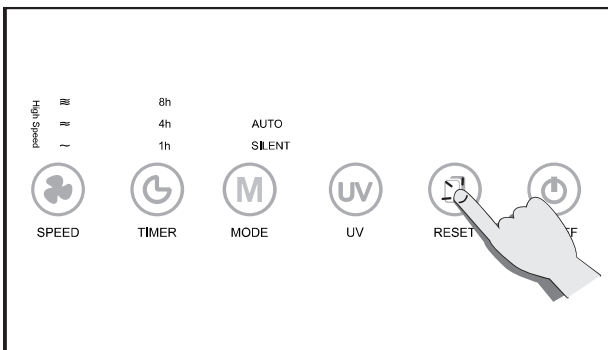

Reset the machine by pressing the button for at least five seconds, (This function is only available after the replacemnt remind of filter.).

## Air quality indicator

Flip this button to open/close air quality color indicator.

# Cleaning and maintenance

Be sure to pull out plug before cleaning.

Do not put the product into water or any other liquid. Do not use corrosive or flammable gas (e.g. bleach or alcohol) to clean any part of the product.

Only pre- filter can be cleaned with water, other filters can't.



## Clean air purifier

Clean the medial and lateral regularly to prevent dust accumulation.

- 1.use soft dry cloth to wipe the dust.
- 2.use soft dry cloth to clean inlet and outlet.

## Clean air quality sensor

Clean the air quality sensor every two months to make sure purifier run at the best performance. If the purifier used in dusty environment, please clean it more often.

### Attention

When the indoor humidity is very high, the air quality indicator may be forming condensate. So even if the air quality is good, air quality indicator may also indicate poor air quality, in this case, you have to clean the air quality indicator or use any manual speed setting.

1. Use a soft brush to clean the inlet/outlet of air quality sensor.

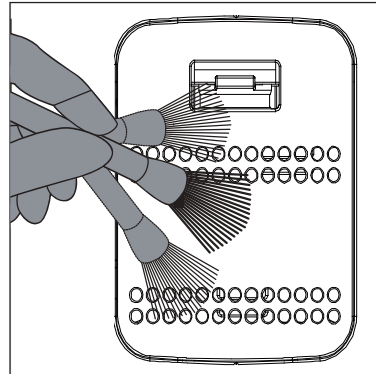

2. Remove the protective cover of air quality sensor.

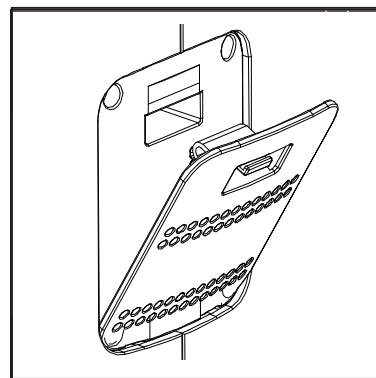

3. Clean the air quality sensor, inlet and outlet with wet cotton swabs slightly.

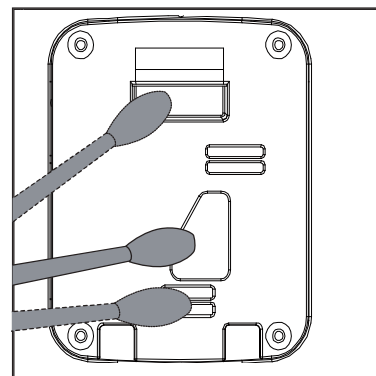

4. Dry it with dry cotton swabs.

5. Remount the protective cover of air quality sensor.



# Cleaning and maintenance

## Clean the pre-filter

### Information

In order to achieve the best performance, clean and maintain the Pre-filter every two months (about 480 hours) from the beginning to use.

Based on the average 8 hours a day, 7 days a week frequency, keep the machine working under the household environment.

External maintenance : use wet cloth(or the mild detergent)to wipe the surface to prevent the accumulation of dust.

Turn off the air purifier and pull out the plug before cleaning and maintenance.

Only the pre-filter can be cleaned, other filters can't.

### ⚡ Attention

Please use the low power vacuum cleaner, preventing the filter from damage.

### 💬 Tips

Before putting each filter into the machine pls remove the plastic packaging, and ensure that the labels on the filters are outwards.

## Operation steps

1. Turn off the power to stop the air purifier.

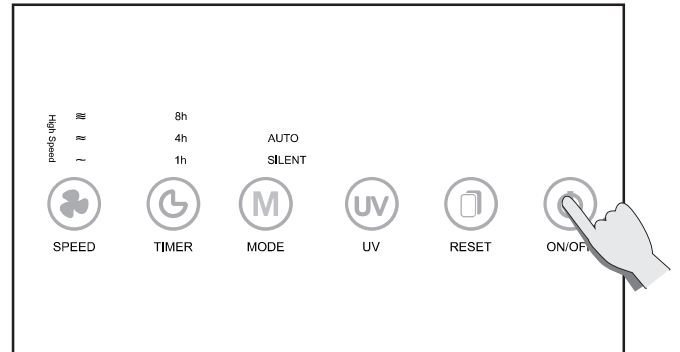

2. Pull out the power plug.

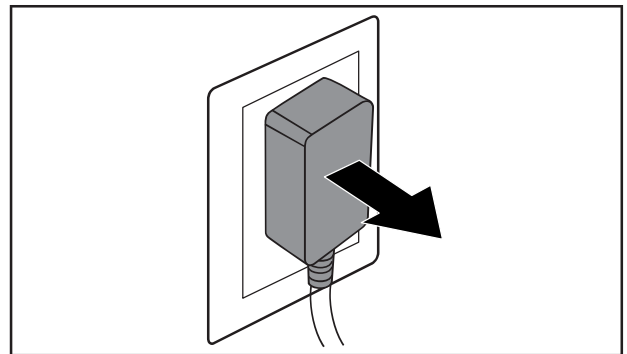

3. Hold on groove at both side of the front panel and pull it outward. Then remove it upwards.

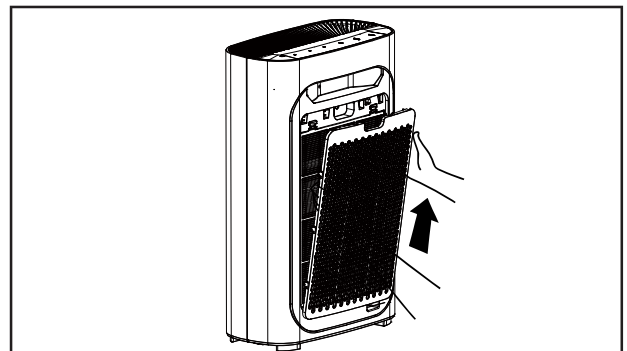

# Cleaning and maintenance

4. Remove the protruding part of the gauze filter before cleaning it.

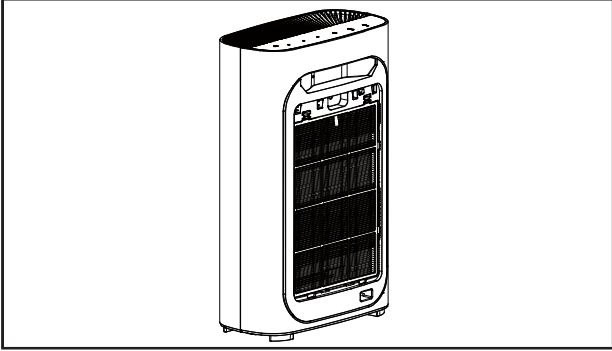

7. Re-install the front plate, align and insert into the fixed groove, then gently push it up.

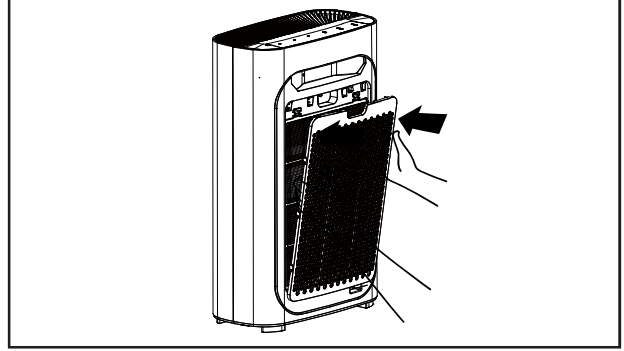

5. Use a soft brush or a vacuum cleaner to remove particles, please use water or soap water to clean the filter, then place it into the machine when it is completely dry

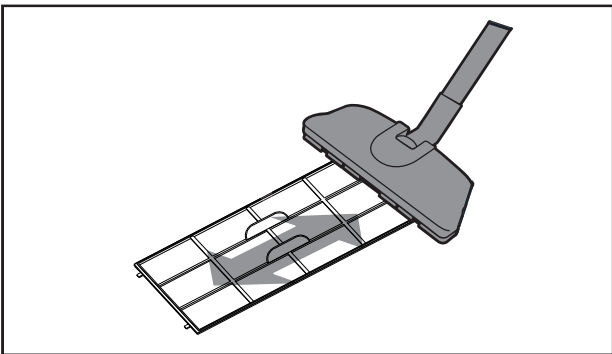

8. Plug in.

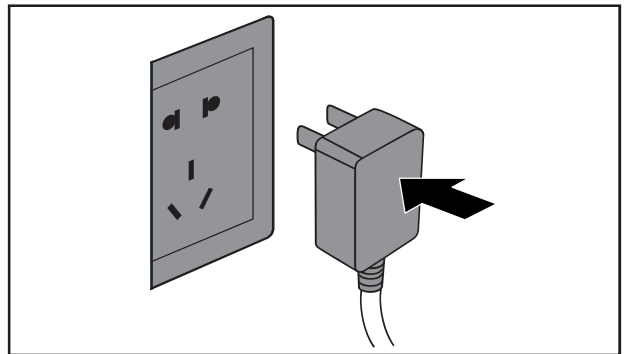

6. Put back the pre-filter into the air purifier.

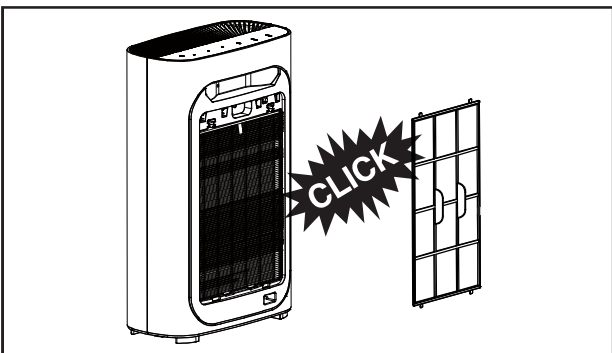

9. Turn on the power and start the air purifier.

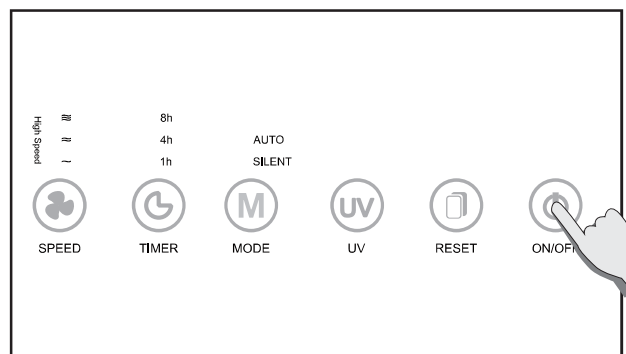

# Cleaning and maintenance

## Replace filters

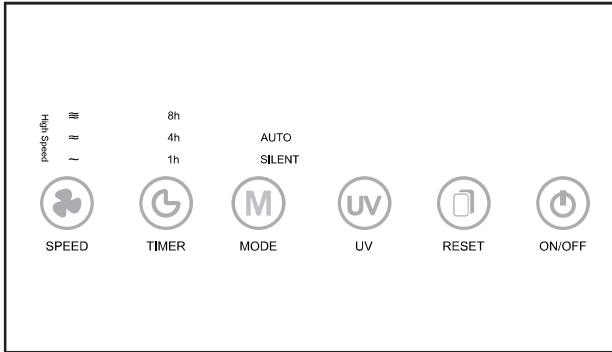

A reminding of filter replacement comes when machine in normal working for more than 1600 hours, and the power lights flash slowly (the red lights flashing when standby, the blue lights flashing when it is working).

After the indicator light of replacement of filter shows, the machine can still work.

### ⚡ Attention

Please turn off the power and pull out the power plug before replacing the filter.

### 💬 Tips

Remove all the plastic packaging of each filter before put into machine, To ensure the filter label is outward.

## Operation

1. Reminding to replace the filter.

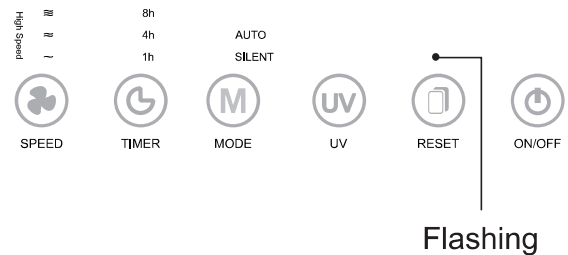

2. Turn off the power, then pull out the power plug.

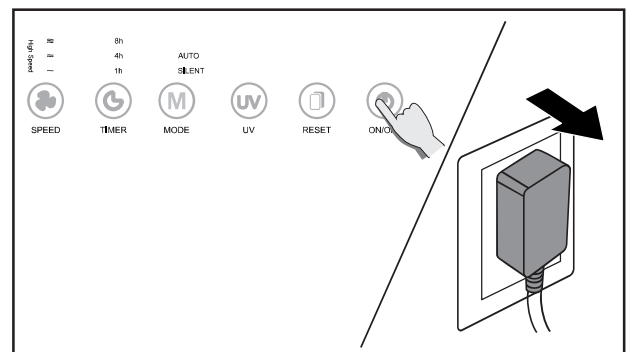

3. Hold on the grooves of both side of the front panel, then gently pull it up.

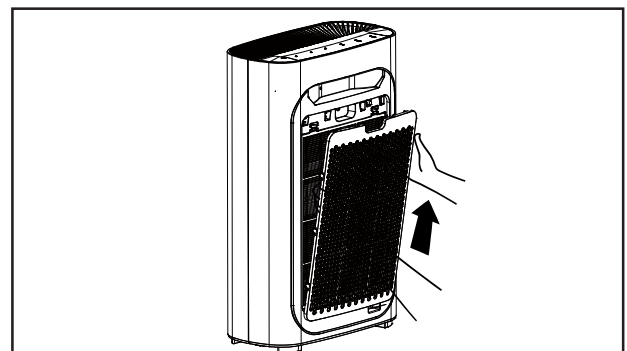

# Cleaning and maintenance

4. Take off all filters inside.

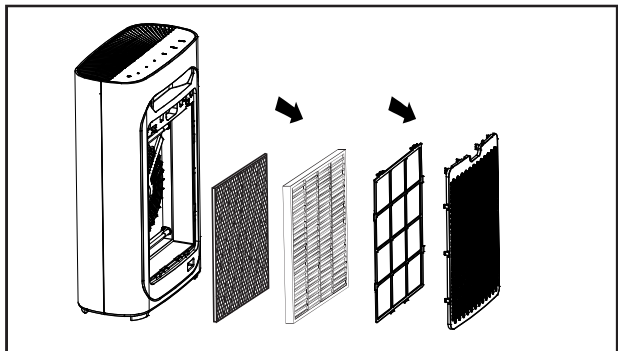

5. Remove all the plastic package of the filters, put back into the purifier.

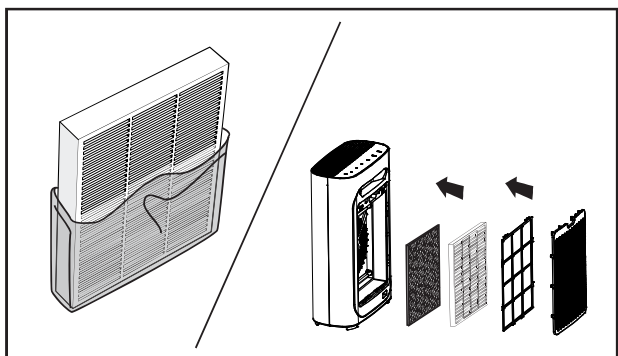

6. Put back the pre-filter into the purifier.

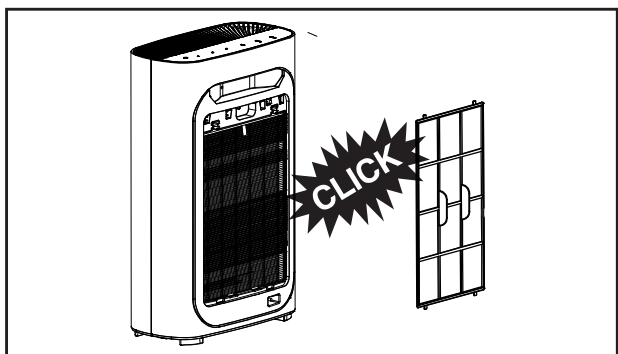

7. Re-install the front panel, keep alignment and inserted into the fixed groove, then gently push it up

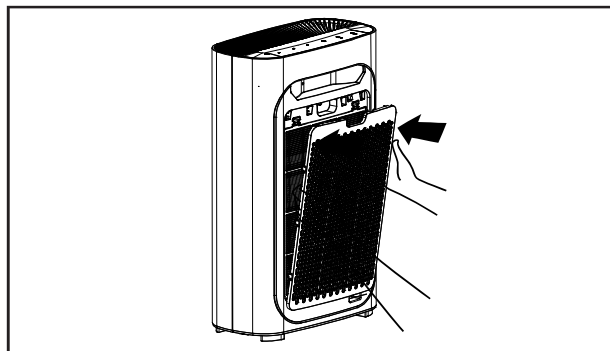

8. After replacing the filter, plug in power, hold on the reset button for 5 seconds, then machine resets.

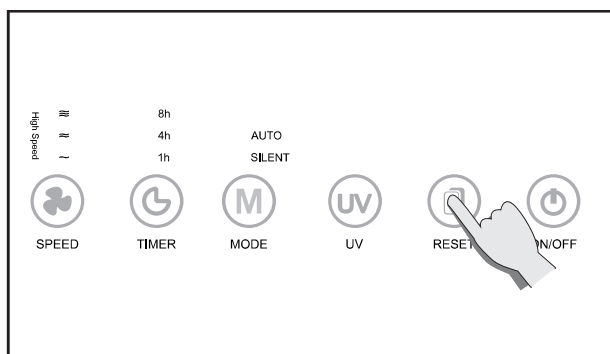
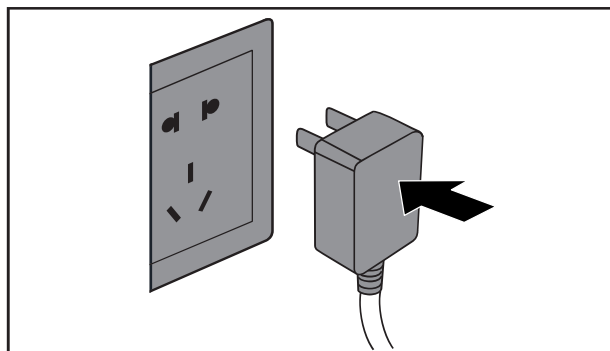

# Cleaning and maintenance

## Unused for a long time

Pull out the power plug. (because the power consumption happened when it is standby.)

Thoroughly dry the inside. (otherwise it may lead to the equipment trouble.)

Store the machine in a dry ventilated place. (lay flat or place upright down may lead to the product trouble.)

## Replace filter reference time

When the total machine work time reach to 1600hours, the machine will notice to change the filter. The power indicator will flash ceaselessly(one time per second). The red light showed when it is standby, the blue light showed when it works. But the machine still can work when get the notice of changing the filter.

### Tips

1. Consider you and your family's health, please change the filter screen in time.
2. After sealing off filter, if the usage time has shortened we suggest to change one-time per six months.
3. After sealing off filters, the filter should be changed one time per 12 months.

### Attention

Please turn off or Pull out the plug, before you change the filter.

# Fault handling

This chapter list the possible problems when using this product. If you can't solve the problems based on the below information, please contact with our customer center or dealers.

Condition	Possible reasons	Possible solutions
Machine can't turn on	The front panel may not be installed.	To remove the front panel, then install the panel again.
	Power plug is not inserted into the power source	Pull out the power plug, then insert into the power source.
	The power plug or wire is damaged.	Contact with our customer center or dealers.
The fan doesn't work	The machine is not turned on.	Insert the power source, and turn on the machine again.
	The dynamo is damaged.	Contact with our customer center or dealers.
	The machine is put on the uneven place.	Remove the machine to the flat place.
	Loose or foreign particles inside the machine.	Contact with our customer center or dealers.
	The motor is loose.	Contact with our customer center or dealers.
	Plastic packaging of each filter is not removed.	Before using, please remove plastic packaging of each filter.
Performance is poor or not best purification ability	Washable mesh filter is dirty.	Please clean the cleaning mesh filter.
	Filter has not been replaced.	Replace one set of new filters.
	Machine inlet or outlet was blocked.	Contact with our customer center or dealers.
	Plastic packaging of each filter is not removed.	Before using, please remove plastic packaging of each filter.
	The gap round the machine is not proper.	To ensure the machine at least 50 cm clearance on both sides of the air inlet and the outlet at the back of the machine at least 10 cm.
	Machine filter missing or sequence error.	To ensure that all the filters are on the correct sequence in the machine.
	Exceed the expect cover area.	To ensure the machine work in the suitable area.

# Additional

## Warranty and service

If you need to understand information or have any questions, you can also contact our customer service center or dealer.

Product warranty terms refer to the instruction attached warranty card in detail.

## Ordering parts or accessories

If you need to replace parts or need to purchase additional parts, please contact your customer service or dealer.

## Select accessories

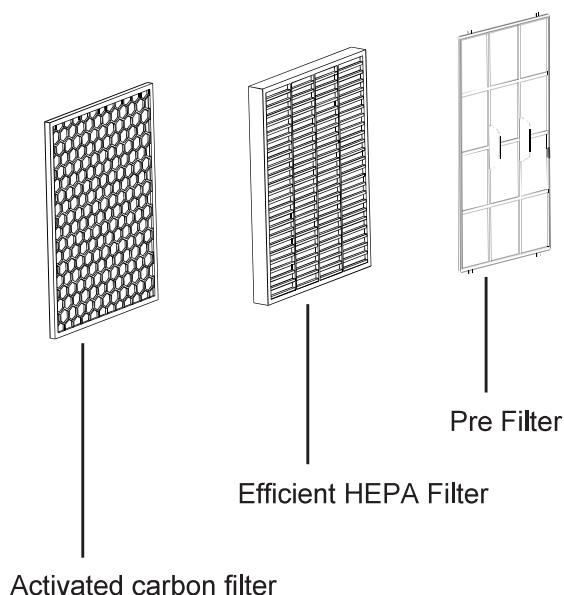

## recycling



Place the product, please don't put together with the general life garbage. Please check the local regulations on classified collection of electronic and electrical products.

Right place old product helps to avoid the potential negative effects on the environment and human health.

### **Special statement**

If the product has faults, please contact with the repair outlets. If the repair shop can not solve the problem, please contact with our customer service center directly.

All contents of the data are carefully checked, if there is any printing error or the content of the misunderstanding, the company reserves the right of explanation. If the products have improved technology, will issue a new version of the specification. The color can be changed, please make the objects the standard.