

MARVIN SERIES

SIH + SOH-09BIM

SIH + SOH-12BIM

SIH + SOH-18BIM

SIH + SOH-24BIM

„ORIGINAL INSTRUCTIONS“

IMPORTANT NOTE:

Read this manual carefully before installing or operating your new air conditioning unit. Make sure to save this manual for future reference.

EN

For downloading manual for this product, please enter the model name at this link:

**SK**

Pre stiahnutie manuálu k tomuto produktu zadajte modelové označenie do nasledujúceho odkazu:

**HR**

Za preuzimanje priručnika za ovaj proizvod unesite naziv modela na ovu vezu:

**SL**

Za prenos navodil za uporabo tega izdelka, vnesite ime modela na tej povezavi:

**IT**

Per scaricare il manuale di questo prodotto, inserisci il nome del modello a questo link:

**CZ**

Pro stažení manuálu k tomuto produktu zadejte modelové označení do následujícího odkazu:

**DE**

Um das Handbuch für dieses Produkt herunterzuladen, geben Sie bitte den Modellnamen für diesen Link ein:

**HU**

Termék kézikönyvének letöltéséhez írja be a modell megnevezését az alábbi linkre:

**RU**

Чтобы загрузить руководство для этого продукта, введите обозначение модели по следующей ссылке:

**ES**

Para descargar el manual de este producto, ingrese la designación del modelo en el siguiente enlace:



Explanation of symbols



WARNING

This symbol indicates the possibility of death or serious injury.



CAUTION

This symbol indicates the possibility of injury or damage to property.

NOTICE

Indicates important information. Failure to observe it may result in damage to property.

Disclaimer

The manufacturer shall bear no liability for any injury and/or property loss caused by the following:

1. Damage to the product due to its misuse or mishandling.
2. Modification, alteration and/or maintenance of the product and/or its use with other equipment contrary to the manufacturer's instructions.
3. Upon verification that the product defect is directly caused by corrosive gas.
4. Upon verification that the defect is caused by improper handling during transportation of the product.
5. Operation, repair and/or maintenance of the unit without following the operating instructions and/or relevant regulations.
6. Upon verification that the problem and/or dispute is caused by the quality and/or performance of components and/or parts manufactured by other manufacturers.
7. Damage is caused by natural disasters, improper operating environment and/or force majeure.





If installation, relocation and/or repair of the air conditioner is required, please contact your dealer or local service centre first. An air conditioner must only be installed, relocated and/or repaired by an authorized company. Otherwise, serious damage, personal injury or death may occur.

If refrigerant leaks and/or needs to be extracted during installation, maintenance and/or disassembly of the equipment, contact a suitably qualified professional or take other appropriate action in accordance with local codes and regulations.

This equipment should not be operated by persons (including children) with impaired physical, sensory and/or mental abilities and/or lack of the necessary knowledge and/or experience unless they are supervised and/or instructed about the operation of the equipment by a person responsible for their safety.

Children should be supervised so that they do not play with the equipment.

Refrigerant

 <p>The equipment is filled with flammable refrigerant R32.</p>	 <p>Read the installation instructions first before installation.</p>
 <p>Read the operating instructions first before use.</p>	 <p>Read the service manual first before repairing.</p>

- To ensure the functionality of the air conditioner, a special refrigerant is circulated in the system. The refrigerant used is R32 fluoride, which is specially purified. The refrigerant is flammable and odourless. If it leaks accidentally, it can explode under certain conditions. However, the flammability of the refrigerant is very low. It can only be ignited by fire.
- Compared to conventional refrigerants, R32 is a non-polluting refrigerant and does not damage the ozone layer. It also has a low greenhouse effect. R32 has very good thermodynamic properties. As a result, very high energy efficiency can be achieved. The equipment therefore needs a smaller refrigerant charge.

WARNING

Do not use any means other than those recommended by the manufacturer to accelerate the defrosting process and/or to clean the equipment. If repair is required, contact the nearest authorized service centre. Any repairs carried out by unqualified persons can be dangerous. The equipment should be located in a room where there is no permanent risk of ignition of flammable substances (for example, an open fire, a running gas burner and/or an electric heater with hot coils). Do not puncture the refrigerant pipe and/or throw it into a fire. The equipment is to be installed, operated or stored in a room with a floor area greater than $X \text{ m}^2$. (For area size X, see table "a" in the section "Safe handling of flammable refrigerant".) The equipment is filled with flammable refrigerant R32. Follow the manufacturer's instructions exactly when carrying out repairs. Keep in mind that the refrigerant may not give off any odour. Read the specialist instructions.



- This equipment should not be operated by persons (including children) with impaired physical, sensory and/or mental abilities and/or lack of the necessary knowledge and/or experience unless they are supervised and/or instructed about the operation of the equipment by a person responsible for their safety. Children should be supervised so that they do not play with the equipment.

- 1) The WiFi module operates in the 2400-2483.5 MHz frequency band.
- 2) The maximum transmission power in this band is 20 dBm.



R32: GWP 675

This designation means that this product must not be disposed of in normal municipal waste. Please recycle it responsibly to prevent damage to the environment and

human health that may occur when the product is disposed of improperly, and to contribute to the sustainable reuse of natural resources.

To dispose of used equipment, use the appropriate waste collection service or contact the dealer from whom the product was purchased. They can take the product and recycle it in an environmentally friendly way.

If installation, relocation and/or repair of the air conditioner is required, please contact your dealer or local service centre first. An air conditioner must only be installed, relocated and/or repaired by an authorized company. Otherwise, serious damage, personal injury or death may occur.

Safe handling of flammable refrigerant

Qualification requirements for installers and maintenance workers

- All personnel working on air conditioning systems should have a valid certificate issued by an authorised organisation and a qualification for working with refrigeration systems recognised in the industry. If other technicians are required to maintain and/or repair the equipment, they should be supervised by a person qualified in the use of flammable refrigerants.
- The equipment should only be repaired in accordance with the procedure recommended by the equipment manufacturer.

Installation notes

- The air conditioner may only be installed in a room that has more than the minimum floor area. The minimum room area is indicated on the nameplate or in the following table.
- It is forbidden to drill holes in the refrigerant pipe and/or to throw it into a fire.
- After installation, a test must be carried out to ensure that no refrigerant leaks from the equipment.

Table a: Minimum room area (m²)

Refrigerant charge (kg)	Floor installation	Window installation	Wall installation	Ceiling installation
≤1.2	/	/	/	/
1.3	14.5	5.2	1.6	1.1
1.4	16.8	6.1	1.9	1.3
1.5	19.3	7	2.1	1.4
1.6	22	7.9	2.4	1.6
1.7	24.8	8.9	2.8	1.8
1.8	27.8	10	3.1	2.1
1.9	31	11.2	3.4	2.3
2	34.3	12.4	3.8	2.6
2.1	37.8	13.6	4.2	2.8
2.2	41.5	15	4.6	3.1
2.3	45.4	16.3	5	3.4
2.4	49.4	17.8	5.5	3.7
2.5	53.6	19.3	6	4

Maintenance notes

- Check that the maintenance area and room floor area meet the requirements specified on the nameplate.
 - The equipment may only be operated in rooms that meet the requirements on the nameplate.
- Check that the maintenance area is well ventilated.
 - Constant ventilation must be ensured during work.

- Check that the maintenance area is free of open fire and/or potential sources of fire.
 - There must be no open fire in the maintenance area and a “No Smoking” warning sign must be displayed.
- Check that the labels on the equipment are in good condition.
 - Replace warning signs that are not visible or are damaged.

Soldering

- If you have to cut and/or solder the pipes of the refrigerant system during maintenance, follow the steps below:
 - a) Switch off the equipment and disconnect it from the power supply.
 - b) Extract the refrigerant.
 - c) Evacuate.
 - d) Clean the tubes with nitrogen gas (N₂).
 - e) Perform cutting and/or soldering.
 - f) Put the equipment into operation.
- Refrigerant for recycling must be stored in a special container.
- Make sure that there is no open fire near the vacuum pump exhaust and that the area is well ventilated.

Refilling the refrigerant

- When filling, use equipment that is designed exclusively for R32 refrigerant. Make sure that the different types of refrigerants do not contaminate each other. When filling the refrigerant, the refrigerant container should be in an upright position.
- When filling is complete, affix a label to the equipment with the details of the refrigerant added.
- Take care not to overfill the refrigerant.
- Check for refrigerant leaks after completion of filling and before test operation. A refrigerant leak check should also be carried out when the equipment is relocated.

Safety instructions for transport and storage

- Before unloading the equipment and opening the shipping package, check with a flammable gas detector.
- There must be no open fire in the area. Do not smoke.
- Observe local regulations and laws.

Safety precautions



WARNING

Installation

- Installation and maintenance must be carried out by suitably qualified personnel.
 - The equipment must be installed in accordance with applicable state electrical standards, decrees and regulations.
 - Use a separate power supply circuit and circuit breaker with the required parameters according to the relevant safety regulations.
 - All wiring for indoor and outdoor units must be installed by a professional.
 - Disconnect the power supply before starting any work on the electrical equipment.
 - Check that the power supply meets the requirements of the air conditioner.
 - An unstable power supply and/or improper connection may cause electric shock, fire and/or malfunction.
- Install the appropriate power cords before using the air conditioner.
 - Ground resistance must comply with applicable electrical safety standards.
 - The air conditioner must be properly grounded. Improper grounding may cause electric shock.
 - Do not connect the power supply until installation is complete.
 - Install a circuit breaker. Otherwise, the equipment may be damaged.
 - When permanently connected to the power supply, a switch that disconnects all poles and whose contacts are at least 3 mm apart in the off state must be used to switch off the unit.
 - The circuit breaker must protect against short circuit and overload.

Safety precautions



CAUTION

Installation

- Instructions for installation and use of this product are provided by the manufacturer.
- Select a location that is out of reach of children and away from animals and plants. If necessary for safety reasons, erect a fence around the unit.
- The indoor unit should be installed close to the wall. Do not use an unsuitable power cord.
- If the length of the power connection cable is not sufficient, ask your supplier for a new cable of sufficient length. The equipment must be positioned so that its electrical plug is easily accessible.
- If the air conditioner is connected via a plug, the plug should be easily accessible after installation.
- For an air conditioner without a plug, a switch (disconnect) or circuit

breaker must be connected in the circuit.

- The green+yellow wire in the air conditioner is a ground wire that must not be used for other purposes.
- The air conditioner is a Class I electrical device. It must be properly grounded according to the applicable standards. The earthing connection must be made by a qualified professional. Make sure to check the functionality of the earthing at all times, otherwise electric shock may occur.
- The temperature in the cooling circuit may be high. Route the connecting cable at a sufficient distance from the refrigerant tubes.

Safety precautions



WARNING

Operation and maintenance

- This equipment may also be used by children over 8 years of age and persons with reduced physical, sensory and/or mental abilities, or persons with insufficient experience and/or knowledge, provided they are supervised and/or have been instructed about the safe use of the equipment and are aware of the possible risks.
- Children must not play with the equipment. Cleaning and user maintenance of the equipment must not be carried out by unsupervised children.
- If the power cord is damaged, it must be replaced by the manufacturer, an authorised service centre or a suitably qualified person to reduce the potential risk. Do not use an extension cord with multiple outlets or a socket splitter for connection. Otherwise, there is a risk of fire.
- Disconnect the air conditioner from the power supply before cleaning. Otherwise, electric shock may occur.
- Do not wash the air conditioner with water, otherwise there is a risk of electric shock.
- Do not spray water on the indoor unit. Doing so may result in electric shock and/or damage to the equipment.
- Do not repair the air conditioner yourself. Doing so may result in electric shock and/or damage to the equipment. Contact your dealer.
- After removing the filter, do not touch the fins of the heat exchanger to avoid cutting yourself on the sharp edges.
- Do not stick your fingers and/or any objects into the air inlet and/or outlet vents. Doing so may cause personal injury or damage to the equipment.

Safety precautions



CAUTION

Operation and maintenance

- Do not pour water on the remote control, otherwise the remote control may be damaged.
- Do not use fire and/or a hair dryer to dry the filter, otherwise deformation of the filter and/or fire may occur.
- Do not block the air inlet and/or outlet. A malfunction could occur.
- Do not climb on the top panel of the outdoor unit or place heavy objects on it. This could result in equipment damage and/or personal injury.
- If the following conditions occur, switch off the air conditioner immediately and disconnect the power supply. Ask your dealer or authorized service centre for repair also if the following occurs:
 - The power cord is overheating or damaged.
 - Abnormal noise during operation.

- Circuit breaker trips frequently. The air conditioner smells like something is burning.
- Refrigerant is leaking from the indoor unit.

Use of UV-C lamp

WARNING

This equipment contains a C-type UV emitter. Do not stare at the light source.

- This equipment contains a UV-C lamp.
- Read the maintenance instructions before opening the equipment.
- Instructions for cleaning and other user maintenance of the equipment:
 - ① Prior to cleaning or other maintenance, the equipment must be disconnected from the power supply.
 - ② Open the panel and take out the filter.
 - ③ Clean the quartz glass with a soft cotton cloth.
 - ④ Clean and reinstall the filter and then close the panel cover.
- Method and frequency of cleaning and necessary safety precautions to be observed:

Cleaning method: Wipe the quartz glass with a soft cloth until the surface is clean.

Cleaning frequency: Clean the glass every 6 months; you can adjust the cleaning frequency according to the level of air pollution.

Preventive measures:

 - ① Before cleaning, the unit must be turned off and the power disconnected. Otherwise, it may cause electric shock and damage to health by UV.
 - ② Do not use volatile substances, alcohol, thinners or varnishes to clean the UV-C lamp. Otherwise, the UV-C lamp may be damaged.
 - ③ Do not touch the fins of the indoor unit heat exchanger to avoid injury.
 - ④ Do not scratch the glass surface when wiping it.
- Unintentional use of the equipment or damage to the cover may result in the release of dangerous UV-C radiation. UV-C radiation may, even in small doses, cause damage to the eyes and skin.
- Do not use equipment that is obviously damaged.
- When performing user maintenance, it is recommended to disconnect the power supply before opening covers and access panels with the symbol "Danger of UV radiation".
- UV-C barriers marked with the "Danger of UV radiation" symbol should not be removed.

- Do not use UV-C lamps outside the equipment.

WARNING

Do not use the UV-C emitter if it is removed from the equipment.



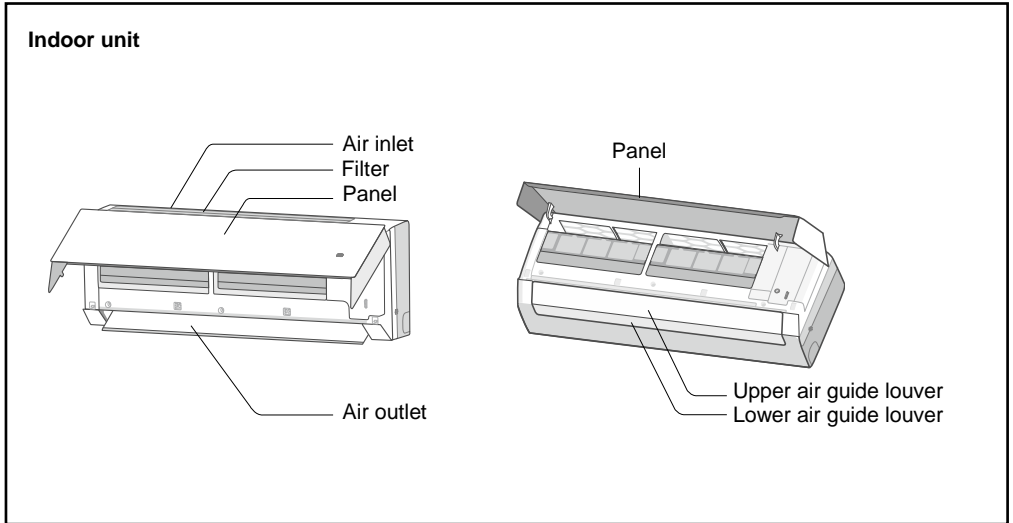

- To avoid dangerous situations, the user must not change the UV-C emitter. Replacement must be carried out by qualified personnel from the manufacturer or service centre.

Part names

Indoor unit



Display

Heat mode	
Cool mode	
Dry mode	
Temperature indicator	26
Power indicator	
Humidity indicator	%

NOTICE

- This is the general description. The colour of indicator may be different. Please refer to the actual display.
- Display content may be different from the actual display. Please refer to the actual display.

Remote control

Buttons on the remote control





Meaning of indicators on display

	Quiet	
	Set fan speed	
	Turbo mode	
	Send signal	
Operation mode		Auto mode
		Cool mode
		Dry mode
		Fan mode
		Heat mode
	X-FAN function	
	Humidity control	
	Power limiting operation	
	Set temperature	
	Indoor ambient temperature	
	Indoor ambient humidity	
ONOFF	TIMER ON/TIMER OFF	
	Set time	
	Left & Right Swing	
	Up & Down Swing	
	Child Lock	
	Fast cooling	
	Health and UVC function	
WiFi	WiFi function	
	LED	
	Auto LED	
	I FEEL	
	Sleep mode	

Remote control button functions

NOTICE

- This remote control is universal. It can be used for air conditioners with many functions. If a function button is pressed on the remote control that the model does not have, the unit will maintain its original operating status.
- When the air conditioner is connected to the power supply, a beep will sound. The power indicator  is on. You can then operate the air conditioner using the remote control.
- When the unit is switched on, after pressing the button on the remote control, the signal transmission indicator  flashes once on the remote control display and a tone sounds from the air conditioner to confirm that it is receiving the signal.







On/Off button

Press this button to switch the unit on. Press the button again to switch the unit off.

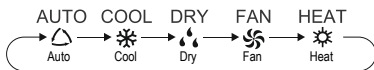
Mode button

Press this button to set the desired operation mode for this cycle:









- When you select the Auto mode, the air conditioner will operate automatically according to the measured temperature. Press the Fan button to set the fan speed. Press the  button to set the air blowing angle.
- When you select Cool mode, the air conditioner will operate in Cool mode. Press the + or - button to set the desired temperature. Press the Fan button to set the fan speed. Press the  button to set the air blowing angle.
- When you select Dry mode, the air conditioner will operate in Dry mode with low fan speed. Fan speed cannot be adjusted in Dry mode. Press the  button to set the air blowing angle.
- When you select Fan mode, the air conditioner will only blow air, it will not cool or heat. All indicators are off. Press the Fan button to set the fan speed. Press the  button to set the air blowing angle.
- When you select Heat mode, the air conditioner will operate in Heat mode. Press the + or - button to set the desired temperature. Press the Fan button to set the

fan speed. Press the  button to set the air blowing angle.

NOTICE

- To prevent cold air from blowing out when Heat mode is started, the indoor unit will start blowing out air with a delay of 1-5 minutes (the delay time depends on the room temperature).
- Temperature setting range via remote control is 16-30 °C.
- There is no indicator for this mode on some models.
- An air conditioner that has only the Cool function cannot operate in Heat mode. If Heat mode is selected by the remote control, the air conditioner cannot be switched on using the On/Off button.

Fan button (Fan speed)

This button is used to set the fan speed in this cycle: AUTO,  (Quiet),  (Low),  (Low-Medium),  (Medium),  (Medium-High),  (High) to  (Turbo), and then back to AUTO.

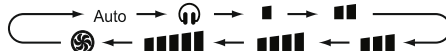

NOTICE

- In Dry mode, the fan runs only at a low speed.
- X-FAN function: When you press the fan speed button for 2 seconds in Cool or Dry mode, the indicator  will be displayed and the fan will run for a few more minutes after the unit is switched off to dry the inside of the unit. When power is connected, the X-FAN function is switched off by default. The X-FAN function cannot be used for Auto, Fan or Heat mode. This function allows the moisture on the evaporator of the indoor unit to dry out after the unit is switched off to prevent mould growth.
- When the X-FAN function is on: After the unit is switched off by pressing the On/Off button, the indoor unit fan will continue to run at a low speed for several minutes. During this time, the indoor unit fan can be stopped directly by pressing the fan speed button for 2 seconds.
- When the X-FAN function is off: After the unit is switched off by pressing the On/Off button, the entire unit stops immediately.

+ / - button (Increase/Decrease)

Press the + or - button once to increase or decrease the set temperature by 1 °C. If you hold the + or - button for 2 seconds, the set temperature on the remote control will change rapidly. If you release the button when the desired value is reached, the change will also appear on the display of the indoor unit.



Wifi button

Press the WiFi button to switch on the WiFi function. The WiFi indicator appears on the remote control. When you press and hold the WiFi button for 5 seconds, the WiFi function switches off and the WiFi indicator disappears. When the equipment is off and the Mode and WiFi buttons are pressed simultaneously for 1 second, the WiFi module resets to factory settings.

NOTICE

- This function is only available on some models.



Health button

Press this button during operation to switch the Health function or UVC lamp on/off.

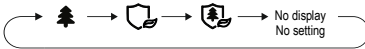

- If you select (Health) on the remote control, the ion generator will switch on.
- If you select on the remote control, the sterilization using the UVC lamp will switch on.
- If you select on the remote control, the ion generator and UVC lamp sterilization will switch on.

NOTICE

- The Health function and UVC lamp sterilization are only available on some models.



UD-swing button

Press this button to select up & down swing angle in the following cycle:

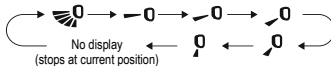

- When you select , the air conditioner directs the blown air automatically. The horizontal guide louver will automatically swing up and down at the maximum angle.
- When you select , , , , or , the air conditioner blows air only in the set direction. The guide louver will stop in the specified position.
- To set the desired swing angle, press and hold the button for more than 2 seconds. Release the button when the desired angle is reached.

NOTICE

- If you press and hold this button for more than 2 seconds, the guide louver will start to turn up and down. When you release the button, the guide louver will immediately stop at the current position.
- Under up and down swing mode, if you switch the swing function on using the button and press this button again after 2 seconds, the swing function will switch off. If you press this button again within 2 seconds, the swing function will also be changing according to the cycle above.



Humidity button

In Cool mode, press this button to select humidity control with Cool mode, smart dehumidification with Cool mode or general Cool mode in the following cycle:

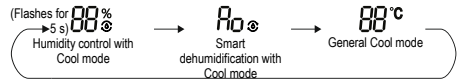

- When humidity control with Cool mode is set, the remote control displays and the humidity value “88”, and the “%” indicator flashes for 5 seconds; during this time, you can use the + or - button to set the desired humidity value. Under humidity control in Cool mode, the humidity setting range on the remote control is 40-80%. Under humidity control in Cool mode, the desired temperature can be set.
- When smart dehumidification is set in Cool mode, the remote control will display ; on the remote control and indoor unit, “Ao” will be displayed for 5 seconds. Under smart dehumidification in Cool mode, the desired temperature can be set.
- The humidity for smart dehumidification is automatically adjusted to be comfortable for the human body; there is no need to adjust the humidity manually.

Under Dry mode, press this button to select humidity control with Dry mode, continuous dehumidification mode or general dehumidification mode in the following cycle:



- When humidity control with Dry mode is set, the remote control displays , “%” and the humidity value “88”; you can use the + or - button to set the desired humidity value. Humidity setting range via remote control is 30–70 %.

Under humidity control in Dry mode, the desired temperature cannot be set.

- When continuous dehumidification is set, the remote control will display ; on the remote control and indoor unit, "Co" will be displayed. The temperature cannot be set in continuous dehumidification mode.
- In continuous dehumidification mode, the unit always operates in the Dry state; there is no need to adjust the temperature and/or humidity.

NOTICE

- The air conditioner is primarily used for temperature control; humidity control is an auxiliary function. Humidity is affected by factors such as indoor and outdoor environment, the degree of indoor air tightness, and indoor airflow.
- If the set humidity is higher than the current air humidity, the set humidity cannot be achieved.
- If the humidity sensor has a fault, the humidity setting in Cool or Dry mode is ignored and the unit operates in general Cool or Dry mode.



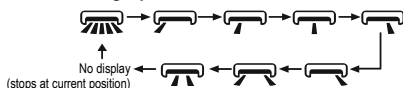

LR-swing button

Press this button to select left & right swing angle in the following cycle:



NOTICE

- If you press and hold this button for more than 2 seconds, the guide louver will start to swing back and forth from left to right. When you release the button, the louver will immediately stop at the current position.
- Under left and right swing mode, if you switch the swing function on using the  button and press this button again after 2 seconds, the swing function  will switch off. If you press this button again within 2 seconds, the swing function will also change according to the cycle above.
- This function is only available on some models.



button

- When the unit is on, press this button once to set Timer OFF. Indicators HOUR and OFF will flash. Within 5 seconds, press the + or - button to set the time ON. Each time the + or - button is pressed, the set time will increase or decrease by 0.5 hour. If you hold down the + or - button for 2 seconds, the set time will start to change rapidly. Release the button when the desired time is reached. Press the Timer

button to confirm the setting. Indicators HOUR and OFF will stop flashing.

Cancel Timer OFF: In the Timer OFF state, press the Timer button again.

- When the unit is off, press this button once to set Timer ON. For the detailed procedure, see Timer OFF.



Cancel Timer ON: In the Timer ON state, press the Timer button again.

NOTICE

- Time setting range: 0.5–24 hours
- The interval between button presses during setting must not exceed 5 seconds. Otherwise, the remote control will automatically exit the setting mode.



button

Press this button to select the Sleep function in the following cycle: Sleep 1 () , Sleep 2 () , Sleep 3 () or Off. When power is connected, the Sleep function is switched off by default.

- Sleep 1 mode
 - In Cool mode: When Sleep 1 mode is on, the set temperature will increase by 1 °C after 1 hour and the set temperature will increase by 2 °C after 2 hours. The unit then continues to operate at this set temperature.
 - In Heat mode: When Sleep 1 mode is on, the set temperature will decrease by 1 °C after 1 hour and the set temperature will decrease by 2 °C after 2 hours. The unit then continues to operate at this set temperature.
- Sleep 2 mode

In this mode, the air conditioner will operate according to the factory preset temperature waveform (group of temperature curves) for sleep mode.
- Sleep 3 mode

In this mode, the air conditioner will operate according to the user-set temperature waveform (temperature curve) for sleep mode.

 - (1) In Sleep 3 mode, hold down the Health button to switch the remote control to the user-set temperature waveform mode. The display of the remote control will show 1 hour in the clock field and the last set temperature for sleep mode will flash in the temperature setting field (for the first setting, this will be the temperature preset by the manufacturer).
 - (2) Use the + or - button to change the respective set temperature. Confirm the setting by pressing the Health button.

- (3) After this operation, the time in the clock field will automatically increase by 1 hour (i.e. to 2 hours and in subsequent cycles gradually to 3 to 8 hours) and the corresponding last set temperature will flash in the temperature setting field.
- (4) Repeat steps 2 and 3 until the desired temperature setting for the 8th hour of the sleep waveform is completed. This completes the sleep temperature waveform setting. The remote control display will resume displaying the current time and temperature settings.

- Check the user temperature waveform setting for Sleep 3 mode:

Follow the same procedure as for setting. Call up the user temperature waveform setting mode, but do not change the temperature and just confirm it by pressing the Health button. Note: If no button is pressed for 10 seconds while setting or viewing the temperature waveform values, the setting or viewing will automatically stop and the remote control display will resume the basic display. You can also terminate setting or viewing the temperature waveform values by pressing the On/Off, Mode, Timer or Sleep button.

LIGHT button

Press this button to control the LED display function in the following cycle:

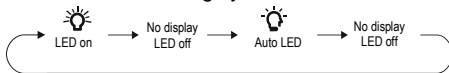

When you select (Auto LED) using the remote control, the brightness of the LED indication on the indoor unit will be adjusted automatically according to the ambient light intensity.

Button combination functions

Energy Saving function

In Cool mode, press the Mode and Timer buttons at the same time to activate or deactivate the Energy Saving function. When the Energy Saving function is activated, "SE" will appear on the remote control display and the air conditioner will automatically adjust the set temperature to the factory setting to achieve the best energy saving effect. In Cool mode, press the Mode and Timer buttons at the same time again to deactivate the Energy saving function.

NOTICE

- In Energy Saving mode, the fan speed is set to automatic by default and cannot be changed.
- In Energy Saving mode, the set temperature cannot be changed.
- Sleep and Energy Saving functions cannot be used at the same time. If the Energy Saving function is on in Cool mode, the Energy Saving function will be switched off when the Sleep button is pressed. If the Sleep function is on in Cool mode, the Sleep function will be switched off when the Energy Saving function is activated.

Child Lock function

Press the On/Off and - buttons simultaneously to switch the Child Lock function on or off. When the Child Lock function is switched on, indicator will be displayed. When you press the button on the remote control, indicator will flash three times without sending a signal to the unit.

Temperature display switchover function

When the unit is off, you can switch between displaying the temperature in °C and °F by pressing the Mode and - buttons simultaneously for 3 seconds.

Power limiting function

function is for limiting power of the whole unit. Press the Mode and Sleep buttons simultaneously to change the function in the following cycle:

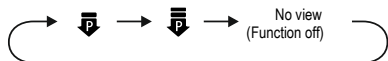

- The maximum power limitation in mode is lower than that in mode .
- To cancel the power limiting function, press the Mode and Sleep buttons repeatedly at the same time until the function indicator on the remote control disappears.
- When the unit is turned off using the remote control, the power limiting function is cancelled. To activate it, press the above buttons again.
- If the current power is lower than the maximum power in mode , the power will not be limited when such mode is activated.
- The function in the system with one outdoor unit and two indoor units: If either indoor unit enters the power limiting mode, the outdoor unit's power will be limited according to the setting of that indoor unit; if both indoor units enter the power limiting mode, the outdoor

unit's power will be limited according to the lower power setting of both indoor units.



NOTICE

- This function is only available on some models.

Indoor ambient temperature/humidity display

Press and hold the On/Off and  buttons simultaneously to display the indoor temperature or humidity on the indoor unit display. The cycle selection on the remote control is as follows:





- If you select  using the remote control, the indoor unit numeric display will show the temperature in the room.
- If you select  using the remote control, the indoor unit numeric display will show the humidity in the room.

NOTICE

- The humidity value is only indicative. Example: If the humidity value is "0%", it may indicate a malfunction of the humidity detection board. Contact your local service.
- There may be some measurement deviation with regard to the humidity and light intensity detection.

Filter cleaning reminder

The filter cleaning reminder function is disabled by default. Press and hold the On/Off and  buttons simultaneously for 5 seconds to turn it on. An audible signal will sound for 0.5 seconds and the numeric display will light up for 3 seconds. When the cleaning reminder function is switched on and the air conditioner run time reaches the set value, the numeric display will flash for about 30 seconds each time the unit is switched on to remind the user to clean the filter. This cleaning cycle reminder can be switched off by simultaneous pressing and holding the On/Off and  buttons for 5 s; then the unit will start counting the run time again.

NOTICE

- Once the cleaning reminder function is switched on, only this cleaning cycle reminder can be cancelled.
- This function is only available on some models.

Volume control of indoor unit buzzer

Press the Mode and  buttons simultaneously to lower the volume of the indoor unit buzzer.

NOTICE

- This function is only available on some models.

Fast Cool function

Press the On/Off and + buttons simultaneously in the Cool mode to switch between the following modes: fast cooling 25 °C, fast cooling 16 °C and normal cooling. In Fast Cool mode, indicator  on the remote control will be displayed.

When you enter the Fast Cool mode, automatic fan speed and the temperature of 25 °C or 16 °C will be set. The set temperature will flash on the display for 5 seconds. During the flashing, you can use the + or - button to set the desired temperature. Press the Fan button to set the fan speed. If the set temperature and fan speed are not changed during this time, the remote control and indoor unit will operate according to the current set temperature and fan speed for 20 minutes. After 20 minutes, the set temperature and fan speed for the remote control and indoor unit will change to the state before the Fast Cool function was activated.

NOTICE

- If the set temperature or fan speed is changed during operation in the Fast Cool mode, the Fast Cool mode is terminated. The indoor unit then continues to operate according to the set state.
- The Fast Cool function can only be used on some models. If this function is not available for this indoor unit, the remote control will return to the state before the Fast Cool mode after 20 minutes. The indoor unit continues to operate according to the current state. During this time, the state of the indoor unit and the state displayed on the remote control may differ.
- This function is only available on some models.

Auto Clean function

When the unit is off, press the Mode and  buttons simultaneously for 5 seconds to switch the Auto Clean function on or off. When the Auto Clean function is on, the display of the indoor unit will show "CL". During the automatic evaporator cleaning process, the unit will carry out rapid cooling or rapid heating. Some noises may be heard, such as those caused by flowing refrigerant or thermal expansion/contraction of parts. Cold or warm air may be blowing from the air conditioner, which is normal. Ensure sufficient ventilation of the room during the cleaning process to avoid disturbance of comfort.

Replacing the batteries in the remote control

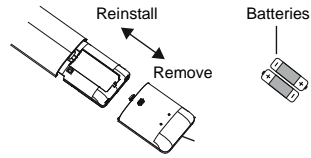

1. Press the back of the remote control at the point marked , as shown in the picture, and then slide out the battery compartment cover in the direction of the arrow.
2. Replace two 1.5V AAA batteries. Make sure that the + and - orientation of the poles of the batteries is correct.
3. Reinstall the battery cover.

NOTICE

- During operation, point the remote control signal transmitter at the receiver window on the air conditioner.
- The distance between the signal transmitter and the receiver window should be no more than 8 m and there should be no obstacles in the signal path.
- In a room with fluorescent lighting and/or a cordless telephone, interference with the signal may occur. In this case, the remote control should be brought closer to the indoor unit.
- When replacing the batteries, use the same type of batteries.
- Remove the batteries from the remote control if you are not going to use it for a long time.
- Replace the batteries if the indicators on the remote control display are hard to see or do not appear at all.

NOTICE

- The Auto Clean function can only operate at normal ambient temperatures. If there is a lot of dust in the room, perform cleaning once a month, otherwise once every three months. You can leave the room after the Auto Clean function is switched on. When the automatic cleaning is finished, the air conditioner will go into standby mode.
- This function is only available on some models.



Night mode

When the Sleep mode is switched on in Cool or Heat mode and the speed is set to low or silent, the outdoor unit will go into night mode.

NOTICE

- If you feel that the cooling or heating is not effective, switch the fan speed with the Fan button or press the Sleep button to exit the night mode.
- Night mode can only operate at normal ambient temperature.
- This function is only available on some models.

I FEEL function

Press the Health and + buttons simultaneously to activate the I FEEL function. Indicator  will appear on the remote control display. When this function is switched on, the remote control will send the temperature reading to the unit and the unit will automatically regulate the room temperature according to the temperature measured by the remote control sensor. To switch off the I FEEL function, press the Health and + buttons again simultaneously. Indicator  disappears.

- After switching on this function, place the remote control near the user so that the indoor unit can receive the signals sent by the remote control. Do not place it near an object with a high or low temperature, otherwise the ambient temperature measurement will not be correct.

Cleaning and maintenance

⚠ WARNING

- Before cleaning, switch off the air conditioner and disconnect it from the power supply to prevent electric shock.
- Do not wash the air conditioner with water, otherwise there is a risk of electric shock.
- Do not use volatile liquids to clean the air conditioner.
- Do not use liquid and/or aggressive cleaning agents and do not spray water or other liquids on the equipment to clean it, otherwise damage to plastic parts or even electric shock may occur.

Cleaning the surface of the indoor unit

When the surface of the indoor unit is dirty, it is recommended to use a soft dry or damp cloth to clean it.

NOTICE

- Do not remove the panel when cleaning.

Cleaning the filter

1. Remove the filter.

Press the spring fasteners on both sides of the filter in the direction indicated by the arrows. At the same time, lift the filter so that it separates from the fasteners. Pull the filter forward and remove it.

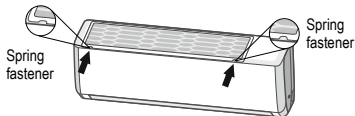

2. Clean the filter.

Clean the filter with a dust collector or wash it with clean water. If the filter is very dirty (e.g. greasy), use warm water (45 °C) with dissolved neutral detergent to clean it and then leave the filter in a shaded place to dry.

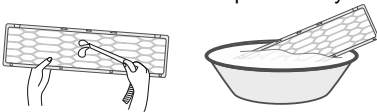

3. Install the filter.

After cleaning, reinstall the filter using the reverse procedure. Push it along the guide rails on both sides and then press the left and right edges of the filter. Reinstall the filter in the direction indicated by the arrows.

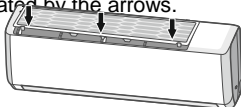

⚠ WARNING

- The filter should be cleaned once every three months. If the equipment operates in a dusty environment, the filter can be cleaned more frequently.
- After removing the filter, do not touch the fins of the heat exchanger to avoid cutting yourself on the sharp edges.
- Do not use fire and/or a hair dryer to dry the filter, otherwise deformation of the filter and/or fire may occur.

NOTICE: Pre-season inspection

1. Check that the air inlet and/or outlet vents are not blocked.
2. Check that the circuit breaker, power plug and socket are in good condition.
3. Check that the filter is clean.
4. Check the outdoor unit mounting base for damage and/or corrosion. If it is damaged, contact your dealer.
5. Check that the drain pipe is not damaged.

NOTICE: Inspection after season

1. Disconnect the power supply.
2. Clean the filter and panel of the indoor unit.
3. Check the outdoor unit mounting base for damage and/or corrosion. If it is damaged, contact your dealer.

Recycling information

1. Many packaging materials are recyclable. Dispose of them in the appropriate containers for recyclable waste.
2. If you wish to dispose of your old air conditioner, contact your local waste collection centre or ask your dealer for advice on how to properly dispose of the equipment.

Error code

When the air conditioner is in an abnormal condition, the temperature display on the indoor unit will flash to show the relevant fault code. Find the fault code in the table below.

Error code	Troubleshooting
U8, H6, H3, E1, E5, E6, E8	The fault indication may be cancelled after restarting the equipment. If not, contact the service centre.
C5, F0, F1, F2	Contact the service centre.

NOTICE

- If other fault codes appear, contact an authorized service centre.

Checks before repair

Analysis of common phenomena

Check the following items before requesting repair of the equipment. If you are unable to solve the problem, contact your local dealer or authorized service centre.

Phenomenon	Inspected item	Solution
The indoor unit is not receiving a signal from the remote control or the remote control is not working.	Is the operation of the unit seriously disturbed (e.g. by static electricity and/or unstable voltage)?	Disconnect the power plug from the power outlet. After 3 minutes, reconnect the plug and switch on the unit.
	Is the remote control close enough to the unit?	The signal range of the remote control is 8 m.
	Are there any obstacles in the way of the signal?	Remove the obstructions.
	Is the remote control pointed at the receiver window on the unit?	Point the remote control from a suitable angle at the signal receiver window on the indoor unit.
	Do the remote control buttons not work? Is the information on the display hard to see? Or does the information not show at all?	Check the batteries. If the batteries are low, replace them.
	The remote control does not work.	Check the remote control for damage. If it is damaged, replace it.
	Is there fluorescent lighting in the room?	Bring the remote control closer to the indoor unit. Switch off the fluorescent lighting and try again.
	No air is blowing from the indoor unit.	Is the air inlet/outlet of the indoor unit blocked?
In Heat mode: Has the room temperature reached the set point?		When the set point is reached, air stops blowing from the indoor unit.
Has the Heat mode just been started?		To prevent cold air from blowing out, the indoor unit fan will start after a few minutes. It is a normal phenomenon.
The air conditioner is not working.	Has there been a power failure?	Wait for the power supply to be restored.
	Is the plug loose?	Insert the plug into the socket.
	Has the circuit breaker tripped? Or is the fuse blown?	Ask a professional to check the circuit breaker and/or replace the fuse.
	Is the electrical wiring and/or power cord faulty?	Ask an electrician to repair it.
	Was the unit switched back on immediately after being switched off?	Wait 3 minutes and then switch the unit back on.
	Is the function setting using the remote control correct?	Set the function again.

Phenomenon	Inspected item	Solution
Steam is blown out of the indoor unit.	Is the room temperature and humidity high?	This is caused by the air in the room cooling down rapidly. After a while, the temperature and humidity decrease and the steam disappears.
There is an odour coming from the unit.	Is there a source of odour in the room, such as furniture, cigarettes, etc.?	Remove the source of the odour. Clean the filter.
It is not possible to set the desired temperature.	Does your desired temperature exceed the range of settable temperatures?	Temperature setting range: 16–30°C
Insufficient cooling (heating).	Is the supply voltage too low?	Wait until the correct voltage is restored.
	Is the filter dirty?	Clean the filter.
	Is the temperature set at the correct value?	Set the temperature correctly.
	Are doors or windows open?	Close the doors and windows.
The air conditioner is not working normally.	Has the unit operation been affected by storms, electromagnetic interference, etc.?	Disconnect the unit from the power supply, reconnect it after a while and switch it back on.
The sound of running water can be heard.	Has the air conditioner just been switched on or off?	It is the sound caused by the flow of refrigerant inside the unit. It is a normal phenomenon.
A crackling sound is heard.	Has the air conditioner just been switched on or off?	It is a sound caused by friction during thermal expansion or contraction of the panel or other parts when the temperature changes.
The air guide louvre does not normally close.	Has the air guide louvre been adjusted?	Disconnect the power supply for 3 seconds and then reconnect it. If the problem persists, disconnect the power supply, reinstall the air guide louvres (reinstall the upper louvre and then the lower louvre) and then reconnect the power supply.



WARNING

- If the following conditions occur, switch off the air conditioner immediately and disconnect the power supply. Then ask your dealer or authorized service for repair.
 - The power cord is overheating or damaged.
 - Abnormal noise during operation.
 - Circuit breaker trips frequently.
 - The air conditioner smells like something is burning.
 - Refrigerant is leaking from the indoor unit.
- Do not repair and/or modify the air conditioner yourself.
- If the air conditioner operates under abnormal conditions, it may cause malfunction, electric shock and/or fire.

Explanation of symbols

WARNING

This symbol indicates the possibility of death or serious injury.

CAUTION

This symbol indicates the possibility of injury or damage to property.

NOTICE

Indicates important information. Failure to observe it may result in damage to property.

Disclaimer

The manufacturer shall bear no liability for any injury and/or property loss caused by the following:

1. Damage to the product due to its misuse or mishandling.
2. Modification, alteration and/or maintenance of the product and/or its use with other equipment contrary to the manufacturer's instructions.
3. Upon verification that the product defect is directly caused by corrosive gas.
4. Upon verification that the defect is caused by improper handling during transportation of the product.
5. Operation, repair and/or maintenance of the unit without following the operating instructions and/or relevant regulations.
6. Upon verification that the problem and/or dispute is caused by the quality and/or performance of components and/or parts manufactured by other manufacturers.
7. Damage is caused by natural disasters, improper operating environment and/or force majeure.





If installation, relocation and/or repair of the air conditioner is required, please contact your dealer or local service centre first. An air conditioner must only be installed, relocated and/or repaired by an authorized company. Otherwise, serious damage, personal injury or death may occur.

If refrigerant leaks and/or needs to be extracted during installation, maintenance and/or disassembly of the equipment, contact a suitably qualified professional or take other appropriate action in accordance with local codes and regulations.

This equipment should not be operated by persons (including children) with impaired physical, sensory and/or mental abilities and/or lack of the necessary knowledge and/or experience unless they are supervised and/or instructed about the operation of the equipment by a person responsible for their safety.

Children should be supervised so that they do not play with the equipment.

Refrigerant

 <p>The equipment is filled with flammable refrigerant R32.</p>	 <p>Read the installation instructions first before installation.</p>
 <p>Read the operating instructions first before use.</p>	 <p>Read the service manual first before repairing.</p>

- To ensure the functionality of the air conditioner, a special refrigerant is circulated in the system. The refrigerant used is R32 fluoride, which is specially purified. The refrigerant is flammable and odourless. If it leaks accidentally, it can explode under certain conditions. However, the flammability of the refrigerant is very low. It can only be ignited by fire.
- Compared to conventional refrigerants, R32 is a non-polluting refrigerant and does not damage the ozone layer. It also has a low greenhouse effect. R32 has very good thermodynamic properties. As a result, very high energy efficiency can be achieved. The equipment therefore needs a smaller refrigerant charge.

WARNING

Do not use any means other than those recommended by the manufacturer to accelerate the defrosting process and/or to clean the equipment. If repair is required, contact the nearest authorized service centre. Any repairs carried out by unqualified persons can be dangerous. The equipment should be located in a room where there is no permanent risk of ignition of flammable substances (for example, an open fire, a running gas burner and/or an electric heater with hot coils). Do not puncture the refrigerant pipe and/or throw it into a fire. The equipment is to be installed, operated or stored in a room with a floor area greater than $X \text{ m}^2$. (For area size X, see table "a" in the section "Safe handling of flammable refrigerant".) The equipment is filled with flammable refrigerant R32. Follow the manufacturer's instructions exactly when carrying out repairs. Keep in mind that the refrigerant may not give off any odour. Read the specialist instructions.



- This equipment should not be operated by persons (including children) with impaired physical, sensory and/or mental abilities and/or lack of the necessary knowledge and/or experience unless they are supervised and/or instructed about the operation of the equipment by a person responsible for their safety. Children should be supervised so that they do not play with the equipment.

- 1) The WiFi module operates in the 2400-2483.5 MHz frequency band.
- 2) The maximum transmission power in this band is 20 dBm.



R32: GWP 675

This designation means that this product must not be disposed of in normal municipal waste. Please recycle it responsibly to prevent damage to the environment and

human health that may occur when the product is disposed of improperly, and to contribute to the sustainable reuse of natural resources.

To dispose of used equipment, use the appropriate waste collection service or contact the dealer from whom the product was purchased. They can take the product and recycle it in an environmentally friendly way.

If installation, relocation and/or repair of the air conditioner is required, please contact your dealer or local service centre first. An air conditioner must only be installed, relocated and/or repaired by an authorized company. Otherwise, serious damage, personal injury or death may occur.

Safe handling of flammable refrigerant

Qualification requirements for installers and maintenance workers

- All personnel working on air conditioning systems should have a valid certificate issued by an authorised organisation and a qualification for working with refrigeration systems recognised in the industry. If other technicians are required to maintain and/or repair the equipment, they should be supervised by a person qualified in the use of flammable refrigerants.
- The equipment should only be repaired in accordance with the procedure recommended by the equipment manufacturer.

Installation notes

- The air conditioner may only be installed in a room that has more than the minimum floor area. The minimum room area is indicated on the nameplate or in the following table.
- It is forbidden to drill holes in the refrigerant pipe and/or to throw it into a fire.
- After installation, a test must be carried out to ensure that no refrigerant leaks from the equipment.

Table a: Minimum room area (m²)

Refrigerant charge (kg)	Floor installation	Window installation	Wall installation	Ceiling installation
≤1.2	/	/	/	/
1.3	14.5	5.2	1.6	1.1
1.4	16.8	6.1	1.9	1.3
1.5	19.3	7	2.1	1.4
1.6	22	7.9	2.4	1.6
1.7	24.8	8.9	2.8	1.8
1.8	27.8	10	3.1	2.1
1.9	31	11.2	3.4	2.3
2	34.3	12.4	3.8	2.6
2.1	37.8	13.6	4.2	2.8
2.2	41.5	15	4.6	3.1
2.3	45.4	16.3	5	3.4
2.4	49.4	17.8	5.5	3.7
2.5	53.6	19.3	6	4

Maintenance notes

- Check that the maintenance area and room floor area meet the requirements specified on the nameplate.
 - The equipment may only be operated in rooms that meet the requirements on the nameplate.
- Check that the maintenance area is well ventilated.
 - Constant ventilation must be ensured during work.

- Check that the maintenance area is free of open fire and/or potential sources of fire.
 - There must be no open fire in the maintenance area and a “No Smoking” warning sign must be displayed.
- Check that the labels on the equipment are in good condition.
 - Replace warning signs that are not visible or are damaged.

Soldering

- If you have to cut and/or solder the pipes of the refrigerant system during maintenance, follow the steps below:
 - a) Switch off the equipment and disconnect it from the power supply.
 - b) Extract the refrigerant.
 - c) Evacuate.
 - d) Clean the tubes with nitrogen gas (N₂).
 - e) Perform cutting and/or soldering.
 - f) Put the equipment into operation.
- Refrigerant for recycling must be stored in a special container.
- Make sure that there is no open fire near the vacuum pump exhaust and that the area is well ventilated.

Refilling the refrigerant

- When filling, use equipment that is designed exclusively for R32 refrigerant. Make sure that the different types of refrigerants do not contaminate each other. When filling the refrigerant, the refrigerant container should be in an upright position.
- When filling is complete, affix a label to the equipment with the details of the refrigerant added.
- Take care not to overfill the refrigerant.
- Check for refrigerant leaks after completion of filling and before test operation. A refrigerant leak check should also be carried out when the equipment is relocated.

Safety instructions for transport and storage

- Before unloading the equipment and opening the shipping package, check with a flammable gas detector.
- There must be no open fire in the area. Do not smoke.
- Observe local regulations and laws.

Parts name

Outdoor Unit

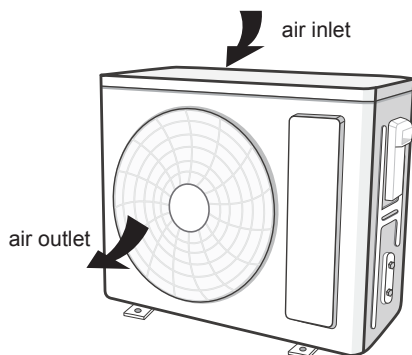

NOTE

- Actual product may be different from above graphics, please refer to actual product.

Installation notice

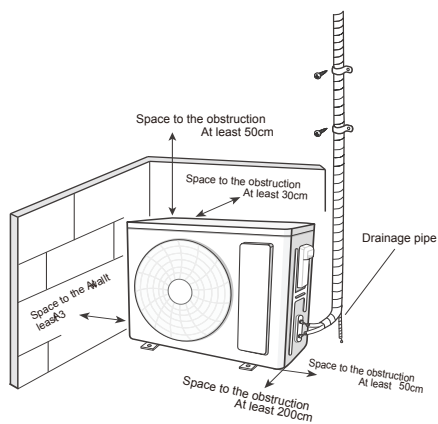

NOTE CONCERNING PROTECTION OF ENVIRONMENT



This product must not be disposed of via normal household waste after its service life, but must be taken to a collection station for the recycling of electrical and electronic devices. The symbol on the product, the operating instructions or the packaging indicate such disposal procedures. The materials are recyclable in accordance with their respective symbols. By means of re-use, material recycling or any other form of recycling old appliances you are making an important contribution to the protection of our environment. Please ask your local council where your nearest disposal station is located.

INFORMATION CONCERNING USED REFRIGERANT MEDIUM

This unit is containing fluorinated gases included in the Kyoto protocol. The maintenance and the liquidation must be carried out by qualified personnel.

Type of refrigerant: R32

The quantity of the refrigerant: Please see the unit label.

The value GWP: 675 (1 kg R32 = 0,675 t CO₂ eq)

GWP = Global Warming Potential



Appliance filled with flammable gas R32.

In case of quality problem or other please contact your local supplier or authorized service center.

Emergency number: 112

PRODUCER

SINCLAIR CORPORATION Ltd.

16 Great Queen Street

WC2B 5AH London

United Kingdom

www.sinclair-world.com

This product was manufactured in China (Made in China).

REPRESENTATIVE

SINCLAIR Global Group s.r.o.

Purkynova 45

612 00 Brno

Czech Republic

TECHNICAL SUPPORT

SINCLAIR Global Group s.r.o.

Purkynova 45

612 00 Brno

Czech Republic

Tel.: +420 800 100 285 | Fax: +420 541 590 124

www.sinclair-solutions.com | info@sinclair-solutions.com



