

## Types of Protection Available

### • Pillow Blocks

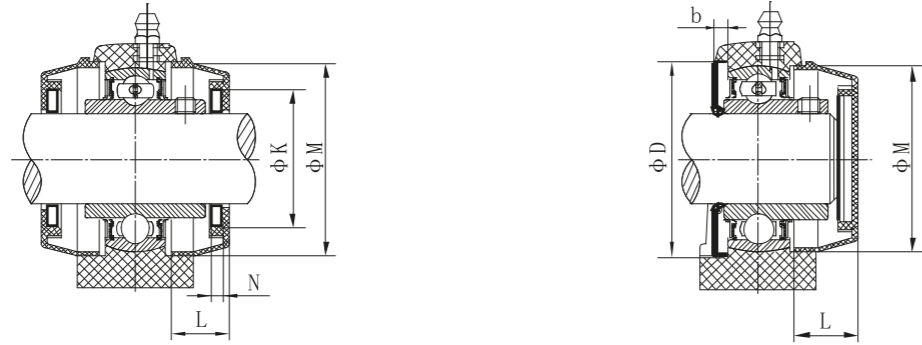

### • Flange Units

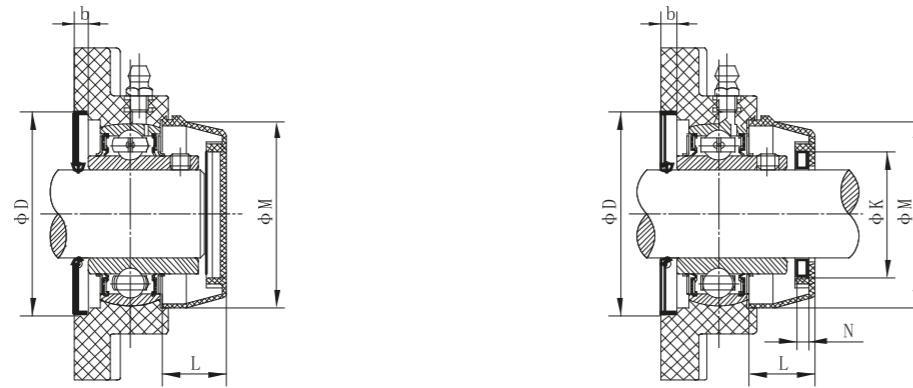

### Plastic Covers (Open/Close)

| Shaft Dia. |                           | Dimensions(mm) |   |    |      |    |   |
|------------|---------------------------|----------------|---|----|------|----|---|
| mm         | inch                      | K              | N | L  | M    | D  | b |
| 12         | 1/2                       | 32             | 7 | 23 | 50   | 52 | 6 |
| 15         | 9/16 5/8                  | 32             | 7 | 23 | 50   | 52 | 6 |
| 17         | 11/16                     | 32             | 7 | 23 | 50   | 52 | 6 |
| 20         | 3/4 13/16                 | 32             | 7 | 23 | 50   | 52 | 6 |
| 25         | 13/16 7/8 15/16 1         | 37             | 7 | 25 | 55   | 62 | 6 |
| 30         | 1 1/16 1 1/8 1 3/16 1 1/4 | 42             | 7 | 30 | 64   | 72 | 6 |
| 35         | 1 1/4 1 5/16 1 3/8 1 7/16 | 47             | 7 | 32 | 74.5 | 82 | 6 |
| 40         | 1 1/2 1 9/16              | 52             | 7 | 37 | 84   | 88 | 6 |
| 45         | 1 5/8 1 11/16 1 3/4       | 57             | 7 | 41 | 89   | 93 | 6 |
| 50         | 1 3/4 1 7/8 1 15/16 2     | 62             | 7 | 47 | 94   | 98 | 6 |

## Static Breaking Strength of Thermoplastic Housing

### 1. UCPPL

Mode of load

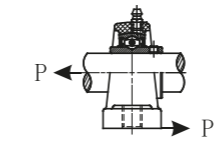
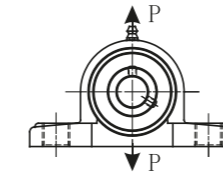
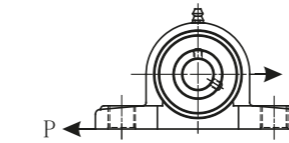

Notes : Data for reference only.

Type

| Type | 204   | 205   | 206   | 207   | 208   | 209   | 210 |
|------|-------|-------|-------|-------|-------|-------|-----|
| 8800 | 13700 | 12650 | 12750 | 13100 | 13360 | 13850 |     |
| 7700 | 10000 | 10600 | 10800 | 11100 | 11400 | 11750 |     |
| 5000 | 8100  | 5750  | 7500  | 8500  | 8950  | 9550  |     |

(N)

### 2. UCFPL

Mode of load

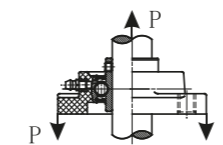
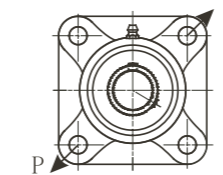
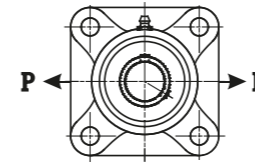

Notes : Data for reference only.

Type

| Type  | 204   | 205   | 206   | 207   | 208   | 209   | 210 |
|-------|-------|-------|-------|-------|-------|-------|-----|
| 15950 | 13000 | 18000 | 18500 | 19100 | 19350 | 19650 |     |
| 10250 | 12150 | 17700 | 18500 | 19250 | 19350 | 19620 |     |
| 3650  | 3350  | 3350  | 3520  | 3790  | 3850  | 3990  |     |

(N)