

stigwize

Stigwize 5G MiMo Outdoor Antenna



Product Stigwize 5G MiMo Outdoor Antenna

SKU STI-5G-MIMO-SMA-5M

EAN 8785285640838

Capestone articlenumber STI10003



Stigwize 5G MiMo Outdoor Antenna

Upgrade the performance of your 5G network with the Stigwize 5G MiMo antenna, the best 5G antenna and a powerhouse in mobile data connectivity designed to meet the demands of enterprises looking for reliable and efficient network solutions.

Features

- Type: OMNI MIMO Directional
- 3G: Frequency & Gain 700-960MHz 3dBi
- 4G LTE: Frequency & Gain 1700-2700MHz 7dBi
- 5G NR: Frequency & Gain 3300-3800MHz 6dBi
- Kabels: 2x 5 meter CLF200 Low Loss
- Connector: SMA
- Voltage: Standing Wave Ratio ≤ 3.2
- Power: 100 W
- Dimensions: HxWxD (cm) High 44 x Wide 7,4 x Depth 7,4 cm

Key features

- **MiMo technology:** The Stigwize 5G MiMo antenna harnesses the power of dual Multiple-Input, Multiple-Output (MiMo) technology to maximize signal strength and data throughput, ensuring exceptional network performance.
- **High-Gain Design:** With its high-gain antenna design, this device significantly expands the coverage area of your 5G network, reducing dead spots and improving overall connectivity.
- **Easy installation:** The Stigwize 4G MiMo antenna comes with mounting hardware for quick installation. Designed with simplicity in mind, this 4G MiMo antenna can be installed effortlessly, allowing for quick integration into your existing network infrastructure.
- **Weatherproof construction:** this 5G outdoor antenna is made of sturdy materials and built to withstand harsh environmental conditions, ensuring long-term reliability.

This 5G antenna can be widely used both indoors and outdoors as a 5G outdoor antenna. You can also deploy this 5G antenna as a combination of a 5G router with external antenna to provide a total solution.

Applications

- **Retail:** Stores can deploy 5G antennas to ensure that their POS systems remain connected even during network outages, enabling uninterrupted sales transactions. Major retailers such as CEWE are also deploying 5G routers and 5G antennas to connect their IoT devices and printers to a reliable 5G mobile data connection.
- **5G for outdoor areas:** the Stigwize 5G MiMo outdoor antenna is ideal for providing high-speed 5G Internet access in rural areas where traditional broadband options may be limited. The Stigwize 5G MiMo antenna can capture 5G signals from nearby transmission towers and deliver reliable Internet connectivity to homes and businesses in remote locations.
- **Construction sites:** Construction sites often lack reliable network connectivity. The Stigwize 5G MiMo outdoor antenna can be installed on construction sites to ensure project managers, engineers and workers have consistent access to communication and project management tools, improving efficiency and safety.
- **Surveillance systems:** Security and surveillance systems in remote or outdoor locations can benefit from the Stigwize 5G MiMo outdoor antenna. It provides a stable Internet connection for IP cameras and surveillance equipment, allowing real-time video streaming and remote access to surveillance feeds.
- This external antenna from Stigwize is also available in a 4G and 5G version, both with 5x meter cable and 10 meter cable.



About Stigwize

Stigwize is an antenna brand for 4G, 5G, WiFi and GPS antennas for the business market. Stigwize antennas can be used in all kinds of vertical sectors including IoT, Enterprise, Retail, Construction, Mobility, Security and Maritime.

As the European distributor of Stigwize, Capestone supplies the complete antenna portfolio. This portfolio includes 4G and 5G antennas for indoors and outdoors, vandal-resistant puck antennas and screw antennas for mounting on 5G routers.

When stigmatizing profits, in addition to favorable pricing, there are also various other benefits including a 24-month warranty and a direct SWAP policy. Capestone's engineers can also put together custom antennas for projects, so that you always have the most suitable solution, as you have come to expect from Capestone.

Specification STI-5G-MIMO-SMA-5M	
Model No.	STI-5G-MIMO-SMA-5M
Frequency	700-960MHz /1700-2700MHz /3300-3800MHz
Gain[dBi]	700-960MHz 3dBi/1700-2700MHz 6dBi/3300-3800MHz 6dBi
Antenna Type	OMNI
Polarization	Vertical
Beam width deg.	Horz.360° Vert.60°
V.S.W.R.	<=3.2
Temperature	-30°C ~ +70°C
Antenna Connector	SMA MALE x2
Antenna Cable	CLF200 Length=5M x2
Dimensions	L515×W118XH96 mm
Mounting	U-bolts
Wind load	120Km/h

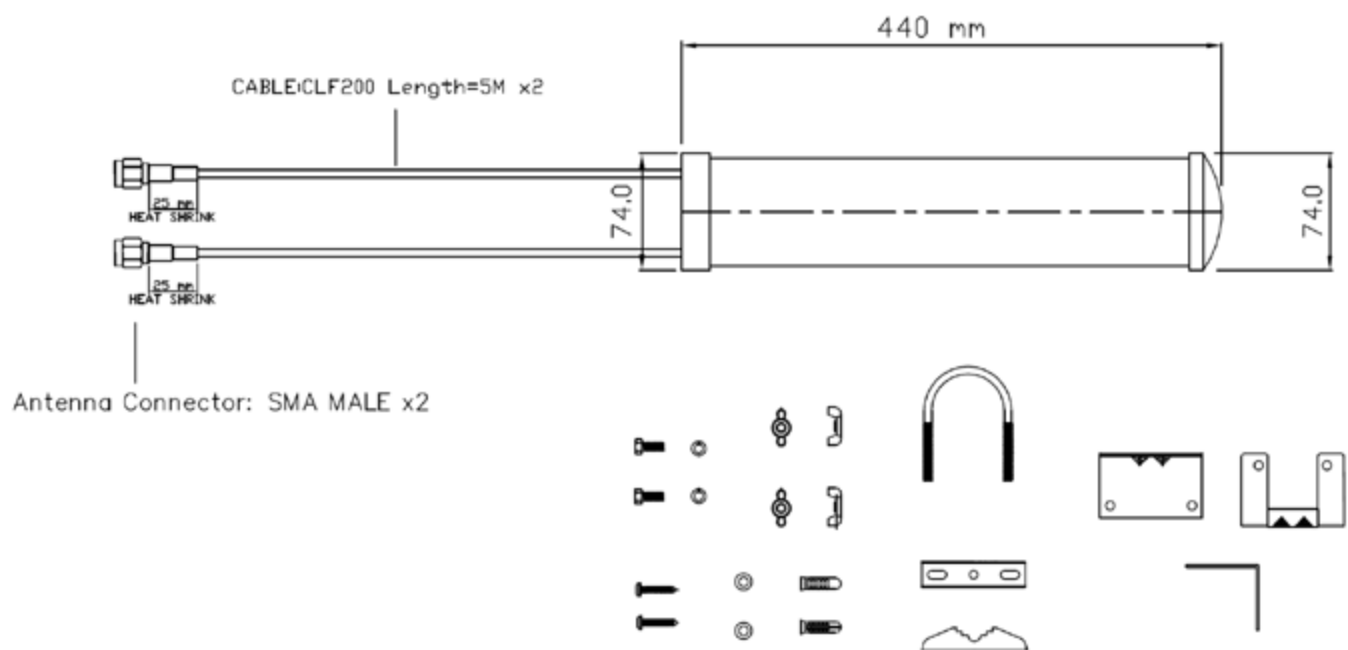

1	FREQUENCY RANGE : 700-960MHz/1700-2700/3300-3800MHz	7	LENGTH : L440xW74xH74 mm
2	GAIN : 700-960MHz 3dBi/1700-2700MHz 6dBi/3300-3800MHz 6dBi	8	Antenna Cable : CLF200 L=5M x2
3	TYPE : OMNI	9	Antenna Connector : SMA MALE x2
4	POWER HANDLING : 100W	10	
5	POLARIZATION : LINEAR VERTICAL	11	
6	VSWR : <=3.2	12	

ANTENNA 1

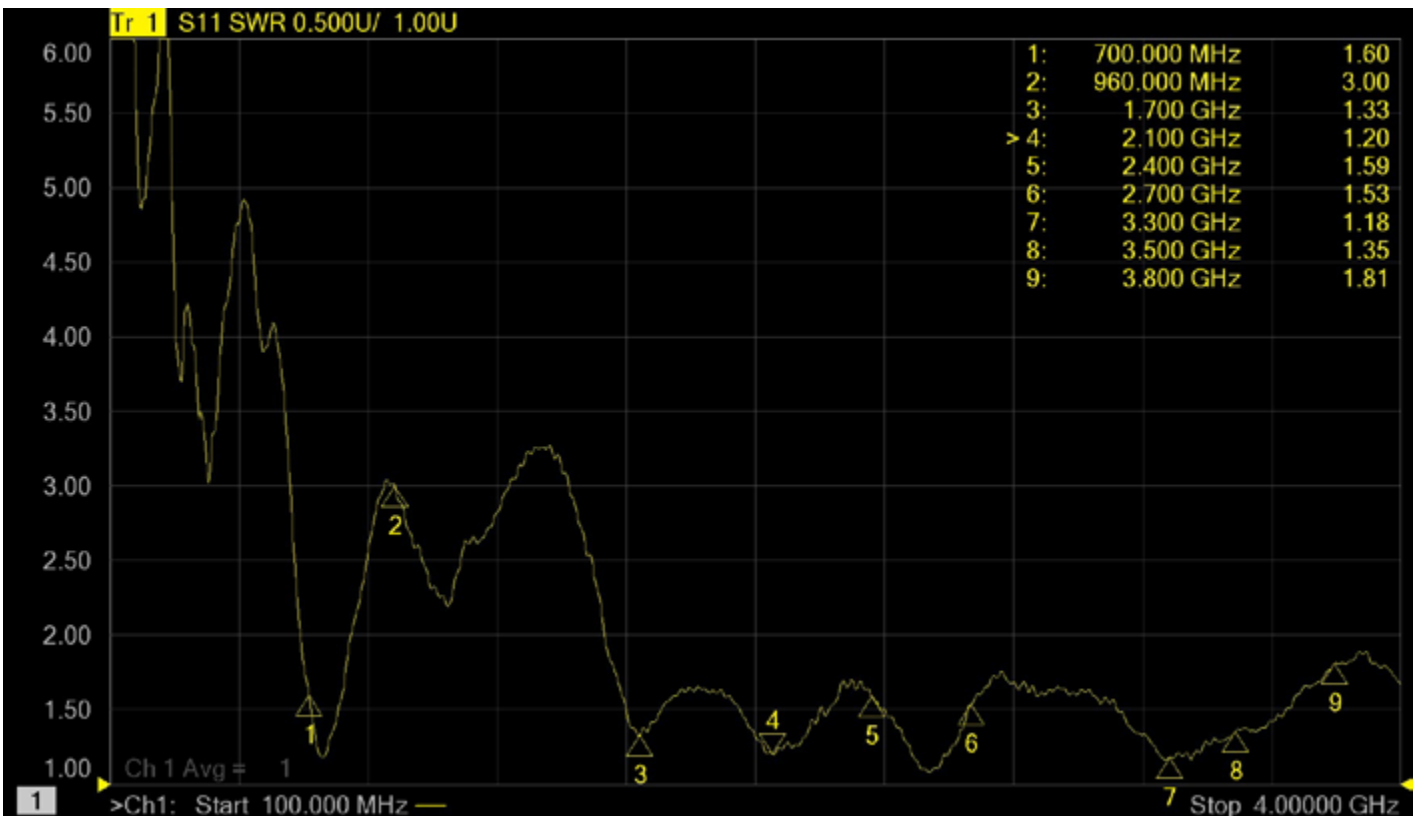
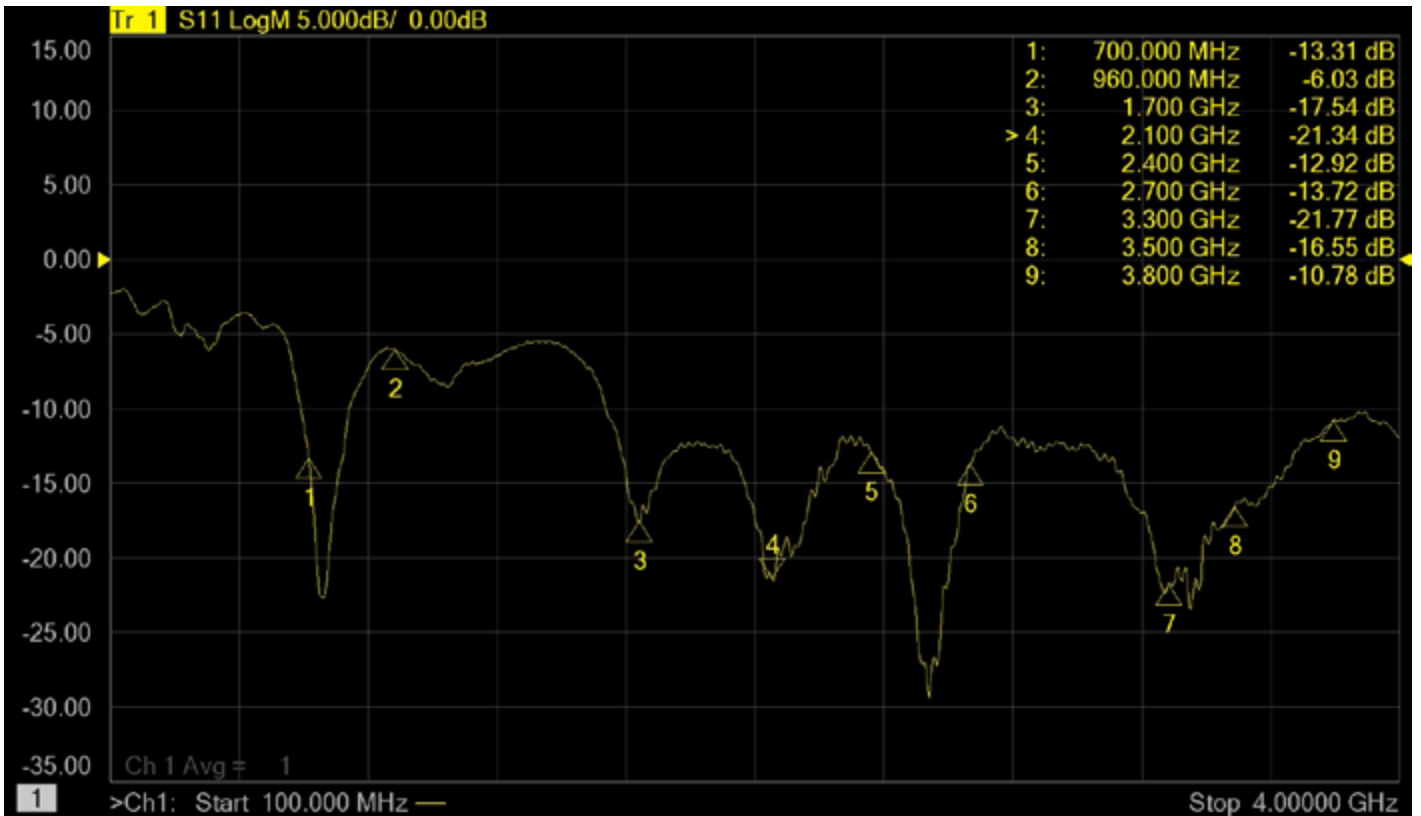

Radiation pattern :

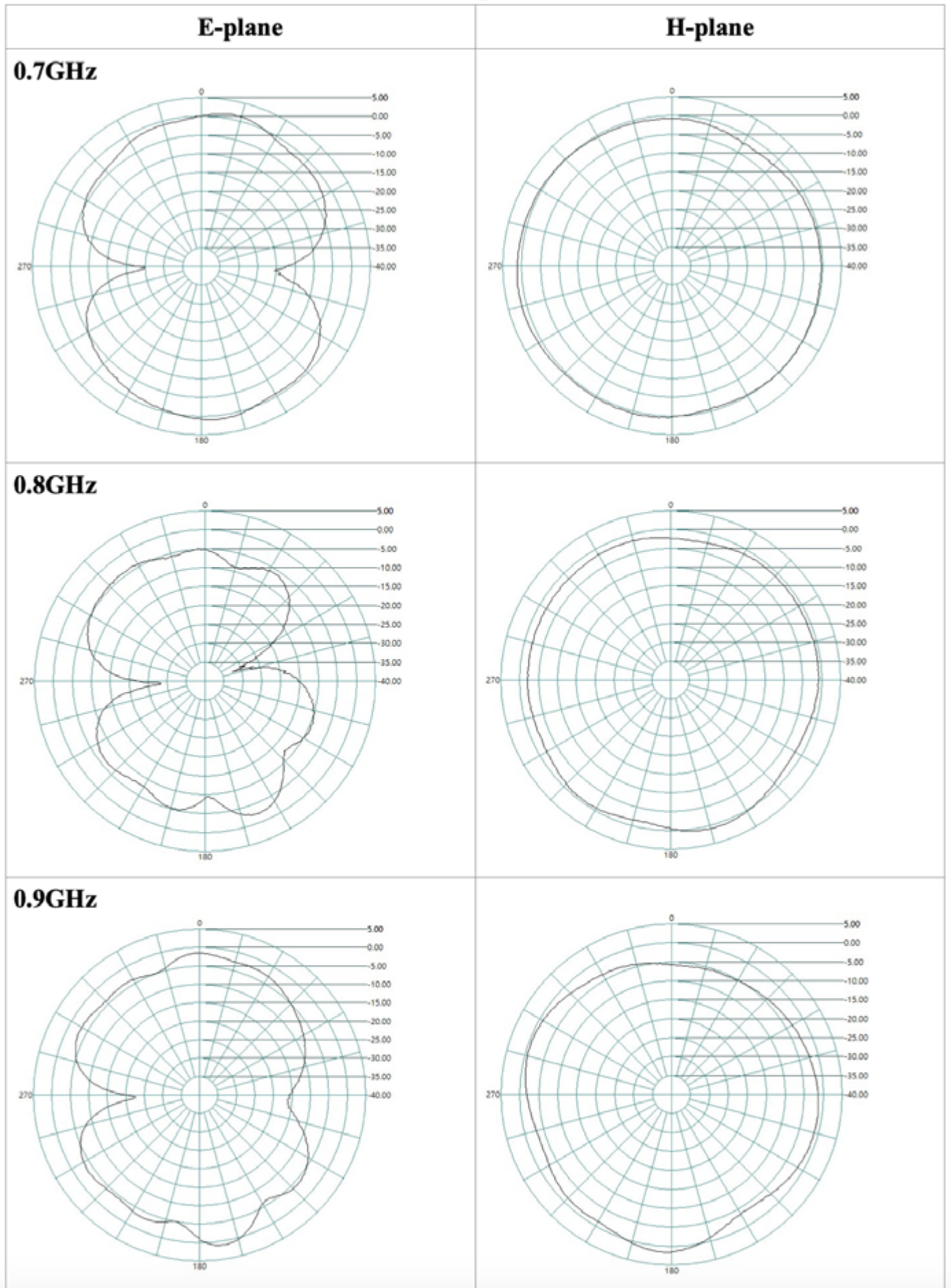

1.7GHz

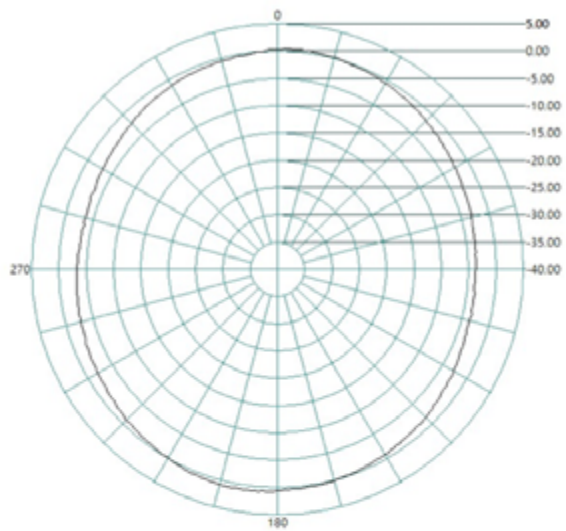
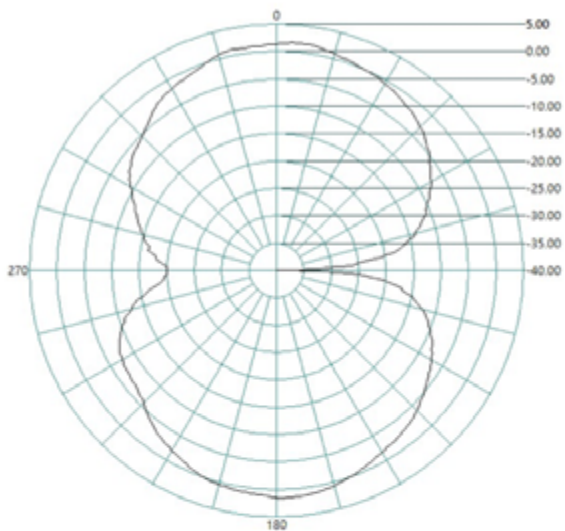

1.9GHz

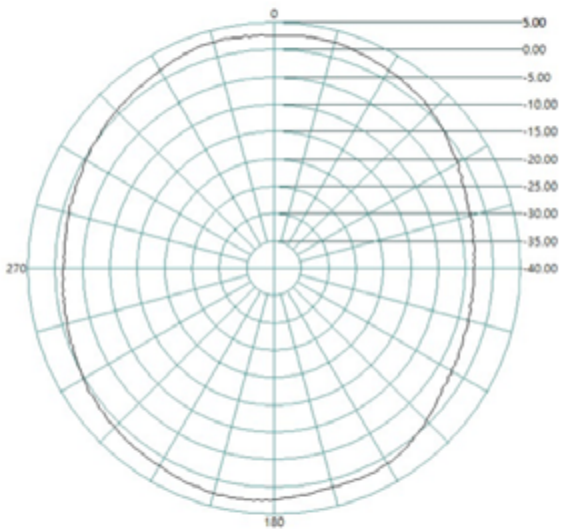
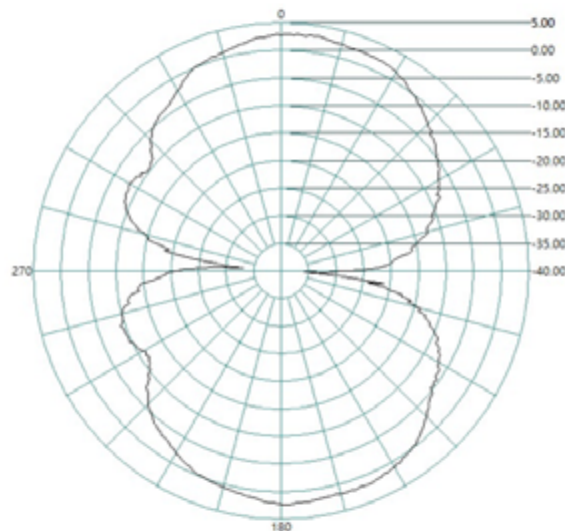

2.1GHz

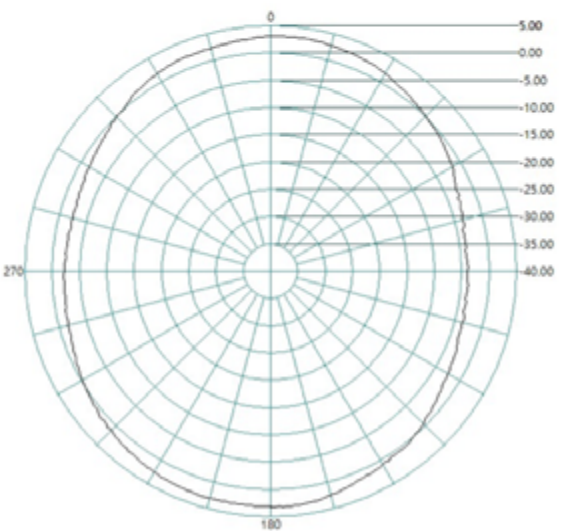
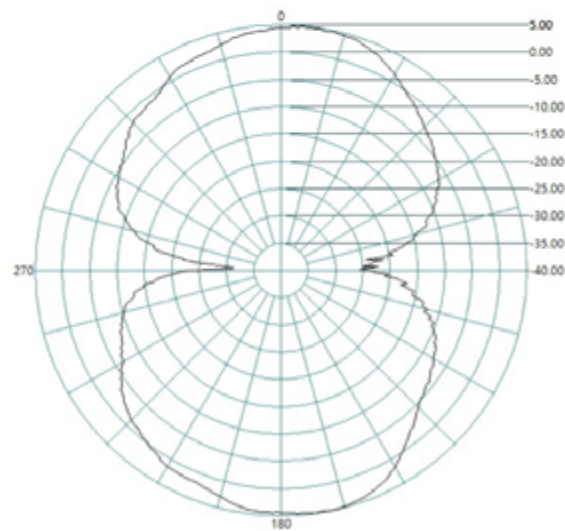

2.4GHz

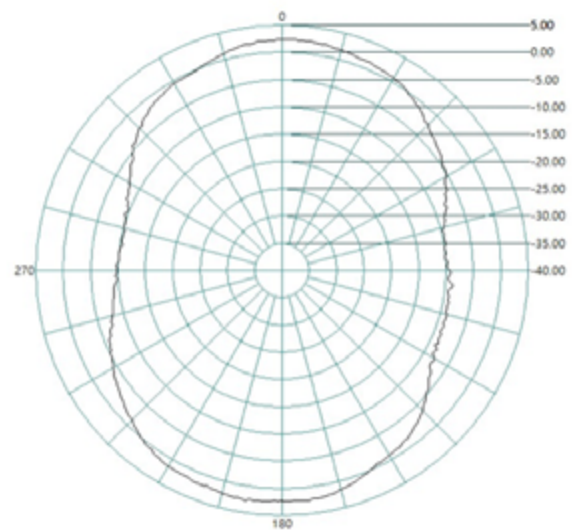
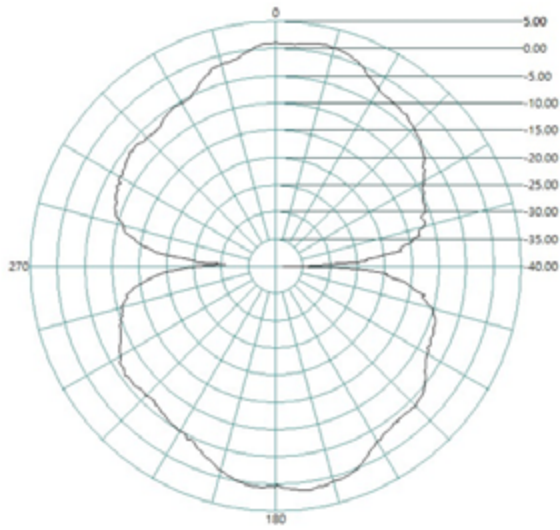

2.7GHz

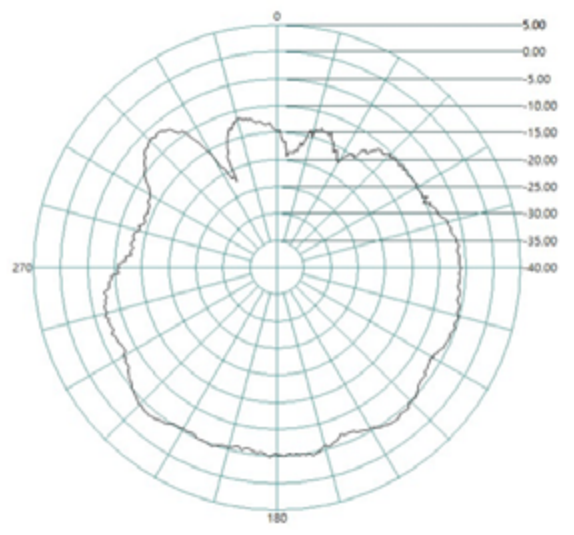
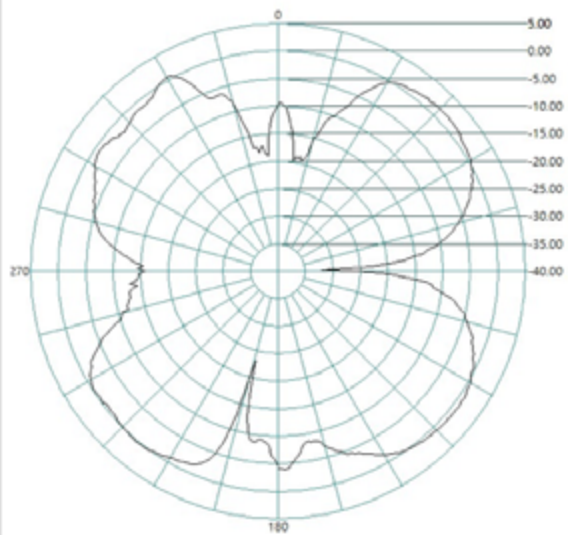

3.3GHz

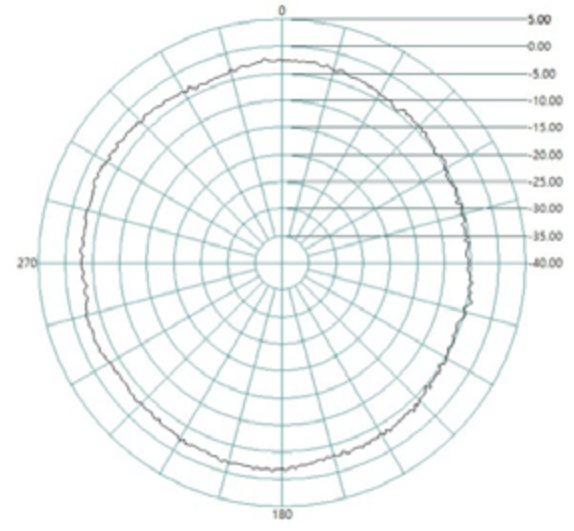
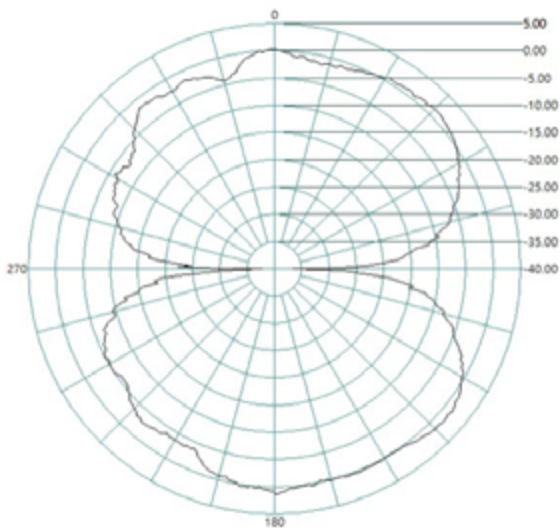

3.5GHz

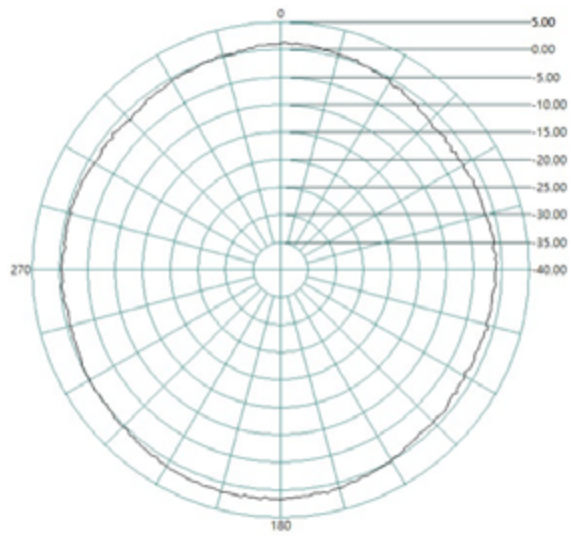
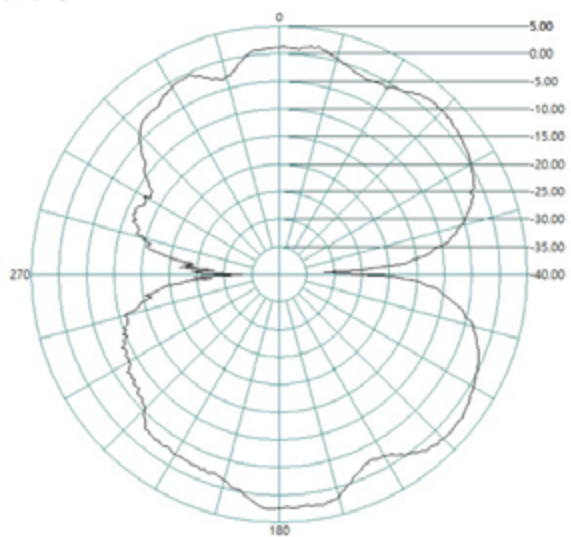

3.8GHz

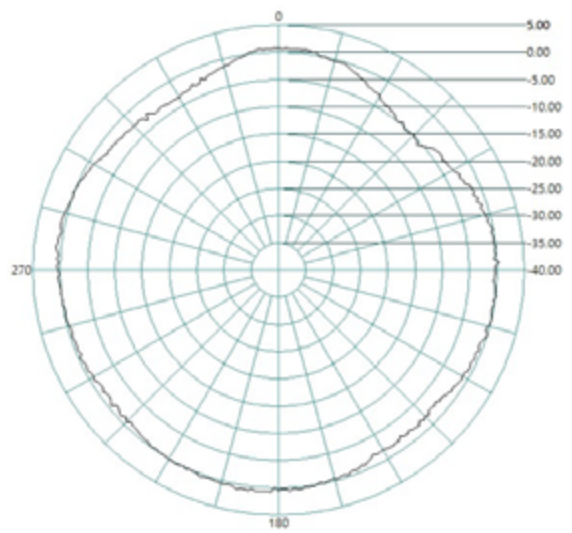
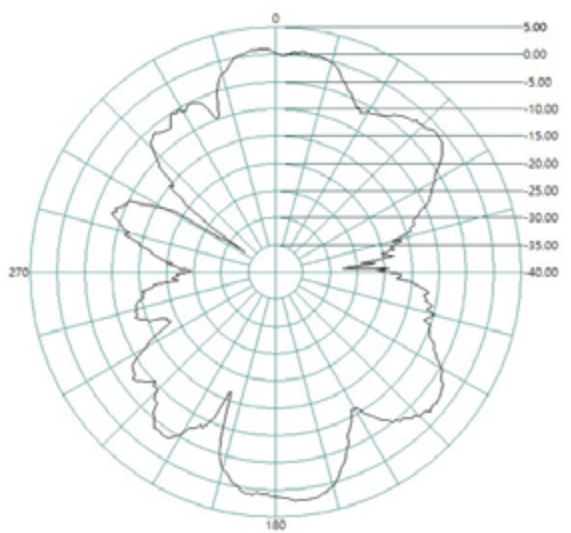

ANTENNA 2

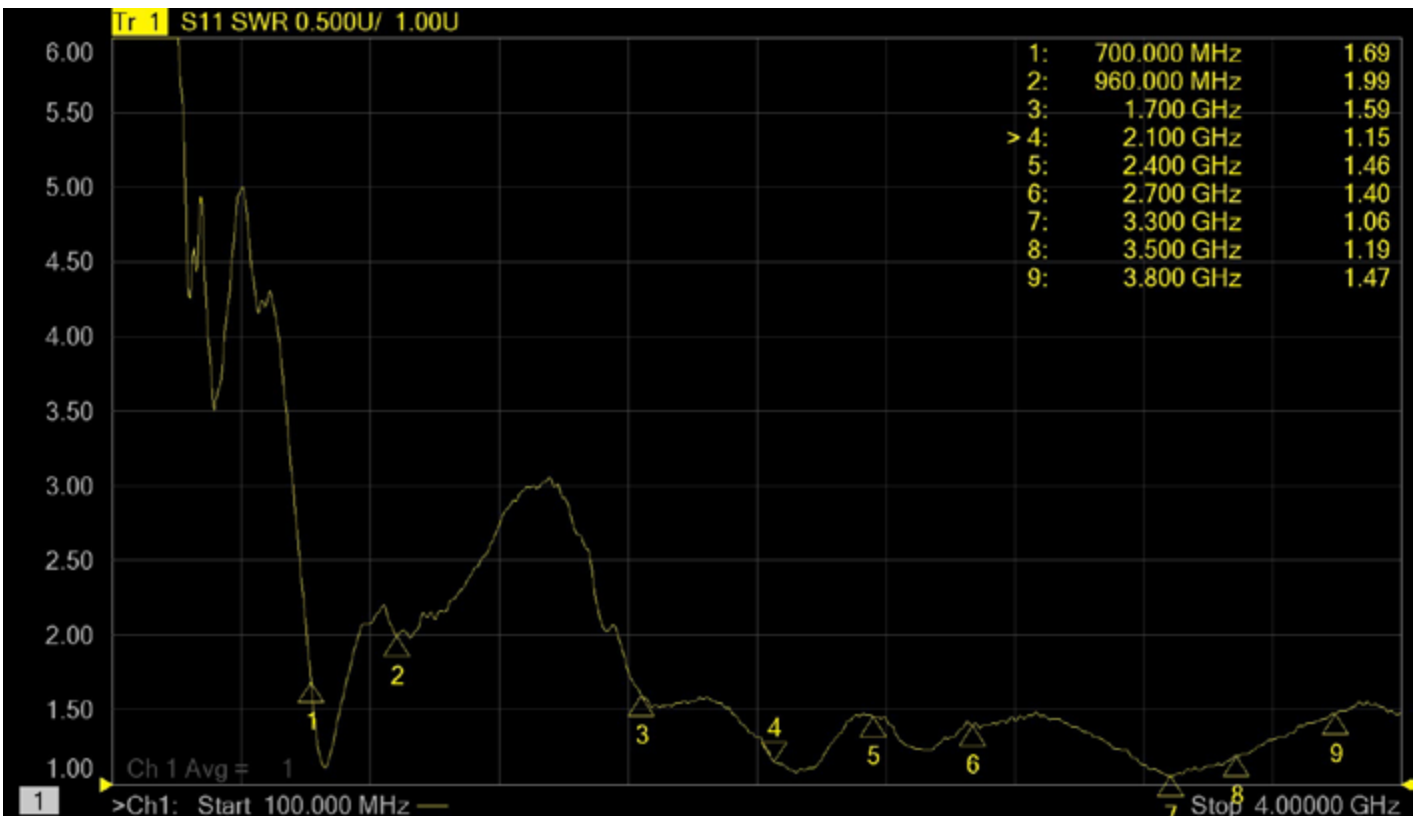
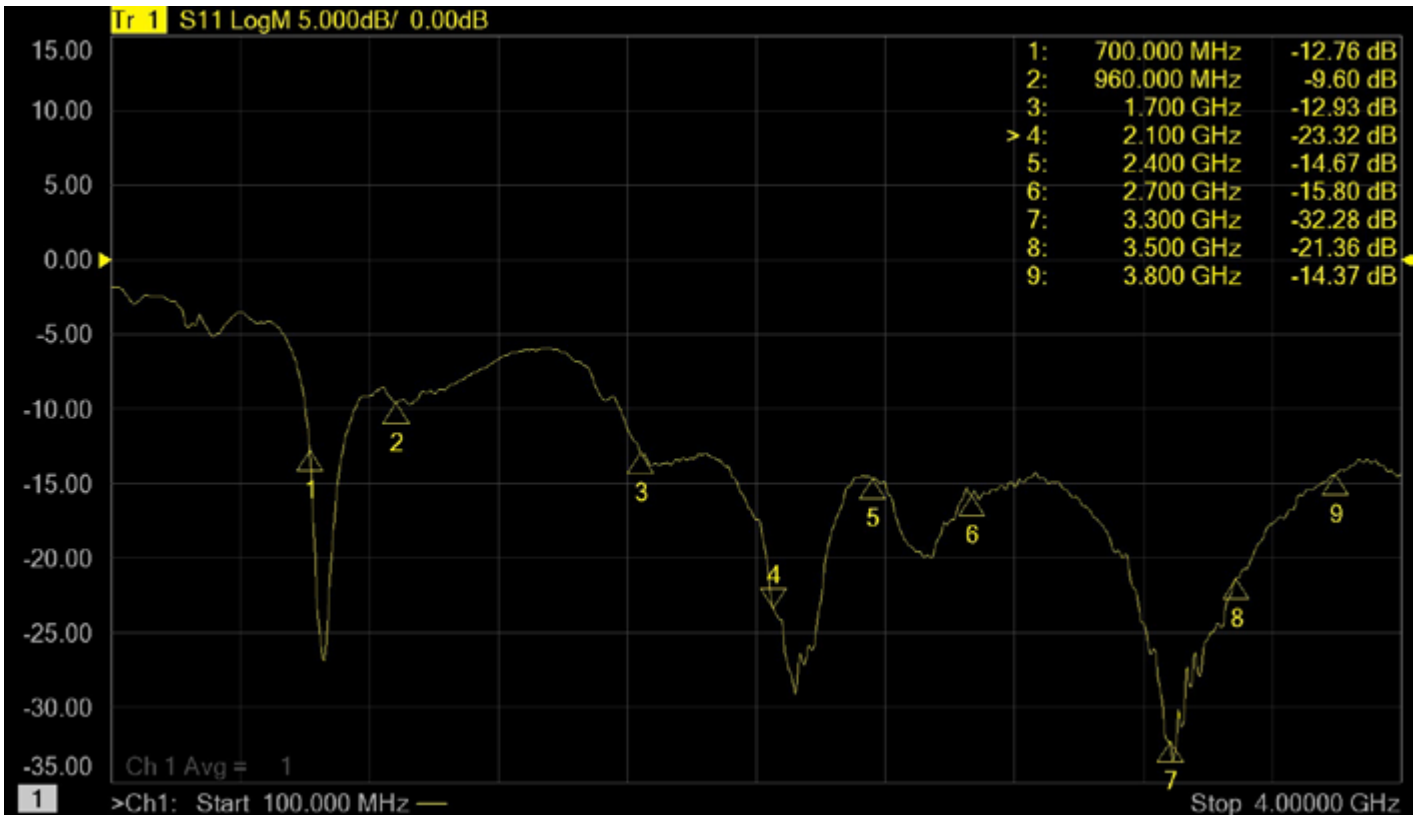

Radiation pattern :

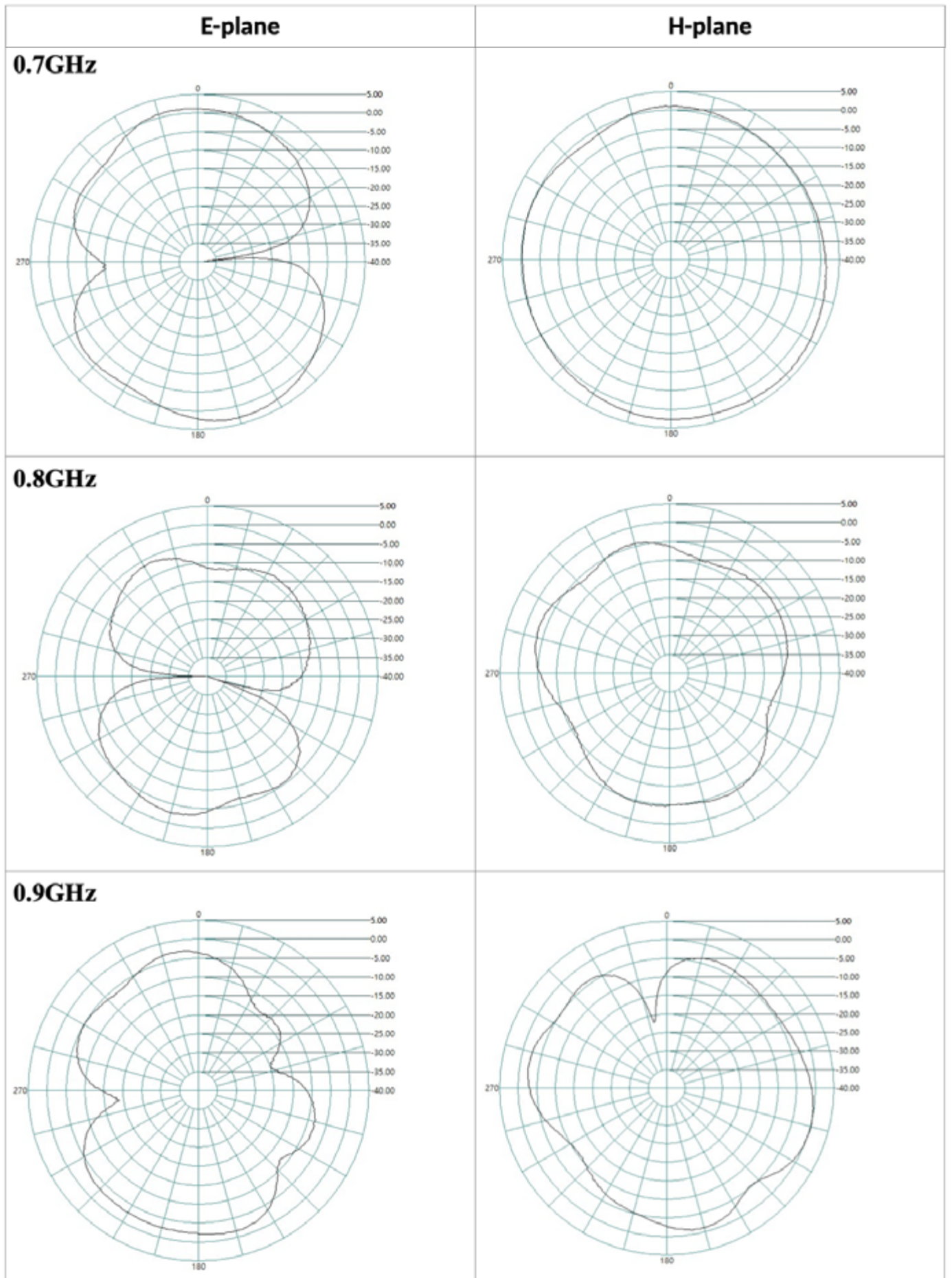

1.7GHz

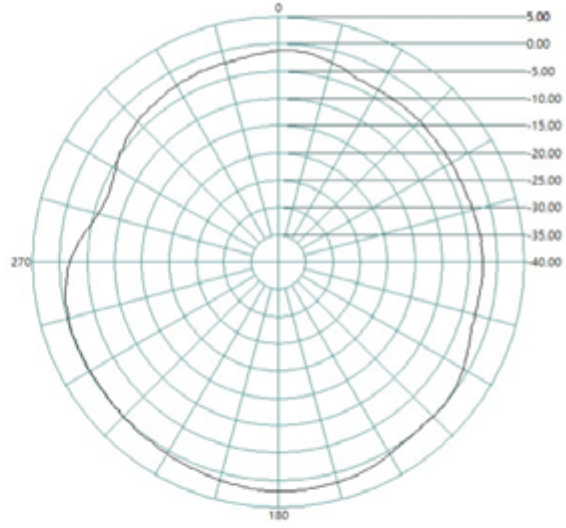
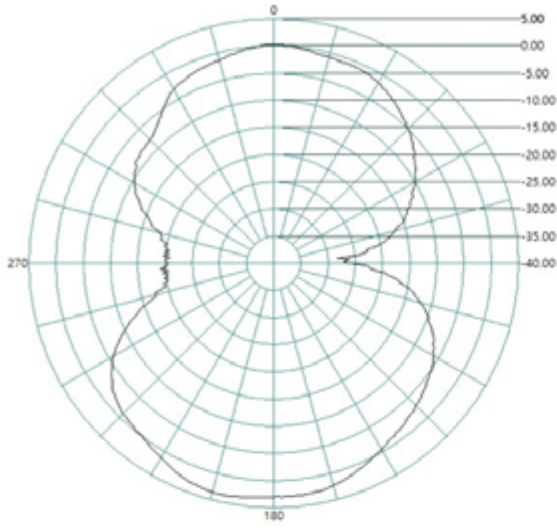

1.9GHz

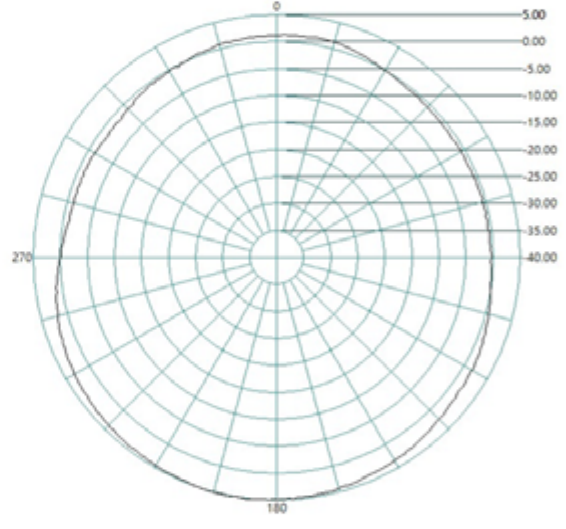
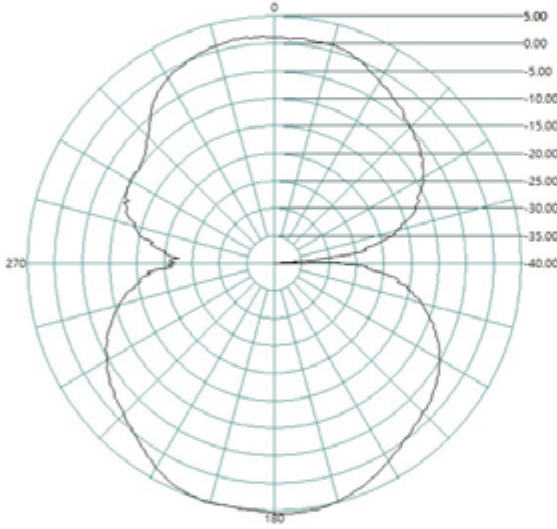

2.1GHz

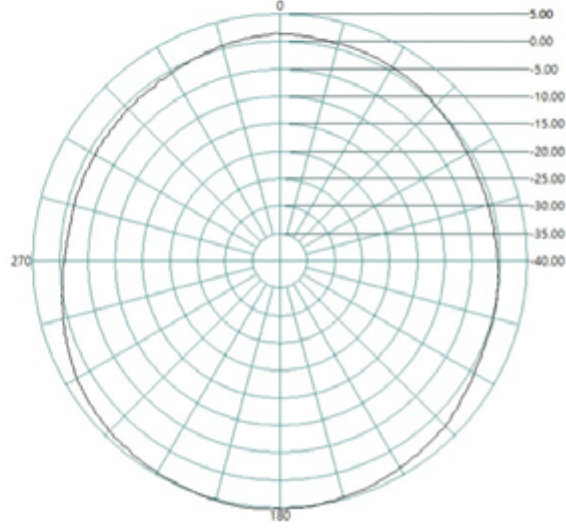
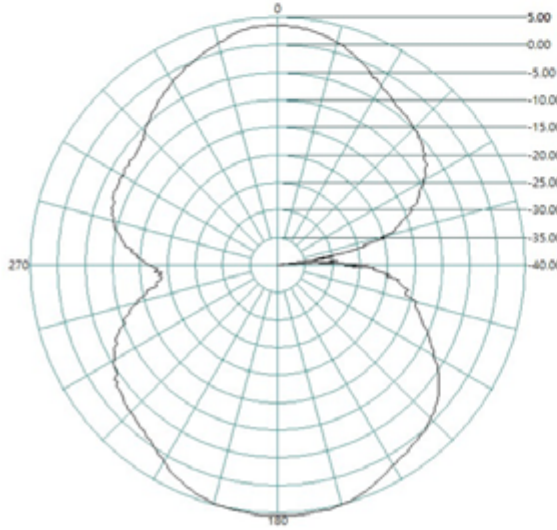

2.4GHz

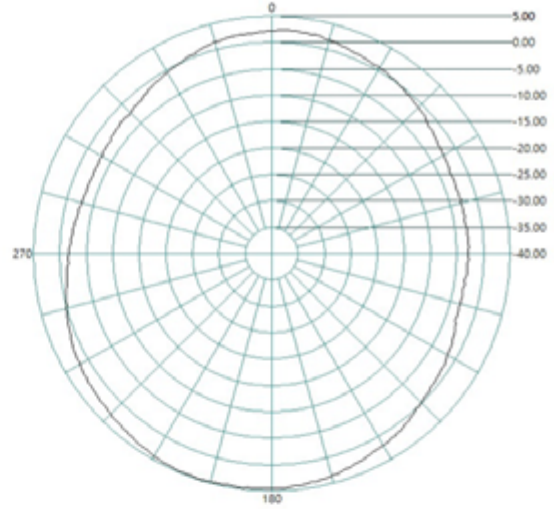
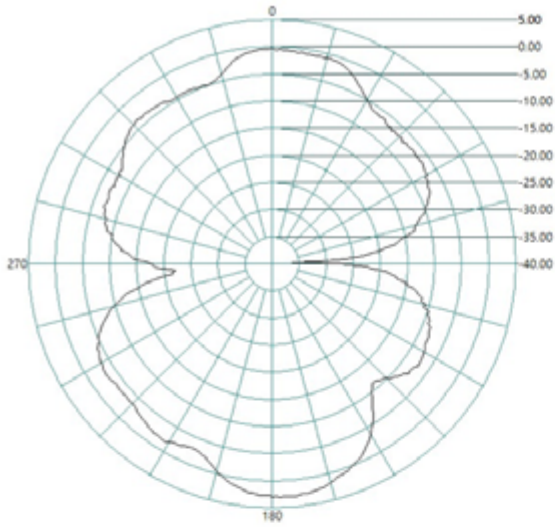

2.7GHz

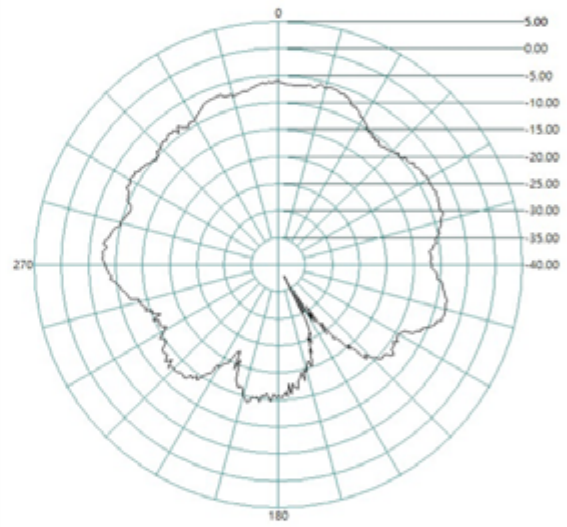
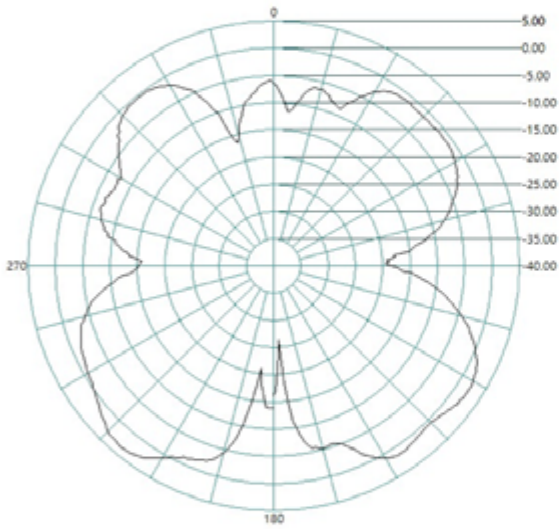

3.3GHz

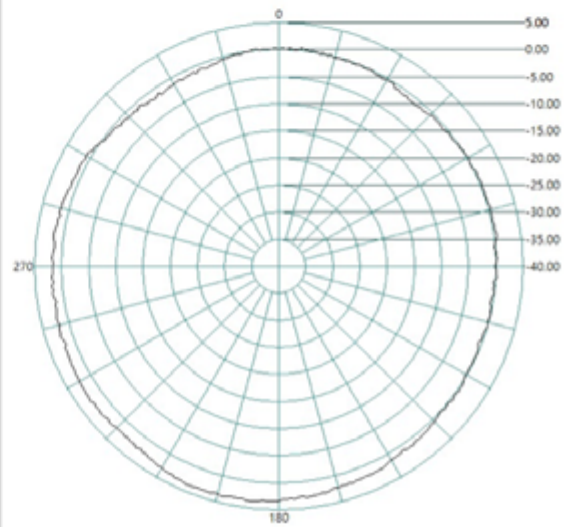
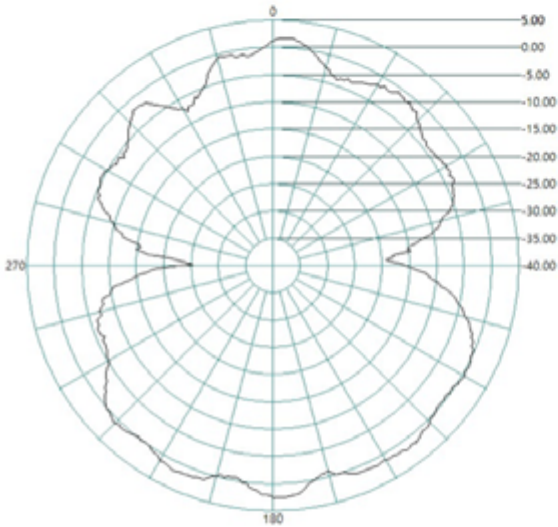

3.5GHz

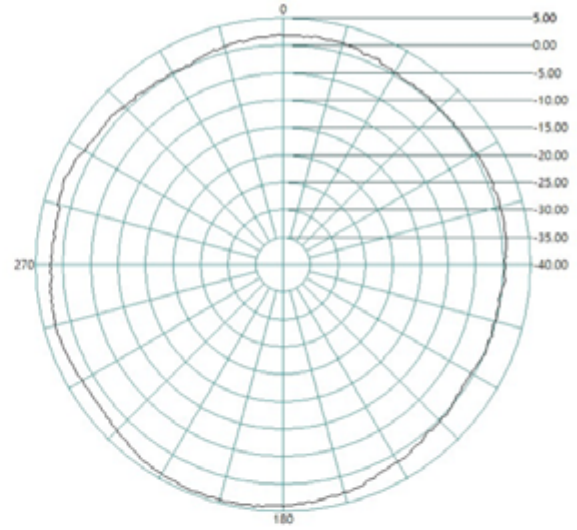
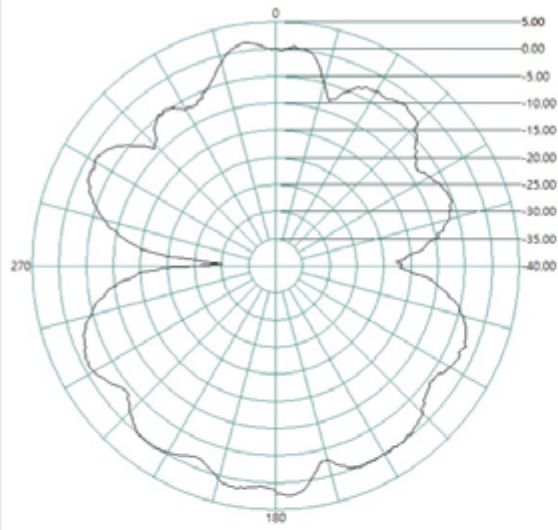

3.8GHz

