

stigwize

Stigwize 2-in-1 Puck Antenna 1x 4G | 1x GPS

Product Stigwize 2-in-1 Puck Antenna

SKU STI-PUCK-4G-GPS

EAN 8785285643341

Capestone articlenumber STI20004

RoHS
COMPLIANT



Stigwize 2-in-1 Puck Antenna

With its unique combination of 1x 4G and 1x GPS, this antenna offers a comprehensive approach to network connectivity. The Stigwize 2-in-1 Puck antenna (4G | GPS), a versatile and economical connectivity solution designed to meet the diverse needs of businesses in the modern world.

Features

- Type: PUCK antenna
- 3G/4G Frequency & Gain: 700-960/ 1700-2700MHz Gain 1-4 dBi
- GPS Frequency: 1575MHz 28 dBi
- Cables and Connector: 2x 3 RG174 meters (SMA)
- Polarization: Linear vertical
- Voltage Standing Wave Ratio: ≤ 2.5
- Dimensions HxWxD (cm): High 8 x Wide 8 x Depth 4.5 cm

Key features

- 4G connectivity: The Stigwize 2-in-1 Puck antenna features 4G mobile data connectivity. The antenna is backwards compatible with both 3G networks.
- GPS Precision: The built-in GPS antenna provides accurate location data, making it ideal for applications that require accurate geolocation information.
- Compact design: The compact and robust design of the Stigwize 2-in-1 Puck antenna makes it suitable for both indoor and outdoor installations, ensuring deployment flexibility.
- Reliable performance: Stigwize products are known for their reliability, minimizing downtime and maximizing operational efficiency.

Applications

- **Fleet Management Systems:** Companies operating a fleet of vehicles can take advantage of this antenna's GPS functionality to track the real-time location of their assets. The combination of 4G and GPS provides continuous connectivity for data transfer and communication with the vehicles, enabling efficient fleet management.
- **Industrial IoT applications:** In industrial environments, where connectivity is essential for monitoring and controlling machinery and equipment, the Stigwize 2-in-1 Puck antenna can provide both 4G mobile and GPS connectivity. This makes it suitable for applications such as remote equipment monitoring, predictive maintenance and device tracking and location.
- **Public transportation systems:** Public transportation services, such as buses and trains, can use this antenna for such things as passenger information system for passengers and real-time tracking using GPS. 4G connectivity allows passengers to stay connected throughout their journey, while GPS enables accurate tracking and planning.
- **Outdoor surveillance and security:** Outdoor surveillance cameras and security systems often require remote connectivity. The rugged design of this antenna, combined with its 4G and GPS capabilities, can support surveillance cameras in remote locations. GPS functionality can help geotag incidents and asset tracking.
- **Agricultural automation:** In precision agriculture, farmers can use this antenna to monitor and control agricultural equipment such as drones and autonomous vehicles. The 4G connections enable data exchange for crop monitoring and equipment management, while GPS provides accurate maps and navigation for farm machinery. These usage scenarios highlight the versatility of the Stigwize 2-in-1 Puck antenna, making it an essential tool for various industries and applications that require reliable and versatile connectivity solutions.



About Stigwize

Stigwize is an antenna brand for 4G, 5G, WiFi and GPS antennas for the business market. Stigwize antennas can be used in all kinds of vertical sectors including IoT, Enterprise, Retail, Construction, Mobility, Security and Maritime.

As the European distributor of Stigwize, Capestone supplies the complete antenna portfolio. This portfolio includes 4G and 5G antennas for indoors and outdoors, vandal-resistant puck antennas and screw antennas for mounting on 5G routers.

When stigmatizing profits, in addition to favorable pricing, there are also various other benefits including a 24-month warranty and a direct SWAP policy. Capestone's engineers can also put together custom antennas for projects, so that you always have the most suitable solution, as you have come to expect from Capestone.

Specification STI-PUCK-4G-GPS	
Model No.	STI-PUCK-4G-GPS
Antenna Type	Roof Screw Mount
Antenna Size	L80xW80xH45 mm
LTE	
Gain (dBi)	1-4 dBi
Frequency	700-960 /1700-2700MHz
V.S.W.R.	<=2.5
Polarization	Linear Vertical
Temperature	-40 to +85 °C
Humidity	40% to 95% RH
Antenna Connector	SMA Male
Antenna Cable	RG174 Length=3M

GPS**Ceramic Path Specification**

Operating Frequency	T1 1575.42±1.023MHz
Output Impedance	50 ohms
Polarization	R.H.C.P.
Bandwidth	10 MHz min. @S11<=-10 dB
Gain at 10° elevation	-1 dBic Typ.
Axial Ratio	3.0 dB Typ.

LNA/Filter Specification

Operating Frequency	T1 1575.42±1.023 MHz
Gain	28 Db Typ.
Noise Figure	1.5 Typ.
Filter	DR Filter
	20dB 30dB min @ fo±50MHz
	30dB 35dB min @ fo±50MHz
	* fo=1575.42 MHz
Output V.S.W.R.	2.0 Max
Voltage	2.3~5.5V
Current	2.5V : 6.6mA Typical
	3V : 8.6mA Typical
	4V : 12.6mA Typical
	5V : 16.6mA Typical

General specification

Dimensions	L 41xW38xH13 mm
Antenna Color	Black
Coaxial Cable	RG174 Length=3M
Cable Connector (GPS)	SMA Male
Operating Temperature	-30°C to +85°C
Storage Temperature	-40°C to +90°C

GPS ACTIVE/LTE(700-960MHz/1700-2700MHz 1-4dBi) 2 IN 1 80mm Circle ROOF SCREW+RG174(3M)x2+SMA MALE(GPS)+SMA MALE(LTE)

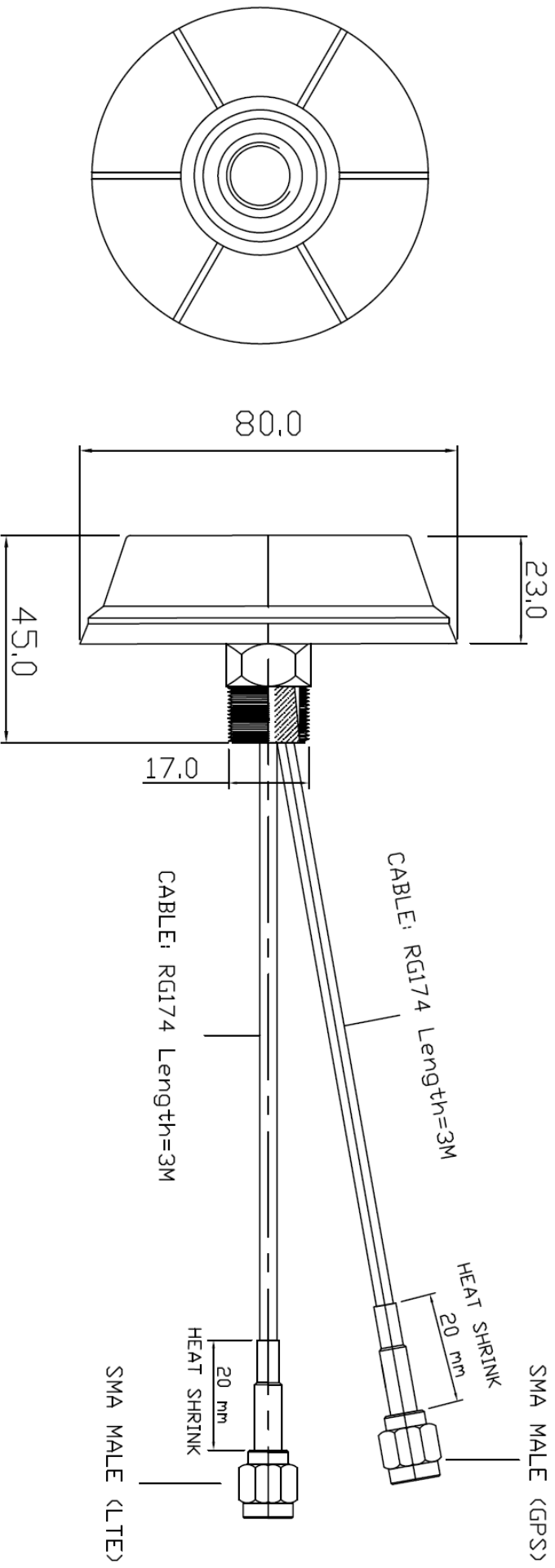

1	FREQUENCY : GPS 1575 /LTE 700-960/1575-2700MHz	6	IMPEDANCE : 50 Ω
2	GAIN : GPS 28dB/LTE 1-4dBi	7	
3	V.S.W.R : GPS <2.0 ,LTE <2.5	8	
4	CABLE LENGTH : RG174 L=3M x2	9	
5	CONNECTOR : SMA MALE(GPS) / SMA MALE (LTE)	10	

GPS Port

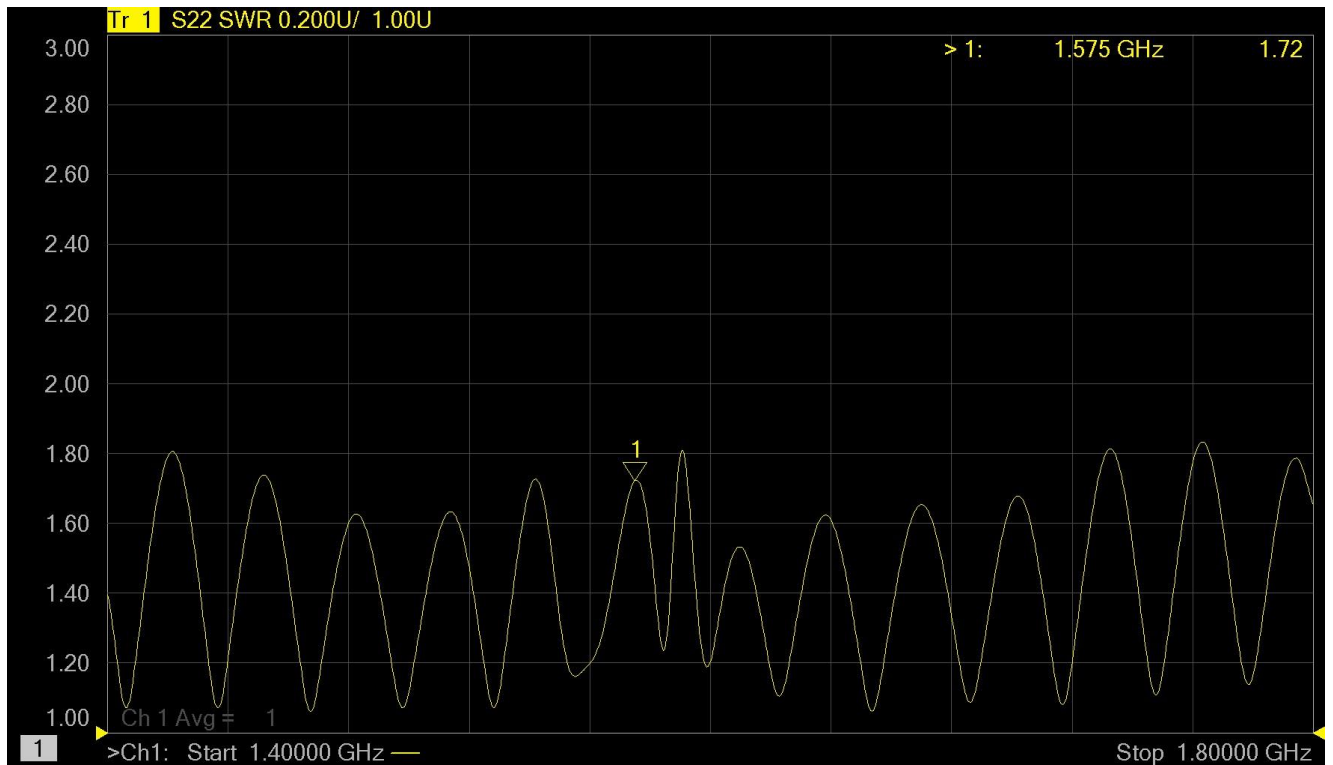
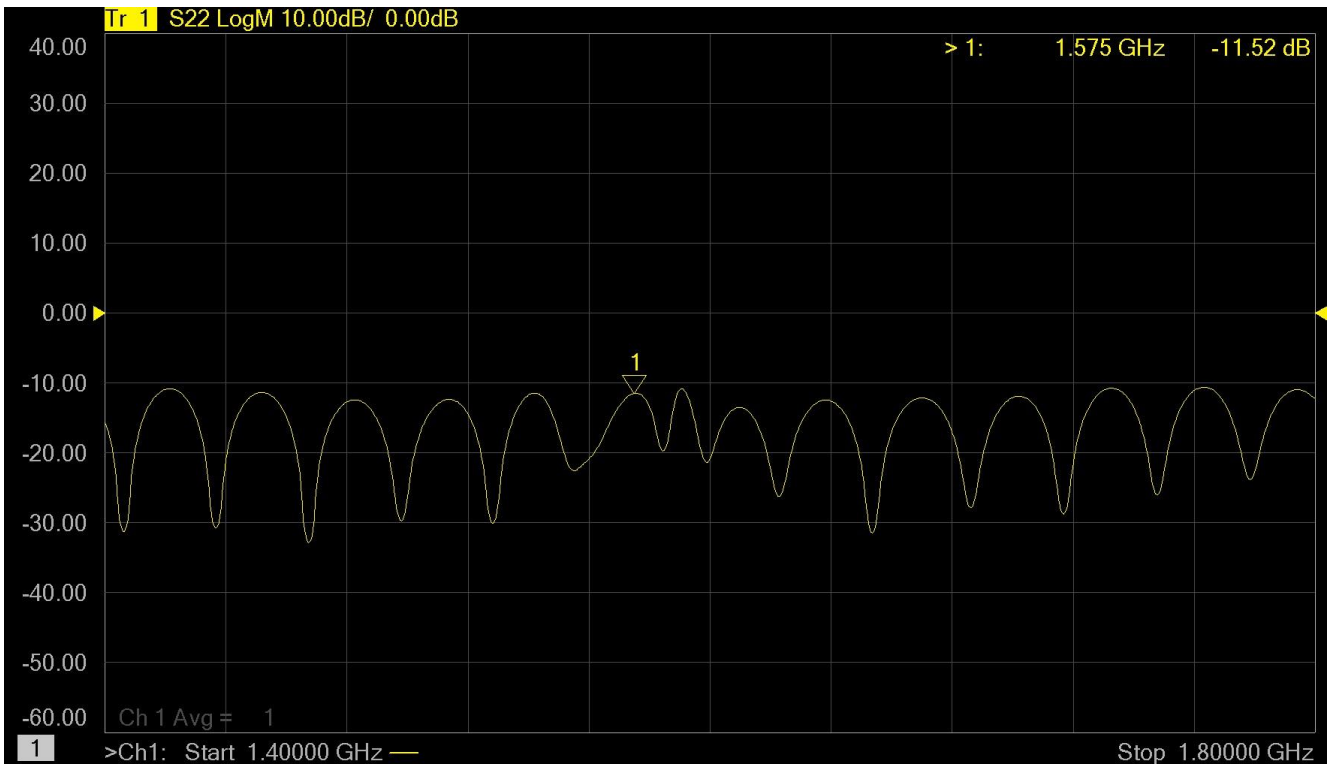

Radiation pattern

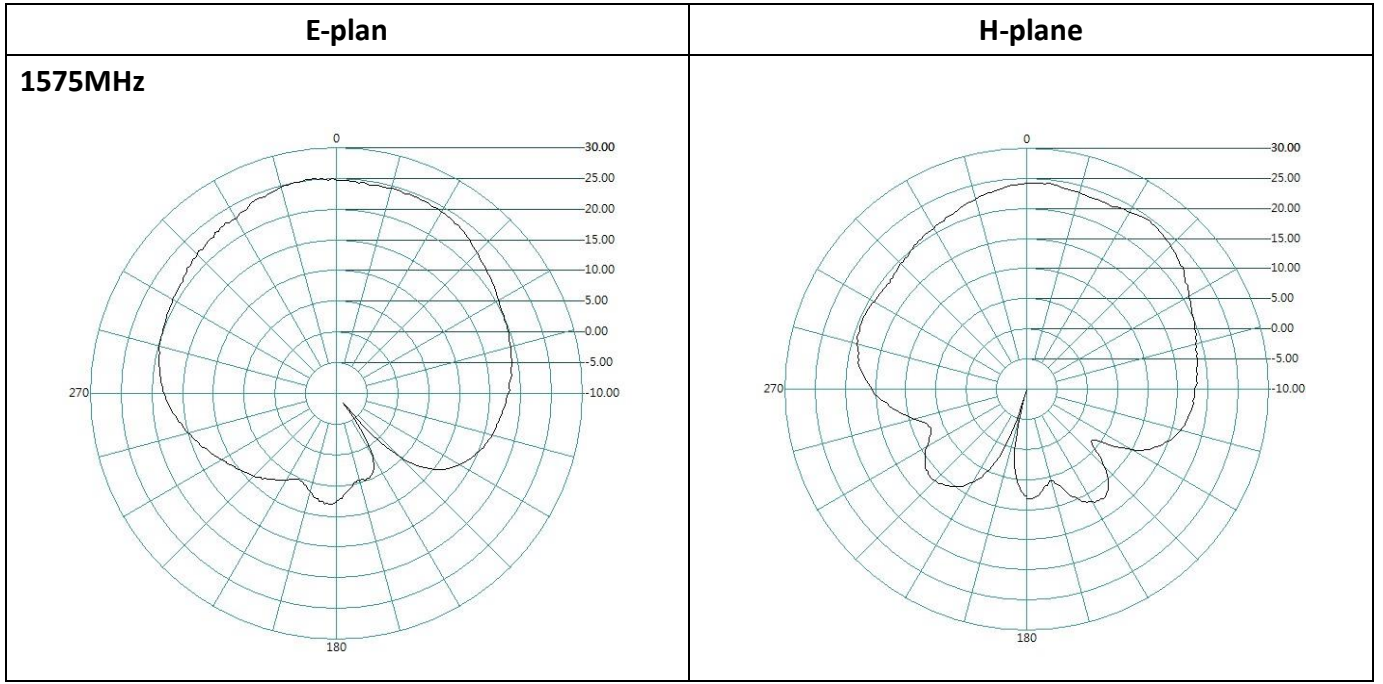

LTE Port

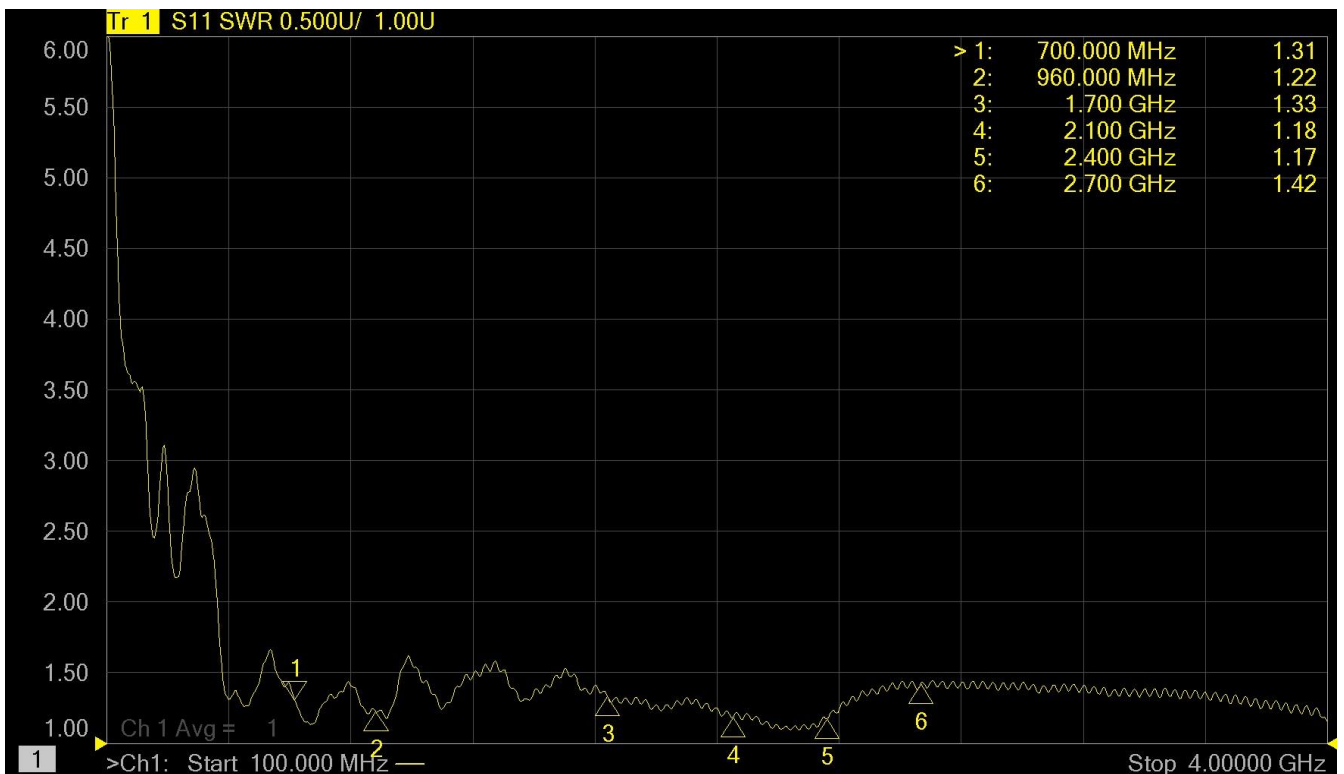
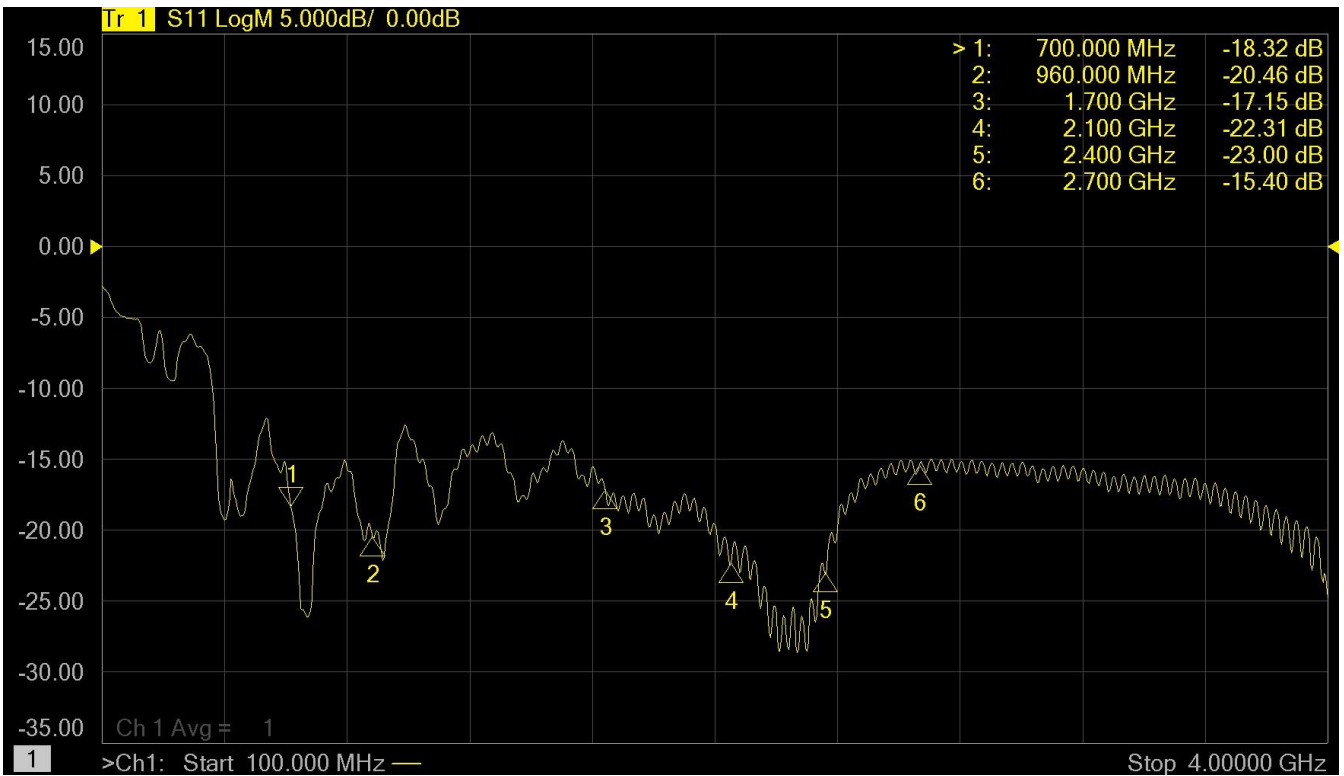

Radiation pattern

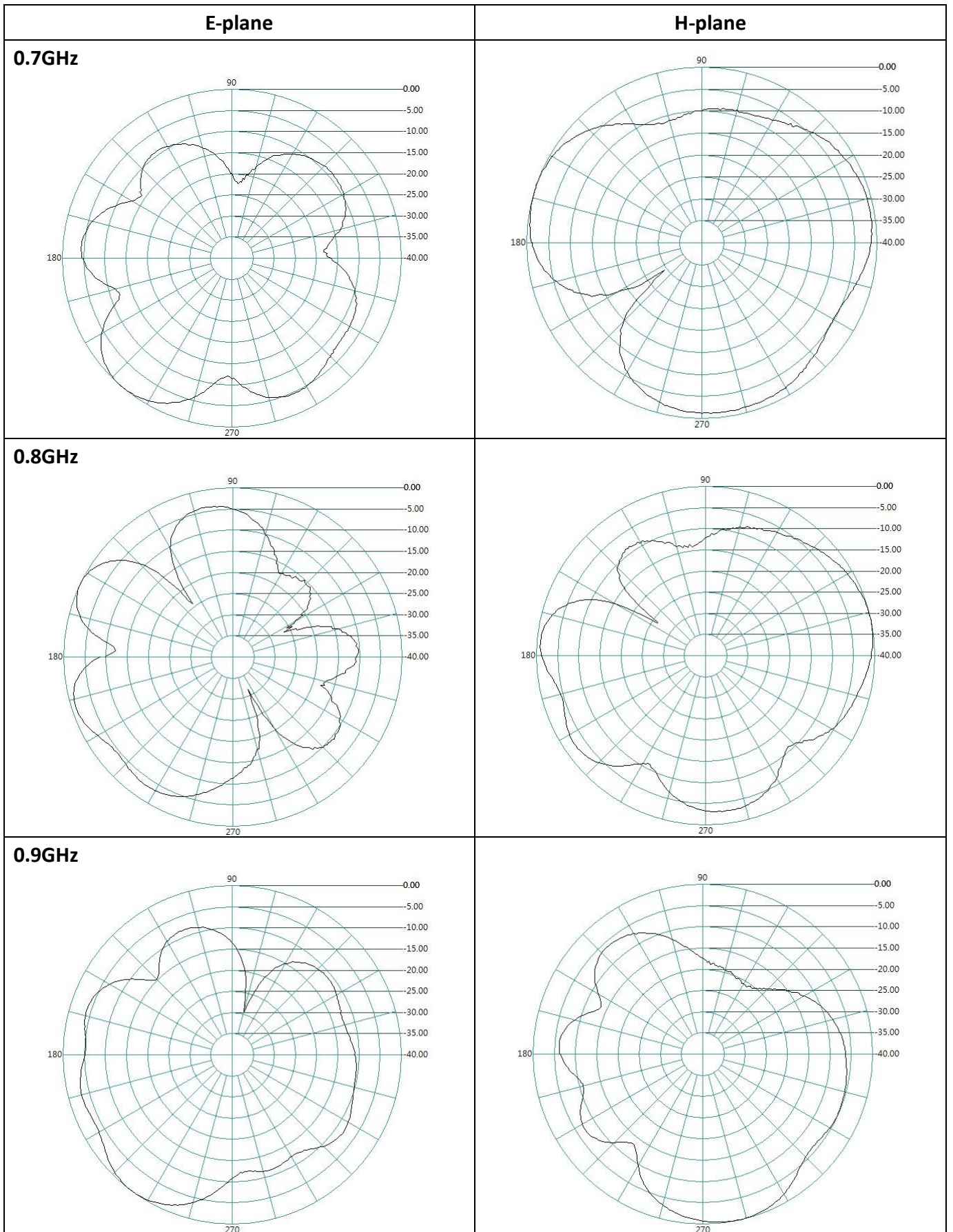

1.7GHz

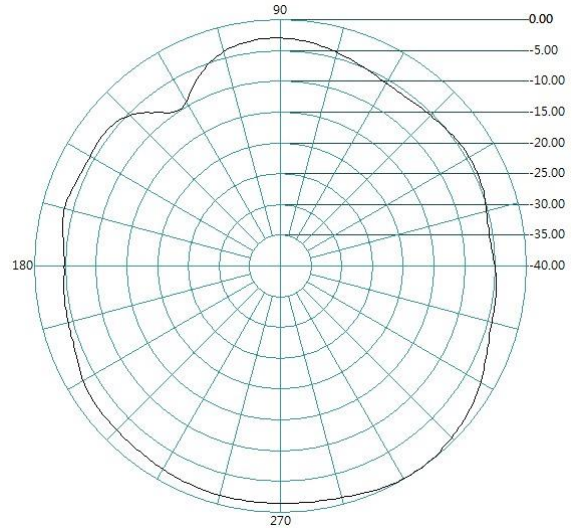
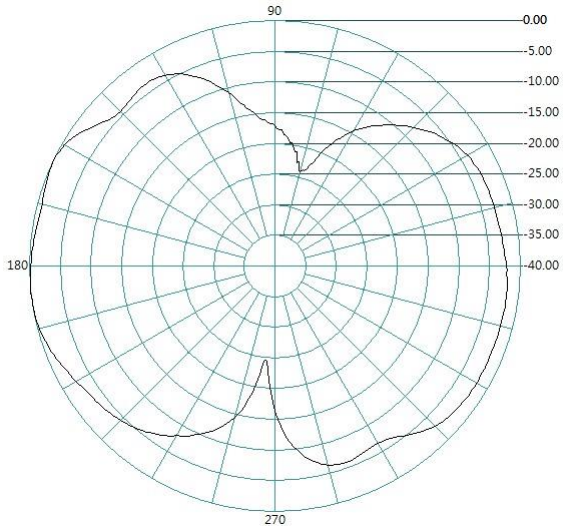

1.9GHz

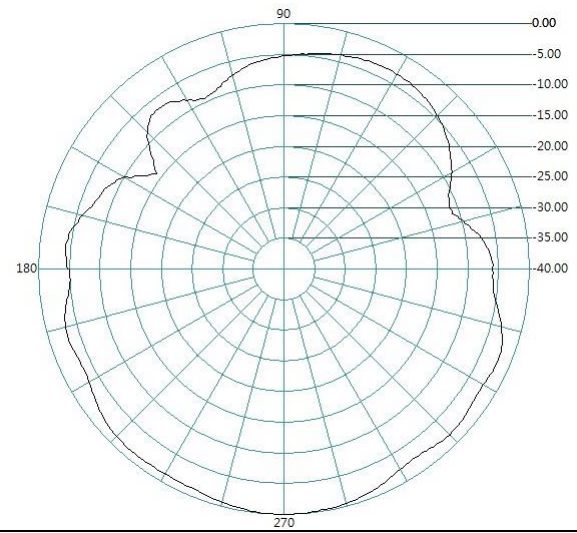
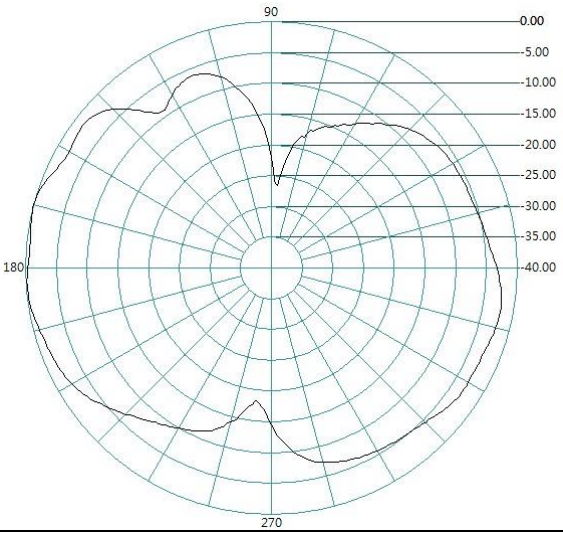

2.1GHz

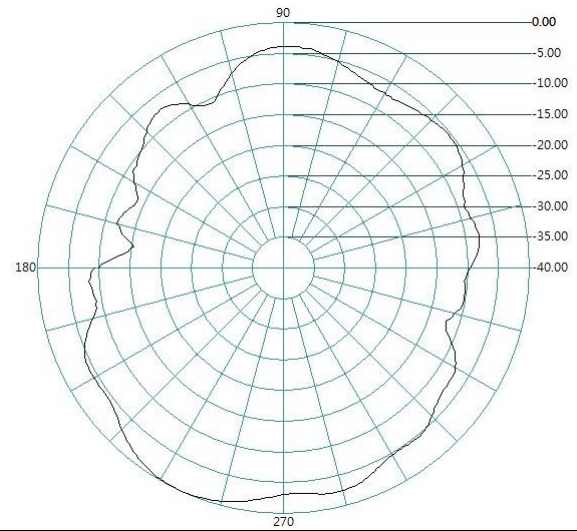
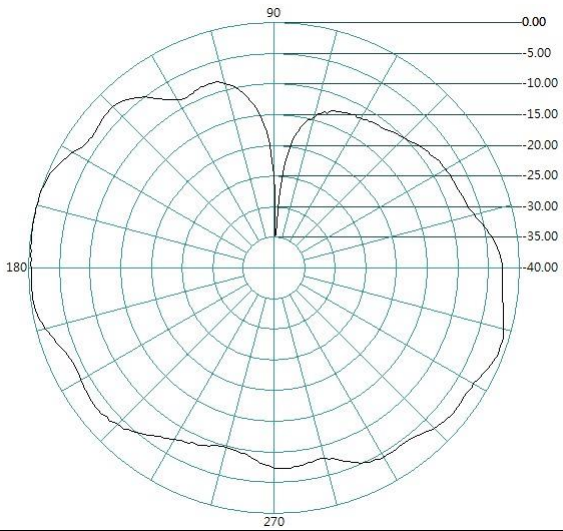

2.4GHz

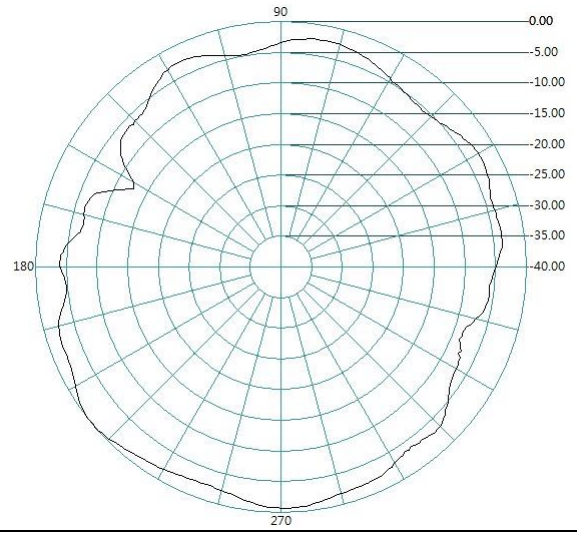
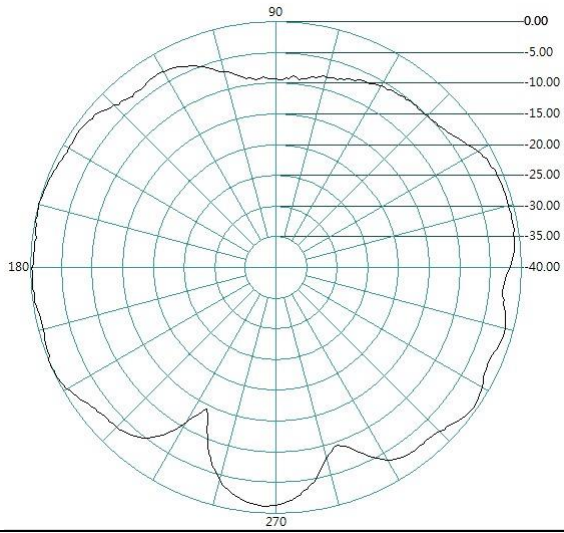

2.7GHz

