

CELLINK NEO 8⁺S

[User's Manual]



Note

The specifications listed in this manual are subject to change without the advanced notice.

This product is an external power supply, which is used to provide extended dash cam recording when the vehicle is parked, without depleting or damaging the vehicle's battery. This manual outlines the basic steps required to install and use the external battery.

▶ Name and Function of each terminal



- **INPUT** : The charging connector for connecting to the Cigar lighter socket, ACC Power and continuous Power contacts in Fuse box
- **OUTPUT** : The discharging connector for connecting to the dashcam.
- **FIX/OFF/ADJ** : The switch for adjusting the charge current.
 - ▷ **FIX** : It makes be possible to charge by only Minimum Charge Current of the product and not possible control to the charge current with App.
 - ▷ **OFF** : System power off.
 - ▷ **ADJ** : It makes be possible to control the charge current between Min. to Max. with App
- **F/W** : The connector for firmware up-date only(Technician Use Only)
- **USB** : The 5V output connector for charging a mobile product as a Smart phone
- **EXT.Battery** : Connector for connecting to an extra battery such as CELLINK NEO EXT to add the capacity.
- **LED Display** : Red - charging, Green - Fully charged, Blue - Bluetooth connected
When the switch is turned on, 3 LEDs are flashing for a while.

▶ General Specifications

Input Power	▷ When connected to the Cigar Lighter Socket : FIX only		DC 12V~17V_Max. 6A
	▷ When connected to the Fuse-box ACC Power : ADJ only		DC 12V~17V_Max. 13.5A
Output Power	▷ Dashcam connector		DC 11.0V~14.2V_Max. 2A
	▷ USB connector		DC 5V_Max. 2A
Charging Voltage & Current	FIX	▷ When connected to the Cigar Lighter Socket	DC 14.2V_Max. 4.5A
	ADJ	▷ When connected to the Fuse Box ACC power	DC 14.2V_Max. 8.5A
Charging time -FIX : Fixed current -ADJ : Adjusted current	FIX	▷ 4.5A Charging : Approx. 100minutes	
	ADJ	▷ 8.5A Charging : Approx. 50minutes	
	Switch Status		
Product Rating	▷ 12.8V, 7500mA, 96Wh		
Availible Hours	▷ About 24Hours		
	※Based on 2CH dashcam within 4Wh power consumption.		
Dim. and weight	▷ 151(W)*207(L)*32.6(T)mm / Approx. 1.45kg		
Battery used	▷ LiFePO4		

The CELLINK NEO8+S is designed to power your dashcam in Parking Mode for extended periods of time without using your vehicle's battery.

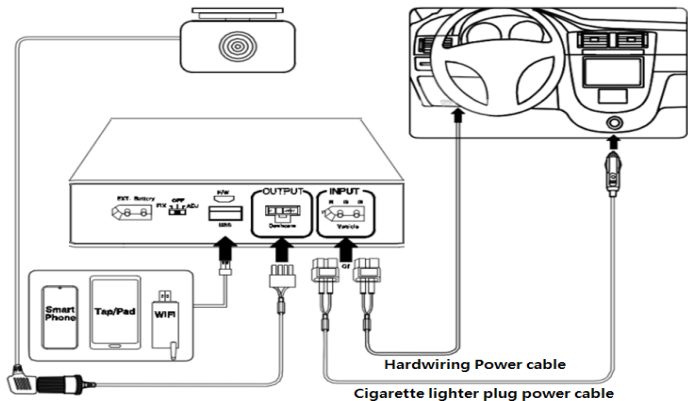

Product Properties

1. Bluetooth is built in, so the user can check the battery status in real time, including the time available and estimated charging time through the smartphone APP.
2. When the switch is set to ADJ, the smartphone APP allows the user to set the charging current of the product from minimum to maximum current.
3. CELLINK NEO8+S offers the 2 types charging methods such as the vehicle's cigar-lighter plug and fuse-box ACC power connection.
4. Charging starts as soon as the vehicle starts the engine, if the ADJ on the switch is selected, the users can change the charging current through the APP on the smartphone.
5. For better battery safety, a constant current constant. voltage charging circuit and a secondary protection circuit are built in.
6. A micro controller (MCU) is built in to control the current, voltage and voltage balance of the battery, and the battery protection circuit module is built in for secondary protection to prevent the over-charge, over-discharge and over-current.
7. If you need more capacity, the CELLINK NEO EXT battery can easily make to increase the capacity by connecting only the cables provided with the CELLINK NEO EXT.
8. The APP will put up a warning screen when the temperature inside the battery get to a certain temperature, and the system will automatically stop to prevent overheating if the product is in excess of 80°C.
9. The battery will be automatically cut off the current when the reverse voltage input or external short-circuit of the product's connectors occur.
10. The cycle life is improved more three times than the general Li-ion battery because of The lithium-phosphate iron (LiFePO4) battery is used, and we guarantee at least 1,500 cycles.
11. Compact design makes possible to install in confined spaces such as vehicle seat below.

※ Please set to the power-off before installation.

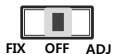

1. When connecting the product using the cigar-lighter socket Input cable.

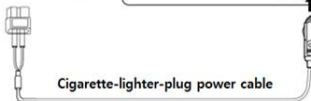
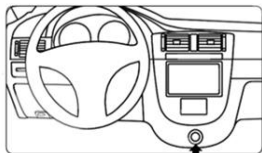
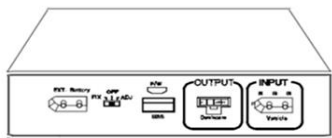

Cigarette-lighter-plug power cable

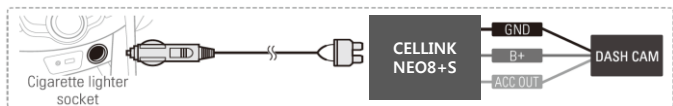

2. When connecting the product using the Fuse-box ACC Input cable.

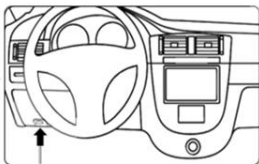
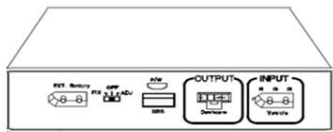

Hardwiring Power cable

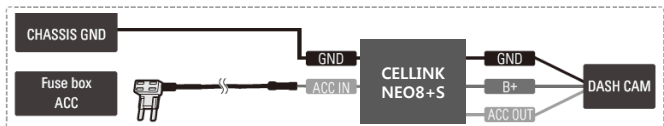

● Fuse box ACC contacts is supplied with power only when the engine is powered on.

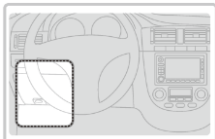

- 1) With the product's power switch in the OFF position, connect the Input(charging) cable for the fuse box and output cable to the product's cable connectors.
- 2) Open your vehicle's fuse box, check the fuse standard, and select the correct fuse holder between the included fuse holders.

Note

The fuse box location in the vehicle may vary depending on the manufacturer and model of your vehicle. For more information, refer to your vehicle's manual.

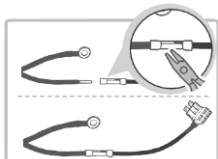

- 3) Insert the input cable into the sleeve at the end of the fuse holder cable, and then secure it by squeezing on the sleeve using appropriate tools, such as pliers.
- 4) After removing the ACC contact-fuse of the less than 10A in the fuse box, put the ACC contact-fuse provided with product in the fuse holder, and then install the ACC fuse holder in the fuse box.

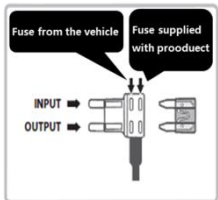

Caution

Insure that the fuse holder is installed into the continuous power contact-fuse position in the fuse box.

- 5) Find a bolt fixed on the vehicle's and connect the ground (GND) cable to the bolt.

Note

If the vehicle's bolt is coated, remove the coating before connecting the ground (GND) cable. The power may not be supplied correctly due to the coating.

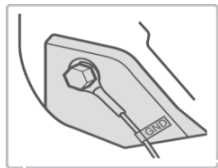

■ Make sure that the product is connected properly

- 1) Fix the product using the provided velcro tape on the car floor such as under the car seat.
- 2) Turn on the switch and check that the LEDs operate properly (Refer to the LED Display table).

[App download]



1. Search for "CELLINK Neo Plus" and download the CELLINK Neo Plus App.
2. The Android users use the "Google Play" .
3. The iPhone users use the "App Store" .



[Before running the App]

Turn on the battery you purchased before running the downloaded app
Set to the power switch position is FIX or ADJ.



FIX OFF ADJ

[How to Connect the App to the Bluetooth]

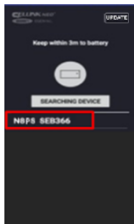

1. When running the App on the smart phone, after loading, appear the "SEARCHING DEVICE" and the searched Bluetooth device as shown on the left picture.
2. click "N8PS" on the searching list.
3. If you rescan, the connected device is displayed in blue and automatically connected.

Caution

Check the code attached on the bottom of the purchased product and click the same code on the smartphone to complete the installation.

[Main Screen Description]

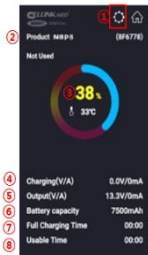

1. The product's settings.
2. The product model name and the Bluetooth ID built-in to the product.
3. The Battery's charging state and the internal temperature.
 - The animation image is changed during charge and discharge.
 - Displayed in red : during charge.
 - Displayed in blue : during discharge and 100% full charge.
4. The present voltage and charging current to the battery.
5. The present voltage and discharge current from the battery.
6. The capacity of the product.
7. Estimated time to full charge(displayed "0" during discharge) at the present input power level.
8. Available time as the current state(displayed "0" during charge) at the present output power level.

Note

The App doesn't always need to be turned on. However, if the battery's internal temperature is high or input voltage is low, you can receive an alarm message during the App is turned on.

[Product password setting]



- You can enter the product setting screen by tapping the gear icon(1) on the main screen. The password is required to enter the product setting screen. The initial password is set to 1234.
- You can set your own password to prevent other users from changing the product settings at will .
 - It is recommended to change the password immediately after purchase.
 - The "0000" cannot be used as a password and able to set within 0001~9999.

Note

If you have forgotten your password, please contact our Customer Service Center.

[Product setting Screen]

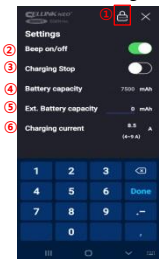

1. Padlock Icon : User's own password setting.
 - Your own password setting makes sure to prevent others from changing the product settings.
2. Beep on/off : Setting status of battery sound. (initial value : on)
3. Charging Stop : The function to stop charging the battery.
4. Battery capacity : means the nominal capacity of the product.
5. Ext. Battery capacity : When you add an Extended battery pack like as "CELLINK NEO EXT7", enter the capacity of the added battery.
6. Charging current : You can change the charging current when you install the battery to the fuse-box and the switch is selected to the ADJ. Please enter the current within "4A~9A".

[Warning to battery high temp]



- The warning screen will be displayed and stop charging or discharging if the internal temperature is more than 80°C to prevent the vehicle's and product's damage.

[Warning to input voltage low]



- The warning screen will be displayed and stop charging if the input voltage drops below 12V to prevent the vehicle's damage.

▶ How to add the capacity to CELLINK NEO8+S

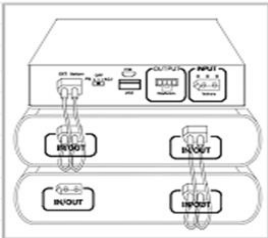

1. If CELLINK NEO8+S needs more capacity, connect the extended battery pack such as CELLINK NEO EXT7.
2. CELLINK NEO EXT battery is designed to add the capacity to CELLINK NEO8+S easily.

■ EXT. Battery Installation Guidance

1. Connect CELLINK NEO EXT™ IN/OUT connector to the EXT. Battery connector of CELLINK NEO8+S using the cable provided with the CELLINK NEO EXT product.
2. After installation the EXT Battery product, enter the capacity of the product connected to CELLINK NEO8+S on the App.

⚠ Caution

Make sure to connect the voltage of the extended battery is higher than the voltage of CELLINK NEO8+S when connecting the extended battery to add the capacity to CELLINK NEO8+S. It can make the functional problems in case of the extended battery's voltage is lower.

▶ Precautions on handling

Mishandling of CELLINK NEO8+S batteries can lead to degradation of performance and result in problems related to heating, ignition, explosion etc. As such, it is advised to check the following details.

1. When installing on vehicles, please use only the original cable provided with the product.
2. When storing the battery, keep out of direct sunlight and do not store in a high-temperature environment such as inside the car in hot weather.
3. Do not place the battery in microwave oven or a place with high pressure.
4. Do not throw or give the battery any types of shocks.
5. Do not repair or remodel the battery on your own.
6. Keep the battery out of contact of water or other liquid.
7. Do not disassemble, compress or drill a hole on the battery using sharp equipment.
8. Keep the battery out of contact of children or pets.
9. When there is a strange smell during use, discontinue using the product and exchange with a new product.
10. When the battery is inflated during use, discontinue using the product and exchange with a new product.
11. Do not use the battery in a static environment as it can affect the performance of protection circuit of the battery.
12. Keep the connection terminal of the charging cable of the battery out of contact with conducting elements.
13. Never use the product for anything else other than the power supply for Dashcam.

▶ Disposal guidance of battery

1. Don't throw away your batteries, separate them with recycled items.
2. Do not incinerate battery and put in the fire. Heat may cause explosion and fire.
3. Do isolate them each other when disposing the secondary batteries having different electrochemical systems.
4. Dispose of the battery in discharged state to prevent heat by short circuiting.
5. Disposal guidance of batteries may depend on each country and region, there for dispose batteries in accordance with the regulations for each country and region.

▶ Product Warranty

- The warranty period of this product is 1 year from the purchase date.
- If the product fails during normal and correct use within the warranty period, our service center will repair the product free of charge.
- Any disassembly, modification or alteration of the product will void the warranty.
- The cost to repair or fix any malfunction or problem caused by incorrect usage during the warranty period may be charged to the consumer.
- The manufacturer shall not be responsible or liable for any loss or damage caused by incorrectly using the product.

▶ Customer Service

- Manufacturer : EGEN Inc.
- Address : 61, Dongtangiheung-ro, Dongtan-myeon, Hwasung-si, Gyeonggi-do,
Republic of Korea
- Customer Service Website : www.egens.co.kr

