

**POOLIN®**

# Operation Manual

EOC05 Series



# Content

---

## Important Safety Instructions

---

Hazard Warning .....	4
Safety Instructions .....	4-5

## Names of Machine Parts

---

Names of Machine Parts .....	6-7
Embroidery Unit .....	8-9

## Turn On/Off the Machine

---

Turn On/Off the Machine .....	10
Mode Selection Page .....	11
Language Settings .....	12
Connect to Institch Cloud .....	13-14

## Embroidery Frames Introduction

---

Embroidery Frames Introduction .....	15
--------------------------------------	----

## Thread Settings

---

Upper Threading .....	16-19
Install the Bobbin .....	20-21
Wind the Bobbin Thread .....	22-24

## Replace the Needle

---

How to Replace The Needle .....	25-26
---------------------------------	-------



# Content

---

## Installing/Removing the Embroidery Unit and frame

---

Install the Embroidery Unit .....	27
Remove the Embroidery Unit .....	28
Attach the Frame and Fabric .....	29-30
Detach the Frame .....	31

## Upper Thread Tension Adjustment

---

How to Adjust the Upper Thread Tension .....	32-33
--	-------

## Pattern Selection

---

Pattern Selection Page Introduction .....	34-36
Letter Embroidery .....	37
Institch Cloud Folder .....	38
Import Patterns from USB to Machine .....	39
Direct Embroidery from Patterns on USB .....	40
Combine Multiple Patterns for Emb .....	41

## Pattern Editing

---

Pattern Editing Page Introduction .....	42-43
Set Pattern Colors .....	44
Set Preview Background Color .....	45
Select Embroidery Frame .....	46
Letter Editing .....	47-48
Rotate Pattern .....	49

# Content

Scale Pattern .....	50
Mirror Pattern .....	51
Reset Edited Pattern .....	52
Save Edited Pattern .....	53
Delete Edited Pattern .....	54

## Pattern Embroidery

---

Pattern Embroidery Page Introduction .....	55-56
Stitch Forward/Backward .....	57-58
Color Forward/Backward .....	59

## Settings

---

Settings Main Page Introduction .....	60-61
---------------------------------------	-------

## Common Issues and Solutions

---

Common Issues and Solutions .....	62-63
-----------------------------------	-------

# Important Safety Instructions

Please take this machine seriously and do not treat it as a toy. When operating or using the machine, always observe the following safety precautions:

1. Do not operate the machine with blocked ventilation openings.
2. Do not use the machine outdoors.
3. Do not operate the machine in areas where aerosol (spray) products are being used or where oxygen is being administered.
4. To disconnect the machine, turn the main switch to the "O" (Off) position.
5. Do not unplug the machine by pulling the cord. Always grasp the plug—not the cord—when unplugging.
6. Keep fingers away from all moving parts, especially around the needle area.
7. Do not use a bent needle.
8. Do not pull or push the fabric while embroidering. This may cause the needle to bend or break.
9. This embroidery machine is not intended for use by young children or individuals with reduced physical or mental capabilities without supervision.

4

## WARNING

### Instructions for safe operation:

1. Pay attention to the needle during embroidery, and avoid pulling the thread directly, touching the hand wheel, needle or other moving parts.
2. Please switch the machine to the symbol "0" to turn it off and unplug the machine from the outlet under the following circumstances:
  - Operation completed
  - Replacing or disassembling embroidery needles or any other parts
  - Power failure occurs during use
3. Plug the machine directly into the electrical outlet, do not use an extension cord.
4. Do not place or store the machine near any extreme environment (high temperature, low temperature, high humidity or dust area), heater or other thermal appliances, so as not to cause machine failure.

# Important Safety Instructions

5. The plastic bag that this machine was supplied in should be kept out of the reach of children or disposed of. Never allow children to play with the bag due to the danger of suffocation.
6. Do not place the embroidery machine on an unstable or inclined table, otherwise the machine may fall, resulting in injuries.

## For a longer service life:

1. When storing the machine, please avoid direct sunlight and high humidity locations. Never use or store this machine near heaters, irons, halogen lamps, or other hot objects.
2. Only use neutral soap or detergents to clean the machine shell. Benzene, thinner or scouring powder can damage the machine, and should never be used.
3. Do not let the machine drop or be impacted.
4. Always consult the operation manual when replacing or installing any assemblies, needle, or other parts to assure correct installation.
5. Only the interface cable (USB cable) included with the machine can be used, and it cannot be replaced by other types of cables.

## Repair or adjustment:

In the event of a malfunction occurs or requires adjustments, first follow the troubleshooting table on the back of the operation manual to inspect and adjust the machine yourself. If the problem persists, please consult our after-sales personnel. They provide professional help and support. Never attempt to repair the machine yourself as this could cause more serious damage.

# Names of Machine Parts

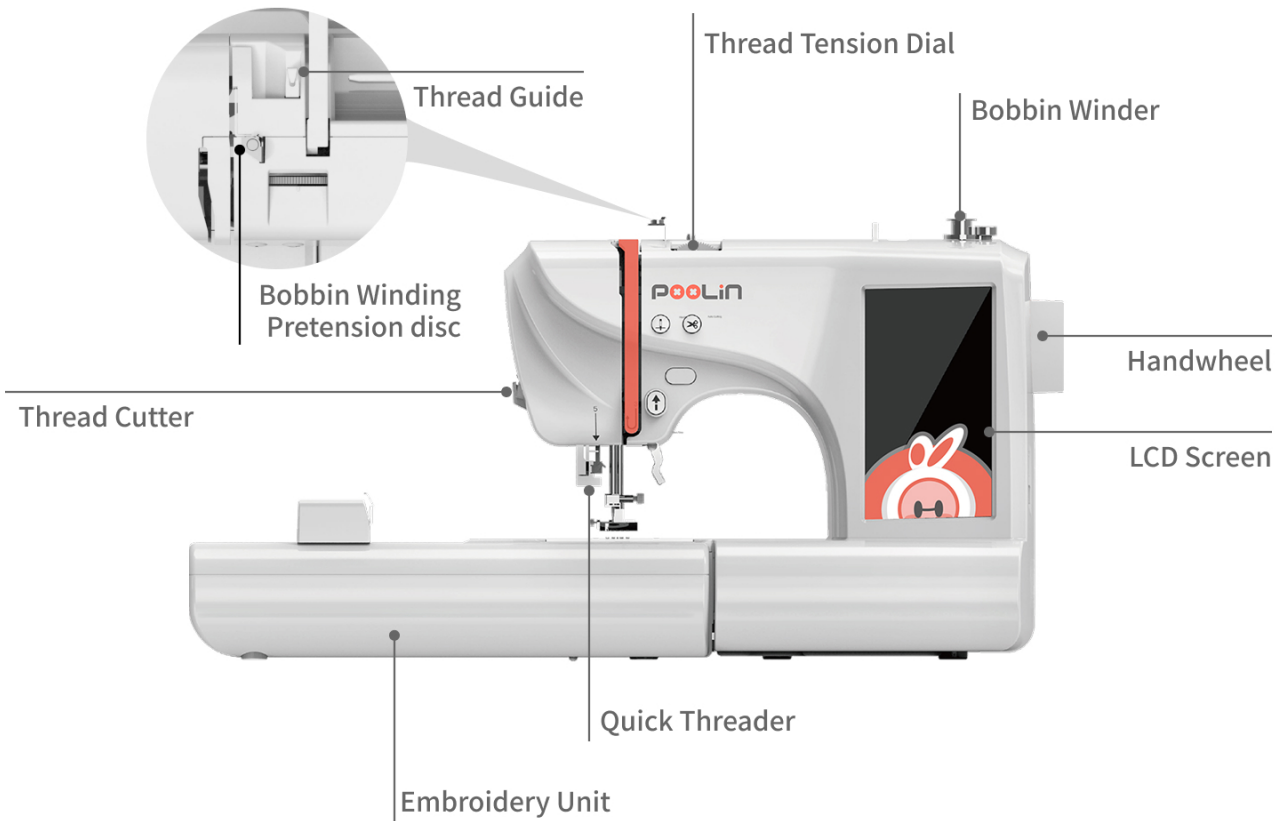

6

## Description of Functions

Contents	Description
LCD Screen	For display and operation.
Handwheel	Turn the handwheel to raise and lower the needle.
Bobbin Winder	Place an empty bobbin when winding bobbin thread.
Thread Tension Dial	Adjust upper thread tension, the larger the value, the greater the tension.
Thread Guide	Upper thread guide hook.
Bobbin Winding Pretension disc	Control the tension when winding the bobbin thread.

# Names of Machine Parts

Contents	Description
Thread Cutter	For cutting upper thread.
Embroidery Unit	After connecting, it is used to attach the embroidery frame and control the movement of the embroidery frame.
Quick Threader	Quickly thread the upper thread through the eye of the needle.

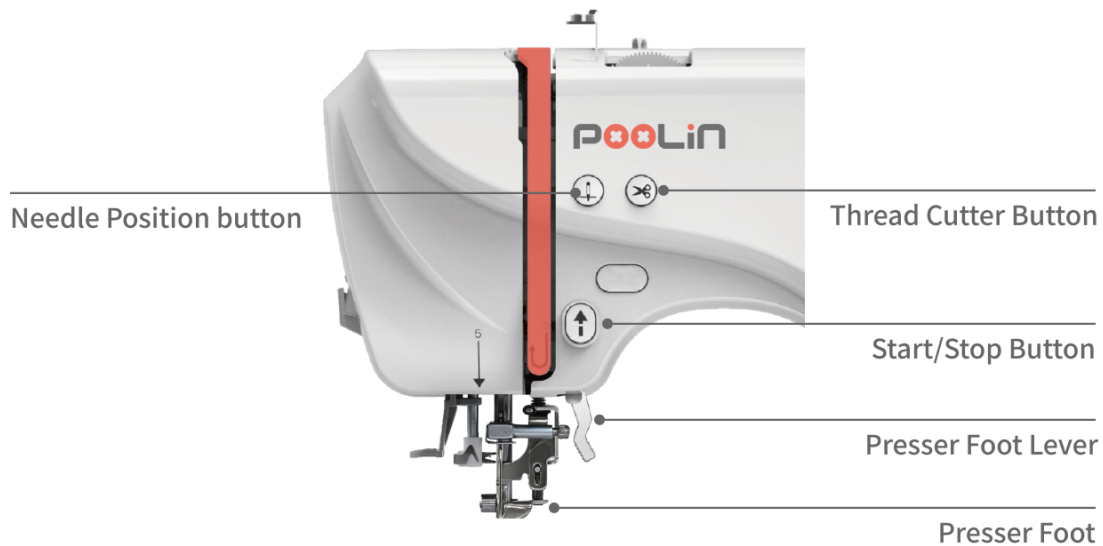

Enlarged close-up of the appearance of the fuselage

Contents	Description
Presser Foot	For fixing fabric.
Presser Foot Lever	For raising/lowering the presser foot.
Thread Cutter Button	Press the button to cut the thread.
Needle Position button	Press this button to raise or lower the needle position.

# Names of Machine Parts

Contents	Description
Start/Stop Button	<p><b>Machine Start and Stop:</b>            After pressing the button, the machine will embroider a few stitches at a slower speed, and then automatically switch to the speed set by the embroidery speed controller for embroidery. Press the button again and the machine will stop. The color of this button will change according to the operating mode of the machine to provide a more visual indication.</p>

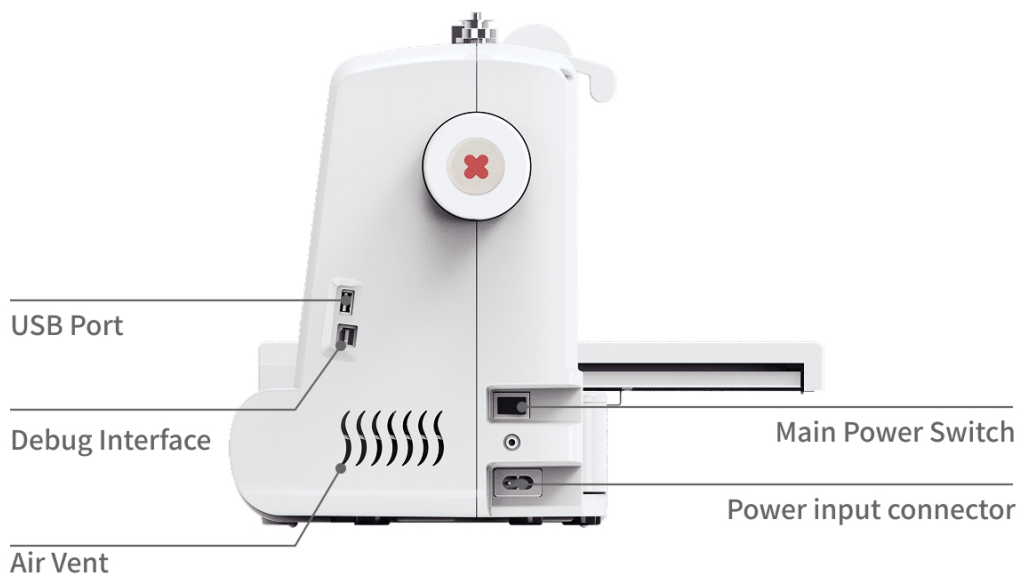

Contents	Description
USB Port	Connect USB for pattern transfer and system upgrade.
Main Power Switch	Turn on/off the machine.
Power Supply Jack	Connect the machine power cord.
Air Vent	For machine cooling.
Debug Interface	For debugging the machine. No user operation is required.

# Embroidery Unit

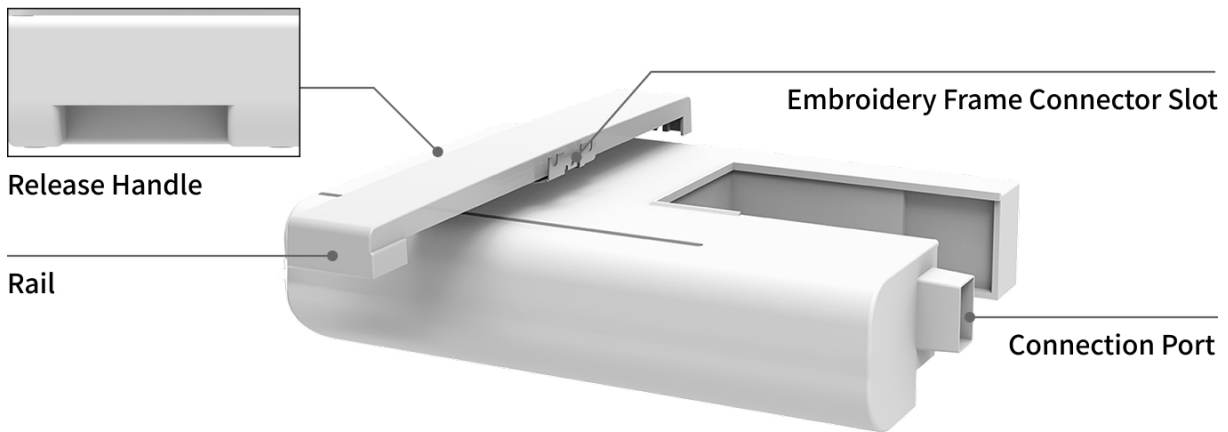

## Description of Functions

Contents	Description
Release Handle	When detaching the embroidery unit, press and hold the release handle, and then pull it outward.
Rail	Control the movement of the embroidery frame.
Embroidery Frame Connector Slot	Connect and fix the embroidery frame.
Connection Port	Connect the embroidery unit to the machine.

### Tips:

Before connecting the embroidery unit, be sure to turn off the power of the machine, otherwise the machine may be damaged.

# Turn On/Off the Machine

## DANGER

1. Use only regular household electricity for the power source. Using other power sources may result in fire, electric shock or damage to the machine:
  - Make sure the plugs on the power cord are firmly inserted into the electrical outlet and the power supply jack on the machine.
  - Do not insert the plug into an electrical outlet that is in poor condition.
2. Use only the power cord included with machine.
3. Do not use extension cords or multi-plug adapters with many other appliances plugged into them.
4. Do not touch the plug with wet hands, electric shock may result.
5. When unplugging the machine, be sure to turn off the main power first.
6. Pulling on the power cord may damage the cord, or lead to fire or electric shock.
7. Do not cut, damage, modify, forcibly bend, pull, twist or bundle the power cord.
8. Do not place heavy objects on the power cord.
9. Do not place the power cord under high temperature.

### 1 Connect the power cord.

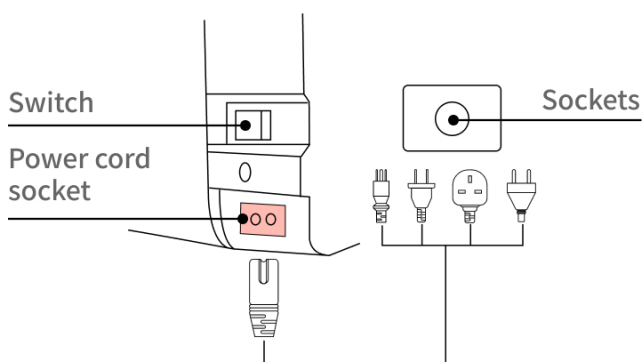

#### Tips:

Please make sure the machine is off while replacing the needle.

### 2 Set the switch to "I" to turn on the machine.

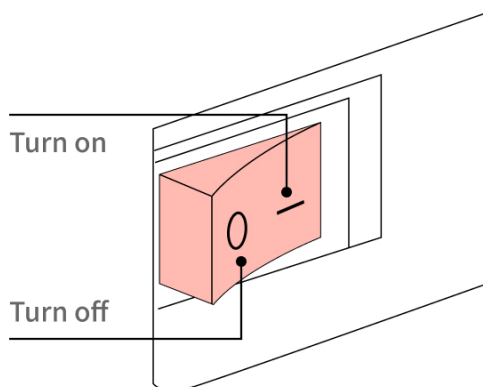



#### Tips:

Set the switch to "I" to turn on the machine.  
Set the switch to "0" to turn off the machine.

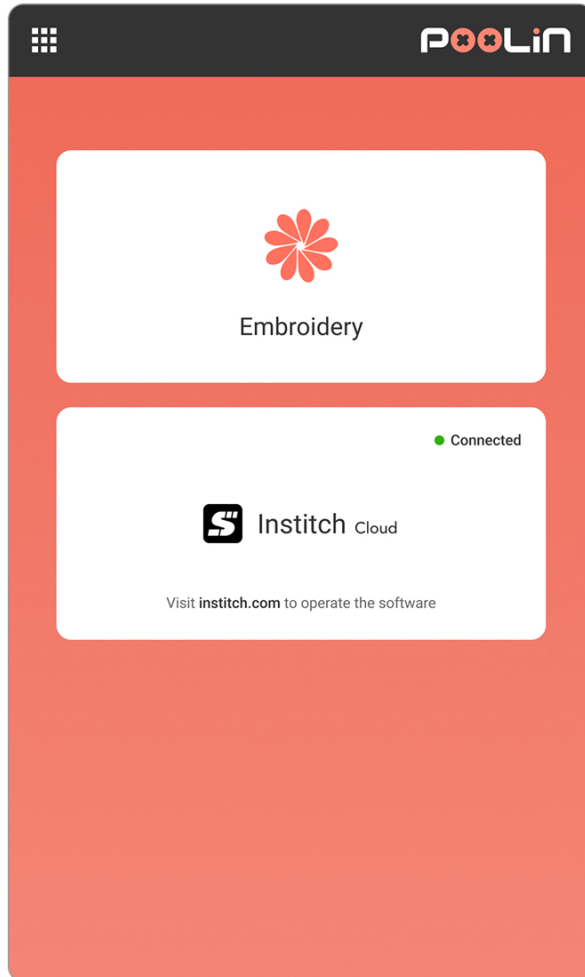
# Mode Selection Page

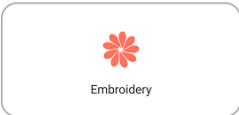

## Description of Functions

Contents	Description
	Click the button to enter the embroidery home screen, where you can select patterns and start embroidery tasks.
	The current connection status between the device and the cloud platform is displayed to confirm whether the network connection is successful.

### ⚠ Tips:

Tap the top-left corner to enter Settings, where you can switch the interface language.

# Language Settings

The factory default machine language is English, if you want to change another language, please follow the steps below to modify the language setting, and then operate the machine.

1 Tap 



3 Select your local language.

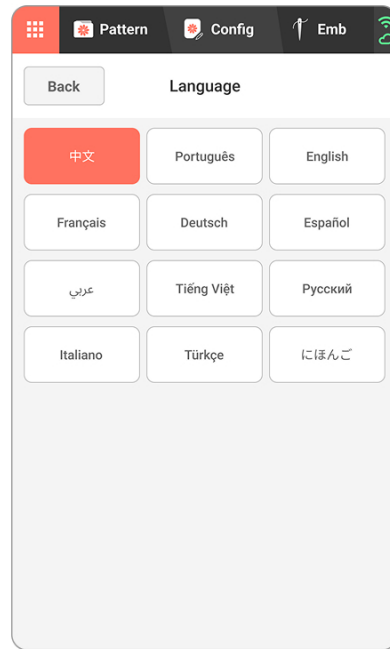

2 Tap Language Settings

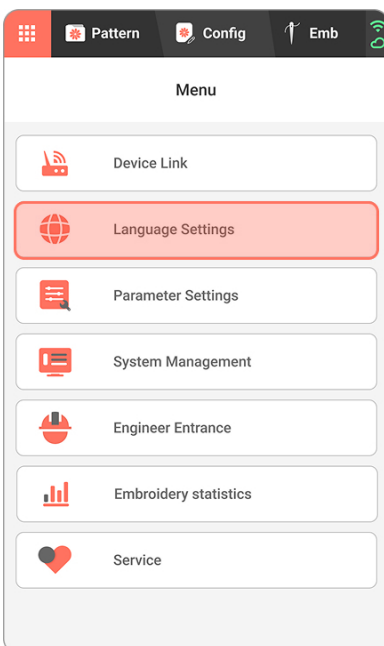

4 Tap  Enter the pattern selection page



# Connect to Institch Cloud

After successful binding, patterns will automatically sync to the Institch Cloud Platform. You can manage patterns remotely or send them to the device for real-time syncing and transfer. Please make sure the file is in DST or DSB format. For more information, visit: [Institch.com](https://Institch.com)

## 1 Tap



## 2 Tap Device Connection

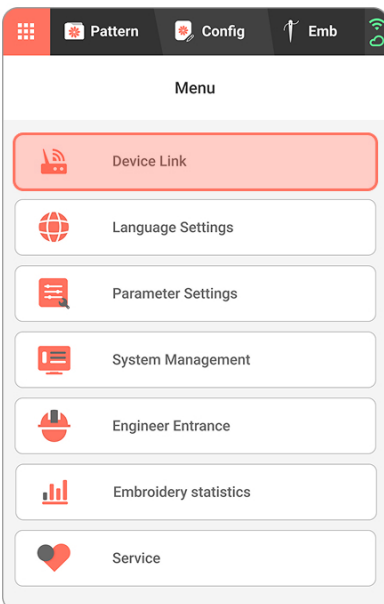

## 3 Tap Wi-Fi Settings

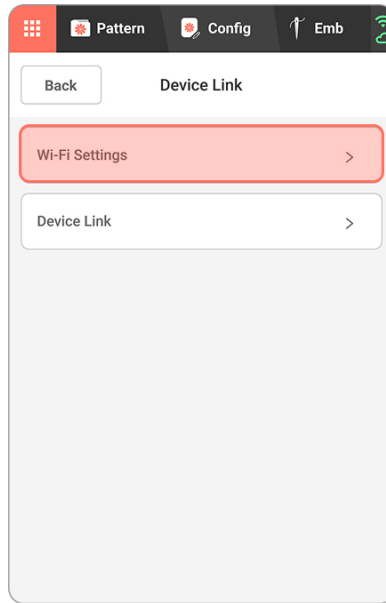

## 4 Choose a network from the list. Once connected, the current network status will be displayed.

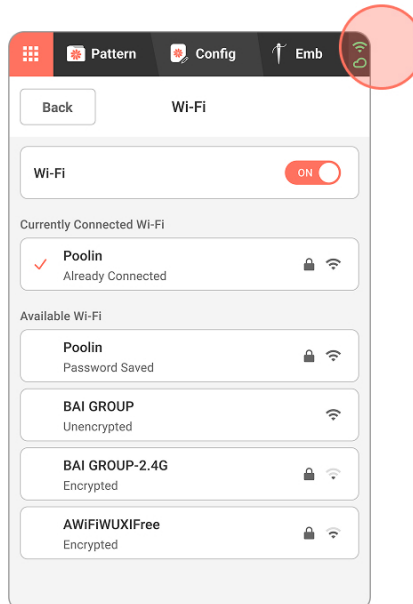

# Connect to Institch Cloud

After successful binding, patterns will automatically sync to the Institch Cloud Platform. You can manage patterns remotely or send them to the device for real-time syncing and transfer. Please make sure the file is in DST or DSB format. For more information, visit: [Institch.com](https://institch.com)

## 5 Tap Device Connection

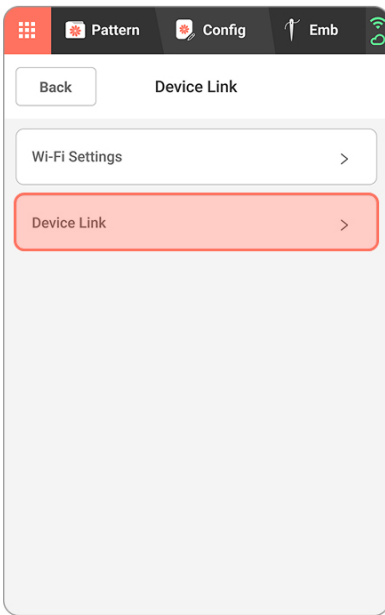

## 6 Enable Sync Patterns to Institch Cloud Platform

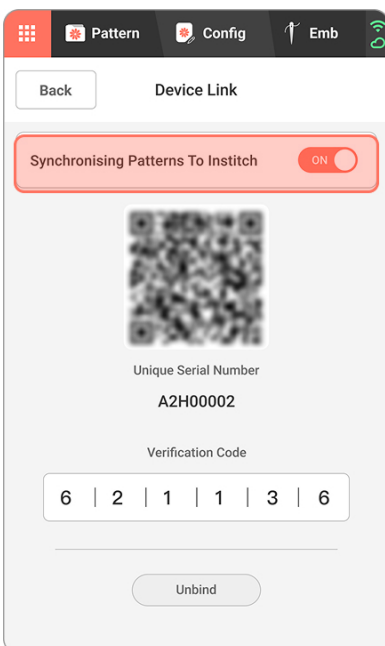

## 7 After logging into your Institch Cloud account, follow the on-screen instructions to bind your machine.

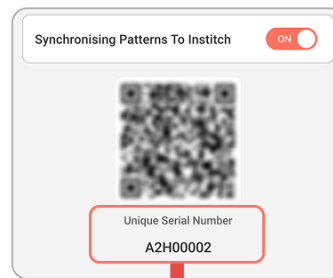

Step 1

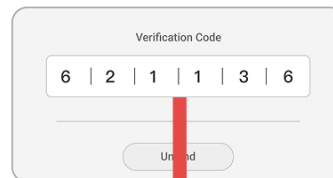
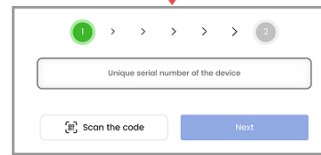

Step 2

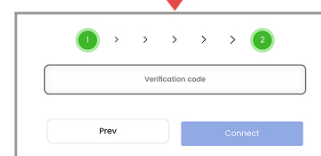

### ! Tips:

Cloud binding is a one-time setup — once bound, your device information will sync to the Institch platform.

To unbind, tap the Unbind button under Device Binding.

If you encounter any issues, technical support is available via our official social media channels.

🔍 Facebook: **Institch Doodle Digitizing**

# Embroidery Frames Introduction

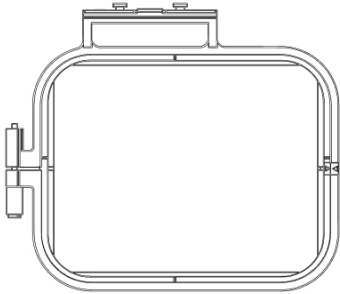

**Small Frame**

Embroidery Area:  
100mm \* 100mm  
4" \* 4"

For embroidery patterns below  
100mm × 100mm.

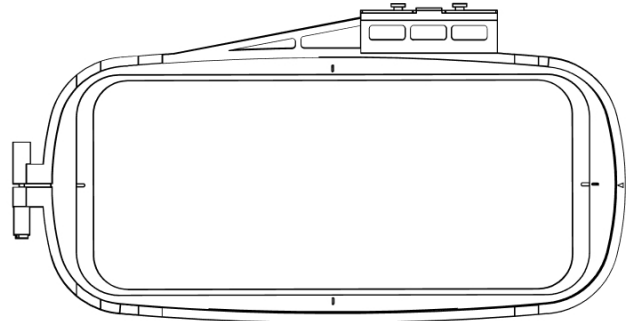

**Large Frame**

Embroidery Area:  
100mm \* 235mm  
4" \* 9.25"

For embroidery patterns below  
100mm × 235mm.

**⚠ Tips:**

Embroidery frame needs to be chosen according to the size of patterns, embroidery area should be larger than pattern.

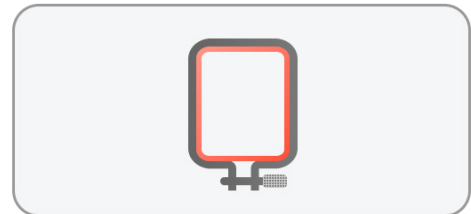
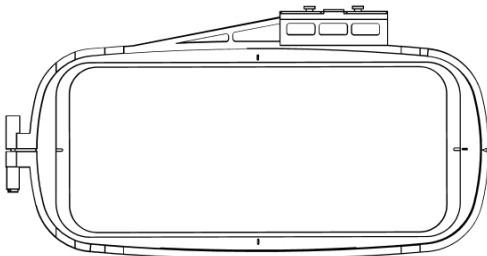
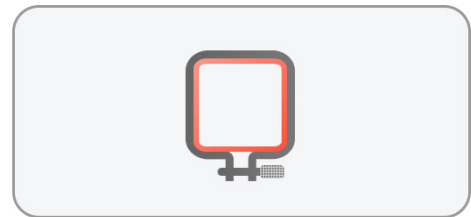
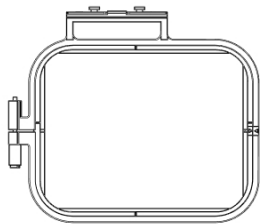

**Note:** The attached embroidery frame must match the corresponding embroidery frame displayed on the screen, otherwise the frame collision may occur, resulting in damage to the machine.

# Upper Threading

- 1 Raise the presser foot lever.

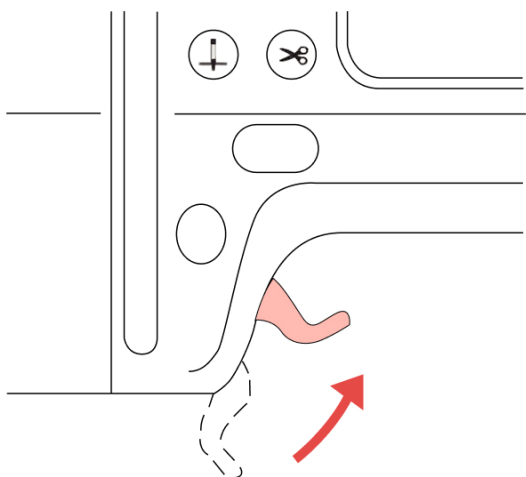

## ⚠ Tips:

Raising the presser foot lever is to ensure that the upper thread can pass through the pressure piece correctly, so that the tension of the upper thread can be adjusted to avoid thread jam, thread breakage and false alarm.

- 2 Turn the handwheel to raise the needle to the highest needle position.

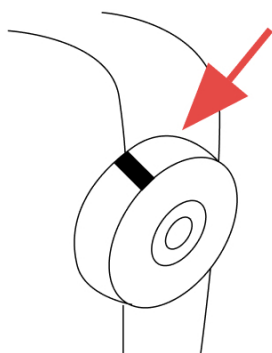

## ⚠ Tips:

If you use the easy-to-use threader to thread the needle without raising the needle position, the thread may not be threaded correctly.

- 3 Lift up the spool pin.

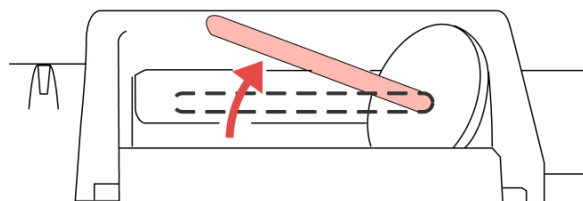

- 4 Place the spool of thread on the spool pin to make the thread spread out from the top of the thread spool.

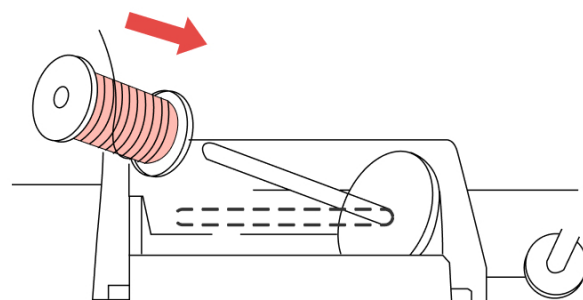

- 5 Slide the spool cap onto the spool pin.

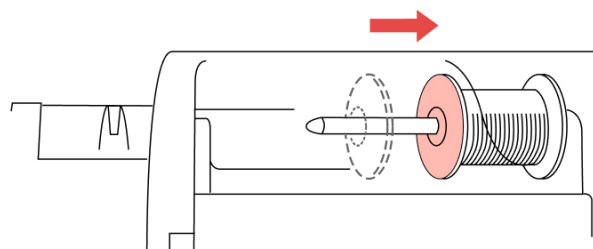

## ⚠ Tips:

Use the spool cap that is the closest size to the thread spool (large, medium, small) If you use a spool cap that is smaller than the thread spool, the thread may get caught in the slit at the end of the spool, resulting in thread and needle breakage.

# Upper Threading

- 6** Pull the thread with two hands from the spool and pass the thread under the hook of the thread guide.

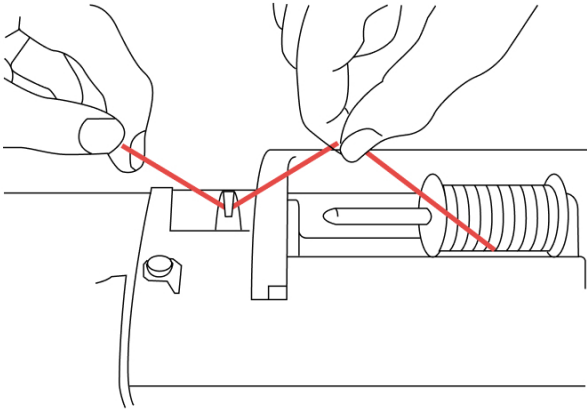

- 7** Pass the thread through the thread guide cover.

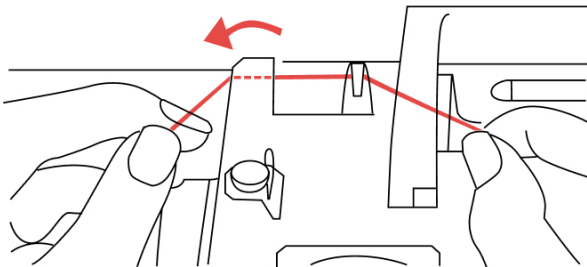

- 8** Pass between two metal sheets

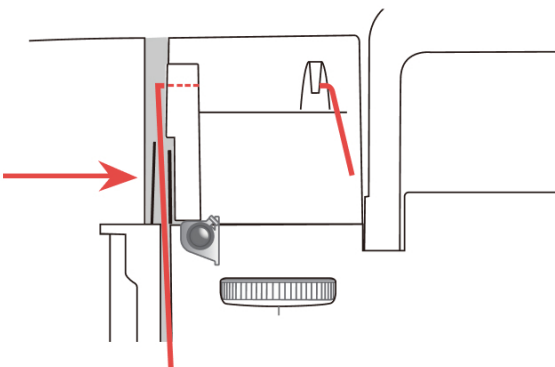

- 9** Lower the presser foot lever.

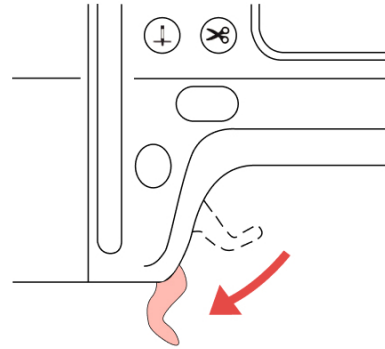

- 10** Lead the thread down, up through the spring.

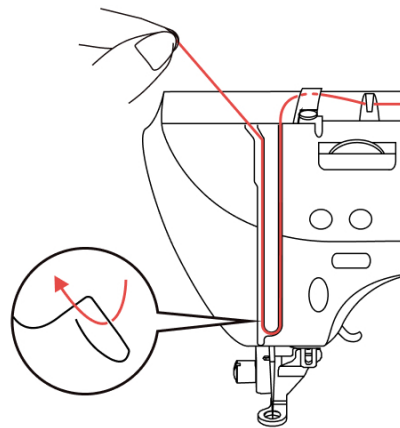

- 11** Pass the thread through the thread take-up lever.

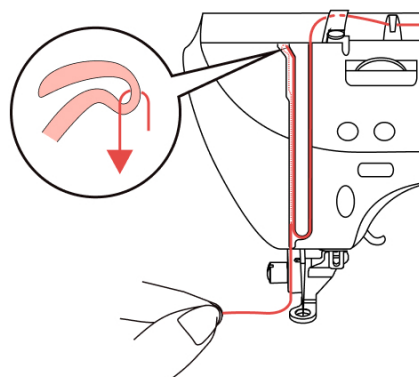

# Upper Threading

## ⚠ Tips:

When threading, please make sure to pass through the thread take-up lever, otherwise it will cause thread jam and thread breakage.

- 12** Hold the thread with two hands and pass the thread through the needle bar thread guide.

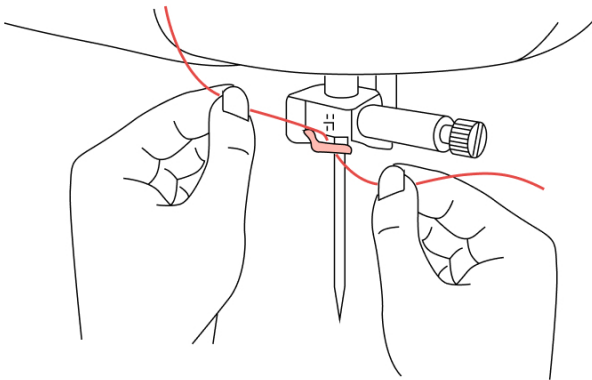

- 13** Pass the thread through the thread guide disk as shown in the figure.

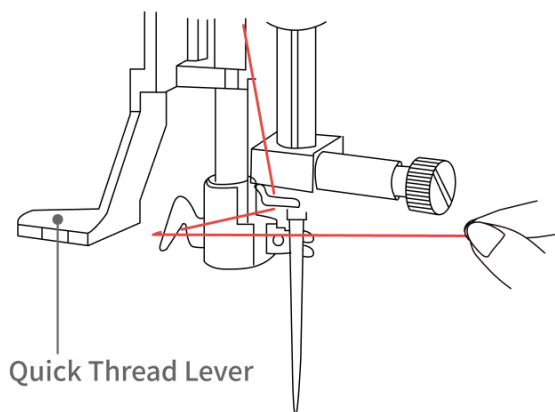

- 14** Lower the quick threader lever as much as possible.

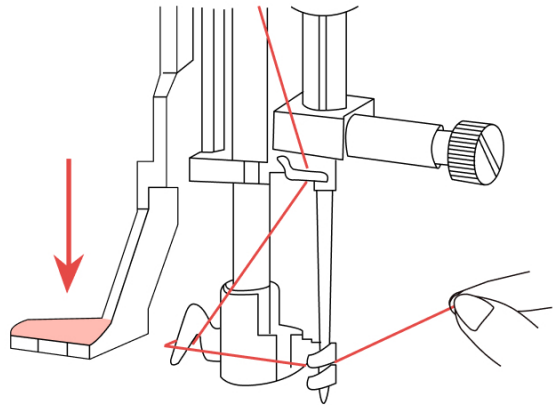

- 15** After the hook of the quick threader passes through the eye of the needle, hang the thread into the hook and lift the thread upwards.

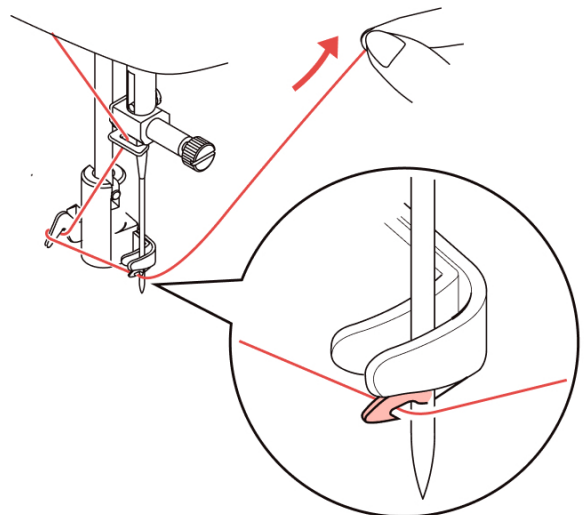

# Upper Threading

16

While releasing the needle threader lever, the thread passes through the eye of the needle, and a thread loop is formed on the back of the eye of the needle, pull the loop of the thread through the eye of the needle by hand.

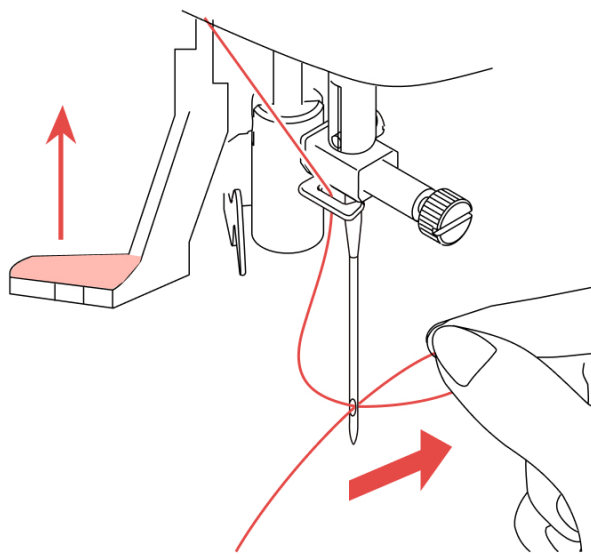

**⚠ Tips:**

Please be careful not to prick your fingers when pulling the thread out of the eye of the needle.

17

Pass the thread through the presser foot and use the thread cutter on the side of the machine to cut the thread.

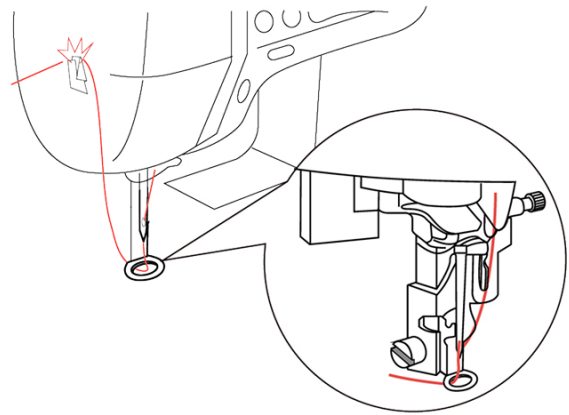

**Note:** When the needle threader cannot be used, manually pass the thread through the eye of the needle from front to back.

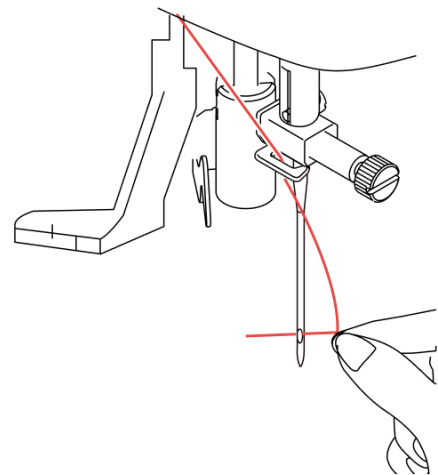

**⚠ Tips:**

After the thread passes through the eye of the needle, you need to ensure that the length of the thread end is about 80mm.

# Install the Bobbin

- 1 Slide the bobbin cover latch to the right, and remove the bobbin cover.

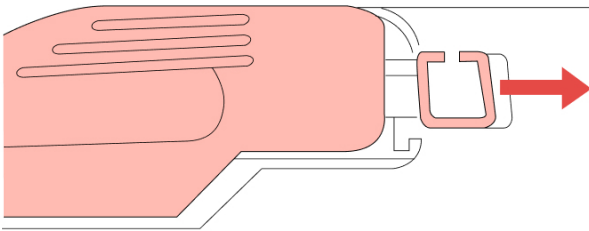

- 2 Hold the bobbin with your right hand, pull the end of the thread with your left hand, keep the direction of the thread counterclockwise, and insert the bobbin.

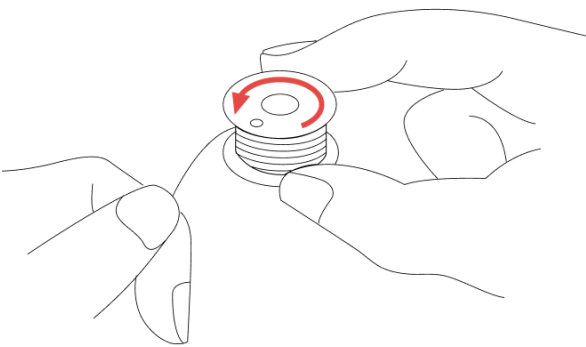

## ⚠ Tips:

Please make sure that the thread direction is correct when installing the bobbin, otherwise it may lead to thread breaking or incorrect tension of the thread.

- 3 Lightly hold down the bobbin with your right hand, and pass the thread through the spring of the bobbin case with your left hand.

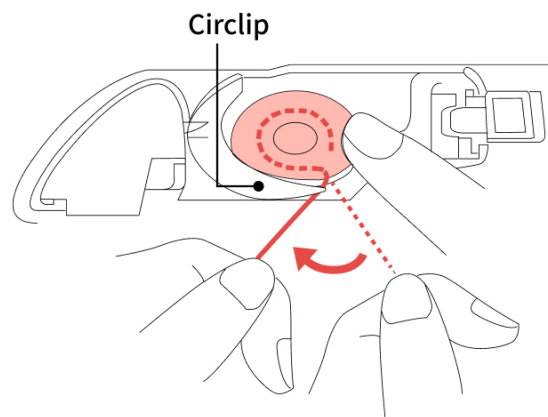

## ⚠ Tips:

Please make sure that the bobbin thread passes through the spring of the bobbin case correctly, otherwise the thread may break or the thread tension will be incorrect.

- 4 Pass the thread through the slot as shown in the figure, then pull the thread out towards the front

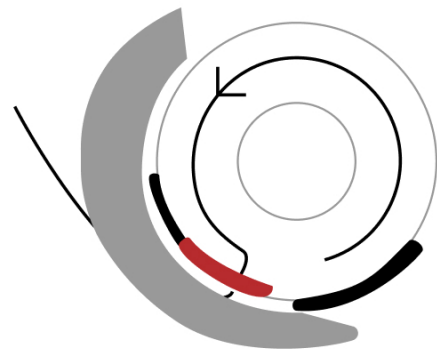

# Install the Bobbin

- 5 Then use the built-in cutter to cut the thread.

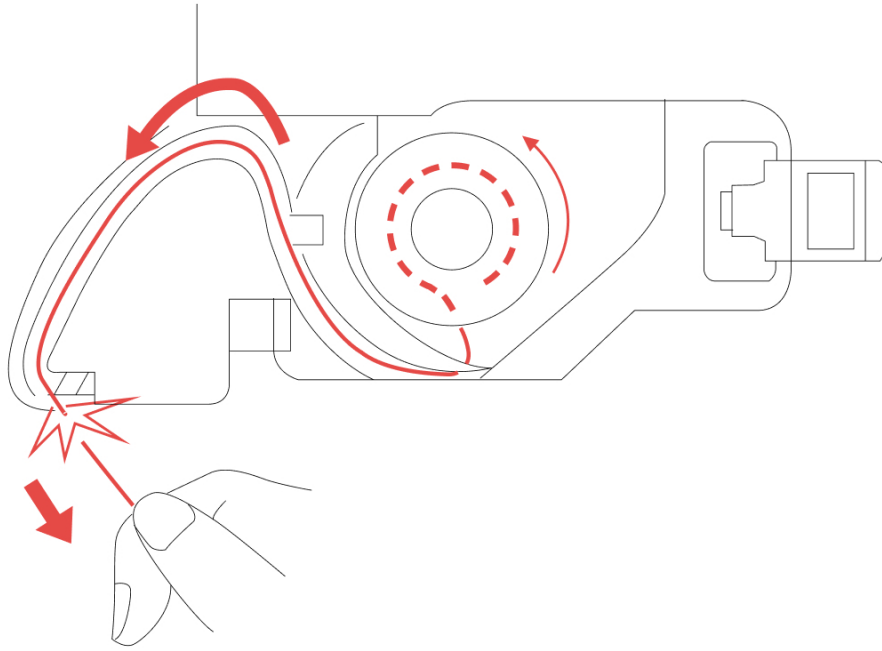

- 6 Insert the raised part of the bobbin cover into the slot on the left, and lightly press the cover on the right side to reattach the bobbin cover.

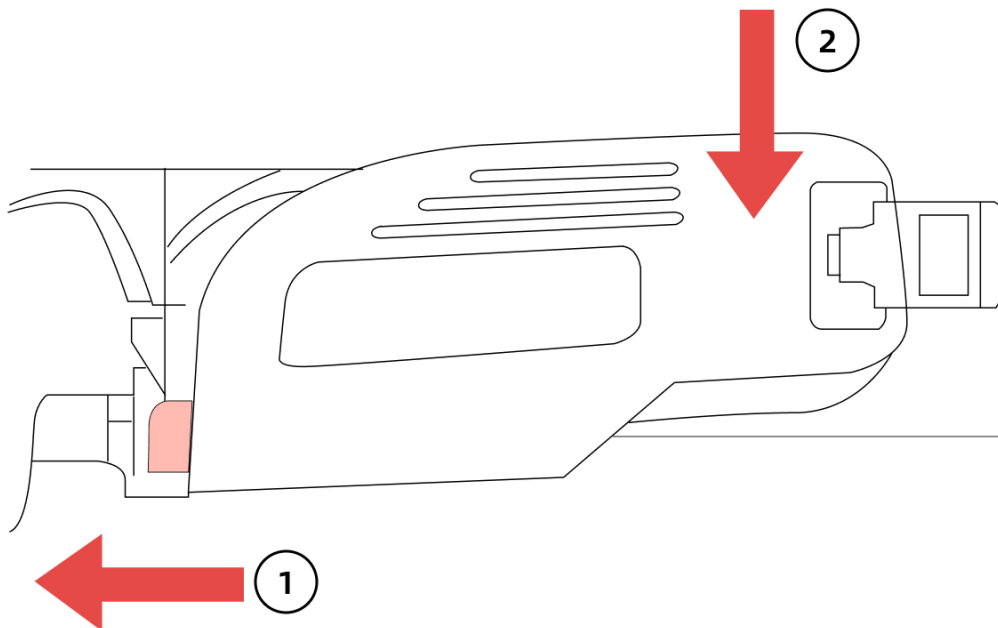

# Wind the Bobbin Thread

1 Turn on the machine.

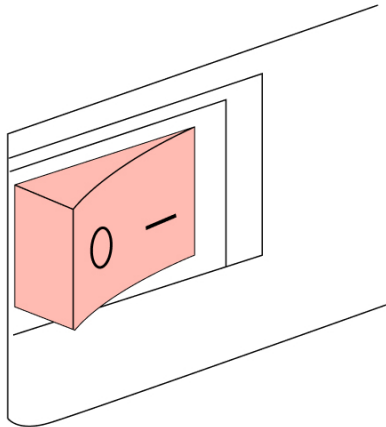

2 Place the bobbin on the bobbin winder shaft so that the spring on the shaft fits into the notch in the bobbin. Press down on the bobbin until it snaps into place.

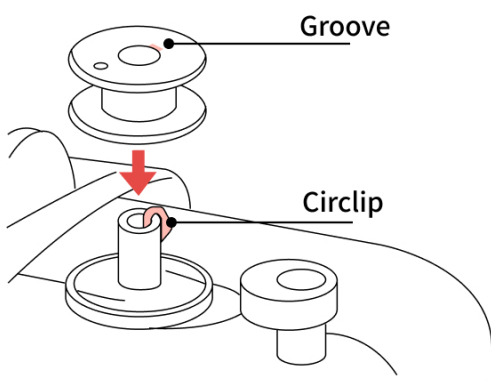

3 Lift up the spool pin.

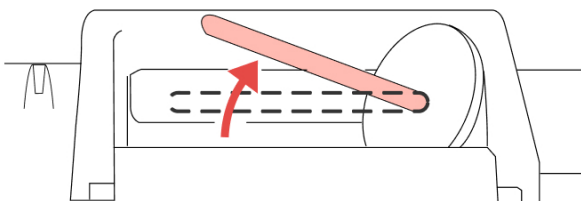

4 Place the spool of thread for bobbin onto the spool pin, make the thread unwind to the front.

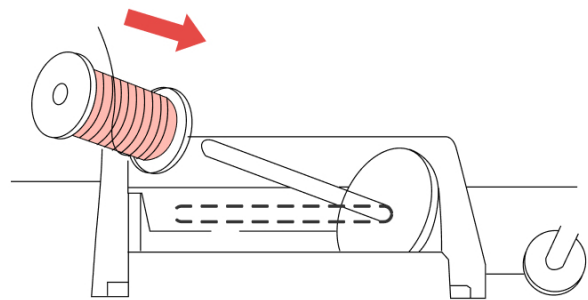

5 Install the spool cap to the spool pin.

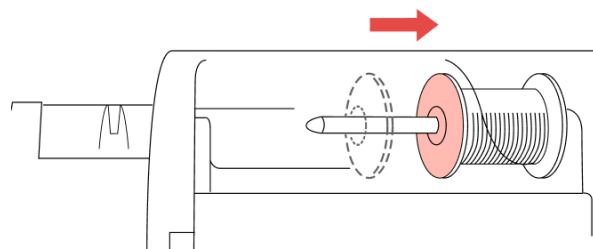

## ⚠ Tips:

Three spool cap sizes are available (large, medium, small) allowing you to choose a spool cap that best fits the size of the spool being used. If the spool cap is too small for the spool being used, the thread may get caught on the slit in the spool, causing the thread breaking and needle breaking.

# Wind the Bobbin Thread

- 6** Pull the thread from the spool with two hands and pass the thread under the hook of thread guide.

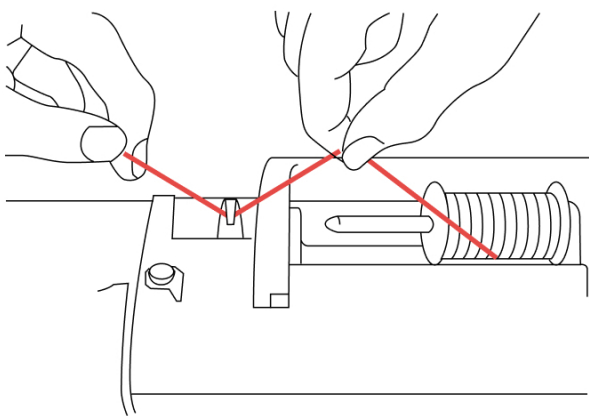

- 7** Pass the thread through the guide cover.

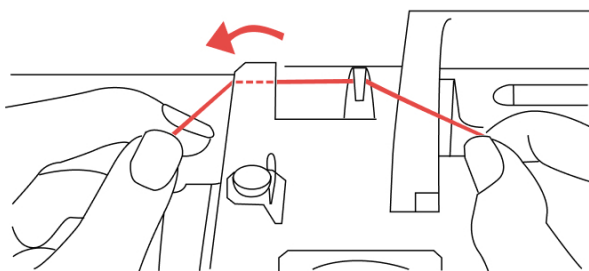

- 8** Pass the thread through the pretension disk in the direction as shown in the figure, make sure that the thread passes under the pretension disk.

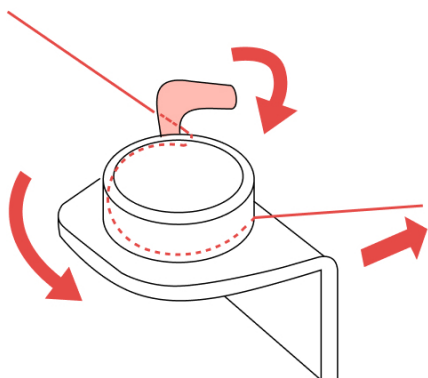

- 9** Wind the end of the thread clockwise around the bobbin 5-6 times.

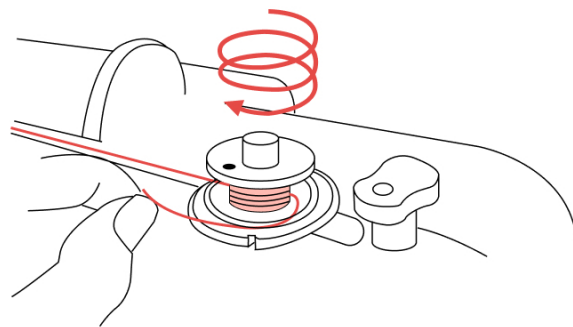

- 10** Pass the end of the thread through the guide slit in the bobbin winder seat, then pull the thread to the right and cut it with the built-in cutter.

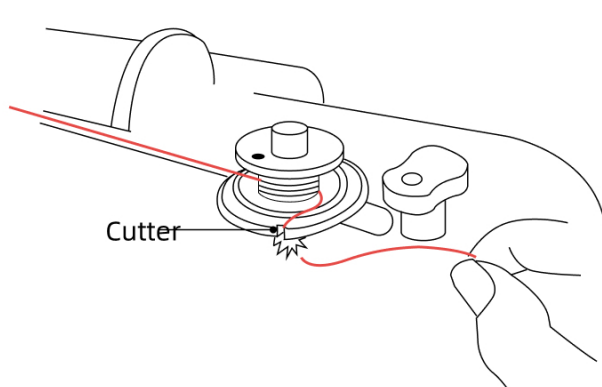

- 11** Slide the bobbin winder to the right.

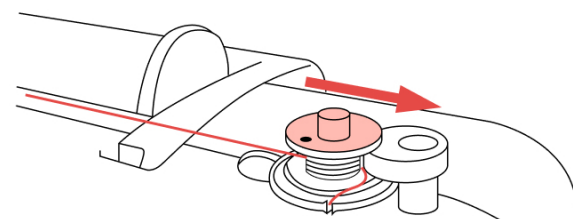

# Wind the Bobbin Thread

- 12 Press the Start button, and the machine starts to wind automatically.

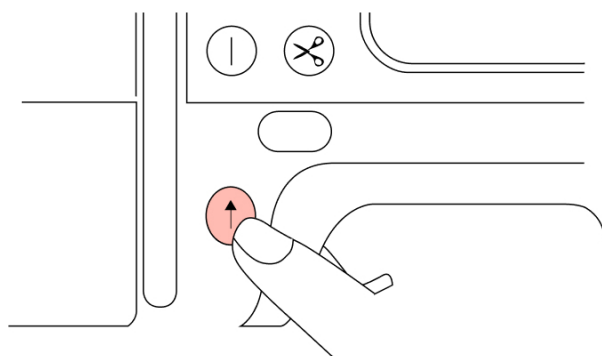

- 13 When the bobbin winding is finished, cut the thread with scissors, slide the bobbin winder to the left, and then remove the bobbin from the shaft.

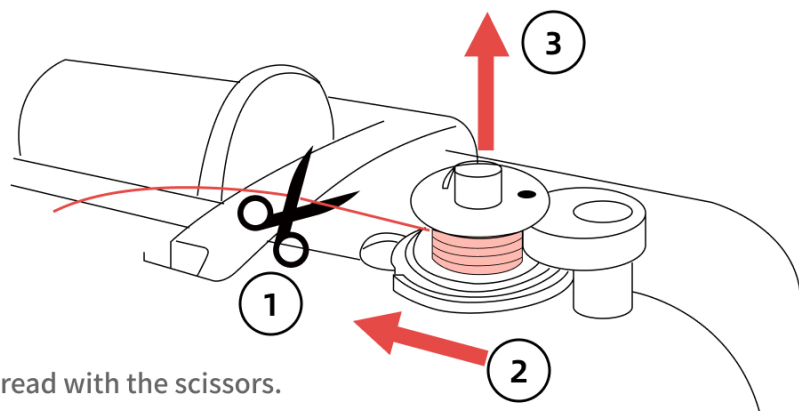

- 1 Cut the thread with the scissors.
- 2 Slide the bobbin winder to the left.
- 3 Remove the bobbin from the shaft.

## ⚠ Tips:

Please use the bobbin included with the machine to wind the thread, if you want to buy it, please choose the same size bobbin in the picture below. Otherwise, the machine will not work normally.

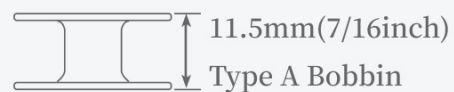

# How to Replace The Needle

- 1 Press the "Needle position" button on the machine to raise the needle to its highest position.

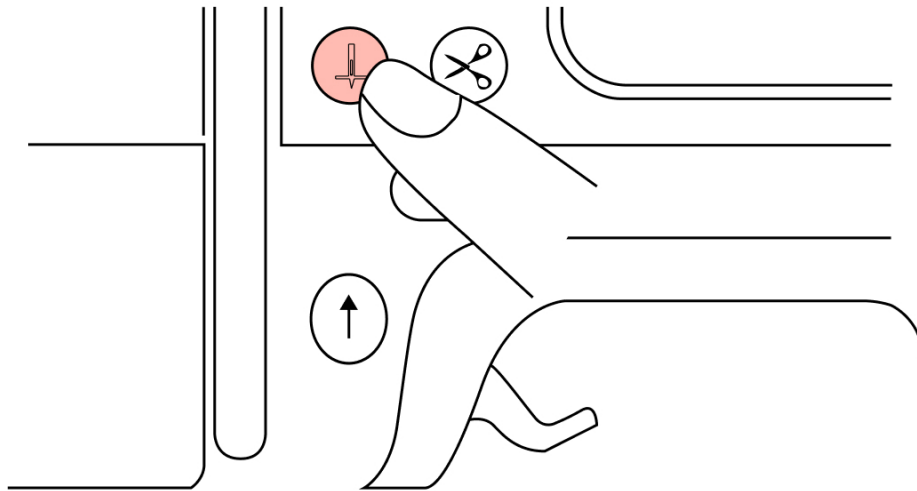

- 2 Turn off the machine. Use a screwdriver to turn the screw counterclockwise, then loosen the screw and remove the needle that needs to be replaced.

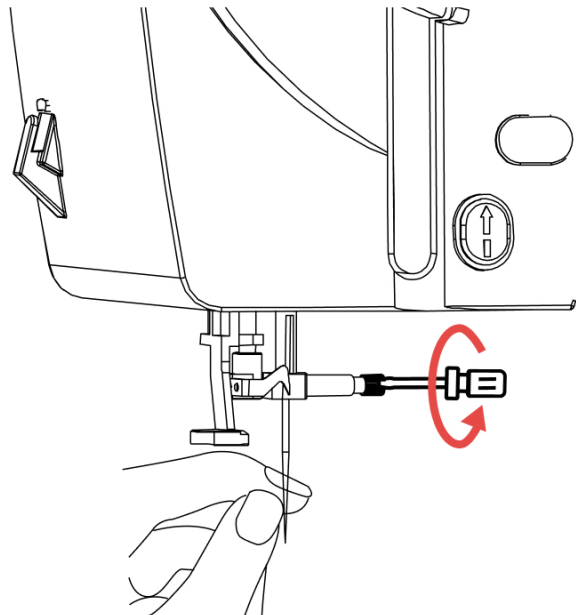

## ⚠ Tips:

Before replacing the needle, please turn off the machine and cover the hole on the needle plate with a cloth or paper to prevent the needle from falling into the machine.

# How to Replace The Needle

- 3 With the flat side of the needle towards the back, insert the needle until it touches the needle stopper. Tighten the needle clamp screw with a screwdriver.

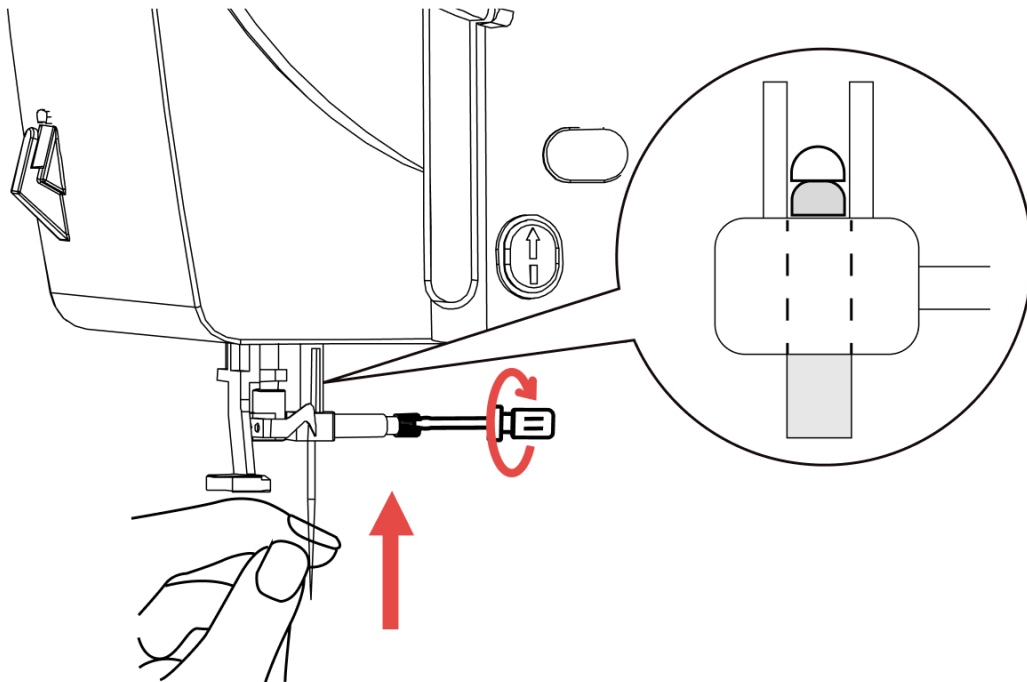

## ⚠ Tips:

1. When installing the embroidery needle, ensure that the flat side of the needle shank is facing the rear (toward the machine).
2. If the needle is not fully inserted or the clamp screw is loose, it may cause the needle to break or damage the machine.

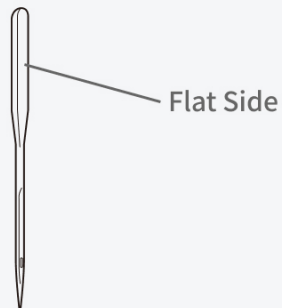

# Install the Embroidery Unit

## Install the Embroidery Unit

1. Turn off the machine.

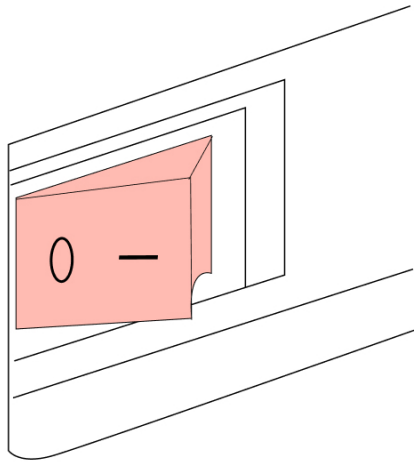

2. Gently slide the embroidery unit onto the machine arm until it clicks and stops.

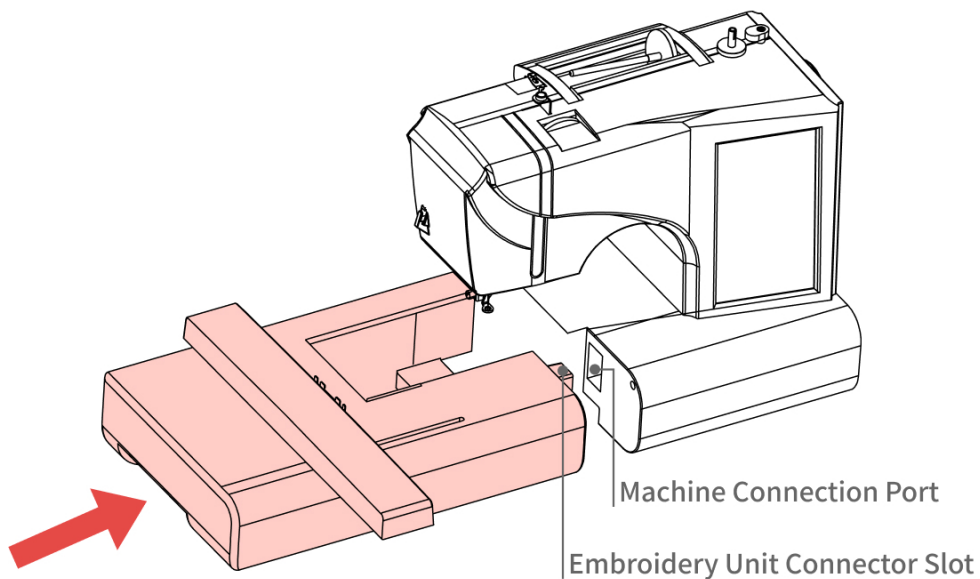

### Tips:

Please make sure the machine is off before attaching the embroidery unit, otherwise the machine will be damaged.

# Remove the Embroidery Unit

## Remove the Embroidery Unit

1. Turn off the machine.

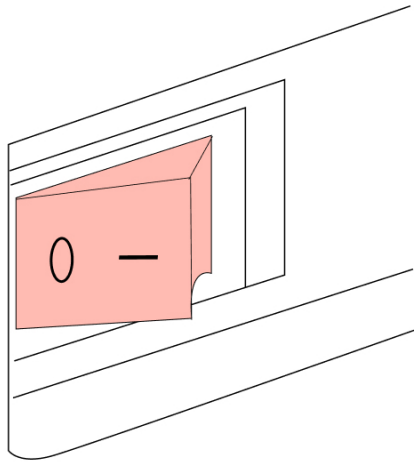

2. Hold the release button on the bottom of the embroidery unit, and pull the embroidery unit horizontally until it is completely detached from the machine.

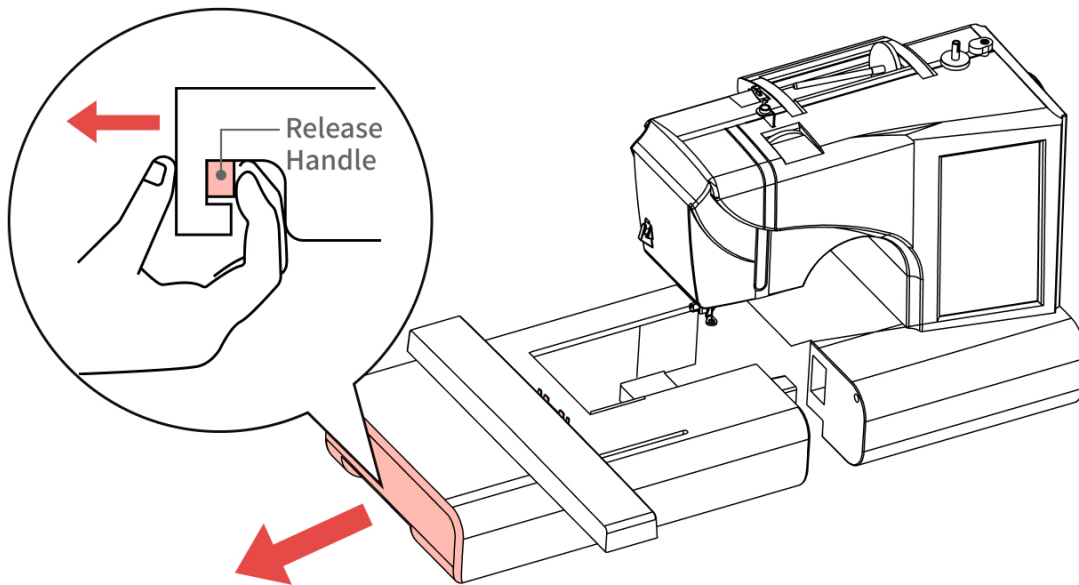

### ⚠ Tips:

Please make sure the machine is off before attaching the embroidery unit, otherwise the machine will be damaged.

# Attach the Frame and Fabric

- 1 Loosen the embroidery frame adjustment screw and remove the inner frame.

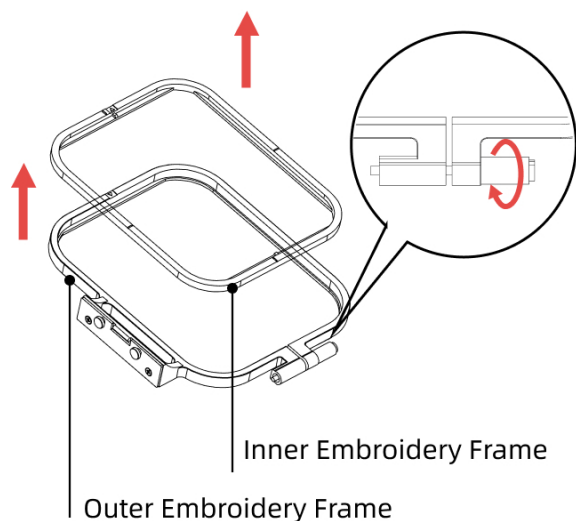

- 2 Place the stabilizer on top of the outer embroidery frame, and lay the fabric face up on top of the stabilizer.

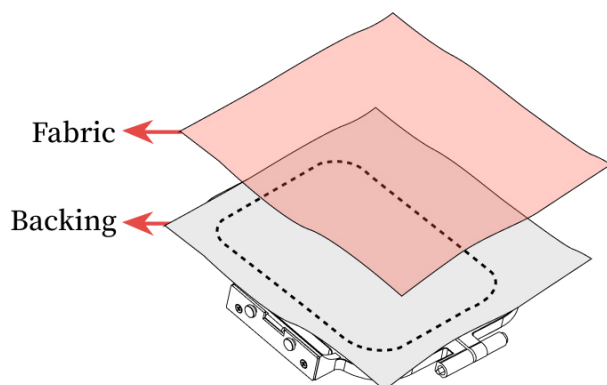

### ⚠ Tips:

The stabilizer and fabric should be larger than the area of the embroidery frame to ensure the fabric can be fixed on the frame and avoid misalignment of embroidery.

- 3 Press the inner frame in from the top of the fabric and make sure the inner frame is aligned with the outer frame.

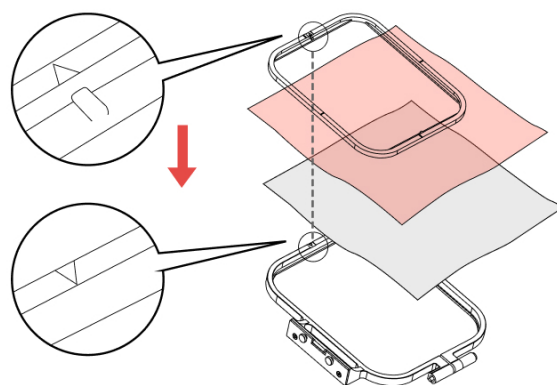

### ⚠ Tips:

Line up  $\triangle$  on the inner frame and  $\nabla$  on outer.

- 4 Gently stretch the edges and corners of the fabric to remove the wrinkle.

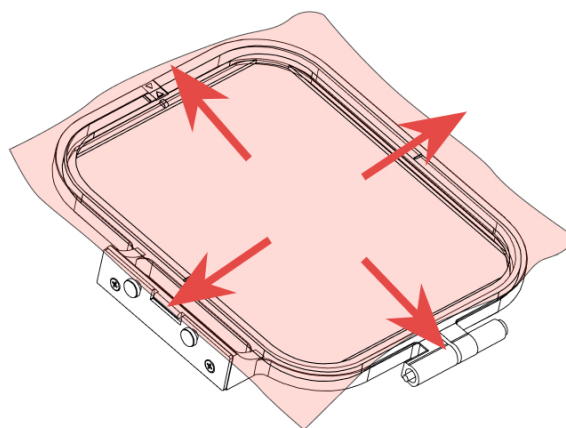

# Attach the Frame and Fabric

- 5 Tighten the frame adjustment screw to remove the slack in the fabric.

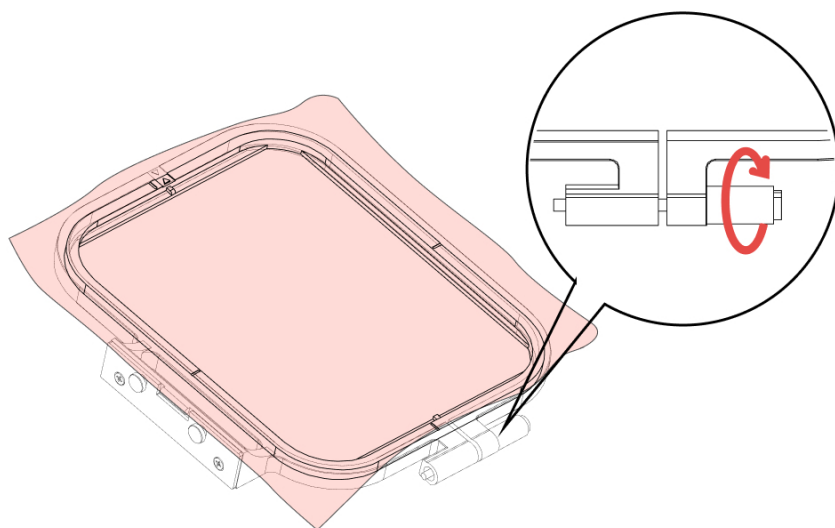

- 6 Raise the presser foot lever, attach the frame on the rail, press the frame down to insert the frame guide into the embroidery carriage frame holder from the top.

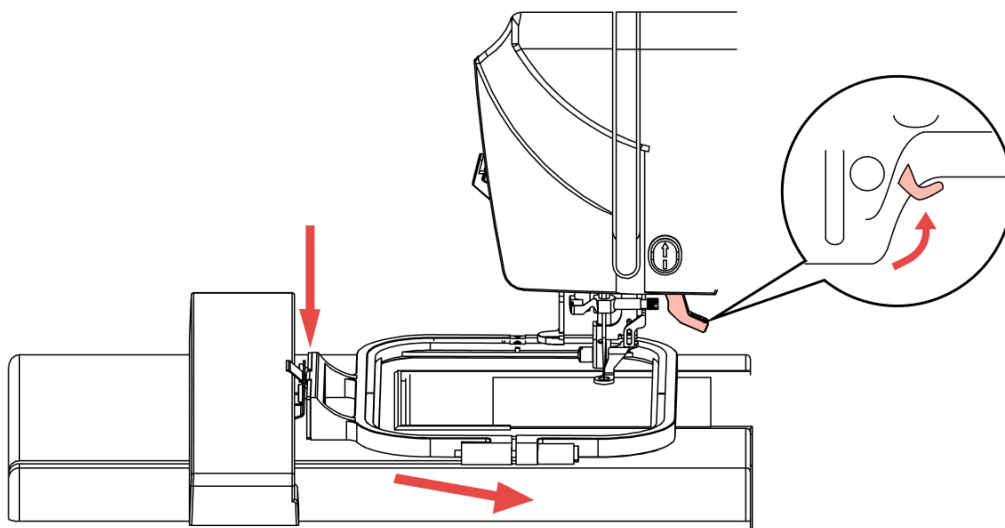

**⚠ Tips:**

If the height of the presser foot is not enough to attach the frame, you can continue to raise the presser foot lever to make it higher, so as to ensure the smooth installation of the embroidery frame.

# Detach the Frame

1 Raise the presser foot lever.

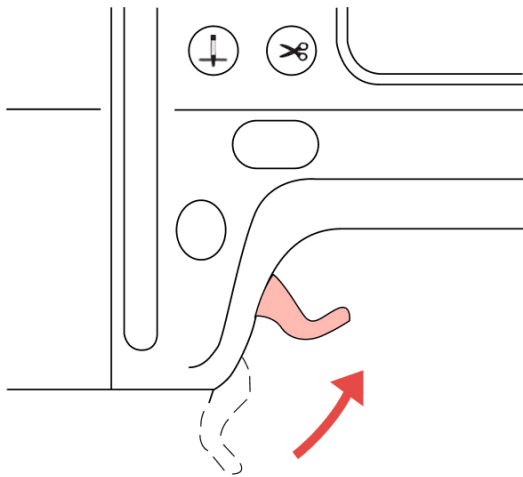

2 Press the part of the embroidery frame holder to the left side as shown in the figure below.

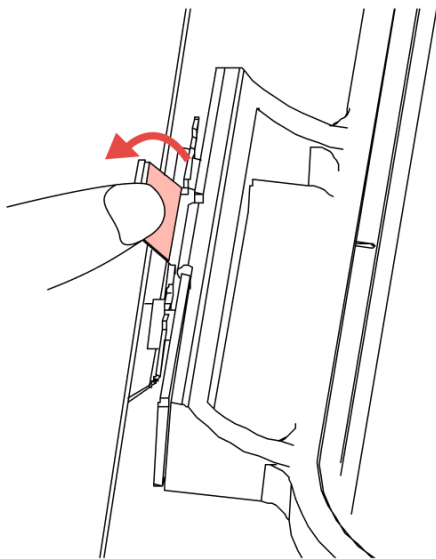

3 Raise the embroidery frame, make it separate from the embroidery frame holder and remove the frame.

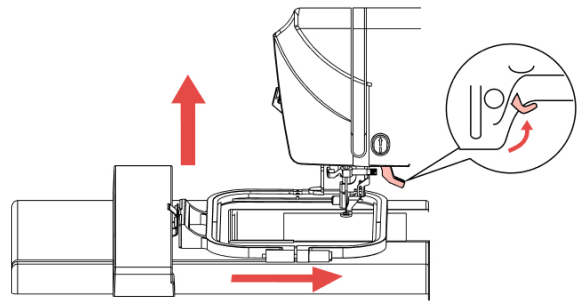

## ⚠ Tips:

If the height of the presser foot is not enough to remove the frame, you can continue to raise the presser foot lever to make it higher, so as to ensure the smooth remove of the embroidery frame.

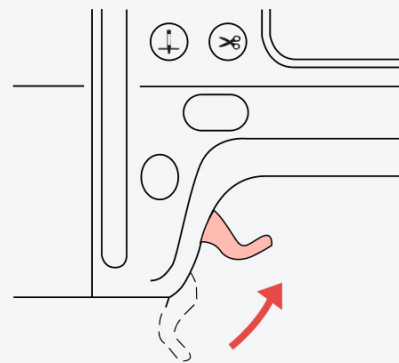

# How to Adjust the Upper Thread Tension

When embroidering, the correct standard of thread tension should be:

- 1.The top thread is slightly visible on the back of the fabric.
- 2.The front of the fabric can not see the bottom thread at all and there is no floating thread on the surface.



## Correct Tension Display Diagram

Fabric front

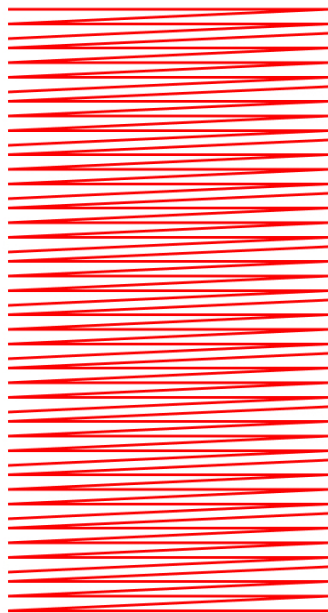

Fabric back

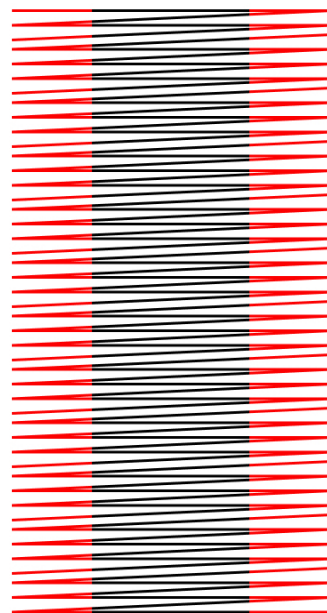

● Red is upper thread

● Black is bottom thread

### ⚠ Tips:

If the upper thread tension is not set correctly, it will lead to poor embroidery effect, thread jamming, thread breakage and needle breakage.

# How to Adjust the Upper Thread Tension



## Incorrect Tension Display Diagram

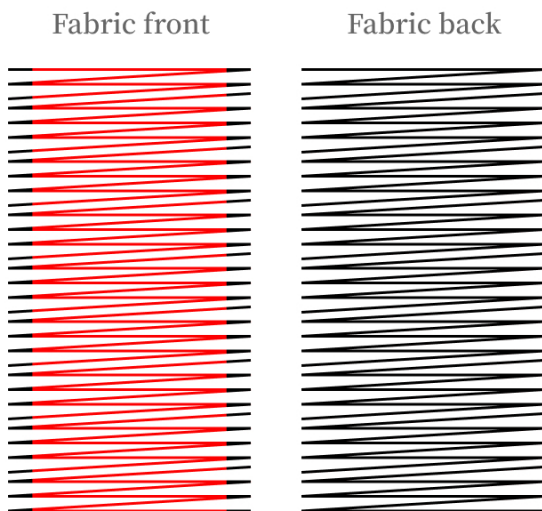

### Upper thread too tight

If the tension of the upper thread is too tight, the bottom thread will be visible from the front of the fabric.

#### Adjustment Steps:

Turn the tension adjustment dial to the left to decrease the value to decrease the tension.

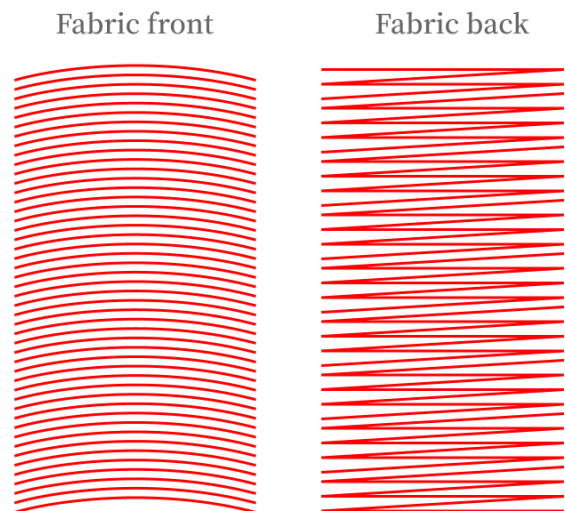
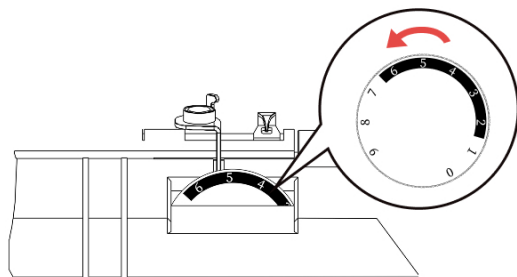

### Upper thread too loose

If the tension of the upper thread is too loose, the floating thread can be seen from the front of the fabric, and the bottom thread can hardly be seen from the reverse side.

#### Adjustment Steps:

Turn the tension adjustment dial to the right to increase the value to increase the tension.

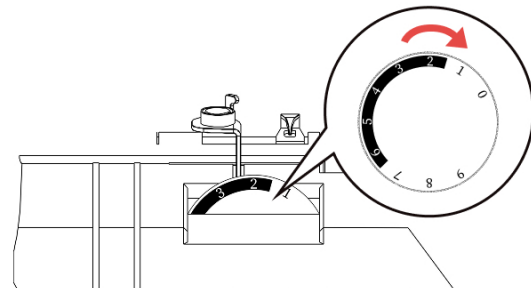

#### ⚠ Tips:



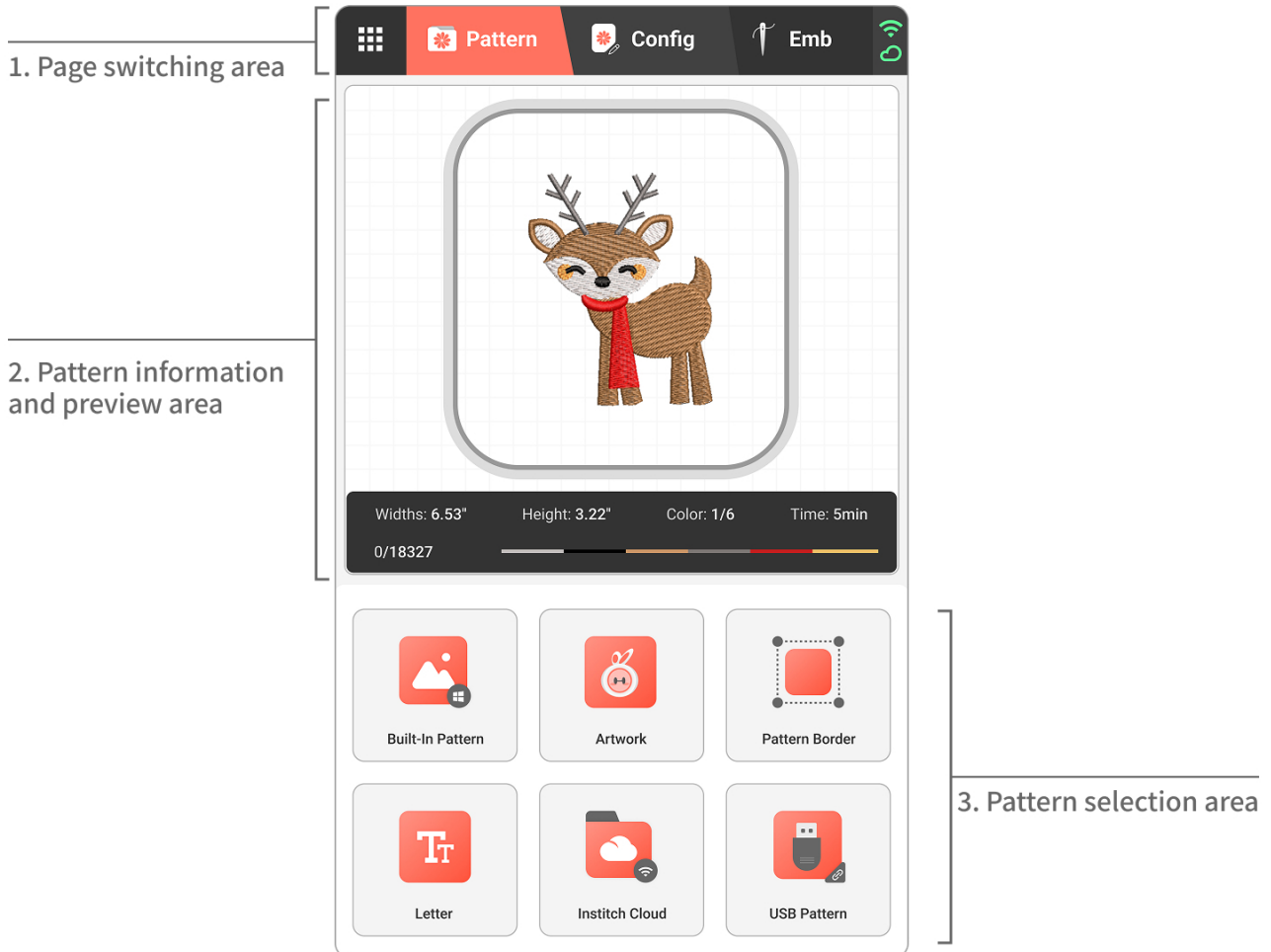

The larger the value corresponding to the dial, the greater the upper thread tension. Please adjust the appropriate tension according to different fabrics and designs. The general fabric tension dial should be between 3-5.

# Pattern Selection Page Introduction



34

## 1. Page switching area

Contents	Description
	Set page.
	Pattern selection page.
	Pattern editing page. You cannot enter this page without selecting a pattern.
	Embroidery status page. You cannot enter this page without selecting a pattern.

# Pattern Selection Page Introduction

## Contents

## Description



### Wi-Fi Signal Status & Pattern Sync Switch

- Strong Wi-Fi signal; pattern sync is enabled
- Good Wi-Fi signal; pattern sync is enabled
- Weak Wi-Fi signal; pattern sync is enabled
- Strong Wi-Fi signal; pattern sync is disabled

## 2. Pattern information and preview area

### Contents

### Description



Display the position of the pattern in the selection frame.

Displays the actual position of the pattern within the current embroidery frame.



If the pattern exceeds the frame area, the preview zone will show a red gradient as a warning, prompting the user to make adjustments.

Widths: 6.53"   Height: 3.22"   Color: 1/6   Time: 5min  
0/18327

Displays basic pattern information (such as size, stitch count, etc.) and the embroidery sequence.

## 3. Pattern Selection Area

### Contents

### Description

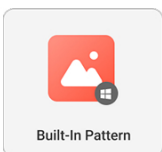

Built-in Patterns

# Pattern Selection Page Introduction

## Contents

## Description

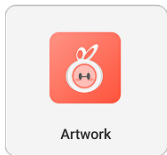

Built-in Poolin IP Characters

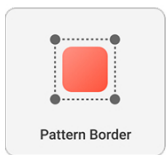

Built-in Lace Patterns

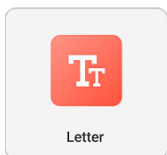

Custom Letter Embroidery

Use the built-in keyboard to enter text and generate embroidery patterns instantly.



Institch Cloud Folder

Once the device is bound and transmission is complete, patterns in this folder will automatically sync to the Institch Cloud Platform.

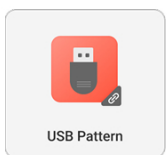

USB Patterns

1. After inserting a USB drive, the system will automatically detect compatible pattern files. You can select and start embroidering immediately—no download required.
2. Tap the “Select” button to batch select multiple patterns and import them to the device.

# Letter Embroidery



## Description of Functions

### Contents

### Description



#### Font Selection Panel

1. Language: 8 built-in artistic fonts
2. Characters: A-Z, a-z, numbers, symbols, Latin letters



#### Adjust Letter Size

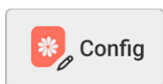

#### Letter Edit Shortcut

Tap to enter editing for style adjustments.

# Institch Cloud Folder

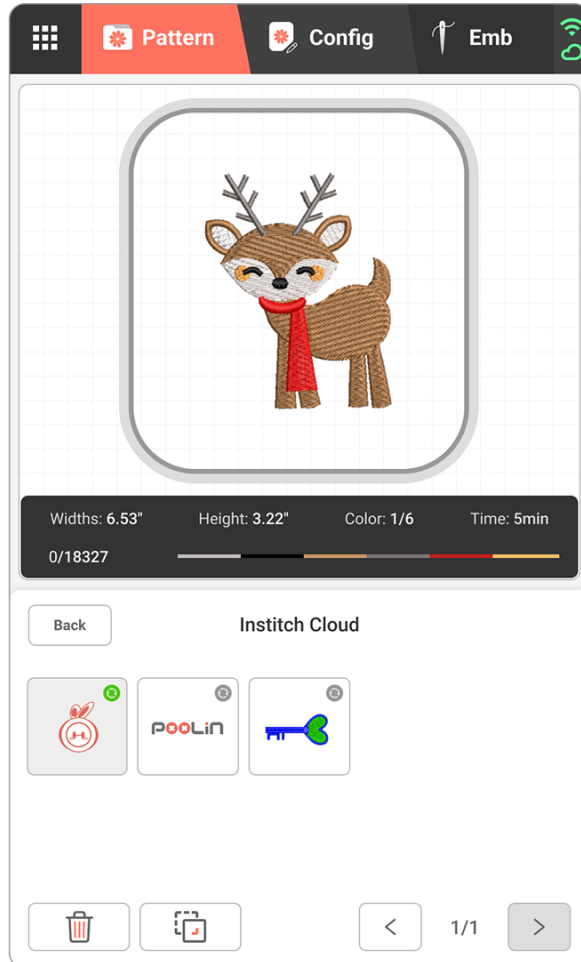

38

## Description of Functions

### Contents

### Description



Delete Button  
Tap to select and delete multiple patterns.



Combine Button  
Up to 8 patterns can be combined.



Pattern List Pagination



Cloud Sync Status  
Green: Synced to cloud  
Gray: Not synced

# Import Patterns from USB to Machine

1. If a “USB not detected” message appears during import, please unplug and reinsert the USB or try a different USB device, then re-import.
2. The USB storage capacity must be less than 64GB and formatted as FAT32.
3. Do not remove the USB before the import is complete to avoid data loss.
4. This machine supports pattern files in DST/DSB formats. Other formats need to be converted using design software.

1 Insert the USB drive.

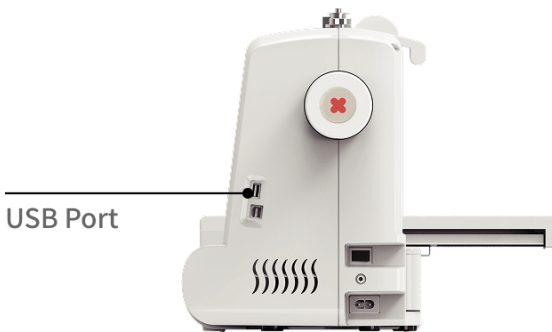

2 Tap USB Pattern.

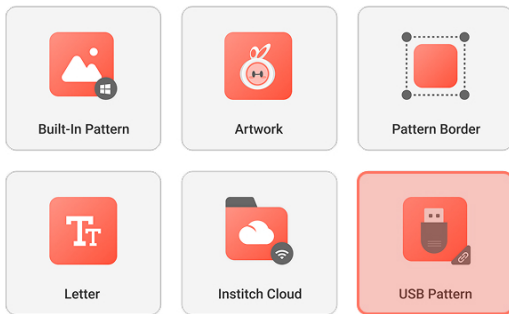

3 Tap the Select button.

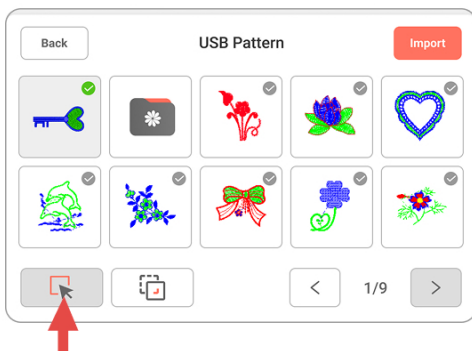

4 Choose the patterns you want to import, then tap Import.

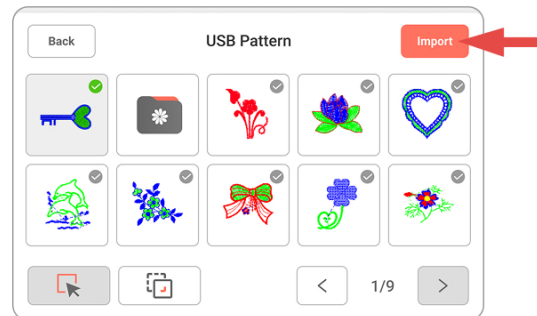

5 Tap the Back button, then tap Institch Cloud.

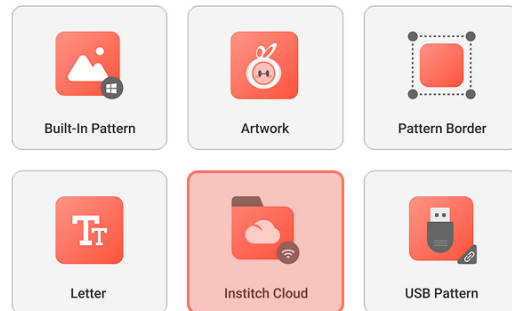

6 Imported patterns will appear in the Institch Cloud folder.

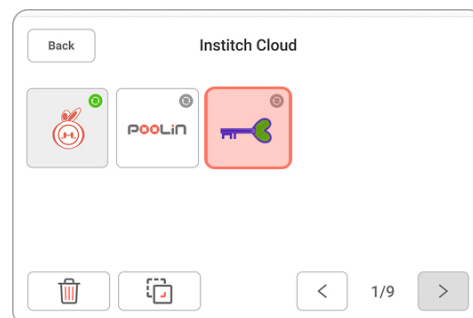

# Direct Embroidery from Patterns on USB

1. The USB storage capacity must be less than 64GB and formatted as FAT32.
2. This machine supports pattern files in DST/DSB formats. Other formats need to be converted using design software.

1 Insert the USB drive.

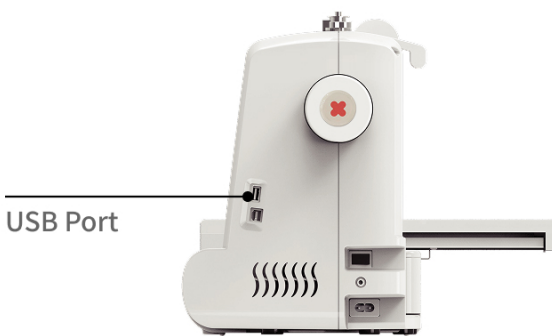

2 Tap USB Pattern.

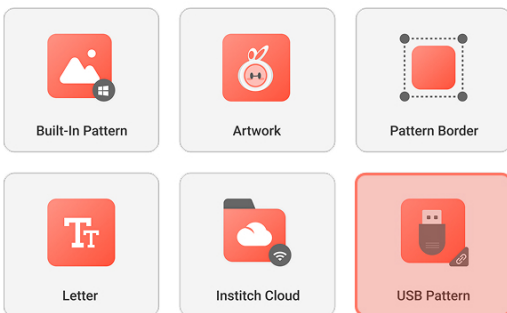

3 Select the pattern(s) you want to embroider.

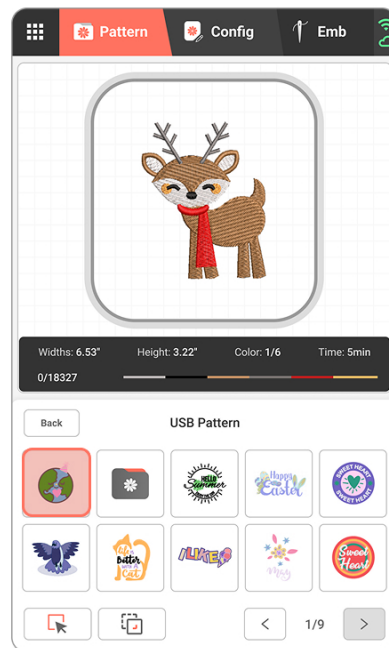

4 Tap the Back button.

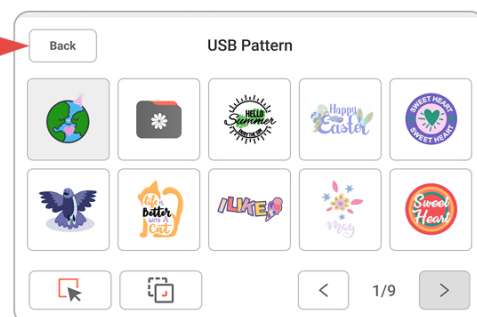

# Combine Multiple Patterns for Emb

- 1 Tap the Multi-Select button, then choose the patterns to combine.

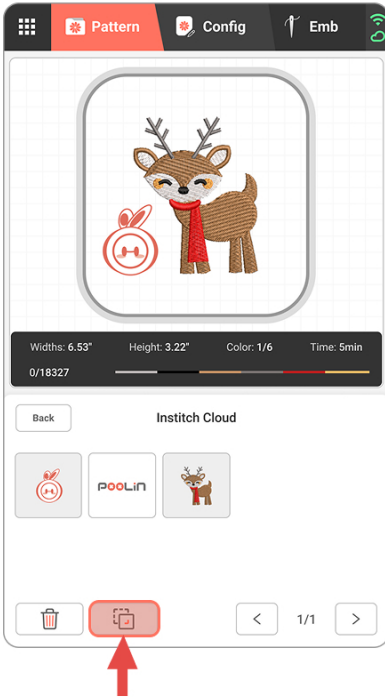

## ⚠️ Tips:

1. You can combine up to 8 patterns.
2. Supported sources include built-in patterns, Institch Cloud, letter patterns, and custom USB-imported patterns.

- 2 After selection, tap the Edit button.

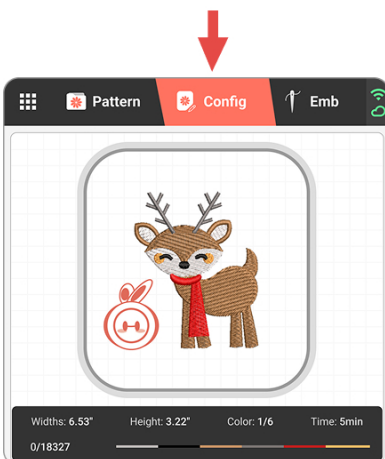

- 3 Use the left/right arrow keys to switch between patterns, edit them individually, or switch to Edit All mode.

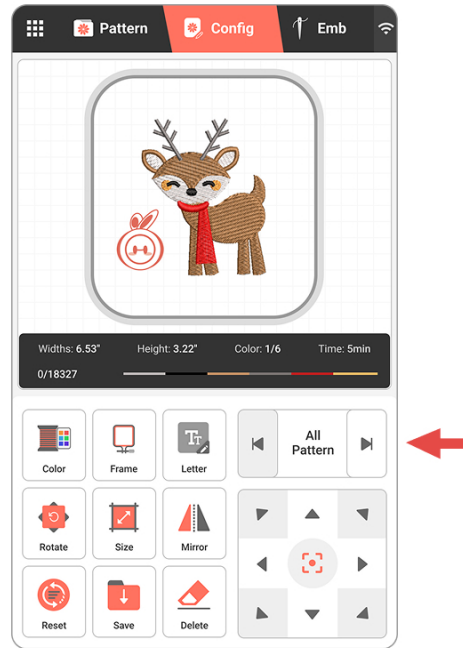

- 4 To save the combined pattern, tap the Save button. It will be stored in the Institch Cloud folder.

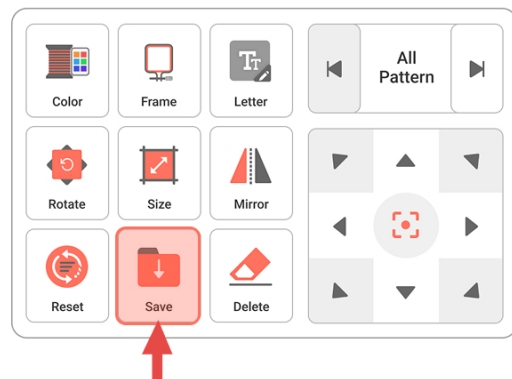

# Pattern Editing Page Introduction

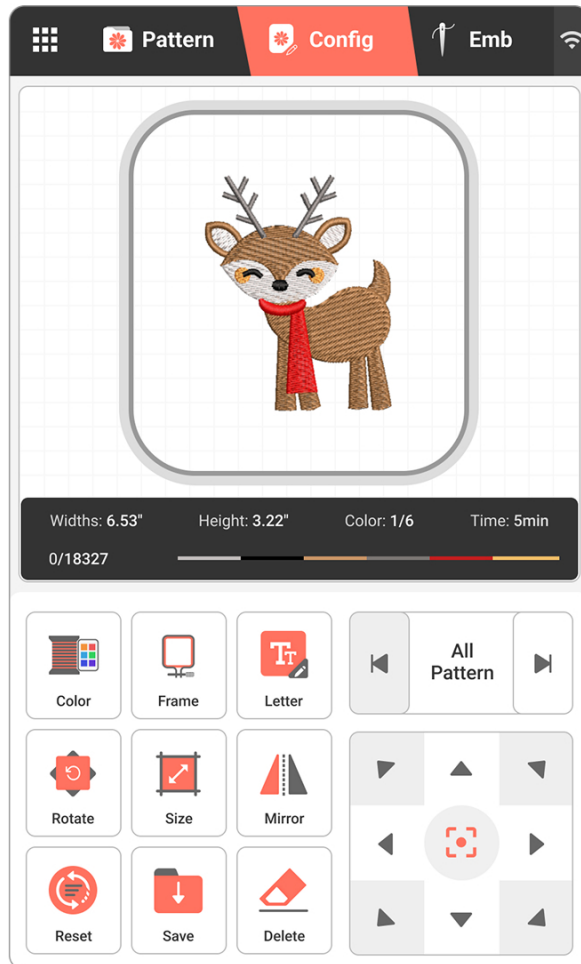

Pattern Editing Panel

## Pattern Editing Panel

### Contents

### Description



Color

Color setting page.

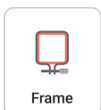

Frame



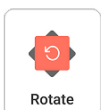





Embroidery frame selecting page.

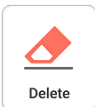

Rotate

Pattern rotating page.

# Pattern Editing Page Introduction

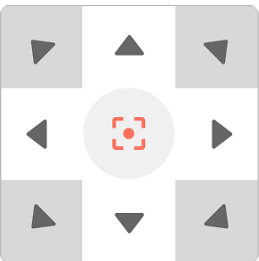
Contents	Description	
 Size	Pattern zoom page.	
 Mirror	Mirror Pattern Page	
 Reset	Reset Edited Pattern After tapping the Reset button, the selected pattern will be cleared.	
 Save	Save Edited Pattern After tapping the Save button, a new pattern will be generated in Institch Cloud.	
 Delete	Delete Edited Pattern After tapping the Delete button, the currently selected pattern will be deleted. In combination mode, use the left and right switch keys to select the pattern to delete.	
 Letter	 Letter	Edit Letter Pattern This button is only available when a letter pattern is selected.
	Select Combined Pattern <ol style="list-style-type: none"> <li>1. Use the left/right arrow buttons to switch between group selection and single selection.</li> <li>2. This function is disabled when only one pattern is selected.</li> </ol>	
	Move Pattern Within Frame Center: Move the pattern to the center of the display. Top Left: Move the pattern to the top-left of the display. Top Right: Move the pattern to the top-right of the display. Bottom Left: Move the pattern to the bottom-left of the display. Bottom Right: Move the pattern to the bottom-right of the display.	

# Set Pattern Colors

1 Select a pattern and tap Config.



Note: You must select at least one pattern before entering the editing page.

2 Tap Color.

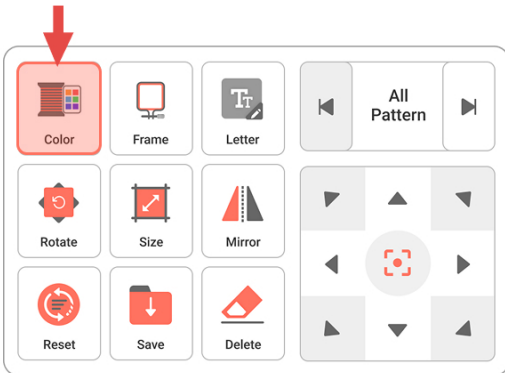

3 Choose a layer, then tap the color block on the right to fill it. The color will update in real time in the Pattern Info area.

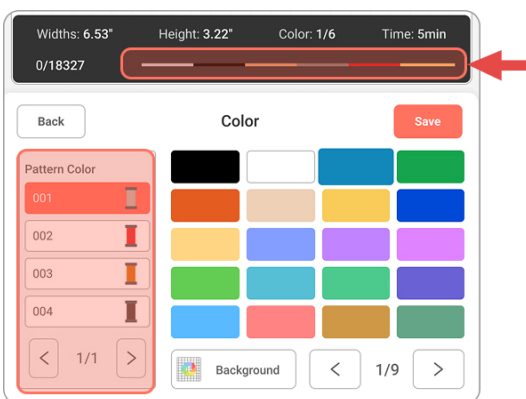

4 After adjusting, tap Save to apply the changes.

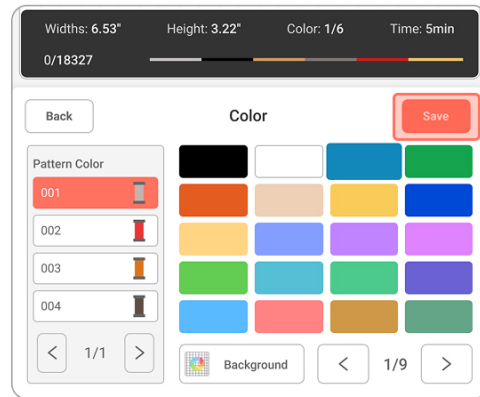

## ! Tips:

If you're not satisfied with the selected colors, tap Back to discard changes.

# Set Preview Background Color

1 Select a pattern and tap Config.



Note: You must select at least one pattern before entering the editing page.

2 Tap Color.

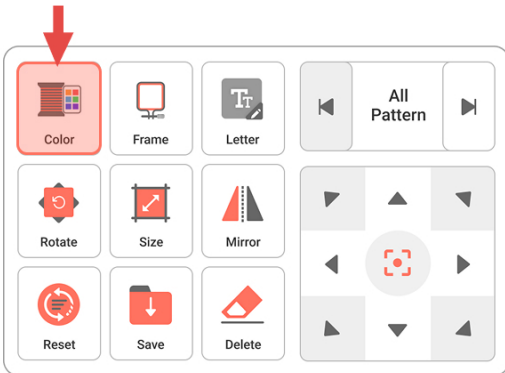

3 Tap Background, then tap the color block on the right to fill it. The preview area will update in real time.

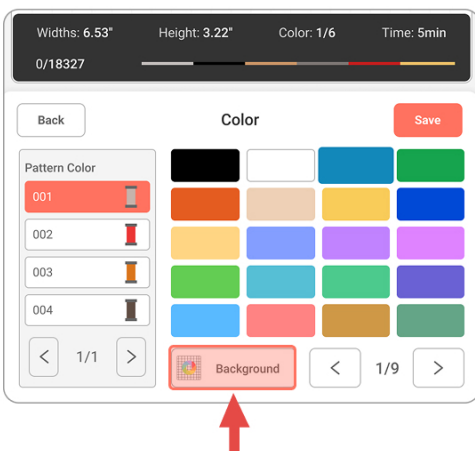

4 After adjusting, tap Save to apply the changes.

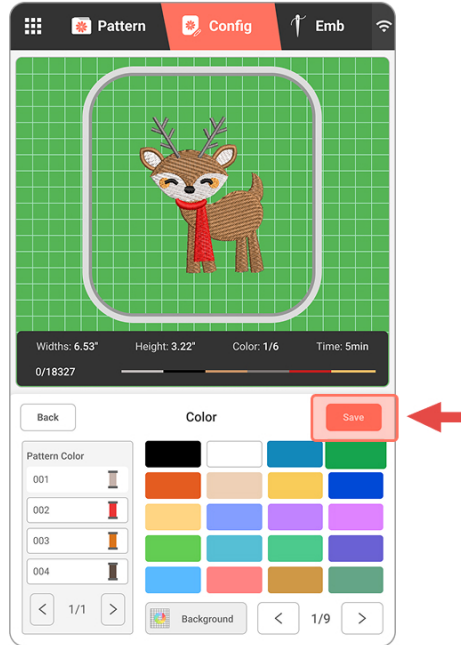

## ⚠ Tips:

If you're not satisfied with the selected background color, tap Back to discard changes.

# Select Embroidery Frame

Note: The attached embroidery frame must match the corresponding embroidery frame displayed on the screen, otherwise the frame collision may occur, resulting in damage to the machine.

- 1 Select a pattern and tap Config.



Note: You must select at least one pattern before entering the editing page.

- 2 Tap Frame.

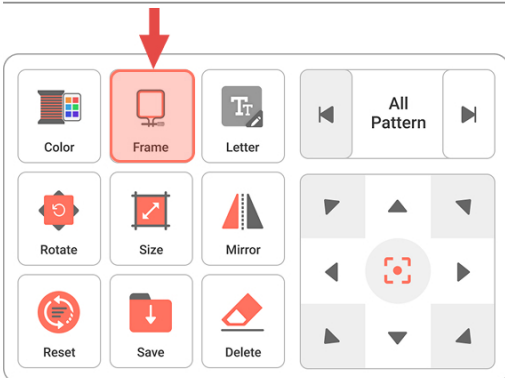

- 3 Choose the Appropriate Embroidery Frame

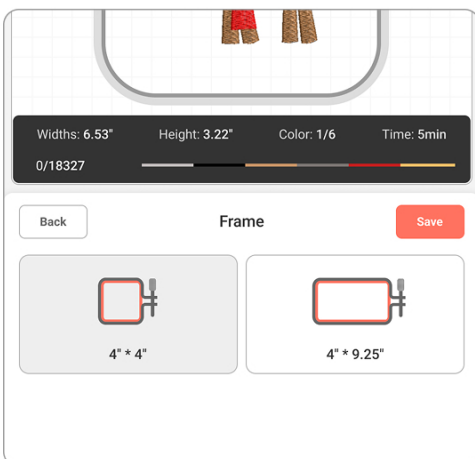

- 4 After adjusting, tap Save to apply the changes.

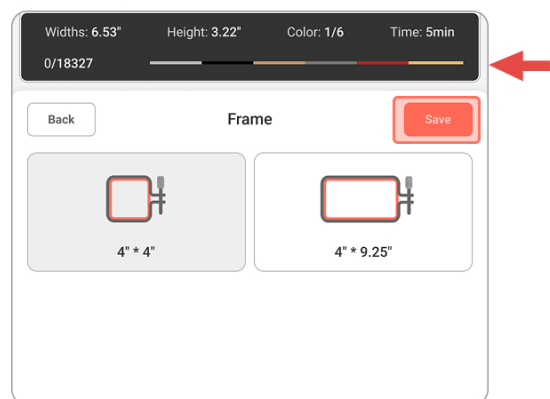

## ! Tips:

When selecting a frame, the machine will automatically move to its origin position. Make sure there are no objects nearby to avoid collisions or damage.

## ! Tips:

Ensure the embroidery area of the selected frame is larger than the pattern size.

# Letter Editing



## Description of Functions

### Contents

### Description

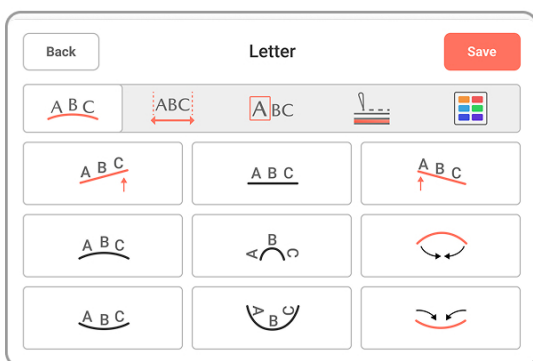

We offer commonly used text distortion effects to help you quickly create fun and unique styles:

1. Arch Up: Text curves upward like a rainbow.
2. Arch Down: Text curves downward, ideal for bottom arcs.
3. Italic: Slants the text for a dynamic look.

# Letter Editing

## Contents

## Description

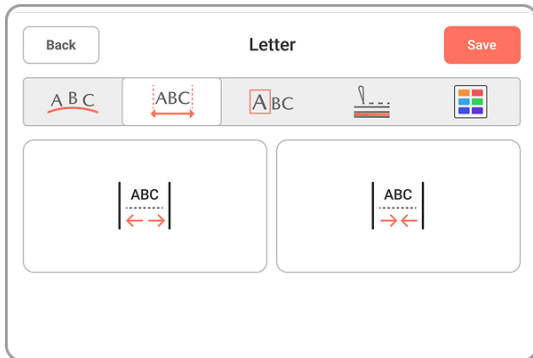

Adjust the spacing between letters freely.

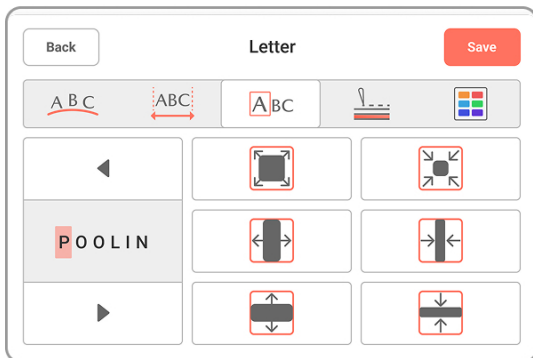

Select a letter and adjust its size independently.

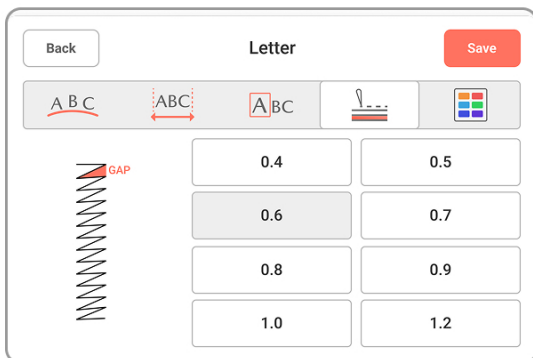

Freely adjust the distance between characters (range: 0.4–1.2). The smaller the number = the denser the stitches; The larger the number = the sparser the stitches.

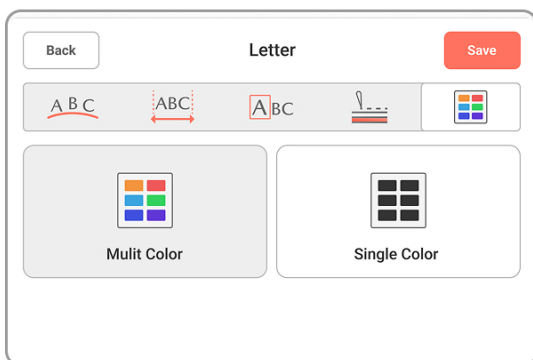

Color Mode Switch:

Single Color: All letters use the same color.

Multi-Color: Assign different colors to each letter.

# Rotate Pattern

Note: Only edits within the frame range can be saved successfully, please pay attention to the border line of the frame in the preview area.

1 Select a pattern and tap Config.



Note: You must select at least one pattern before entering the editing page.

2 Tap Rotate.

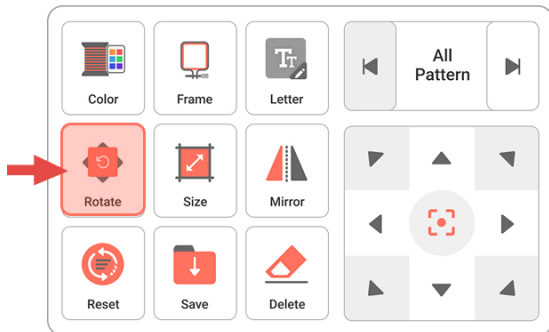

3 Rotate the pattern.

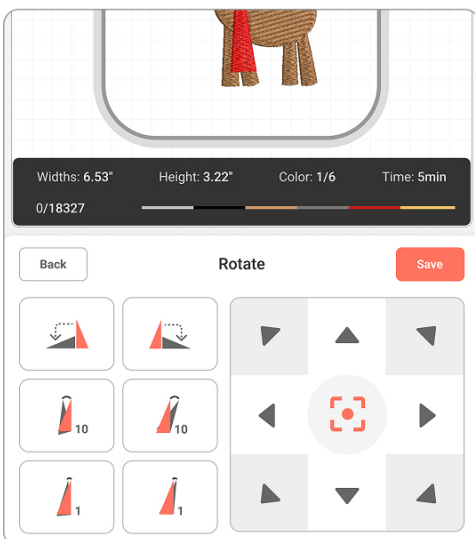

Rotate the pattern counterclockwise 90 degrees.



Rotate the pattern clockwise 90 degrees.



Rotate the pattern counterclockwise 10 degrees.



Rotate the pattern clockwise 10 degrees.



Rotate the pattern counterclockwise 1 degree.



Rotate the pattern clockwise 1 degree.

4

After adjusting, tap Save to apply the changes.

# Scale Pattern

Note: Only edits within the frame range can be saved successfully, please pay attention to the border line of the frame in the preview area.

1 Select a pattern and tap Config.



Note: You must select at least one pattern before entering the editing page.

2 Tap Size.

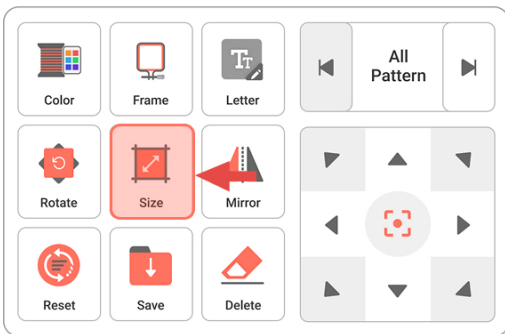

3 Adjusting Pattern Size.

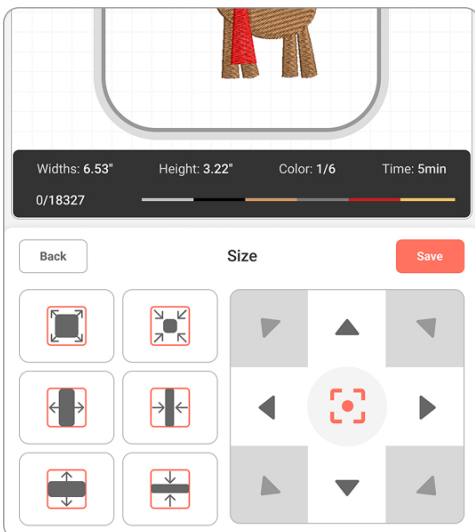

The pattern is enlarged along the center point.



The pattern is shrinks along the center point.



The pattern is enlarged along the X direction.



The pattern shrinks along the X direction.



The pattern is enlarged along the Y direction.



The pattern shrinks along the Y direction.

4 After adjusting, tap Save to apply the changes.

# Mirror Pattern

Note: Only edits within the frame range can be saved successfully, please pay attention to the border line of the frame in the preview area.

1 Select a pattern and tap Config.



Note: You must select at least one pattern before entering the editing page.

2 Tap Mirror.

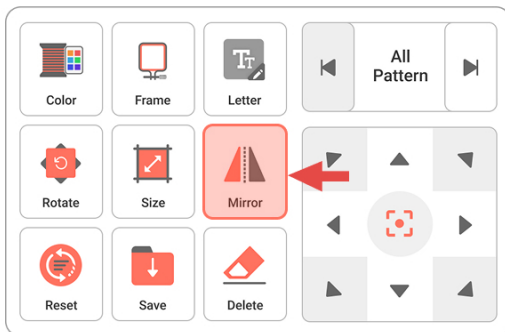

3 Mirror the pattern.

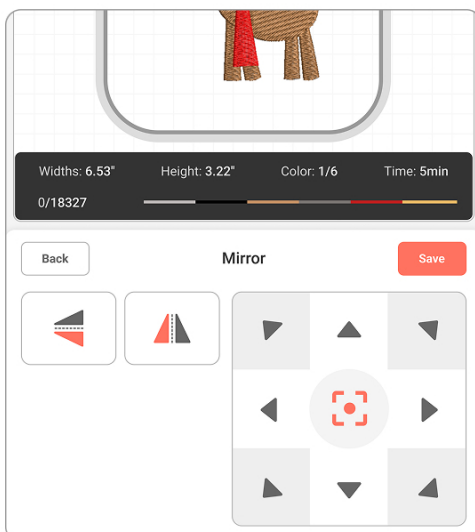

Flip Vertically



Flip Horizontally

4 After adjusting, tap Save to apply the changes.

# Reset Edited Pattern

Note: Only edits within the frame range can be saved successfully, please pay attention to the border line of the frame in the preview area.

1 Click the Reset button.

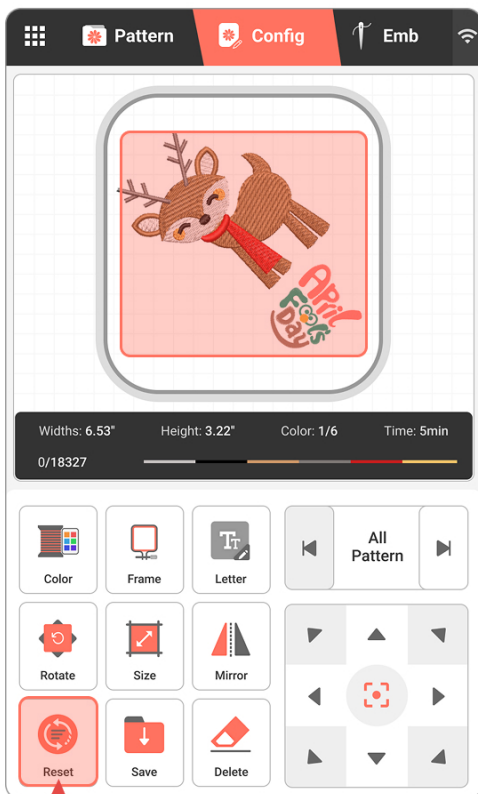

2 The pattern will be restored to its initial state.

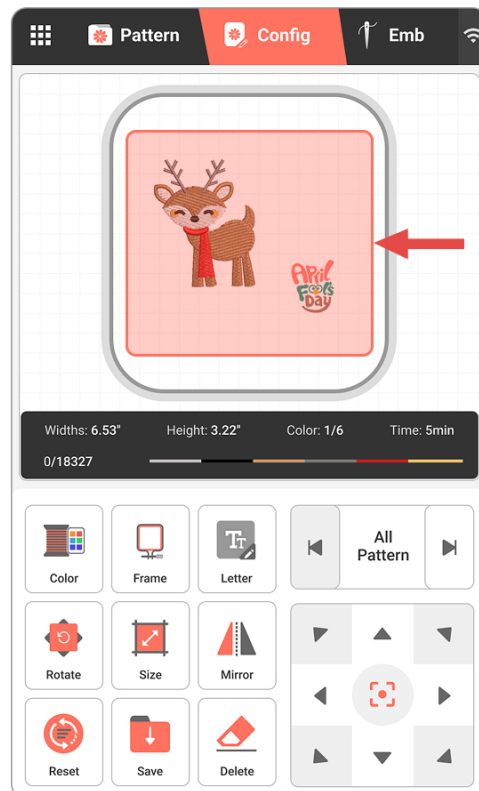

# Save Edited Pattern

Note: Only edits within the frame range can be saved successfully, please pay attention to the border line of the frame in the preview area.

- 1 Tap the Save button to store the current pattern.

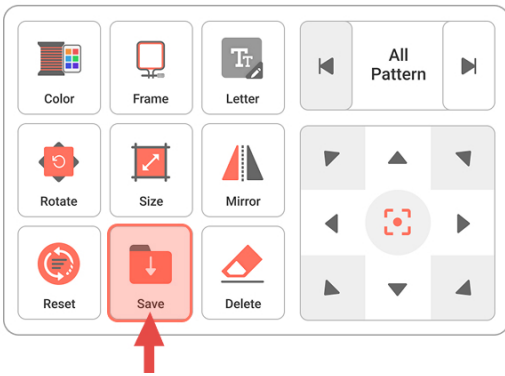

- 2 Tap the Pattern button.



- 3 Tap the Institch Cloud folder.

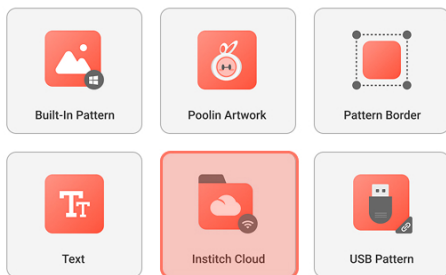

- 4 Patterns saved to the device will be listed here.

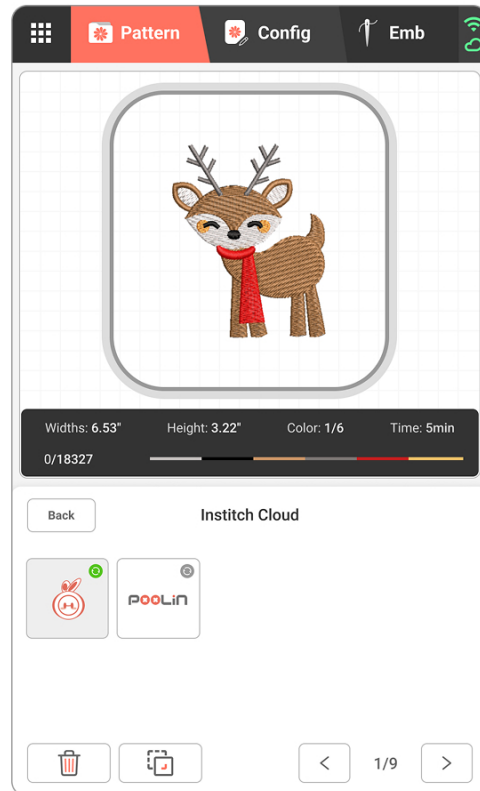

# Delete Edited Pattern

Note: Only edits within the frame range can be saved successfully, please pay attention to the border line of the frame in the preview area.

1 Click the Delete button.

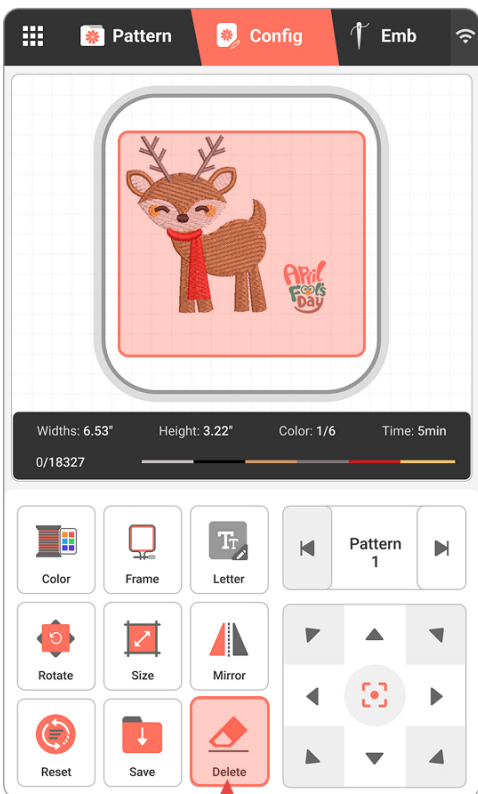

2 The pattern will be deleted.

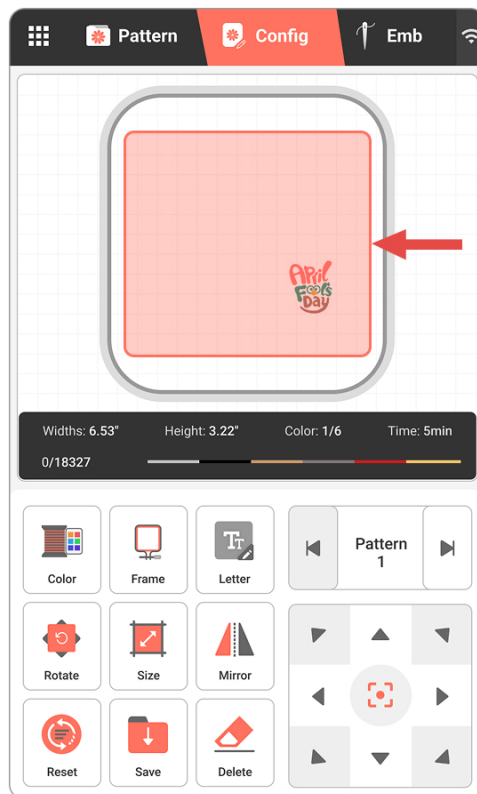

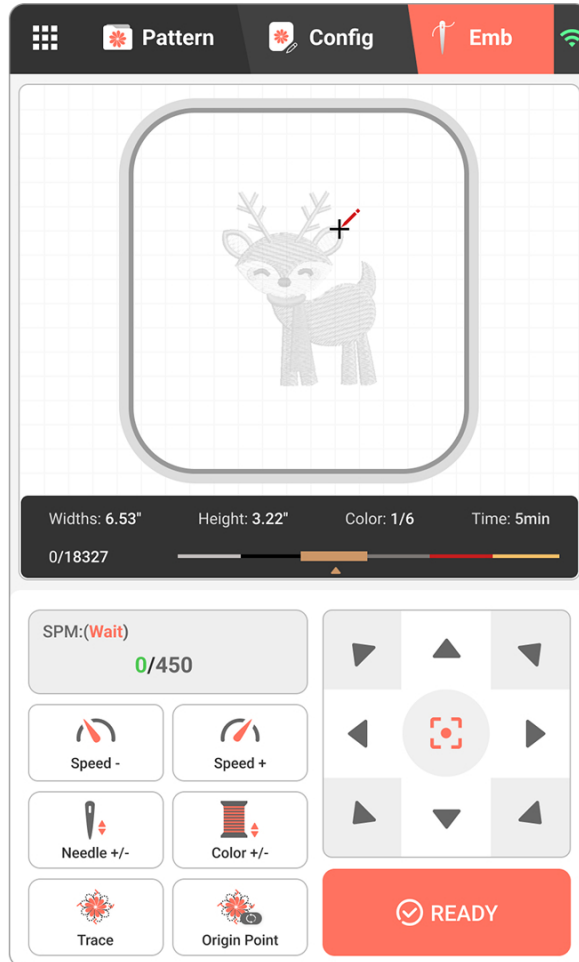

# Pattern Embroidery Page Introduction



## Description of Functions

### Contents

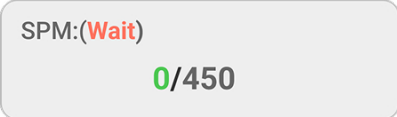
### Description

Contents	Description
	<p>Real-time embroidery speed/maximum embroidery speed. There are 6 status:</p> <ol style="list-style-type: none"> <li>1. Wait</li> <li>2. Ready</li> <li>3. Working</li> <li>4. Pause</li> <li>5. Thread Broken</li> <li>6. Complete</li> </ol>
	Embroidery speed down.

# Pattern Embroidery Page Introduction

## Contents

## Description



Embroidery speed up.



Forward/backward by the number of stitches.

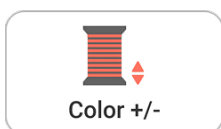

Forward/backward by color.

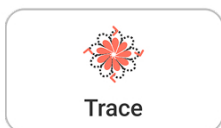

Pattern tracing: before embroidery starts, trace along the largest edge of the pattern, it is used to determine the embroidery position of the pattern in the embroidery.



Return to the starting point: Return to the starting point during the embroidery to restart embroidery. In the state of embroidery, perform the operation of returning to the starting point to stop embroidery and return to the starting point, please select as required.



Working state switching key (READY/EXIT) . Press the key to switch:

- READY : indicates the ready state, the selection of pattern must be in ready.
- EXIT : means to enter the working state, only in this state can start embroidery.

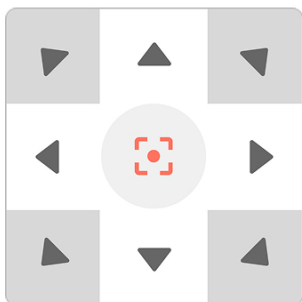

### Move Pattern Within Frame

- Center: Quickly move the pattern to the center of the frame.
- Top Left: Move to the top-left corner of the frame.
- Top Right: Move to the top-right corner.
- Bottom Left: Move to the bottom-left corner.
- Bottom Right: Move to the bottom-right corner.

# Stitch Forward/Backward

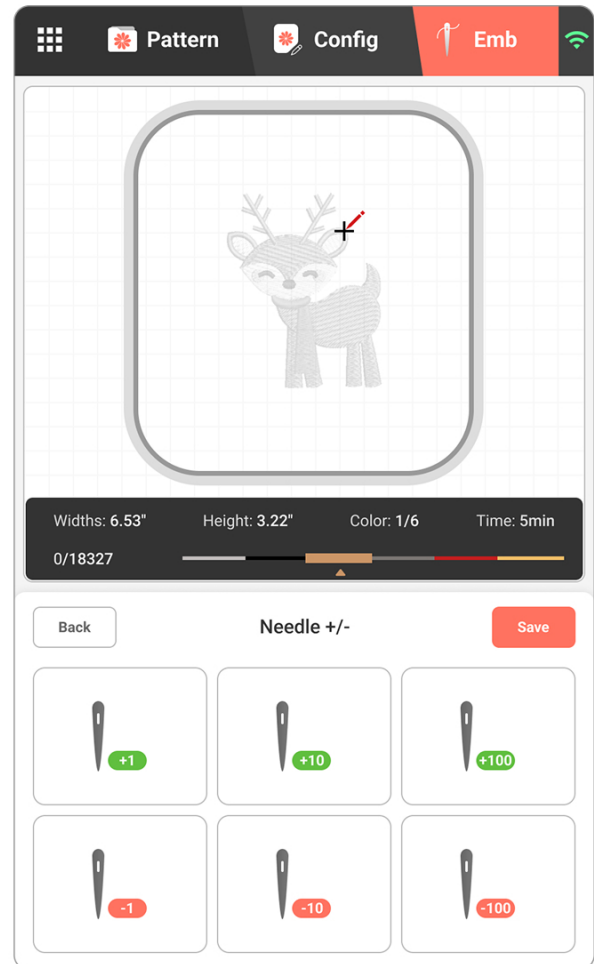
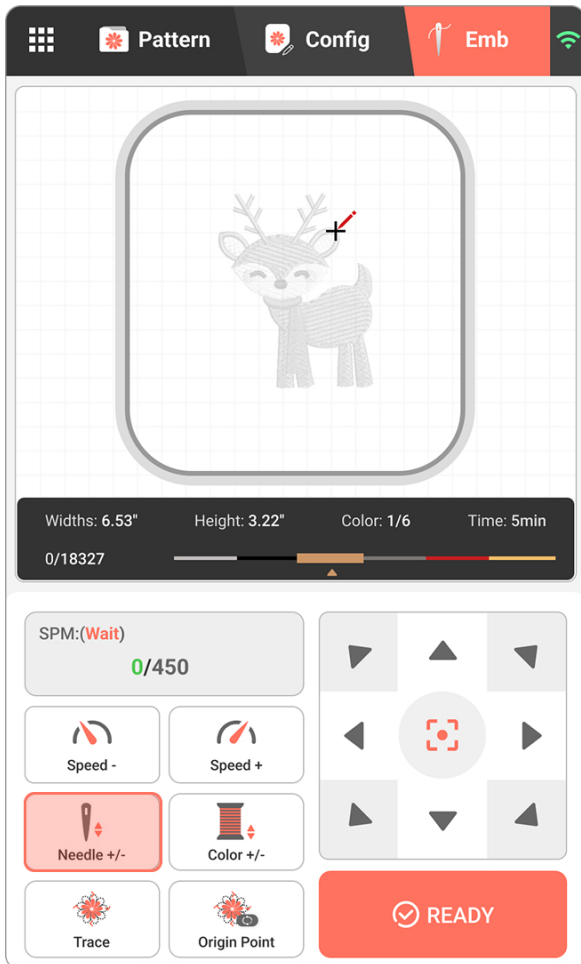

## Description of Functions

### Contents

### Description

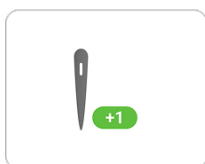

Forward 1 stitch.

Press the key, the pattern will move forward 1 stitch.



Forward 10 stitches.

Press the key, the pattern will move forward 10 stitches.

# Stitch Forward/Backward

## Contents

## Description

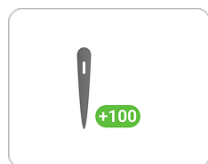

Forward 100 stitch.

Press the key, the pattern will move forward 100 stitches.



Back 1 stitch.

Press the key, the pattern will move backward 1 stitch.

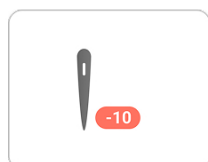

Back 10 stitches.

Press the key, the pattern will move backward 10 stitches.

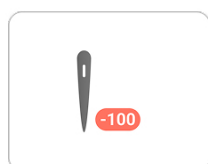

Back 100 stitches.

Press the key, the pattern will move backward 100 stitches.

# Color Forward/Backward

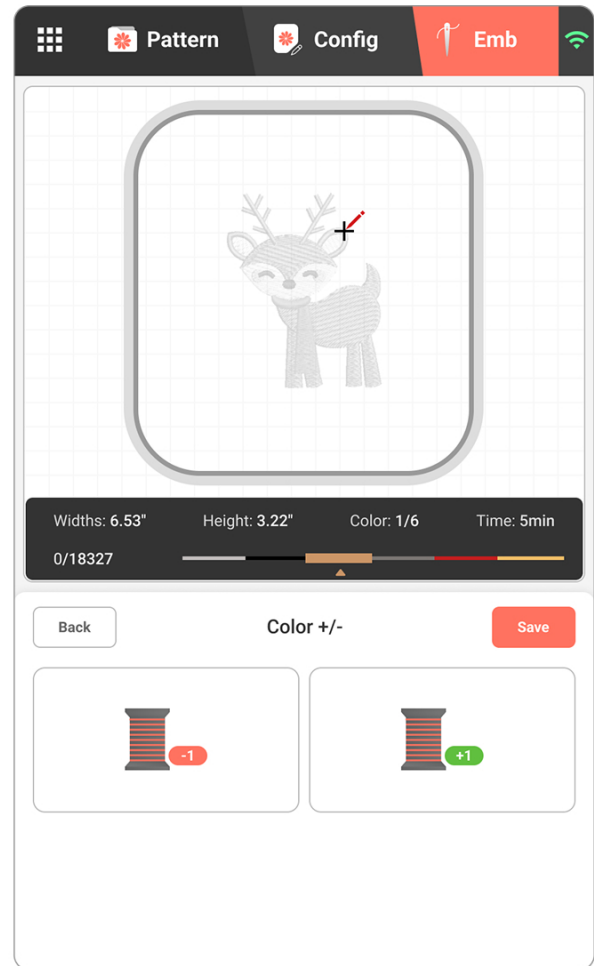
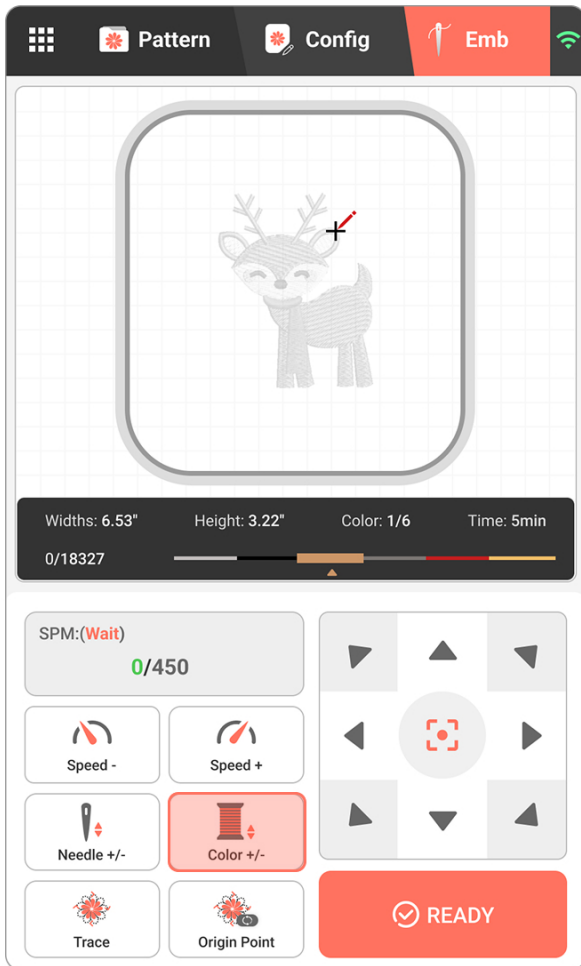

## Description of Functions

### Contents

### Description



Forward color key.  
Press the key, the pattern will go forward 1 color.

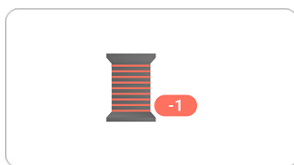

Back color key.  
Press the key, the pattern will go backward 1 color.

# Settings Main Page Introduction

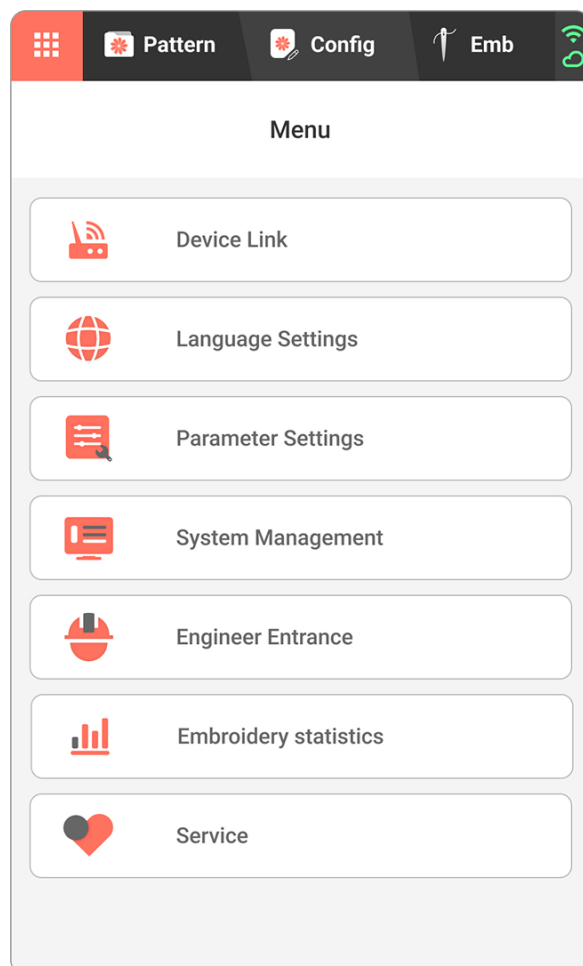

60

## Description of Functions

Contents

Description



Device link Page

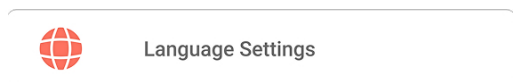

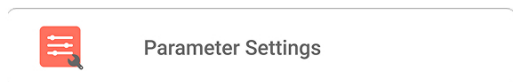

Language Settings



Parameter Settings

# Settings Main Page Introduction

Contents	Description
 System Management	System Management
 Engineer Entrance	Engineer Entrance
 Embroidery statistics	Embroidery Statistics
 Service	Service

# Common Issues and Solutions

Error Message	Cause of Issue	Solution
Thread breaking	The upper thread is threaded incorrectly.	Follow the operation of threading the upper thread, re-thread the thread.
	Upper thread tension is too tight.	Adjust tension.
	Thread jammed.	Clean up the jam.
	Thread doesn't fit the needle.	Use proper needle and thread.
	Bobbin case scratches.	Replace the bobbin case.
	The needle is not installed correctly.	Correctly install the needle.
Needle breaking	Upper thread tension is too tight.	Adjust tension.
	Thread jammed.	Clean up the jam.
	Needle doesn't fit the fabric.	Use a larger needle.
	The needle is not installed correctly.	Correctly install the needle.
Thread jammed	The upper thread is threaded incorrectly	Follow the operation of threading the upper thread, re-thread the thread.
	Upper thread tension is too loose	Adjust tension.
Stitches skipped	Needle doesn't fit.	Use the proper needle.
	Needle bending.	Replace the needle.

# Common Issues and Solutions

Error Message	Cause of Issue	Solution
Stitches skipped	The needle is not installed correctly.	Replace the needle.
	Upper thread tension is too tight.	Adjust tension.
Misplaced embroidery	Fabric unclamped.	Clamp the fabric.
	No stabilizer.	Add stabilizer.
	When the embroidery frame is working, it bumps to the surrounding objects.	Do not place any objects around the embroidery frame.
Thread unlocked	The upper thread is threaded incorrectly.	Follow the operation of threading the upper thread, re-thread the thread.
	No bobbin.	Reinstall the bobbin.
	The thread does not fit the needle.	Use proper needle and thread.
USB not recognized	The USB format does not match or the memory is too large	Please use the offered USB device or purchase a USB device with a capacity of less than 64GB and a format of FAT32.
Pattern not recognized	Pattern format is incorrect	This machine only supports pattern files in DSB/DST format.

## More Stitch More Love



*YouTube*

