

ATLANTA

DIMENSION

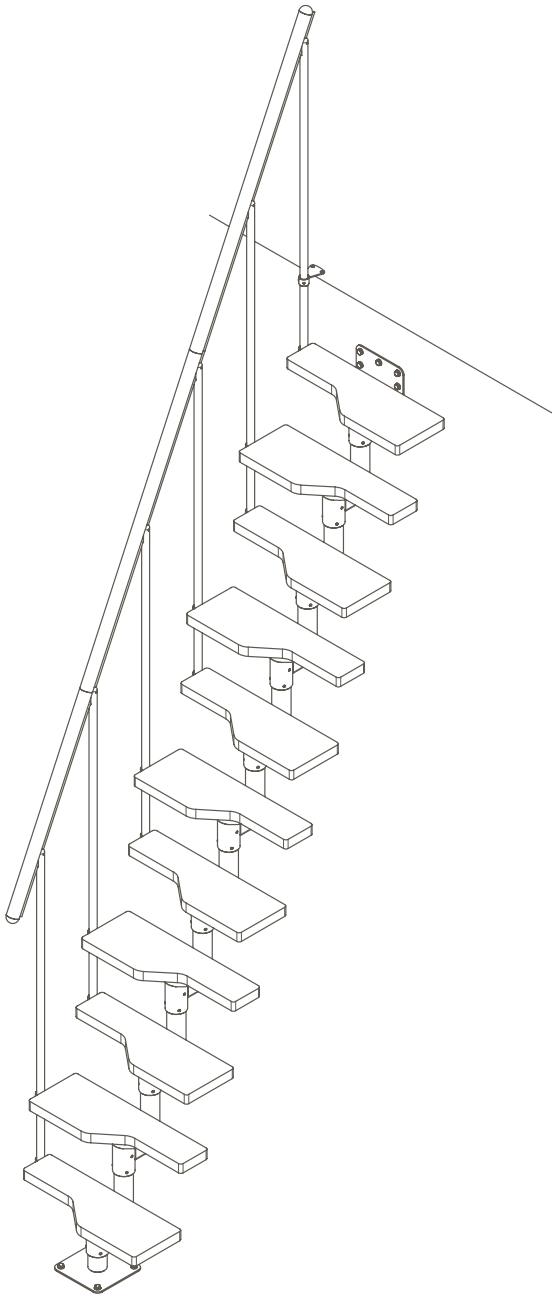

STAIRCASE TERMINOLOGY

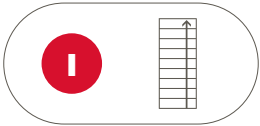



C1

E

G

H

M

	Staircase width w. 1 banister	Headroom	Going (of tread)	Height floor-to-floor	Upper floor opening length - min.
	Escalier à 1 rampe	Echappée	Giron	Hauteur sol-sol	Longueur de trémie min.
	Trap met 1 leuning	Vrije doorphoogte	Aantrede	Hoogte vloer/vloer	Minimum traplengte
	Treppenbreite inkl. 1 Geländer	Kopffreiheit	Auftrittsbreite	Geschosshöhe	Öffnungsgröße länge min.
	Ancho de la escalera con 1 barandilla	Altura de paso libre	Huella	Altura de suelo/suelo	Longitud mínima del hueco
	Largura da escada com 1 corrimão	Altura de passagem livre	Pegada	Altura do chão / chão	Comprimento mínimo da lacuna (Vão)
	Lățime scară cu 1 balustradă	Înălțimea liberă de trecere	Lățime utilă treaptă	Înălțime sol-sol	Lungime gol scară







N

O

P

R

R1

	Upper floor opening width - min.	Clear width	Pitch	Total going length	Total going width
	Largeur de trémie min.	Largeur de passage	Pente de l'escalier	Recul total - longueur	Recul total - largeur
	Minimum trapbreedte	Doorgangsbreedte	Hellingsgraad	Totale terugloop - lengte	Totale terugloop - breedte
	Öffnungsgröße breite min.	Durchgangsmaß	Winkel	Ausladung länge	Ausladung breite
	Ancho mínimo del hueco	Ancho útil	Pendiente (Inclinación) de la escalera	Espacio al suelo largura	Espacio al suelo anchura
	Largura mínima da lacuna	Largura útil	Declive (inclinação) da escada	Comprimento do piso	Largura do piso
	Lățime gol scară	Lățime utilă	Unghi scară	Proiecția la sol lungime	Proiecția la sol lățime



S

T

V

W

X

	Rise height	Number of treads	Tread depth	Tread width	Tread thickness
	Hauteur de marche	Nombre de marches	Profondeur de marche	Largeur de marche	Epaisseur de marche
	Hoogte trede	Aantal treden	Diepte van de trede	Breedte van de trede	Dikte van de trede
	Steigungshöhe	Anzahl Stufen	Stufen tiefe	Stufen breite	Stufen Stärke
	Altura de peldaños	Numero de peldaños	Profundidad del peldaño	Ancho del peldaño	Espesor del peldaño
	Altura do degrau	Número de etapas (degraus)	Profundidade do passo	Largura do passo	Espessura do passo
	Înălțime treaptă	Număr trepte	Adâncime treaptă	Lățime treaptă	Grosime treaptă

Z

	Deck thickness
	Epaisseur de dalle
	Plafond dikte
	Deckenstärke
	Espesor del techo
	Espessura do telhado
	Grosime dală

DIMENSIONS

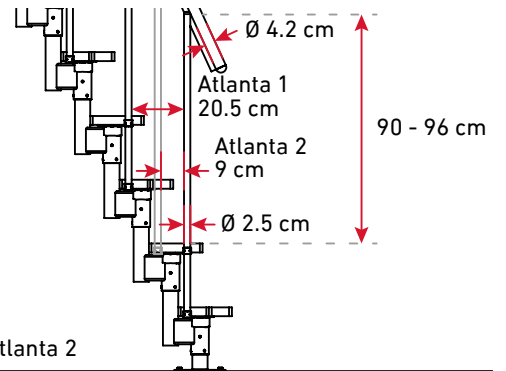
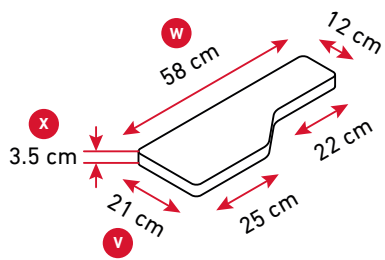
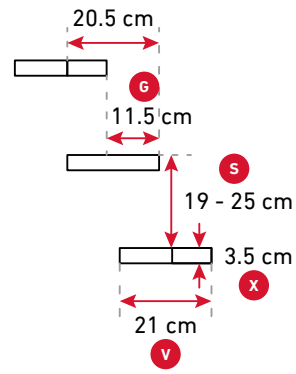
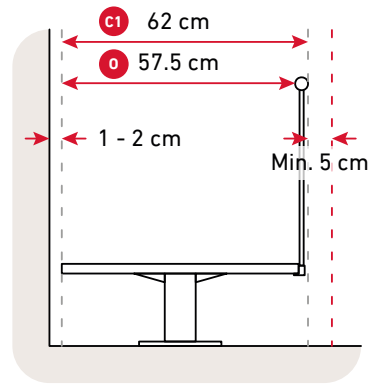
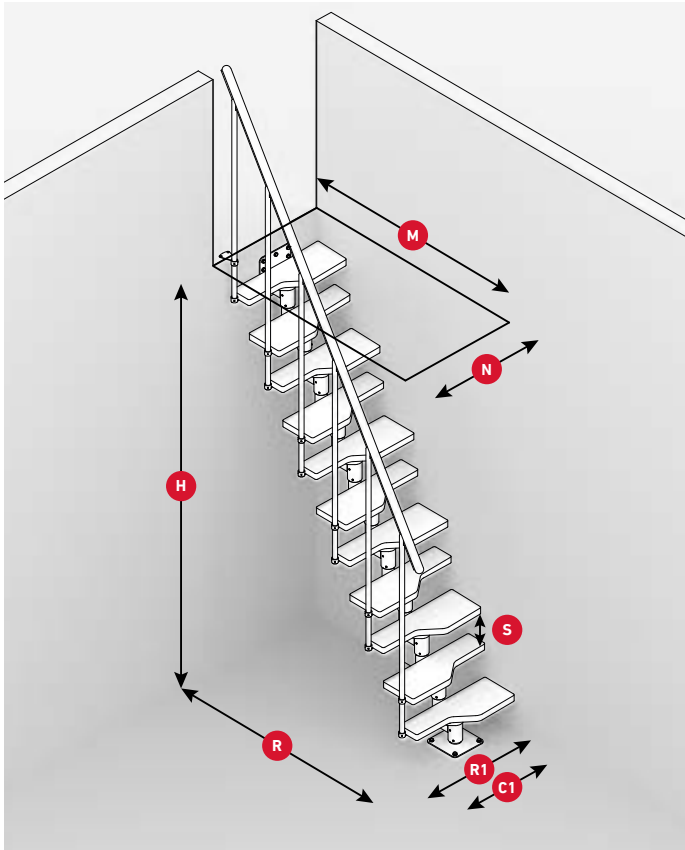

Atlanta 1 & Atlanta 2

DIMENSIONS

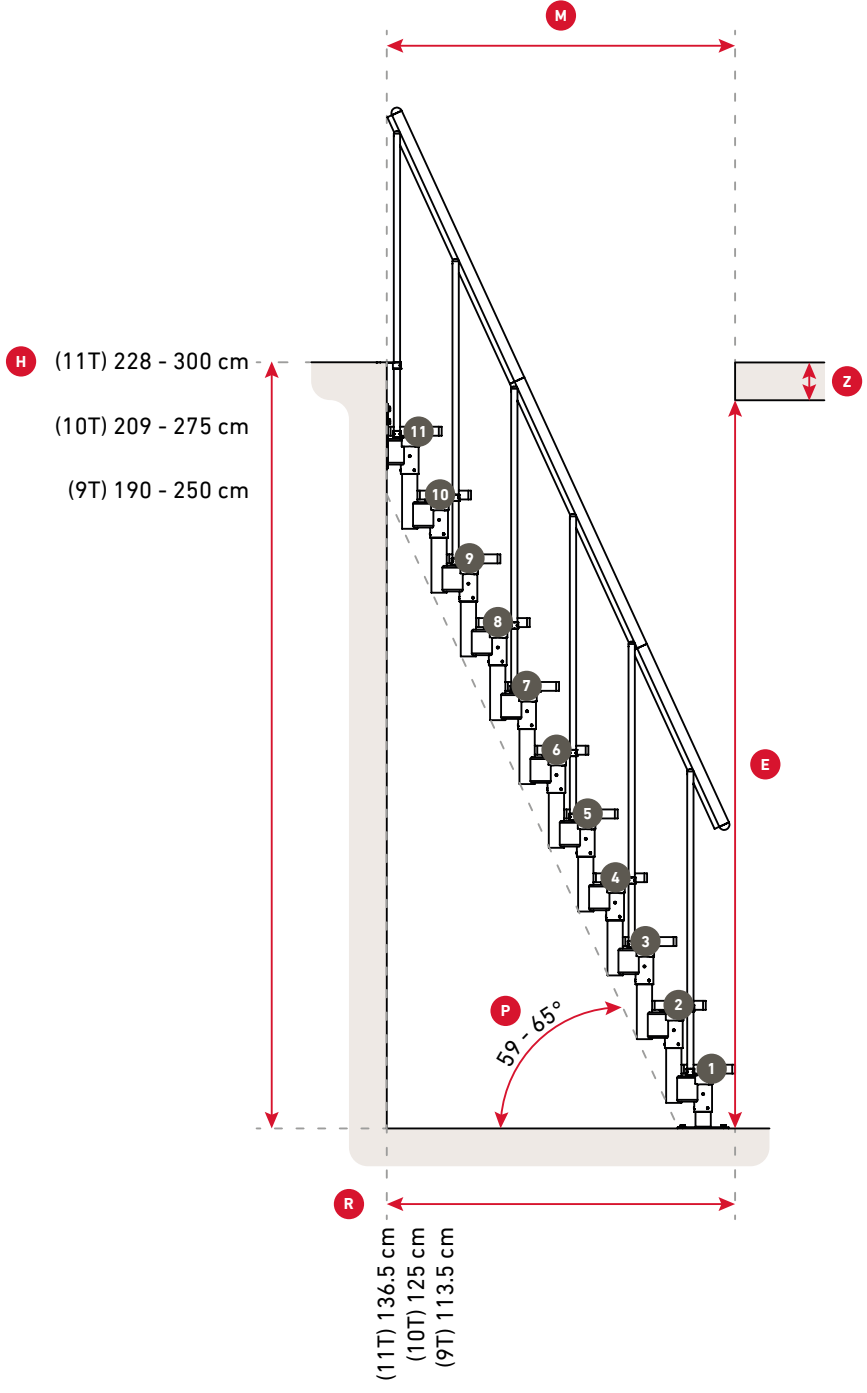

ATLANTA 11 TREADS

H 228 - 300 cm

— Staircase dimensions incl. handrail on 1 side

- - - Floor opening size is defined based on 2 cm space to wall, 5 cm space for hand, 19 cm rise height, 25 cm deck thickness, 200 cm headspace.

