

**PGC**

P3

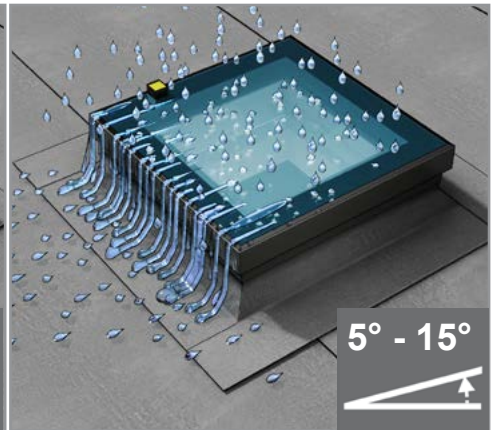

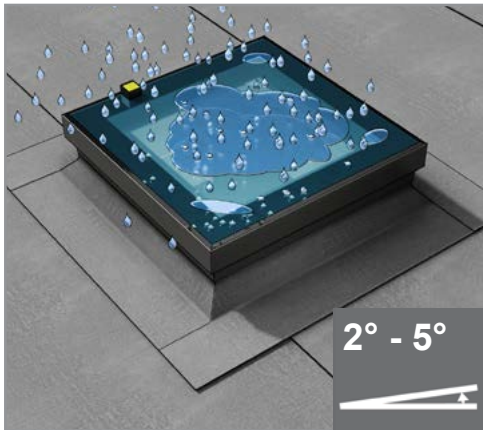
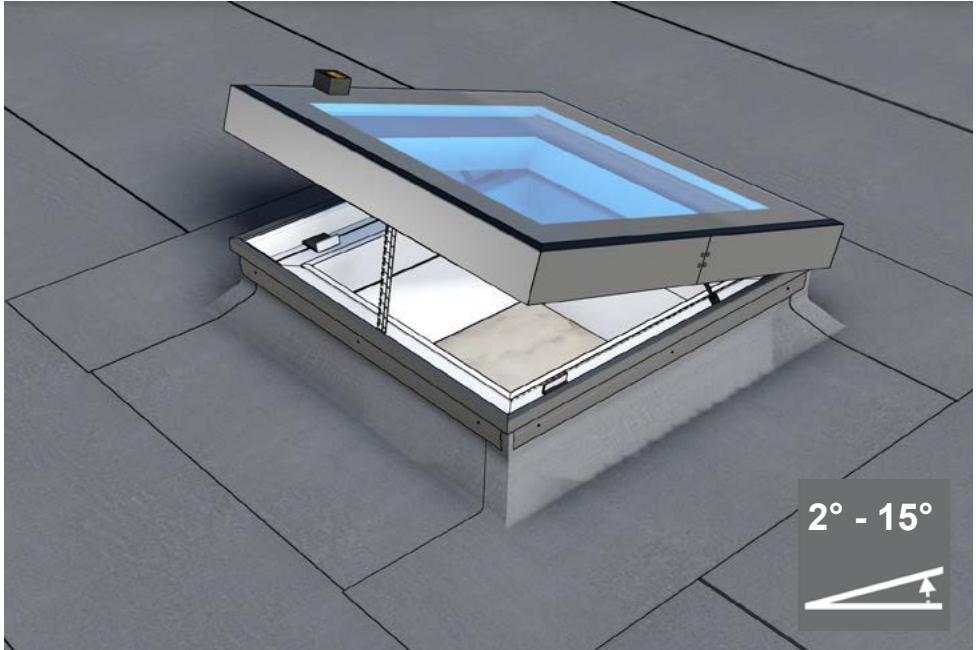
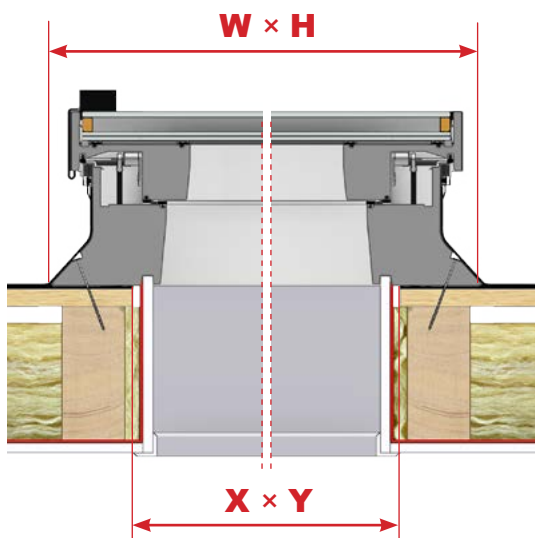
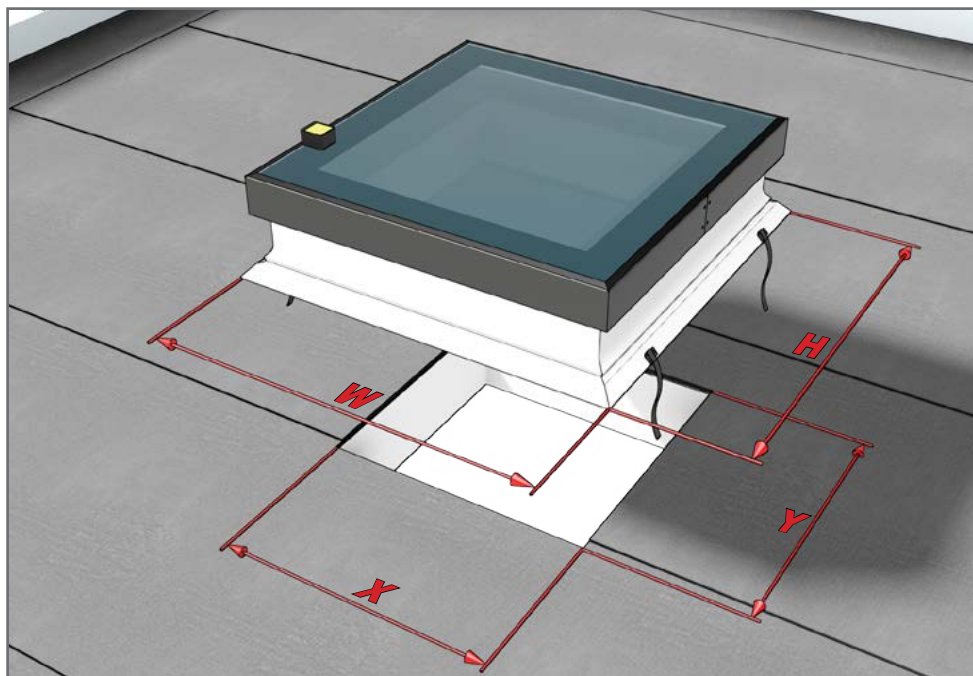

PGC	X [mm]	Y [mm]	W [mm]	H [mm]
60 x 60	600	600	799	799
70 x 70	700	700	899	899
80 x 80	800	800	999	999
90 x 60	600	900	1099	799
90 x 90	900	900	1099	1099
100 x 100	1000	1000	1199	1199
120 x 60	1200	600	1399	799
120 x 90	1200	900	1399	1099
120 x 120	1200	1200	1399	1399
150 x 100	1500	1000	1699	1199

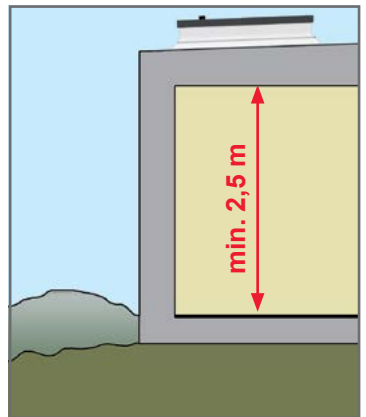
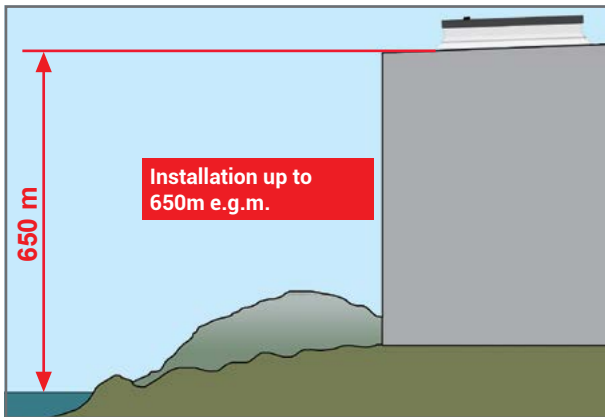
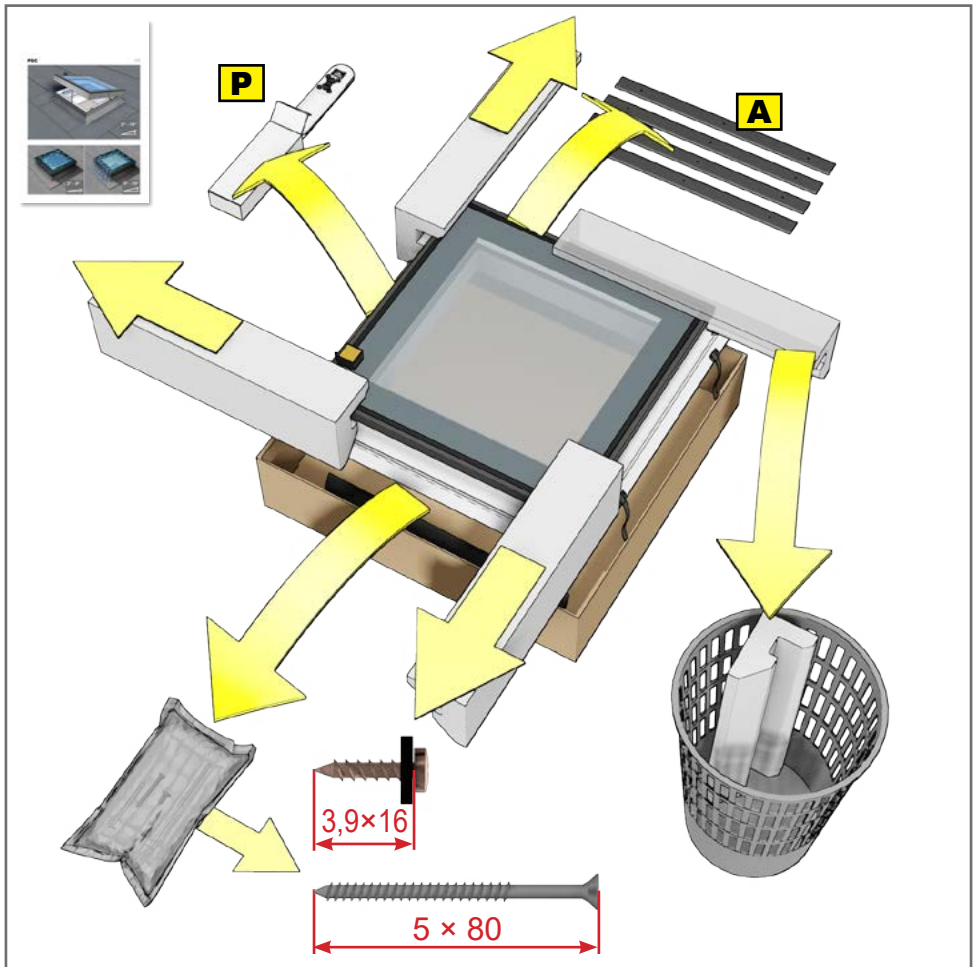

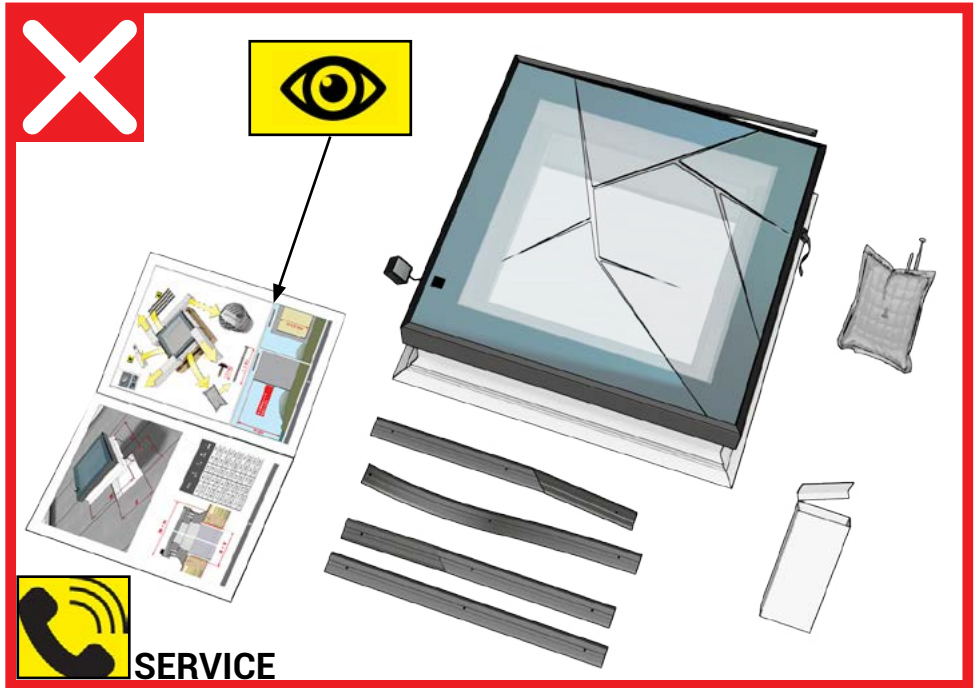
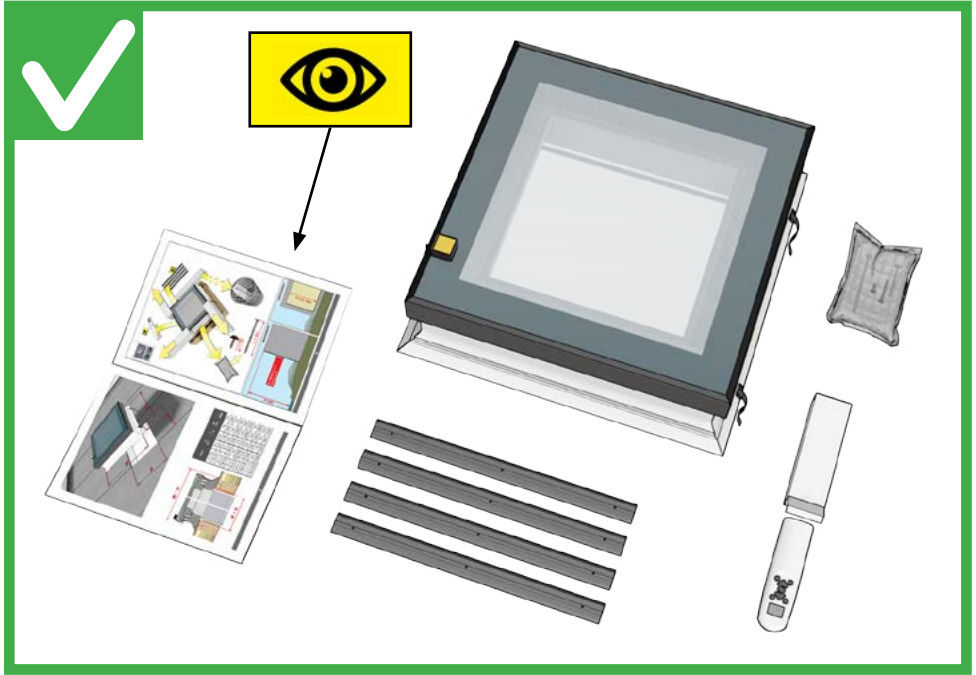

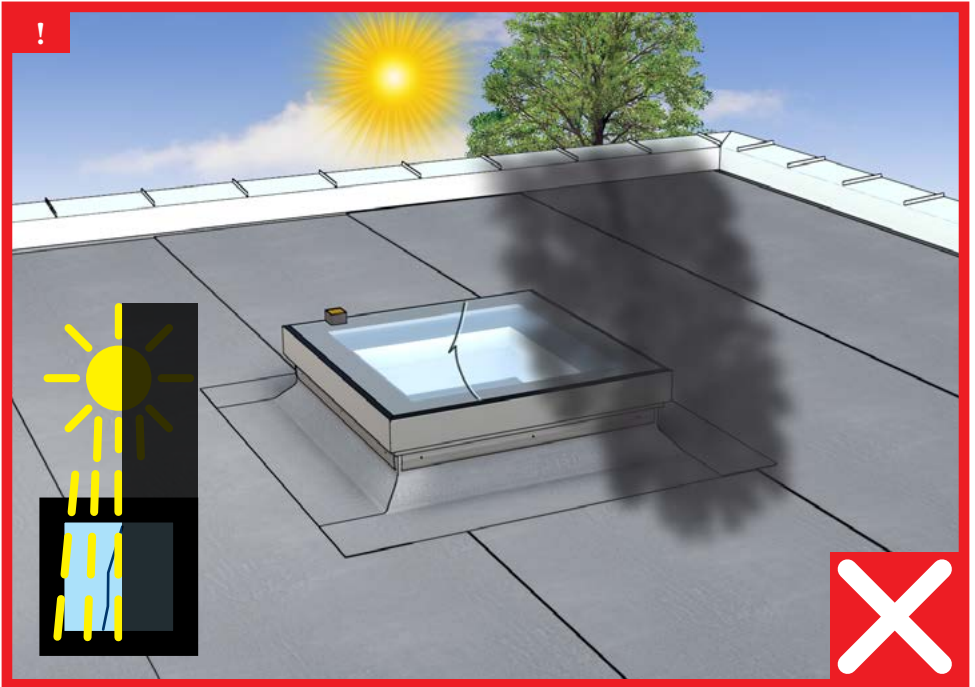
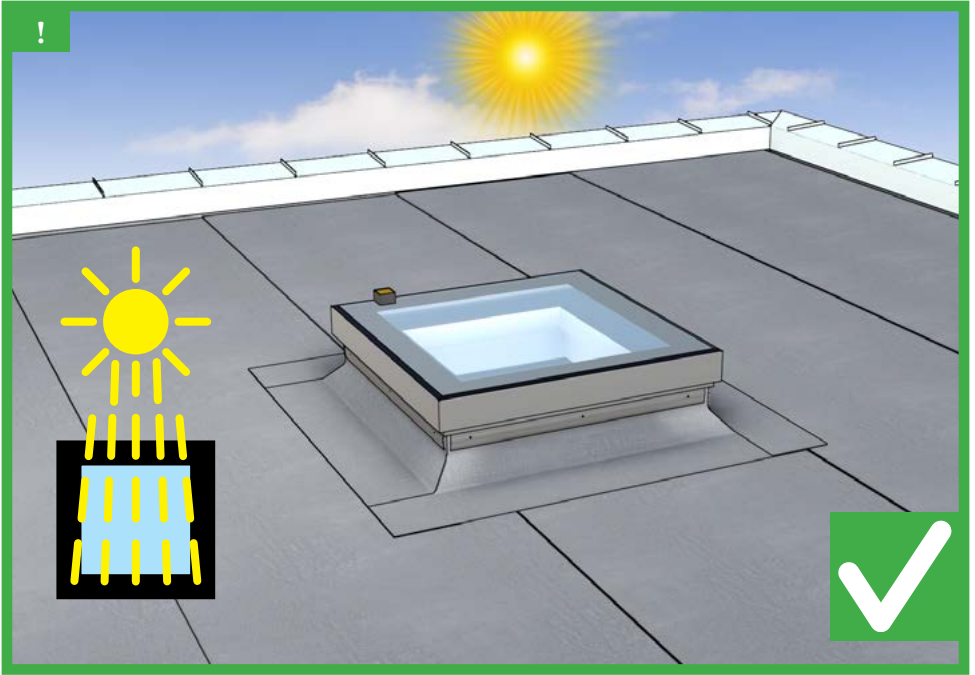



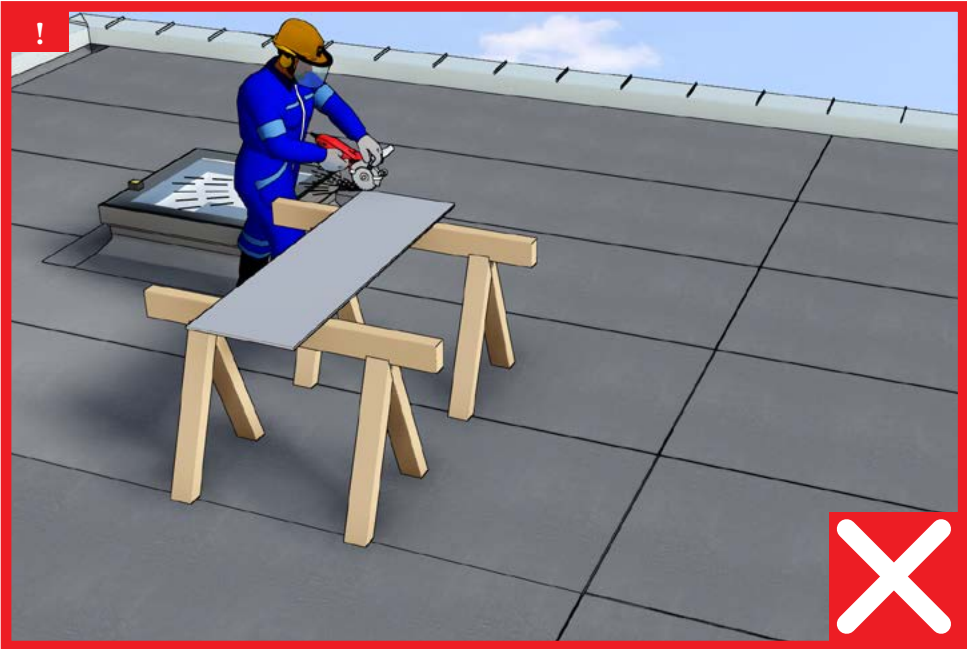
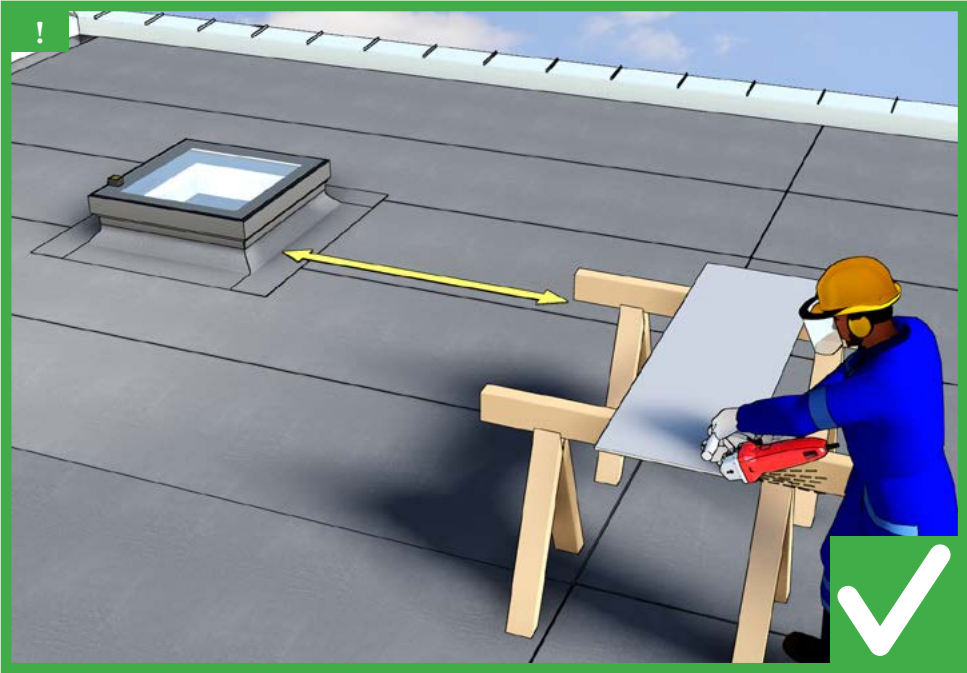

1a

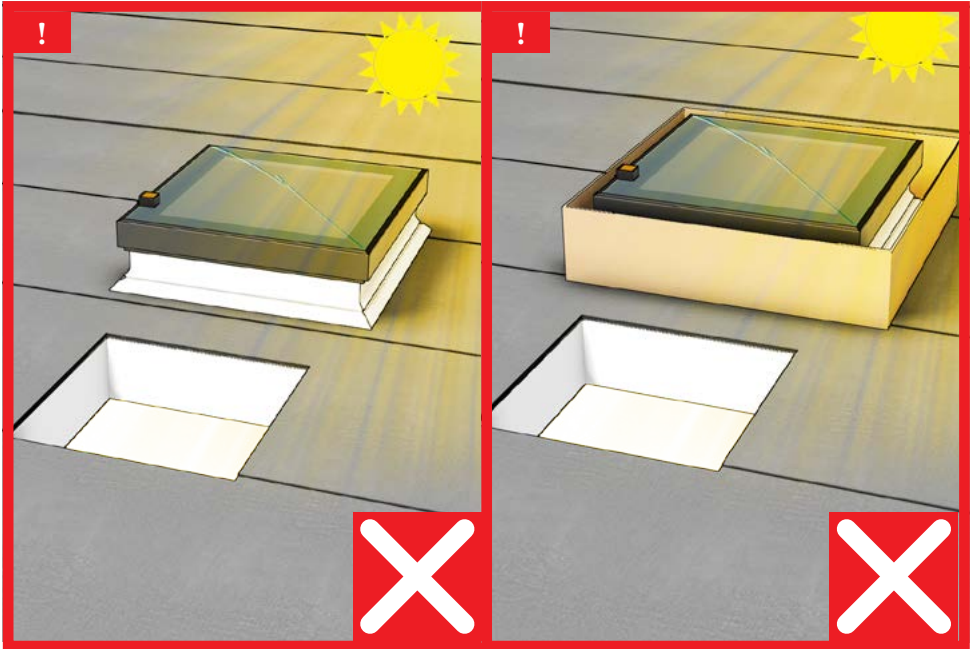

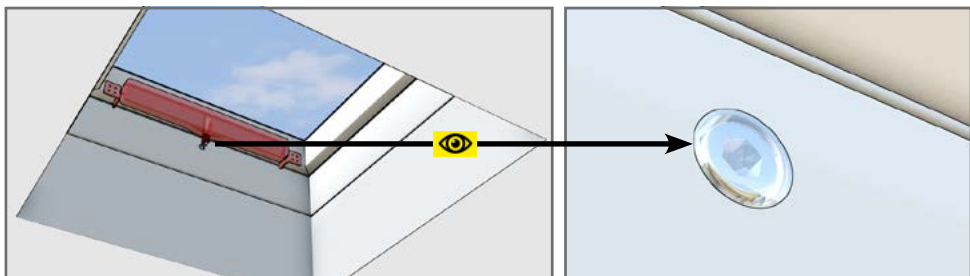
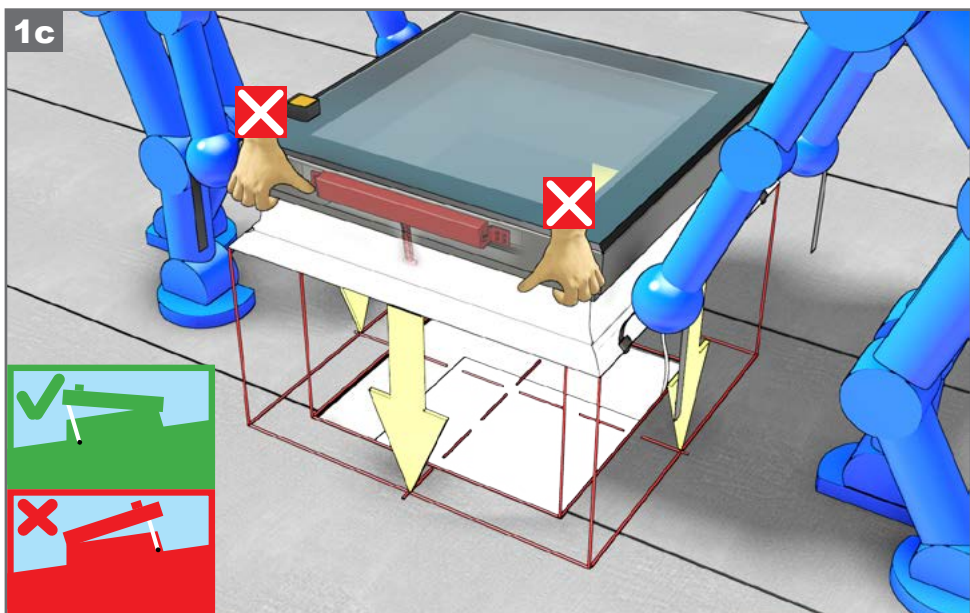
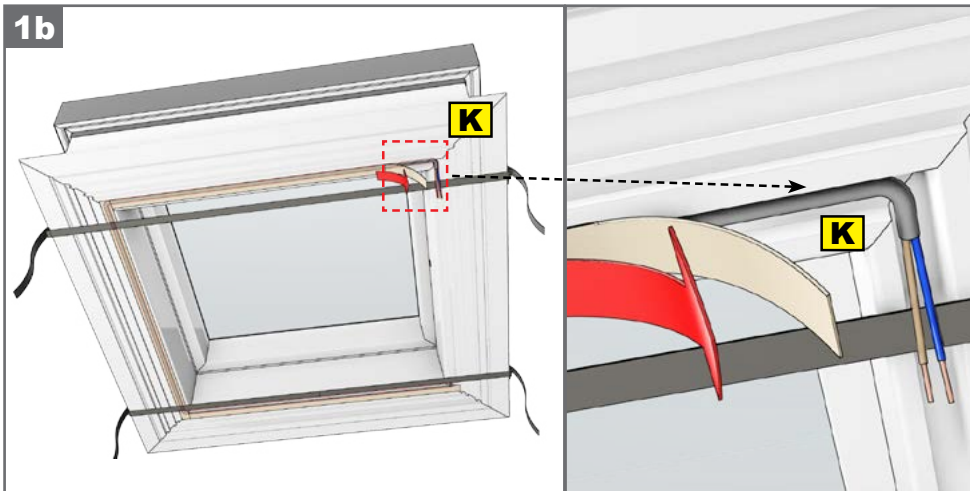



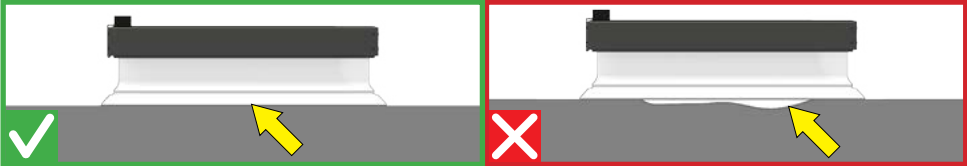

1d

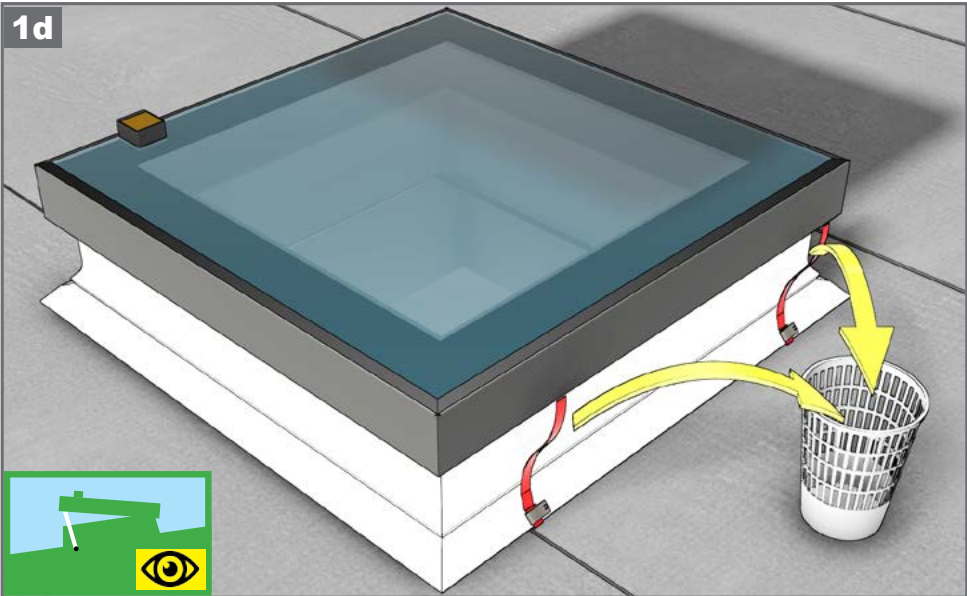

2

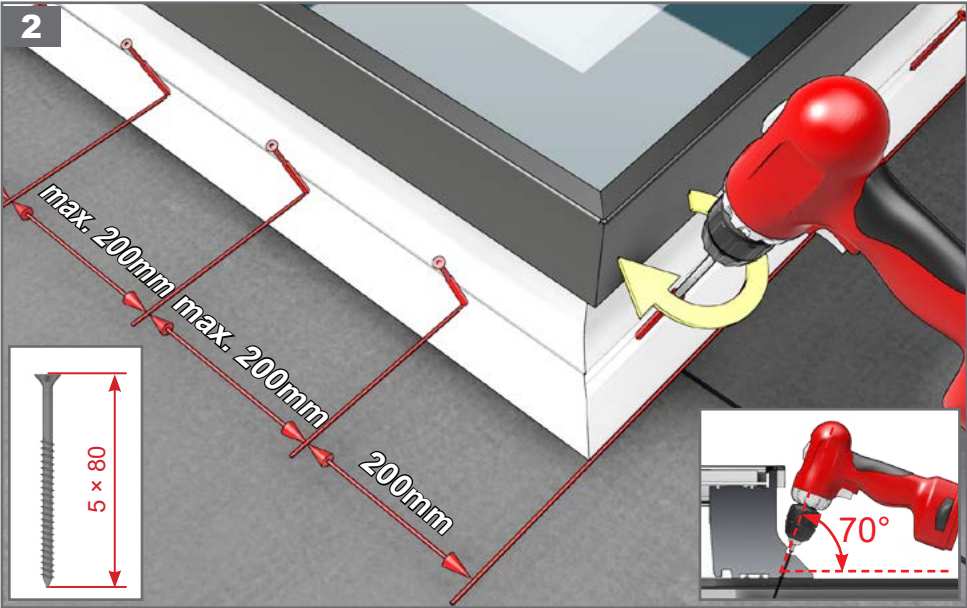

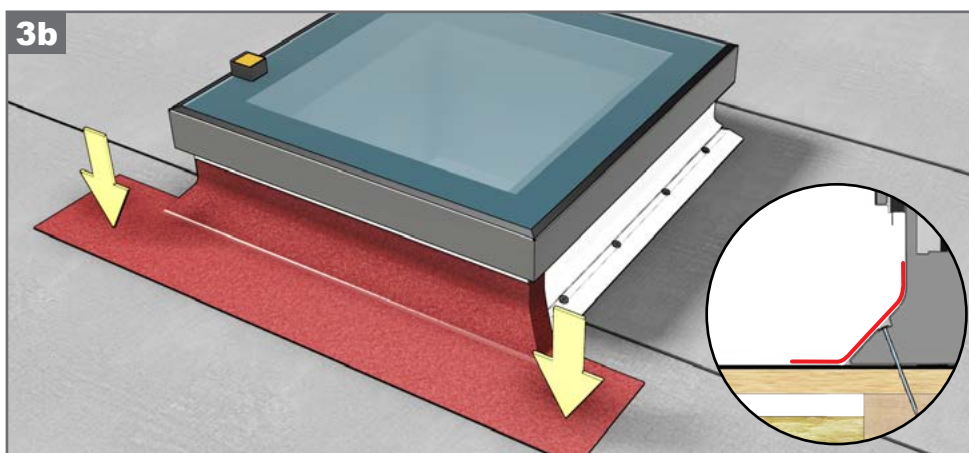
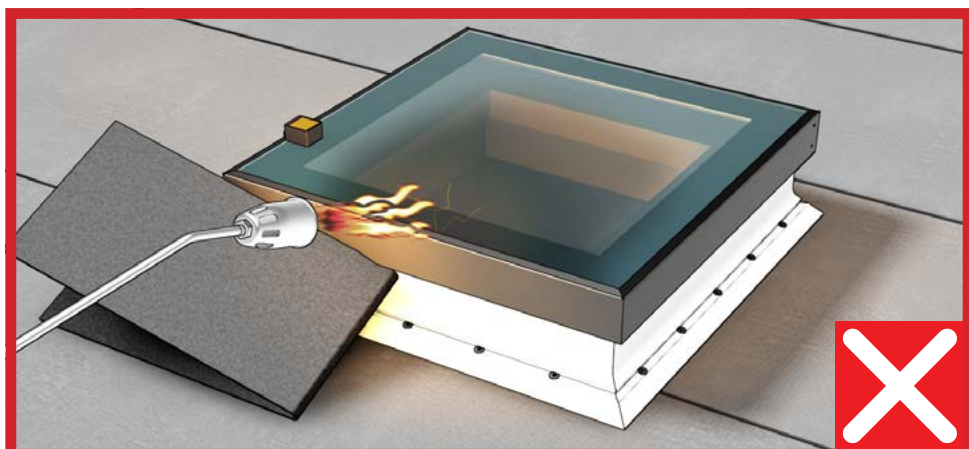
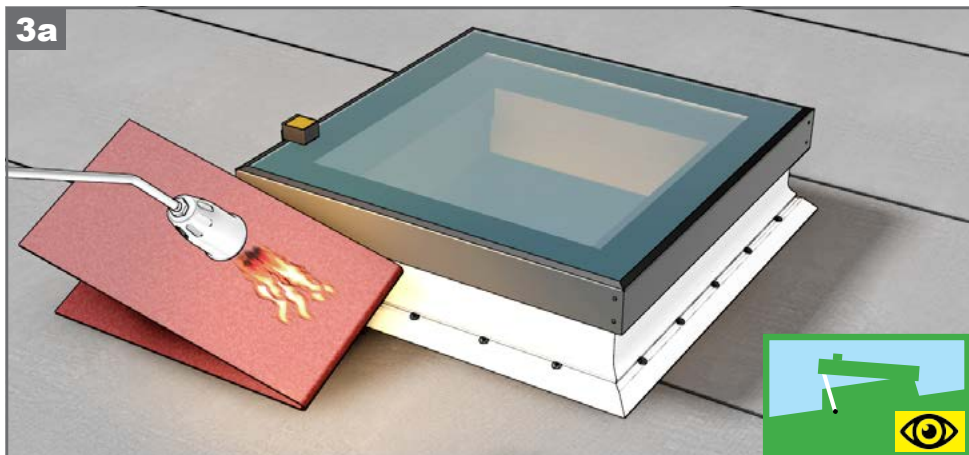

3c

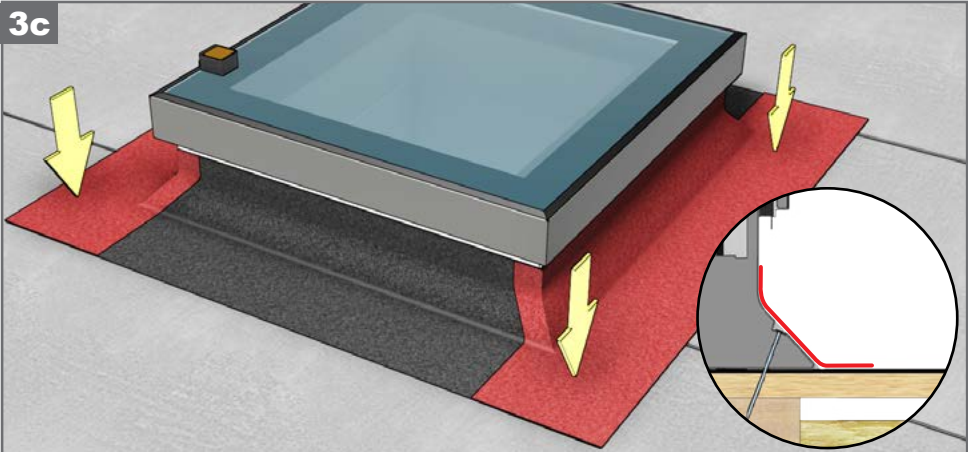

3d

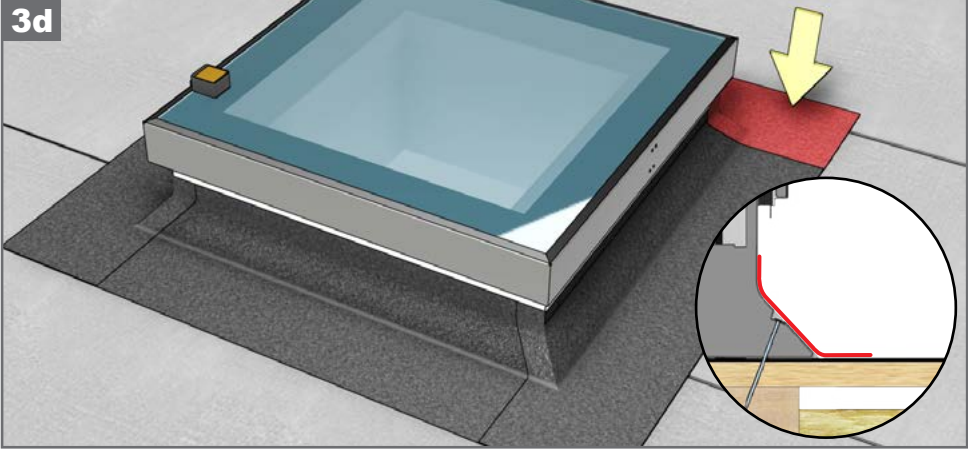

4a

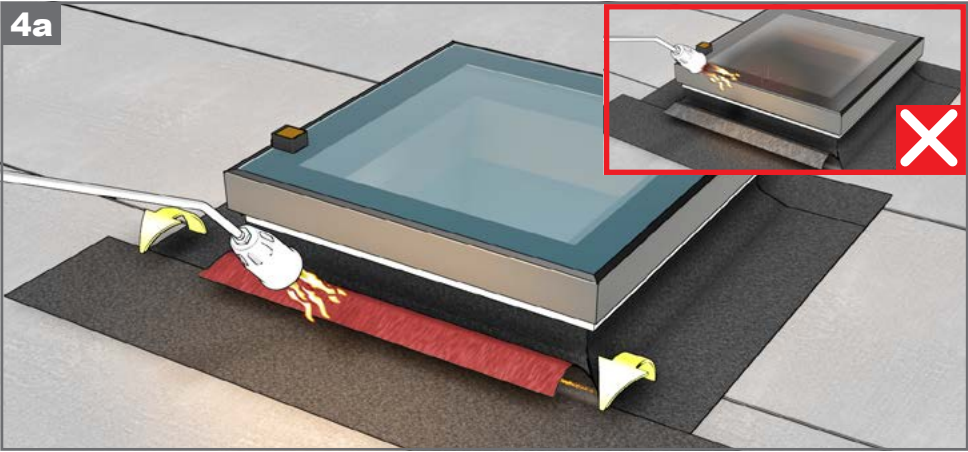



4b

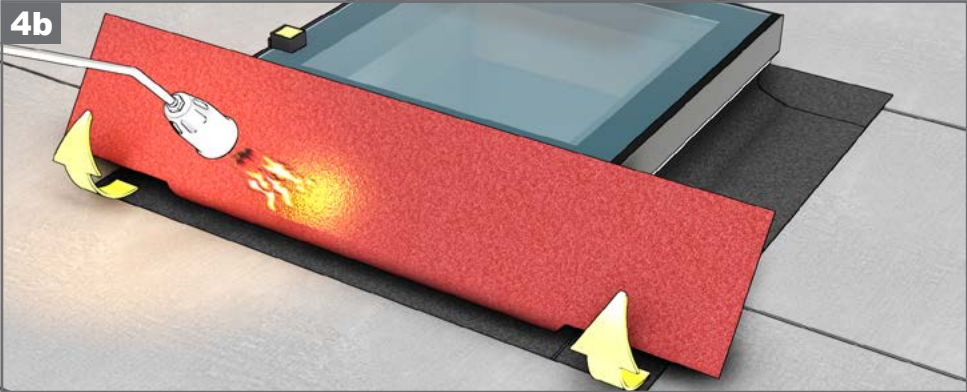

4c

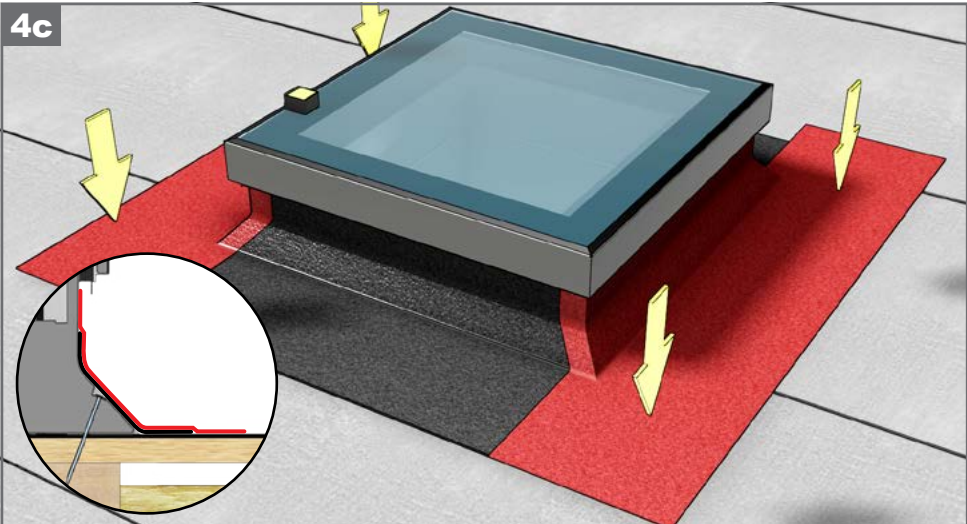

4d

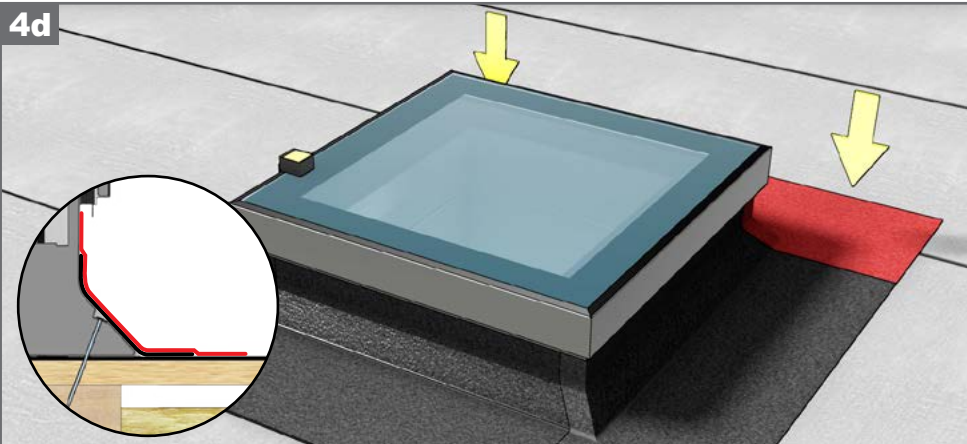



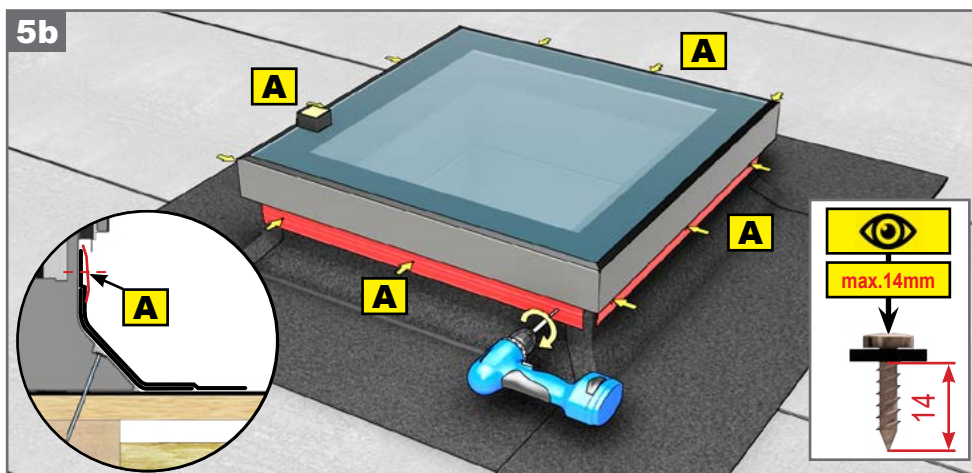
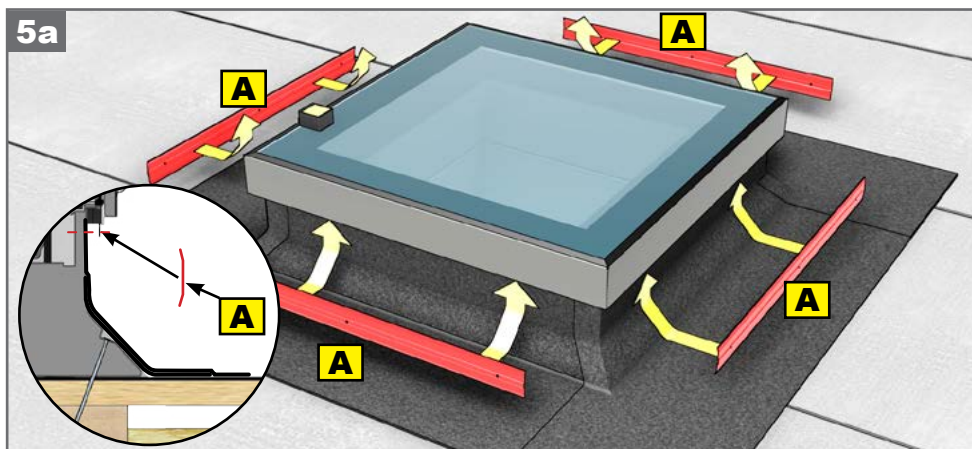

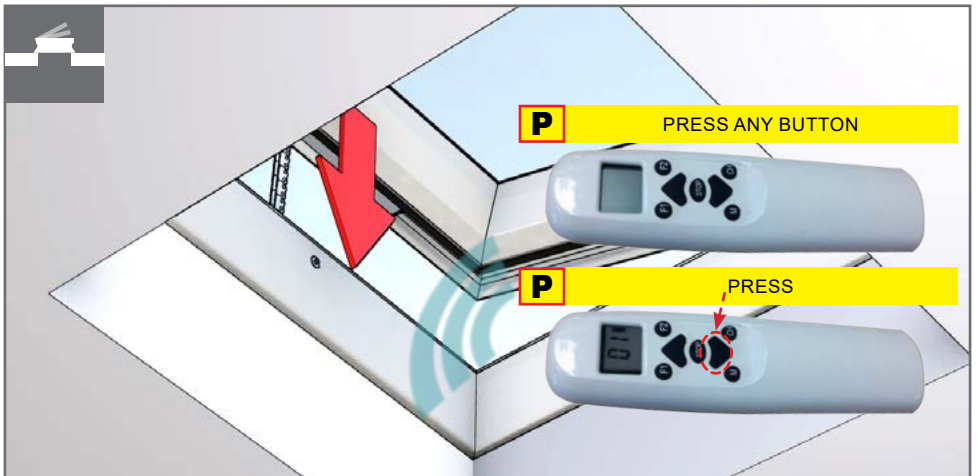
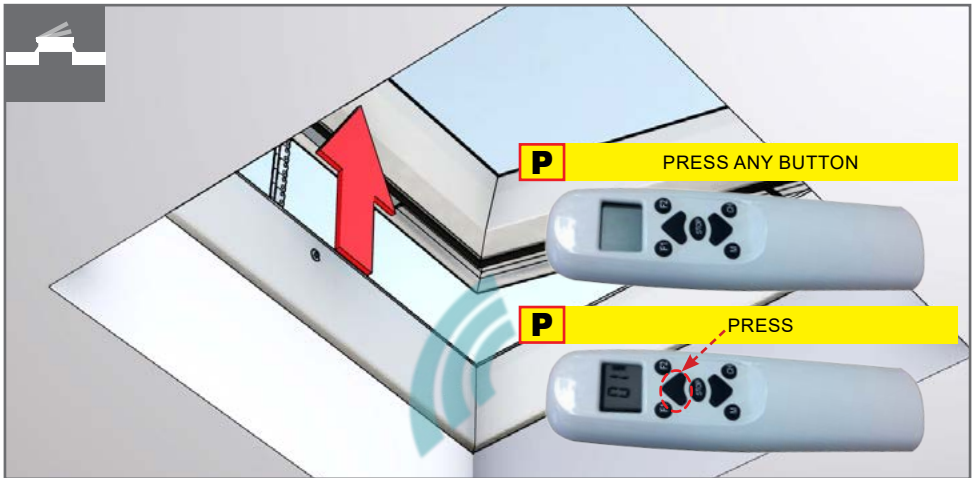
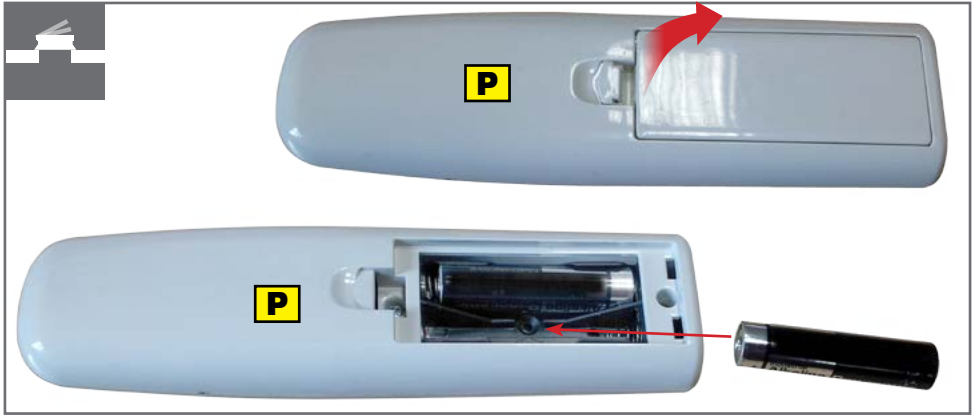

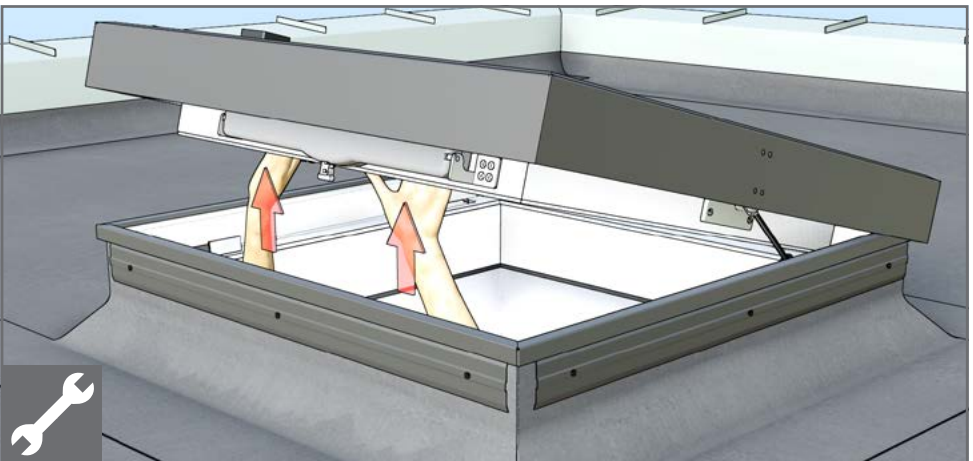
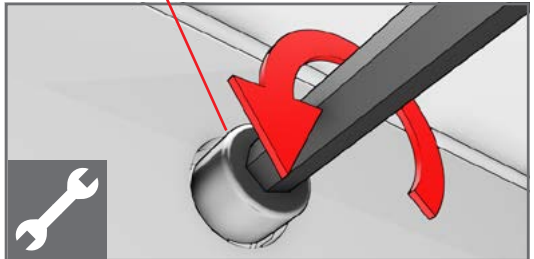
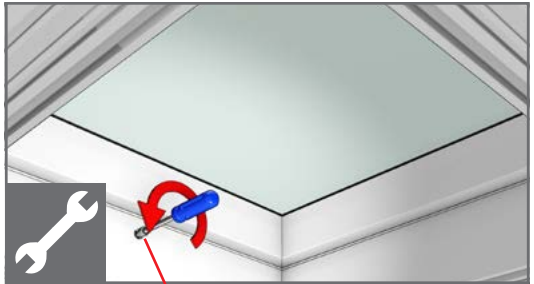
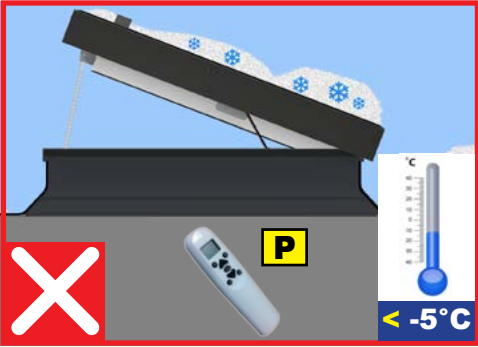

# RESET

1

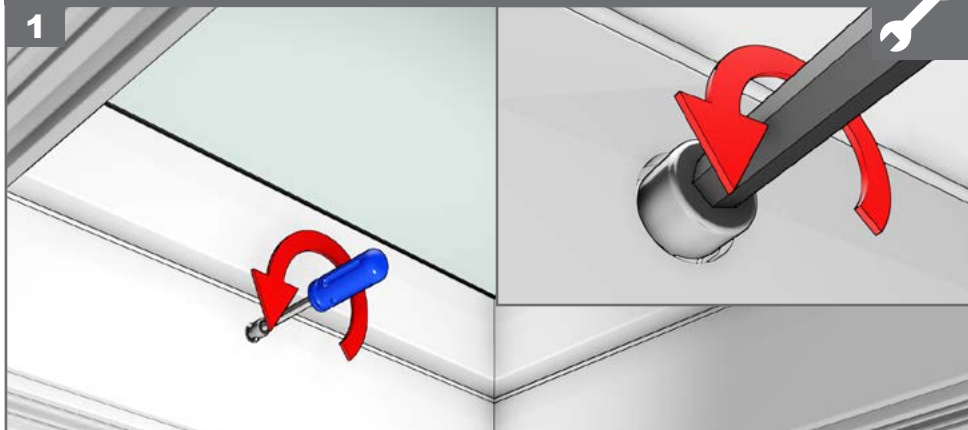

2

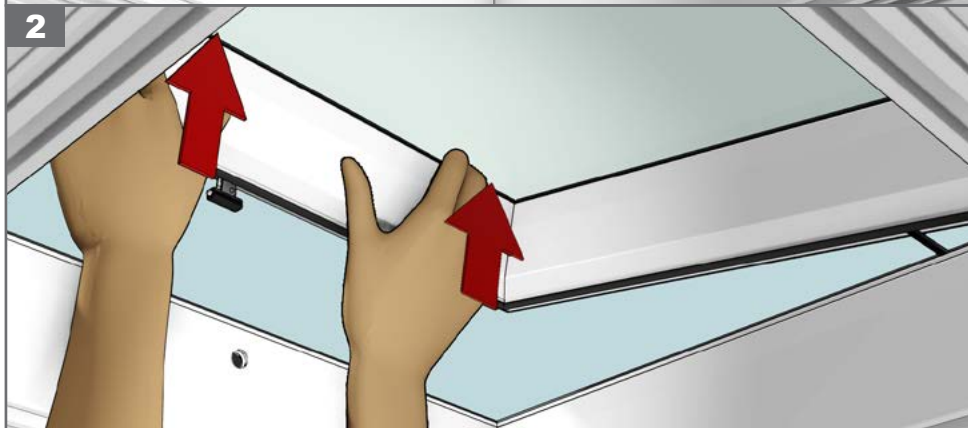

3





# RESET



4

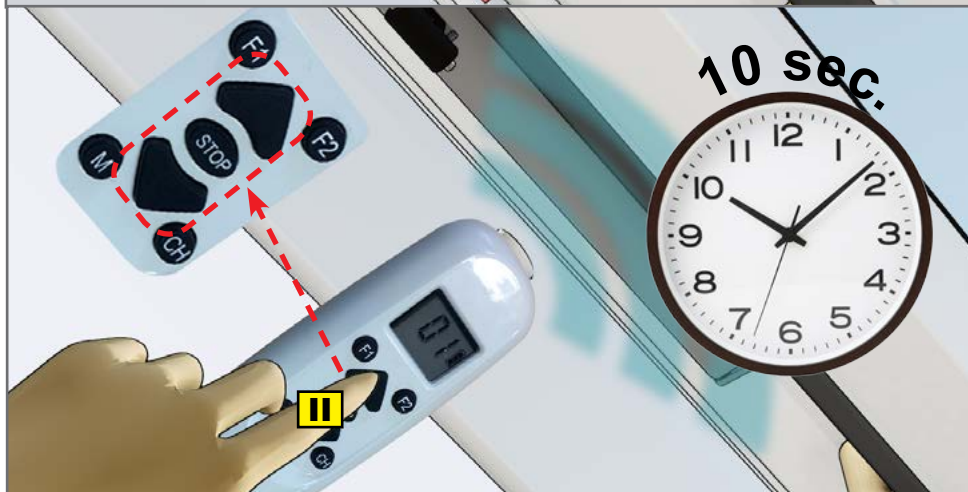
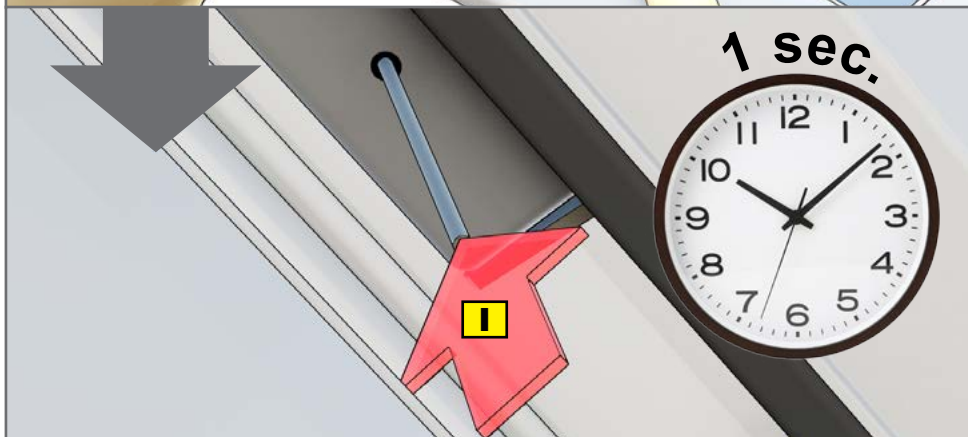
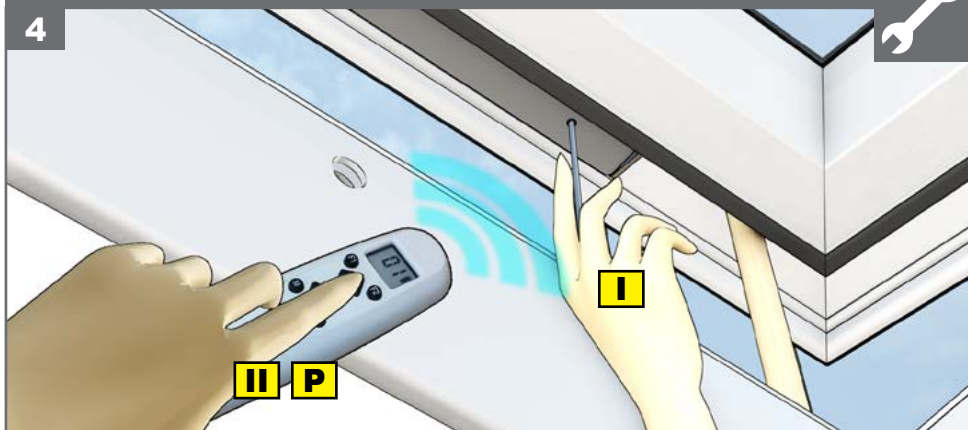

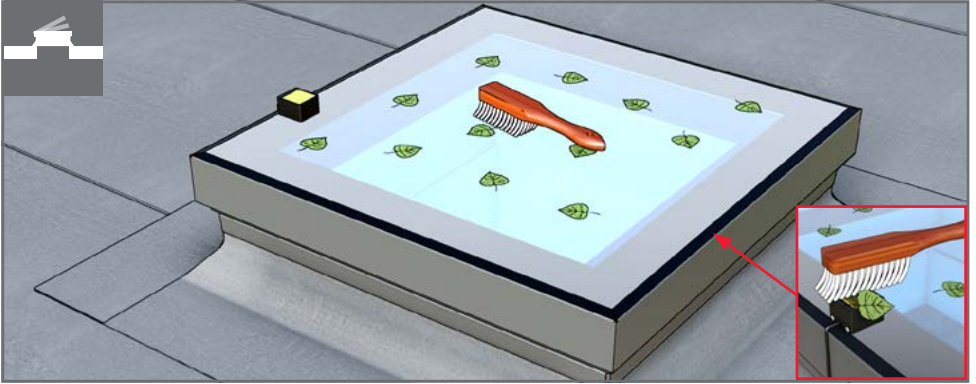

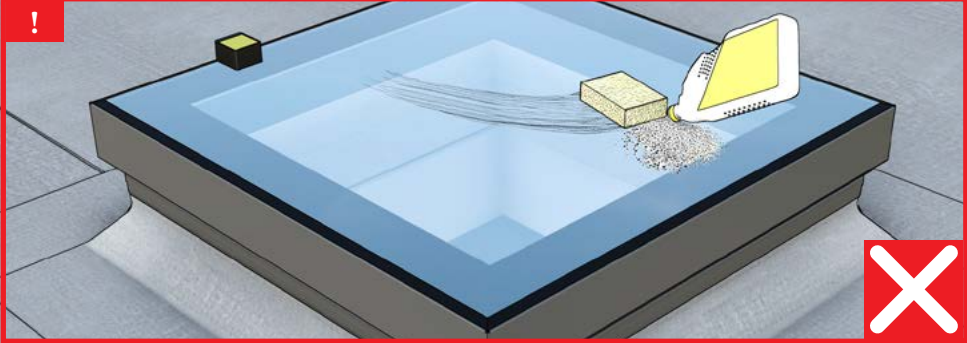
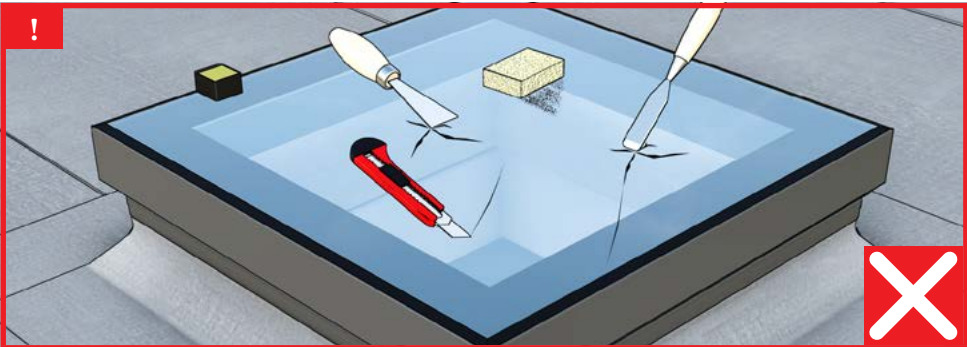
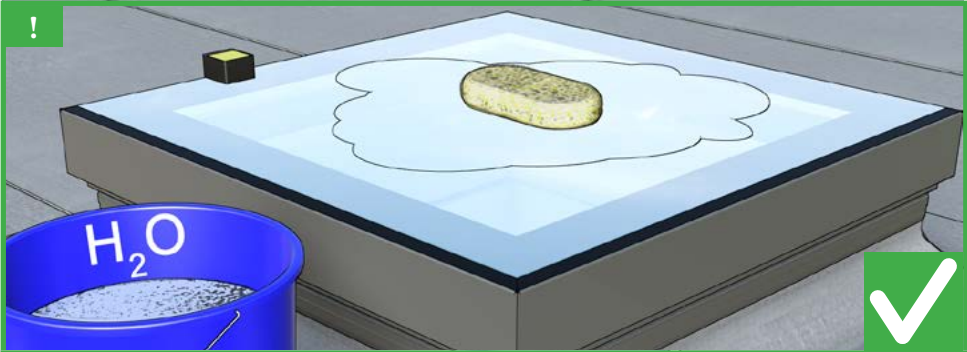



1 x YEAR

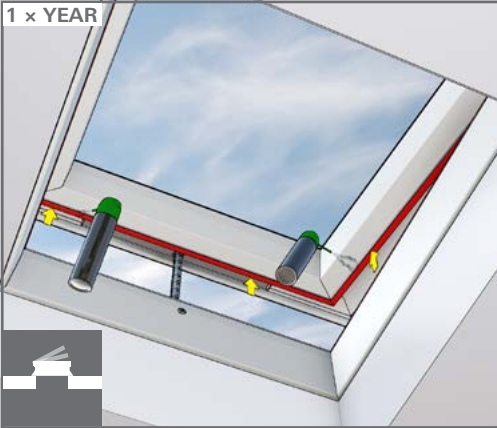

1 x YEAR

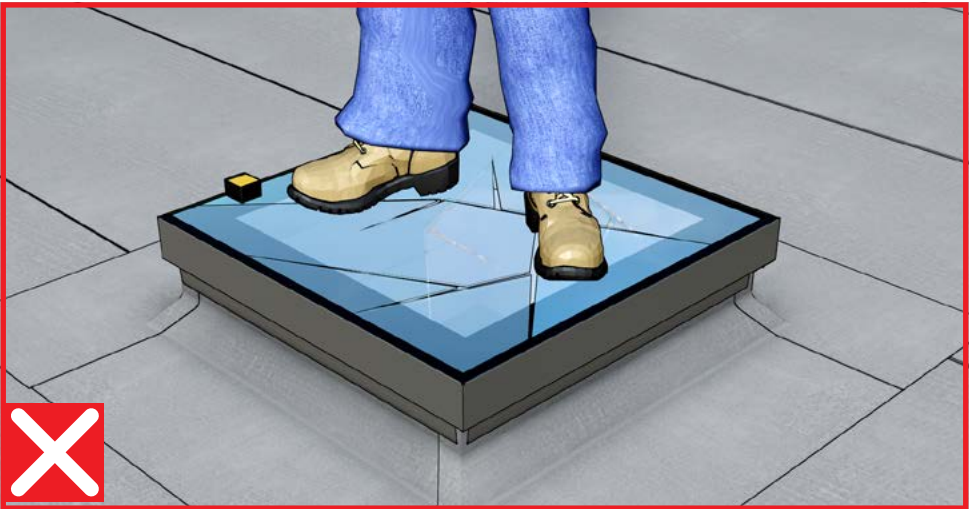
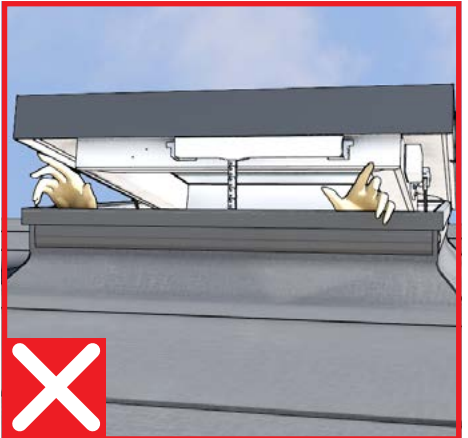
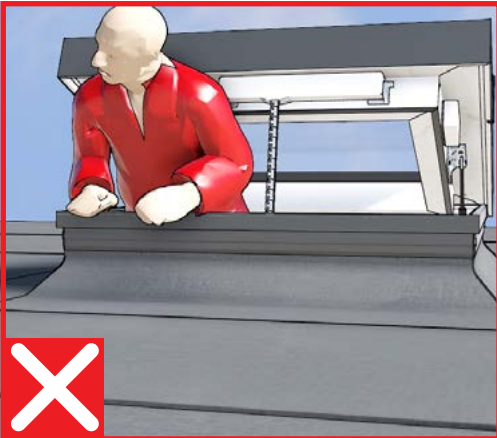
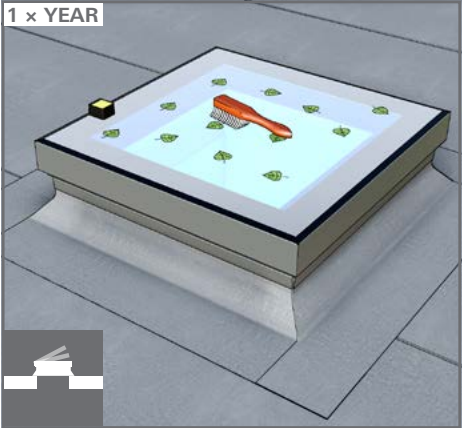

The manufacturer reserves that it will not incur any liability for failure to comply with safety requirements and laws as well as construction law by the owner, operator, fitter and architect.