

# HI-TORQUE

## HEAVY DUTY STAINLESS STEEL HOSE CLAMPS



### HI-TORQUE STAINLESS

HI-TORQUE Heavy Duty Stainless Steel Hose Clamps have been specifically designed for tough and wire reinforced hoses and for when an extra margin of safety and reliability is required. HI-TORQUE clamps out perform nut and bolt type clamps due to their more uniform tightening which gives higher sealing pressure. They are quicker to fit, have no loose parts to lose in awkward places and require less space than any other heavy duty hose clamp. HI-TORQUE clamps also offer a larger adjustment for each size than nut and bolt clamps thus reducing inventory requirements.

### LLOYD'S REGISTER APPROVAL

JCS HI-TORQUE heavy duty hose clamps hold Lloyd's Register Type Approval for applications in the marine, offshore and industrial markets. They are specifically approved by Lloyd's Register for the critical application of sealing wet diesel exhaust hoses. Further details can be supplied on request.



### MULTI-TORQUE

We have coupled the strength of HI-TORQUE hose clamps with the convenience of being able to produce instant hose clamps to any desired diameter from a kit. MULTI-TORQUE is significantly stronger than other adjustable banding products. By simply cutting off the required length from a continuous banding roll and engaging one end of the band into each housing of the MULTI-TORQUE connector a hose clamp is made. MULTI-TORQUE banding is supplied in 10m and 30m coils. A maintenance kit is available which contains one connector and 1m coil.

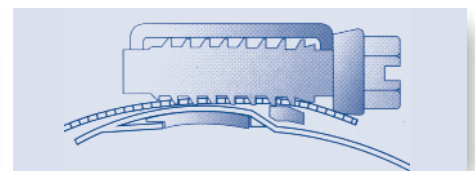
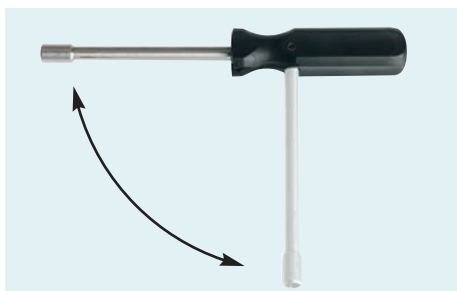

### TOOLS

For HI-TORQUE and MULTI-TORQUE a special combined screwdriver and T-bar tool is available.

### HI-TORQUE STRAPS

The strength of HI-TORQUE clamps is utilised in our straps which are used for scores of applications.

### STRAIGHT LINE HOUSING

The HI-TORQUE design has a unique 'Straight Line' housing, which ensures that every thread of the screw is fully engaged with the band. This special feature together with a high tensile band and hardened rolled thread screw means that HI-TORQUE clamps have more than twice the strength of ordinary worm drive hose clips.

HI-TORQUE

## TECHNICAL SPECIFICATION

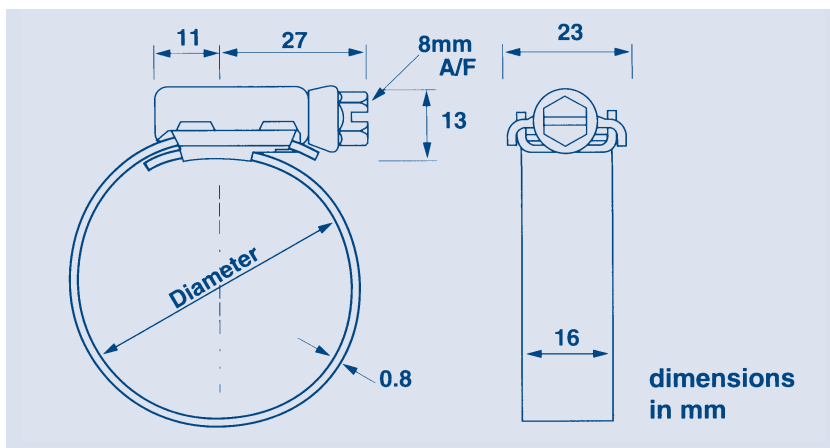

### Material Specification

Type HTM All parts BS304 - EN1.4301

Type HTJ All parts BS316 - EN1.4401

Band Tensile strength = 1150 N/mm<sup>2</sup> approx (75 tons/in<sup>2</sup>)

Recommended Setting Torque = 15 Nm (130 lb.in)

## HI-TORQUE BAND EDGES

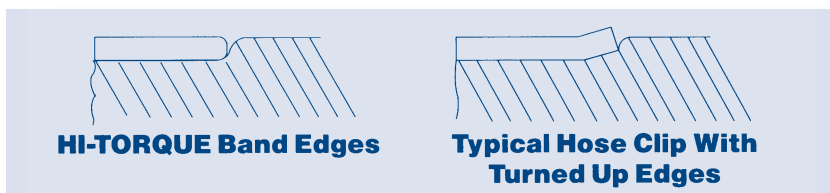

All HI-TORQUE Stainless hose clips have fully rounded edges to give the best possible protection to the hose.

## HI-TORQUE STRAPS

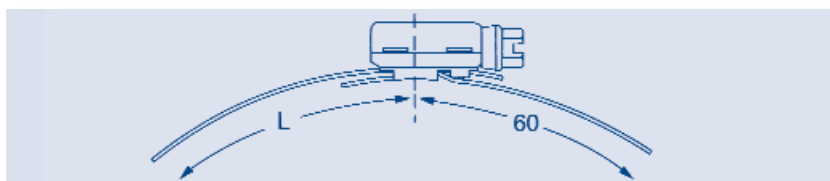

Strap Size	Linear Adjustment	Dia Adjustment	Length L
0	62	20	100
1	94	30	136
2	125	40	164

## MULTI-TORQUE

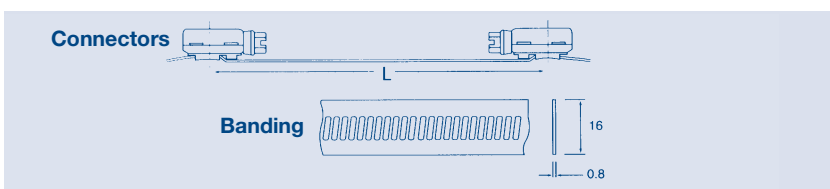

## STANDARD RANGE

size	diameter mm	diameter ins	box qty
27	20 - 27	3/4 - 1 1/8	100
30	20 - 30	3/4 - 1 1/4	100
35	20 - 35	3/4 - 1 3/8	100
40	25 - 40	1 - 1 5/8	100
(45)	25 - 45	1 - 1 3/4	100
50	30 - 50	1 1/4 - 2	100
60	40 - 60	1 5/8 - 2 3/8	100
(65)	45 - 65	1 3/4 - 2 1/2	100
70	50 - 70	2 - 2 3/4	100
80	60 - 80	2 3/8 - 3 1/8	100
90	70 - 90	2 3/4 - 3 1/2	100
(95)	75 - 95	3 - 3 3/4	100
100	80 - 100	3 1/8 - 4	100
(115)	85 - 115	3 3/8 - 4 1/2	50
120	90 - 120	3 1/2 - 4 3/4	50
140	110 - 140	4 3/8 - 5 1/2	50
160	130 - 160	5 1/8 - 6 1/4	50
180	150 - 180	5 7/8 - 7	50
200	170 - 200	6 3/4 - 7 7/8	25
220	190 - 220	7 1/2 - 8 5/8	25
240	210 - 240	8 1/4 - 9 1/2	25
260	230 - 260	9 - 10 1/4	25
280	250 - 280	9 7/8 - 11	25
300	270 - 300	10 5/8 - 11 3/4	25
320	290 - 320	11 3/8 - 12 1/2	25
340	310 - 340	12 1/4 - 13 3/8	25
360	330 - 360	13 - 14 1/8	25
380	350 - 380	13 3/4 - 15	25
400	370 - 400	14 1/2 - 15 3/4	25
420	390 - 420	15 3/8 - 16 1/2	25
440	410 - 440	16 1/8 - 17 1/4	25
460	430 - 460	17 - 18 1/8	25
480	450 - 480	17 3/4 - 18 7/8	25
500	470 - 500	18 1/2 - 19 5/8	25

( ) = Not required for a complete range but useful intermediate sizes for popular hoses. Larger diameter and clamps with greater adjustment to order.

## PACKAGING

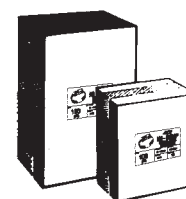

### BULK PACKS

- All sizes of HI-TORQUE are supplied in bulk packs



MULTI-TORQUE Banding is supplied in 1m, 10m and 30m lengths. Other lengths of connectors are available to special order.



Part No	Length 'L'	Box Qty
MTC150	150mm	10
MTC300	300mm	25
MTC350	350mm	25
MTC450	450mm	25