



Datasheet

Features	
Lock	Yes
LED Light	Yes
Battery Backup for Controller, 48h	Yes
Safety Thermostat	Yes
Porthole	Yes - Ø 20mm
Dry Contact	Yes
Reference bottle	Yes
Door	Solid
Door Features	Automatic: Closure < 90° Hold > 90°
Door Reversibility	Yes

Construction	
Outer Dimensions, HxWxD	2002x595x642
Inner Dimensions, HxWxD	1827x475x495
Weight Gross/Net, kg	88 / 74
Material Inner Cabinet	ABS
Material Outer Cabinet	Painted Steel
Insulation Thickness, mm	50
Insulation Type	Polyurethane with Cyclopentane
Air Distribution	Dynamic
Mobility	Standard: Adjustable Feet Option: Castors
Refrigerant, Type / gram	R600a / 60
Variable Speed Compressor	Yes - Adaptive Cooling Technology
Number of Probes	4

Controller & Alarms	
Controller	i-Care, Touch screen
Controller language	EN, DE, FR
USB Connection	Yes
Logging	Data, Alarms & Events
Temperature Graph	Yes
High/Low Temp. Alarm	Yes
Open Door Alarm	Yes
Probe Failure Alarm	Yes
Power Failure Alarm	Yes

VESTFROST
SOLUTIONS



Protection for storage
CE II 3G nA IIB T6

+20°C
+2°C

R-427i

Biomedical Refrigerator

Adaptive Cooling Technology™

Info center



Complexity made simple

Storage	
Volume, Gross/net, L	427 / 361
Shelves, Full/half	5 / 1
Shelf material	Perforated Alu
Max Loading pr. Shelf, kg	20

Performance & Operation	
Temperature Range, C°	+2 to +20
Voltage, V	220
Frequence, Hz	50 / 60
Max Ambient, °C	35
Max Humidity, °C	75
Noise, dB	40
Energy Consumption, kWh / 24h	0,4
Instant Power Consumption	PD 0,075 / Stable 0,025
Heat Rejection	61
K-Value	0,44
Defrost	Automatic



Temperature Mapping

Test overview

Test type	15-point test
Test environment	Controlled conditions, empty cabinet
Ambient temperature	20°C
Humidity	60%
Set-point	5°C
Sensors used	25gr tinned brass formed as a cylinder with a diameter of 15,2mm
Installation	Appliance installed according to instruction manual conditions
Refrigerant	R600a

Sensor position

Front View

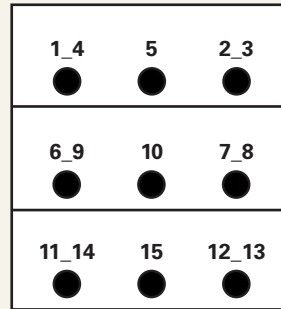

Top View

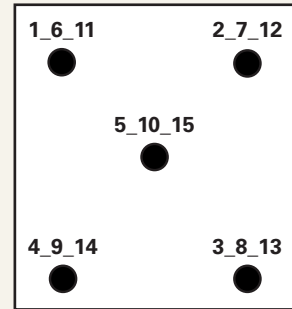

Sensor temperature

Sensor position	P1	P2	P3	P4	P5	P6	P7	P8	P9	P10	P11	P12	P13	P14	P15
Max.	5,9	5,7	5,9	6,2	5,8	3,8	4,4	4,7	4,3	4	4,8	5	5,3	5,3	4,9
Avg.	5,8	5,6	5,8	6,1	5,7	3,4	4	4,6	4,1	3,7	4,6	4,8	5,1	5,2	4,8
Min.	5,7	5,5	5,7	6,1	5,6	3,1	3,8	4,5	3,9	3,5	4,5	4,7	5	5,1	4,7

Cyclic operation

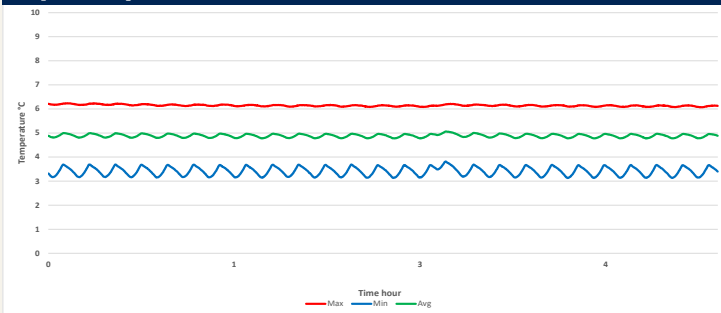

Warm up & pull down

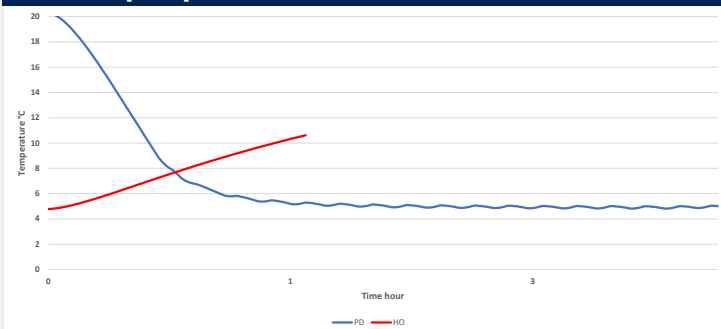

Typical performance data

Avg. cabinet temperature	4,9°C
Uniformity	+/- 1,4°C
Stability in avg.	0,3°C
1 min. door open recovery to 6°C avg. temperature	10 min.
Cycle rate on/off	6,5 / 4,4 min.
Duty cycle	59%
Energy consumption	0,438 kWh/day
Pull down time to 6°C avg. temperature	58 min.
Hold over time from 5°C to 10°C	90 min.
Sample temperature does not exceed	8°C
Heat rejection	61 W



Dimensions

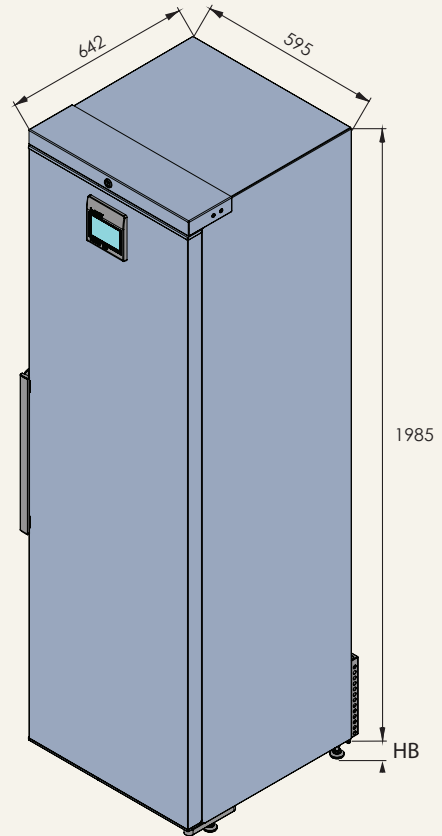
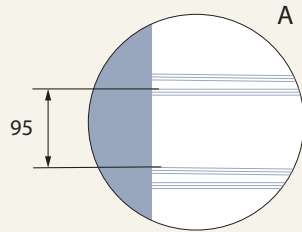
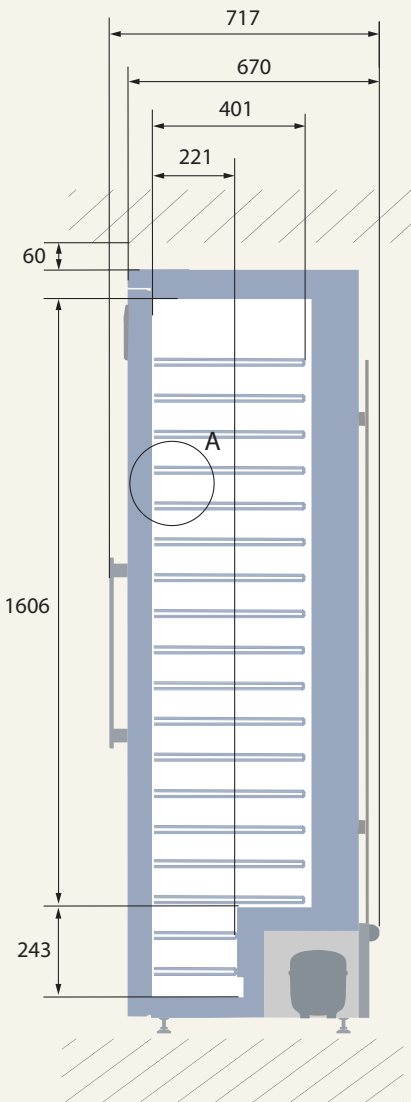
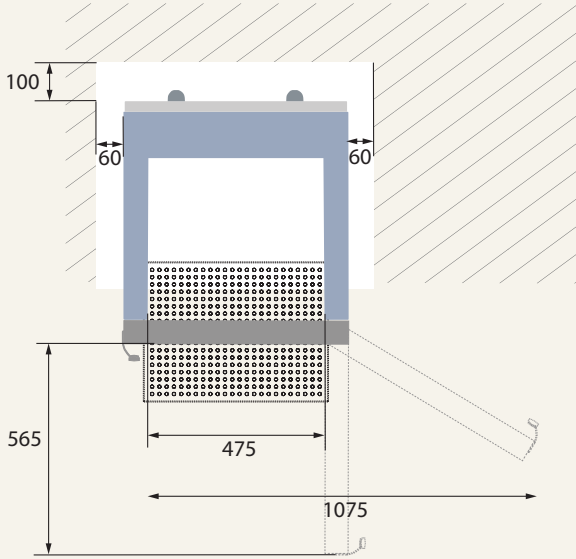

All dimensions in milimeter

HB: Height of base (HB is ajustastable when given value is xx-xx)

