

# Installatie Handleiding

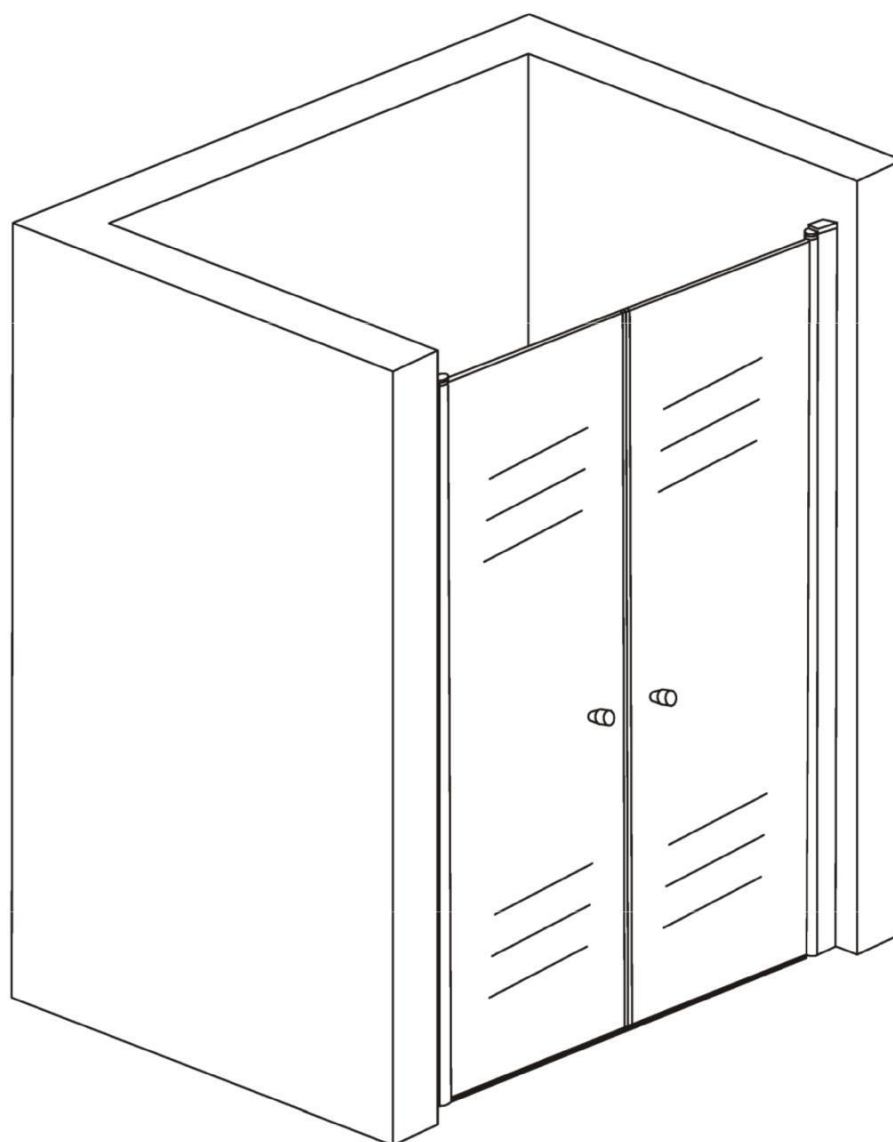

3571/3572/3573/3574/3575/3576/3577  
3578/3579/3580/3581/3582/3583/3584

**RoHS**   **ISO9001:2000**

## Benodigde gereedschappen

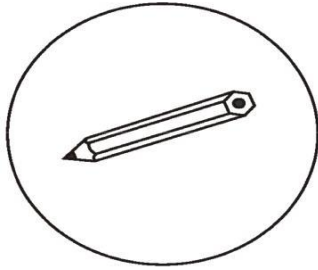

Potlood

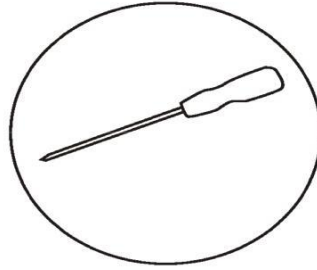

Kruis schroevendraaier

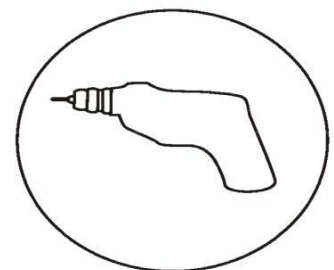

Boormachine

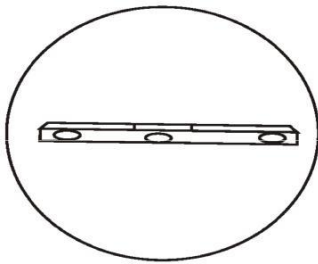

Waterpas

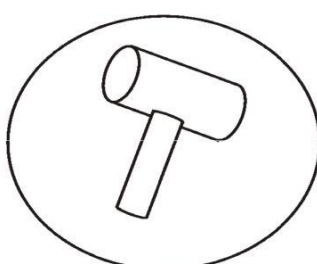

Rubber hamer

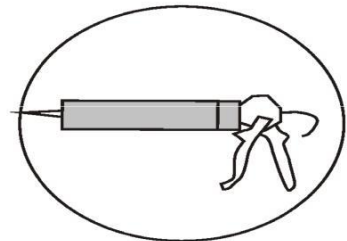

Siliconen

## Onderdelen lijst

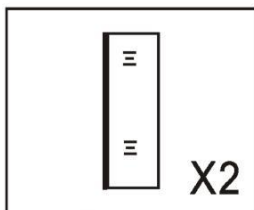

Glass

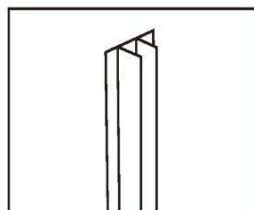

Wall profile

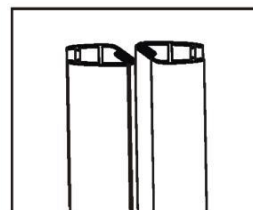

CT-6BMX90

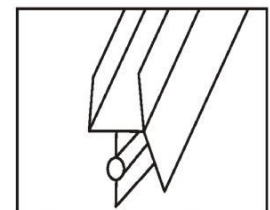

CT-6YXJT-029

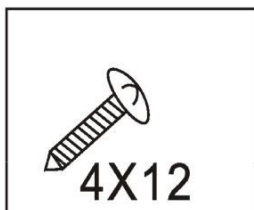

Screw

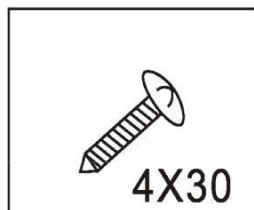

Screw

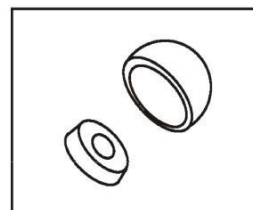

PJ-4553

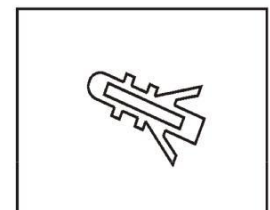

Expand tube

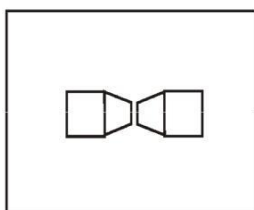

LS-1201

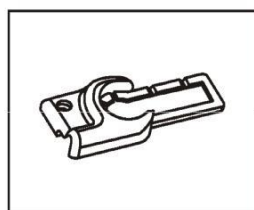

Aluminum  
bottom bar

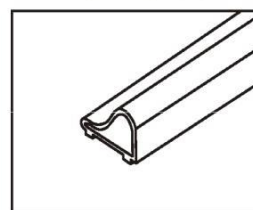

PJ-4644

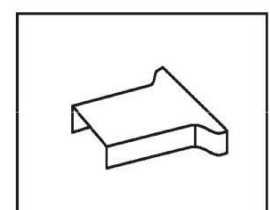

PJ-4643

1. Plaats het muurprofiel verticaal tegen de muur en gebruik een waterpas
2. Markeer de boorgaten
3. Boor de merktekens en plaats de pluggen
4. Schroef de profielen aan de muur

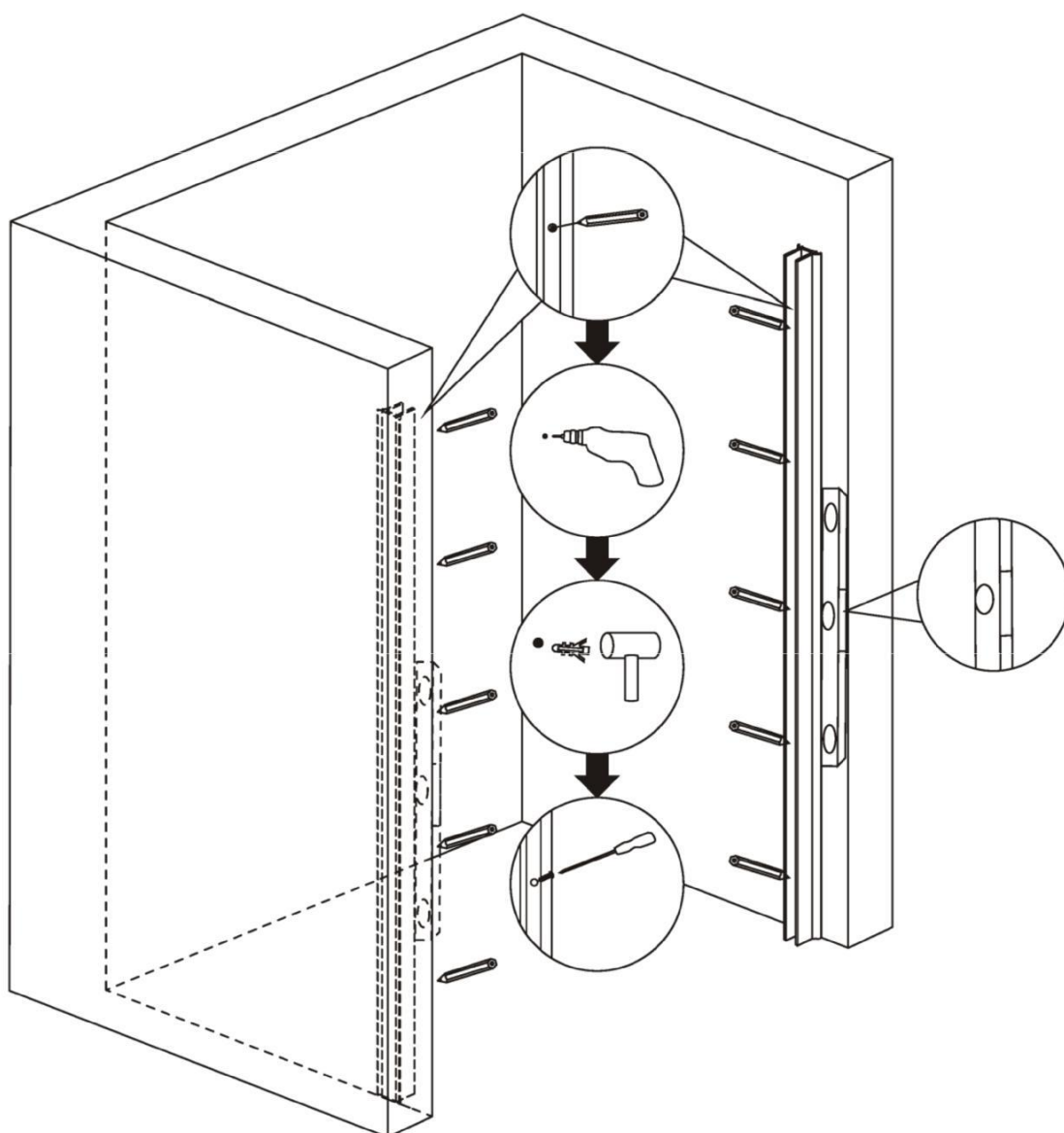
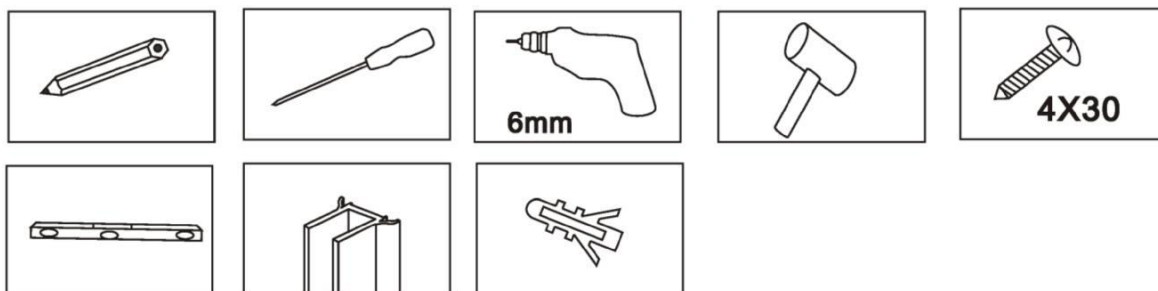

Bevestig de deuren en de magnetische strips zoals afgebeeld. Laat de magnetische strip naar de ingang uitsteken, de magnetische strips worden van de bovenkant naar beneden geduwd. Als de magnetische strip zo zijn afgesteld dat er geen ruimte is tussen de voorste en de achterste magnetische strip, knip je de strips indien nodig.

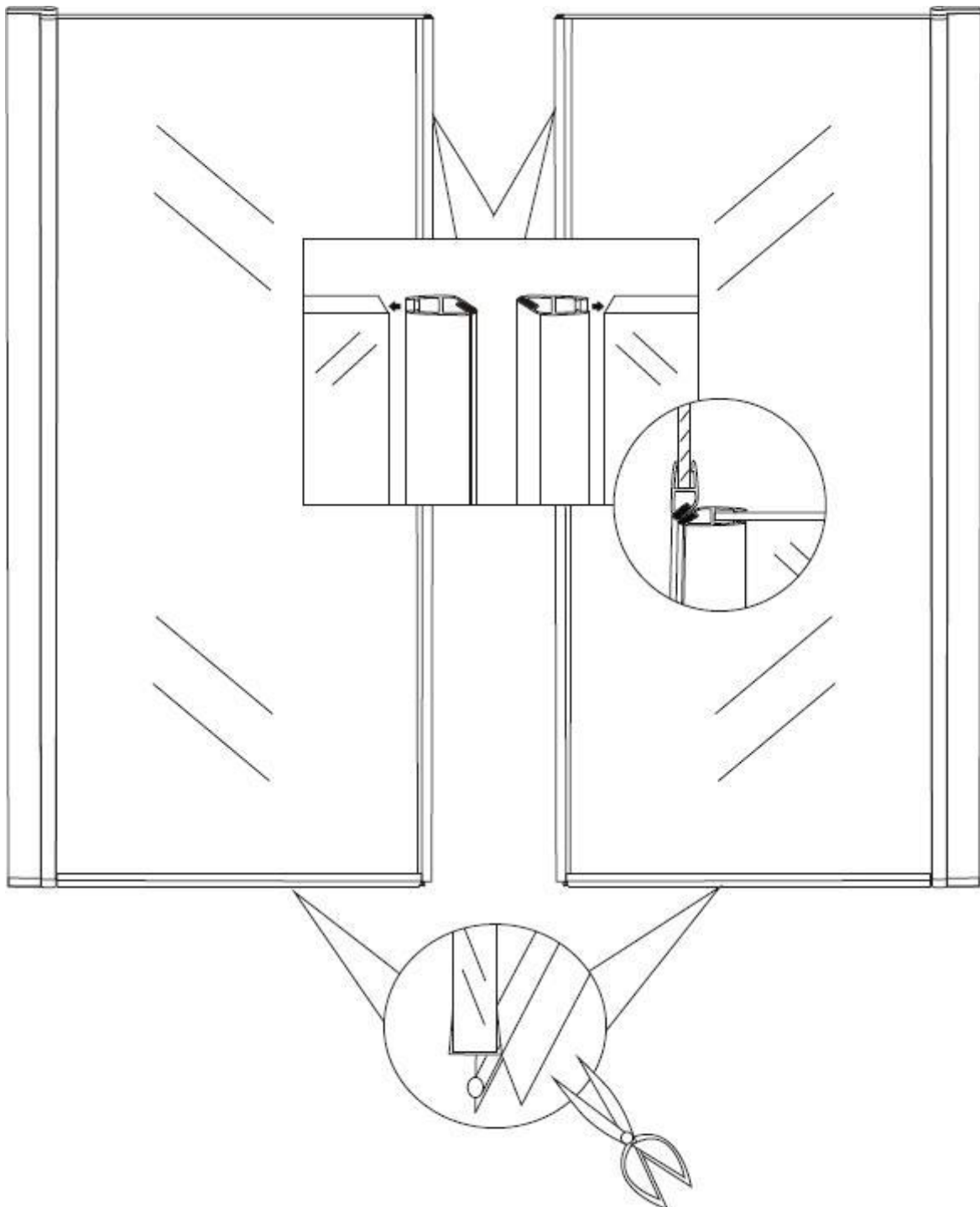

1. Lijm de waterlijst, injecteer siliconen onder de waterlijst en de aluminium bottom bar, niet vastschroeven zoals weergegeven
2. Steek beide deur glazen voorzichtig in de muurprofielen en til de panelen op
3. Laat de deur glazen voorzichtig in de daarvoor bestemde houder van de adapters zakken

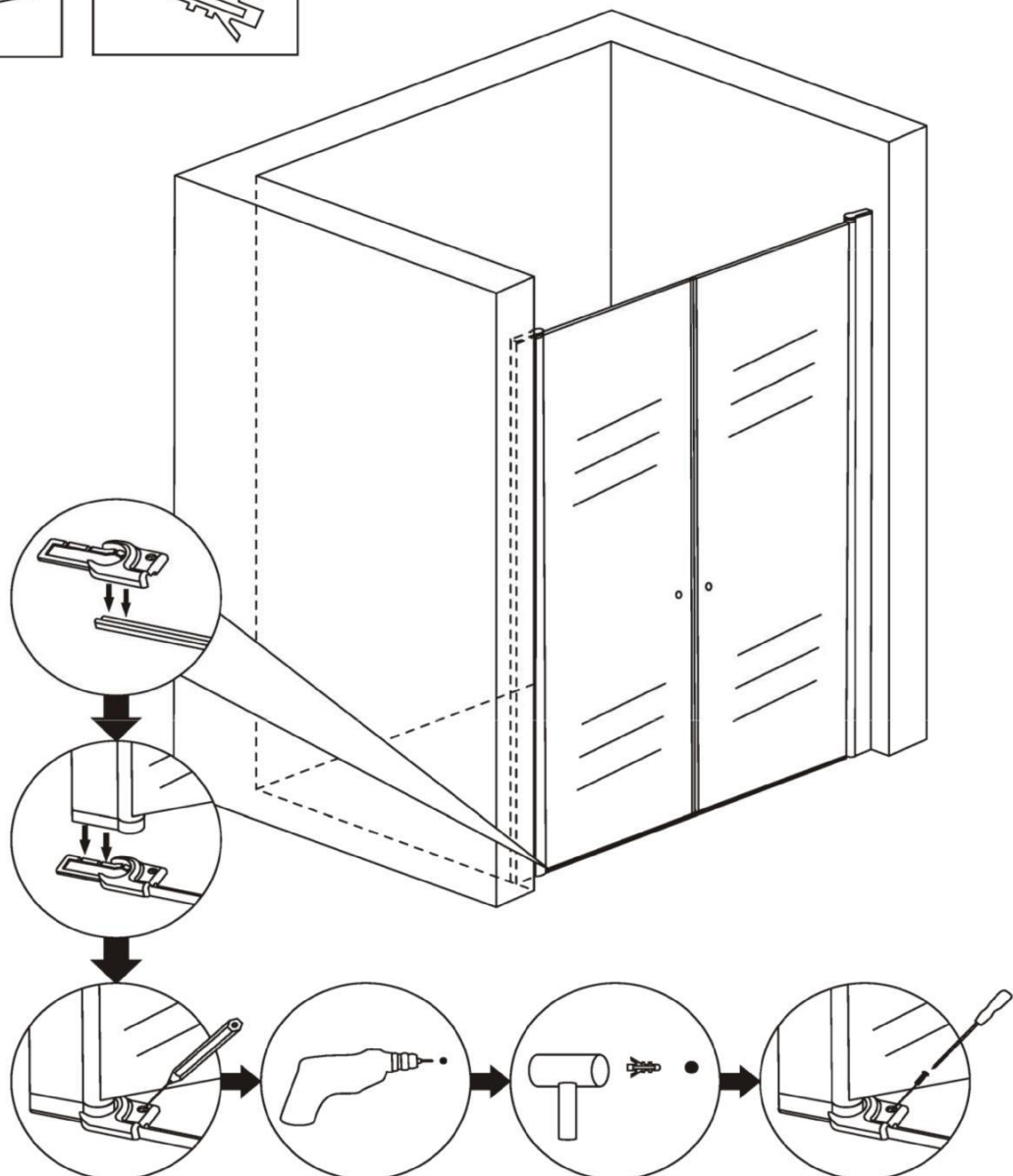
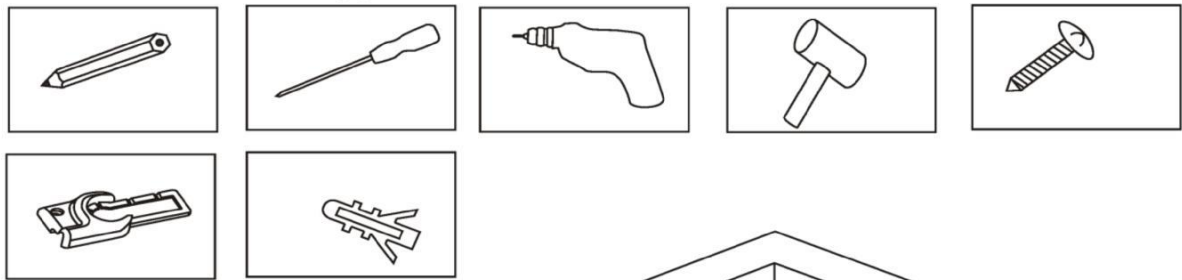

1. Boor door de muurprofielen op de daarvoor bestemde plaatsen en bevestig de deurglazen met de meegeleverde schroeven
2. Bevestig vervolgens de bovenste profielafdekkingen en doppen om de schroeven af te dekken
3. Schroef de deurgrepen vast
4. Dicht de waterlijst en, indien nodig, de muurprofielen van binnen en buiten af met siliconen

