

Installatie handleiding

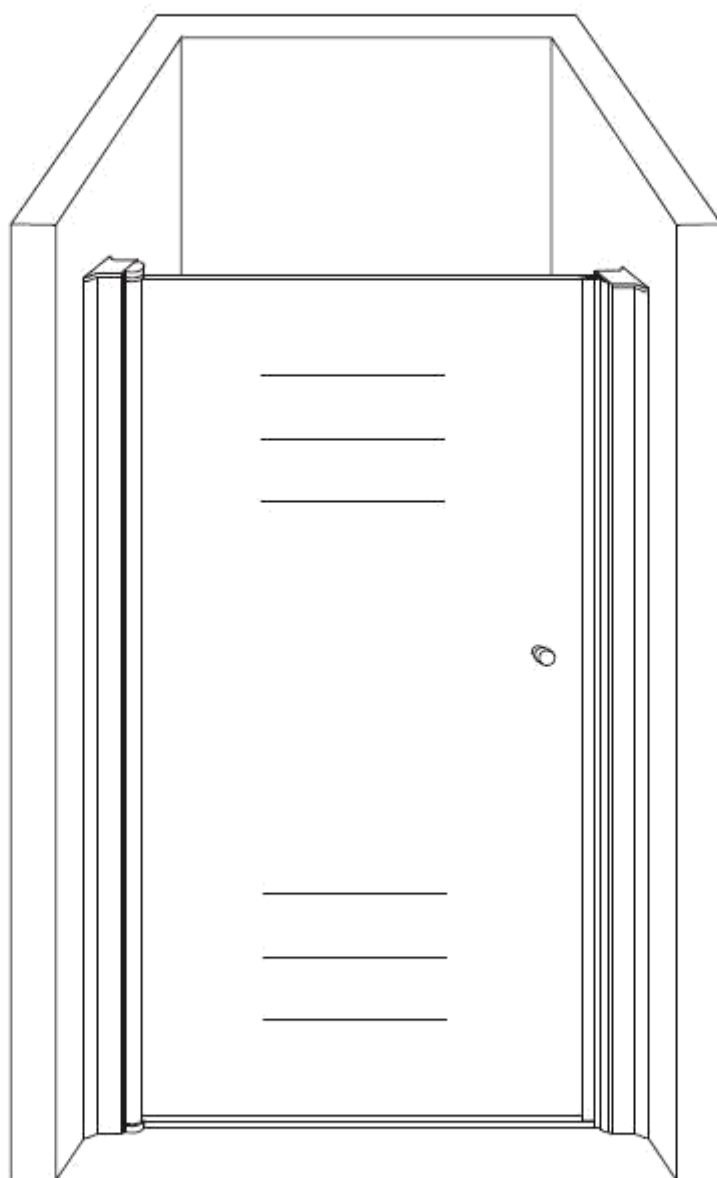

3591/3592/3593/3594/3595/3596

RoHS **CE** **ISO 9001-2008**

Benodigde gereedschap

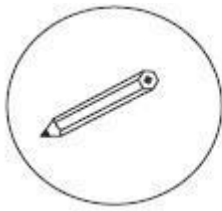

Stift

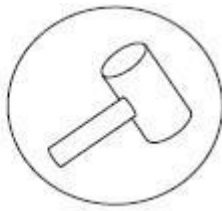

Hamer

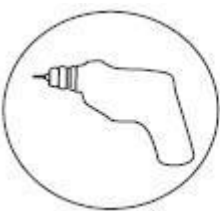

Boor

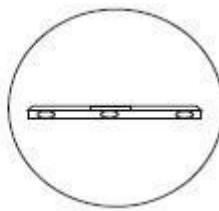

Waterpas



Schroevendraaier



Inbussleutel

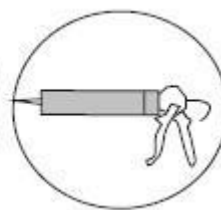

Silicone

Onderdelenlijst

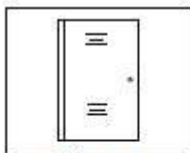

Glass

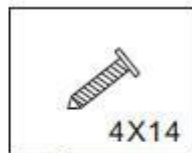

4X14
Screw



4X30
Screw

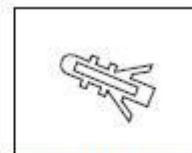

Expand tube

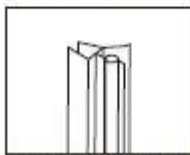

water-proof gasket

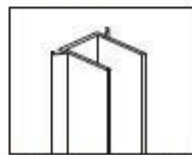

Wall profile

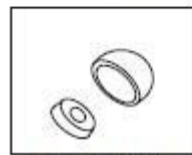

PJ-4553

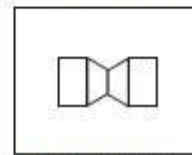

LS-1201

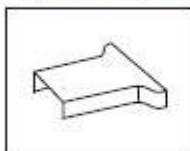

PJ-4643

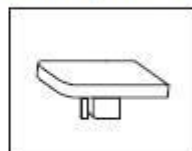

PJ-4509



CT-8BMX90/
CT-BCT-005

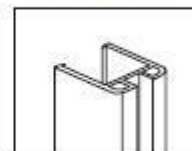

Wall profile

1. Plaats de muurprofielen verticaal op de beoogde locatie. Gebruik een waterpas om te helpen
2. Markeer de boorgaten
3. Boor op de markering (6mm) en steek de pluggen in de muur
4. Schroef vervolgens de muurprofielen vast aan de muur

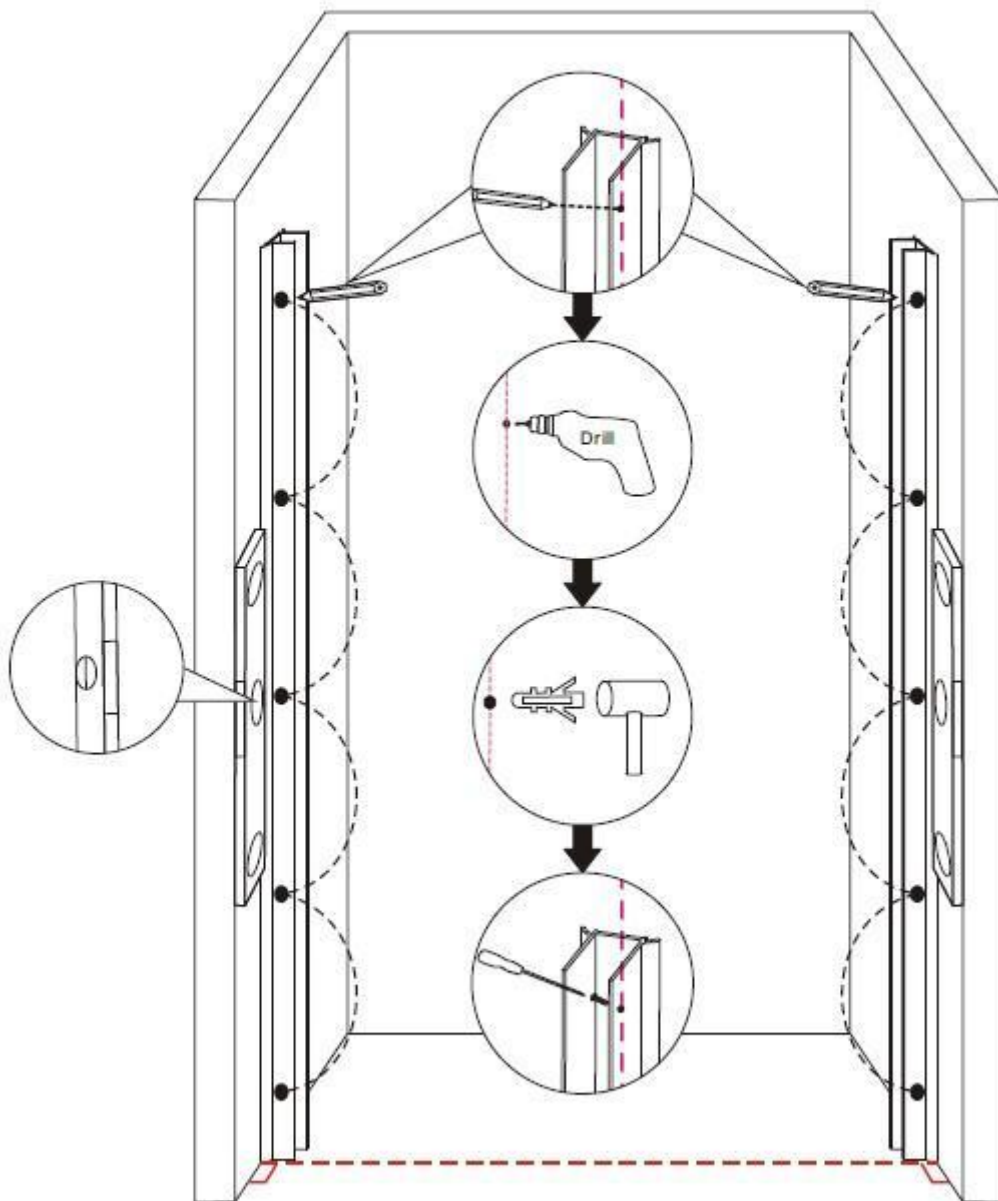
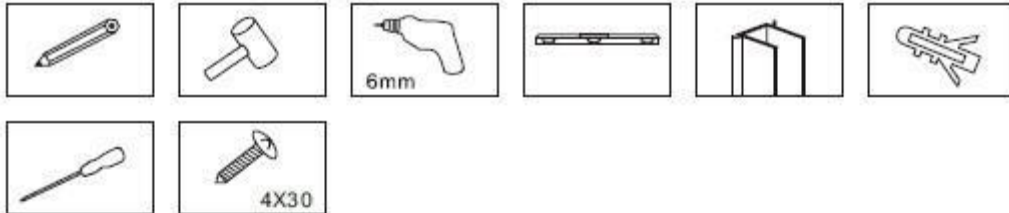

1. Schuif het profiel in het muurprofiel
2. Plaats de magneetstrip in het profiel

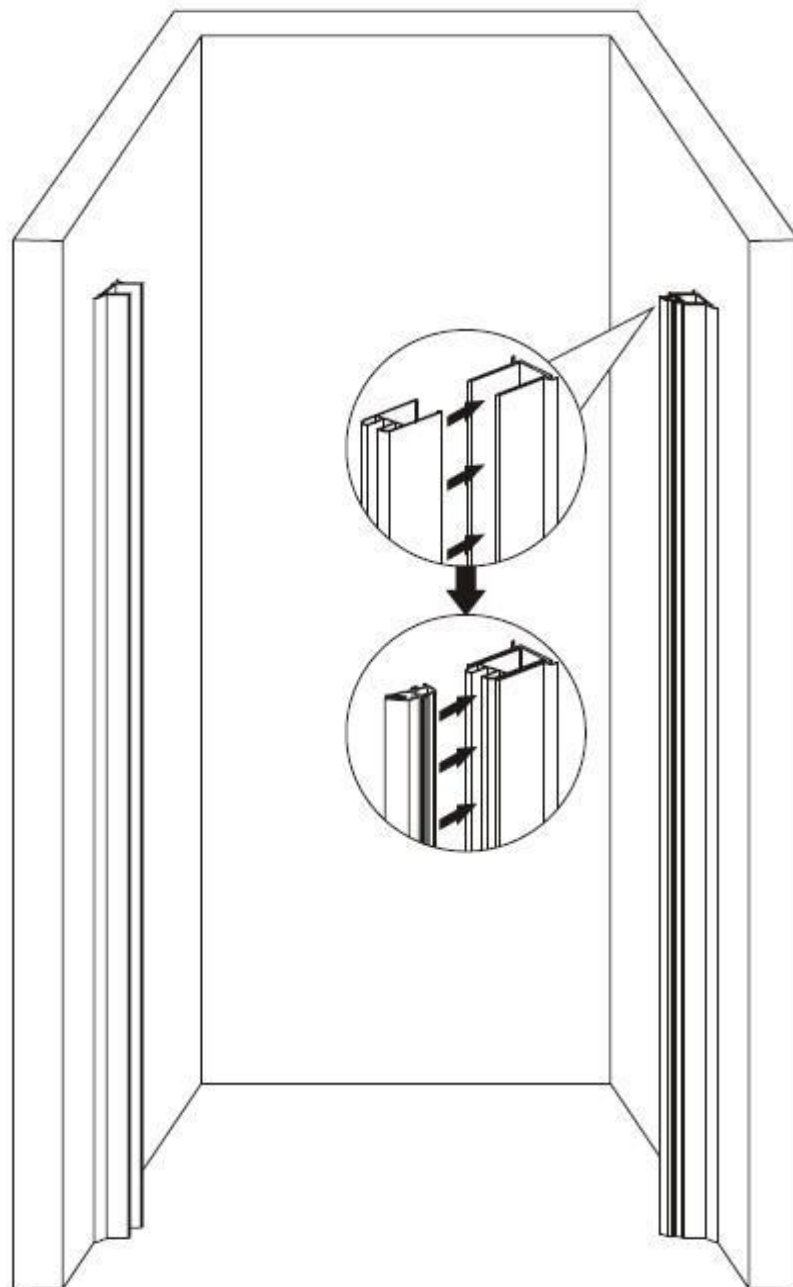
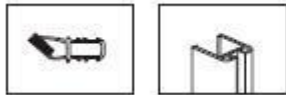

1. Bevestig de 2^{de} magneetstrip aan de nisseur
2. Monteer de onderste deurrubber, laat deze iets uitsteken en knip een hoek van 90 graden (zoals afgebeeld)
3. De magneetstrip wordt nu neergelaten om te "duwen" en te rusten om de onderste afdichting

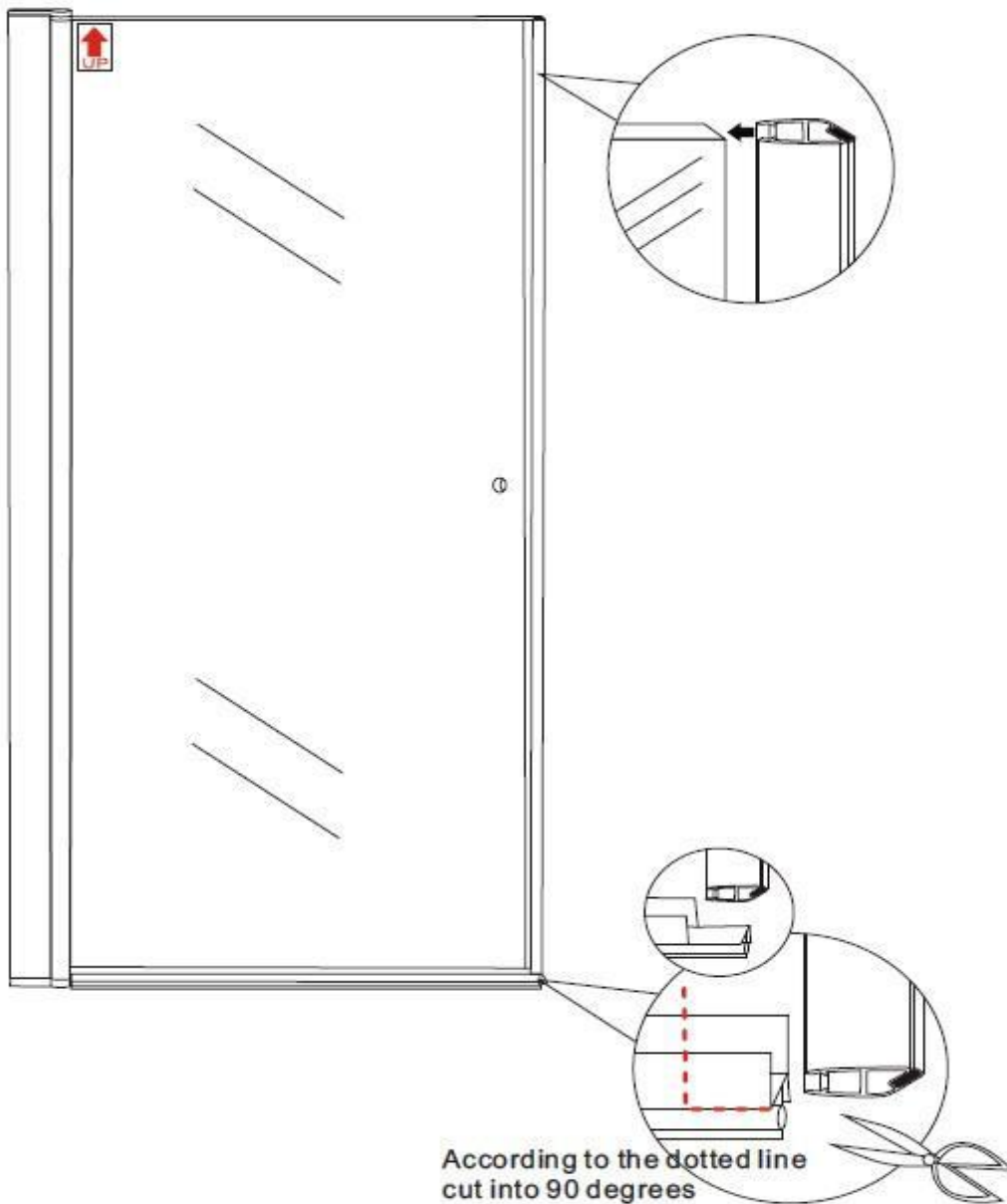

Plaats de deur voorzichtig in het muurprofiel, zorg ervoor dat deze aan beide kanten in het muurprofiel zit

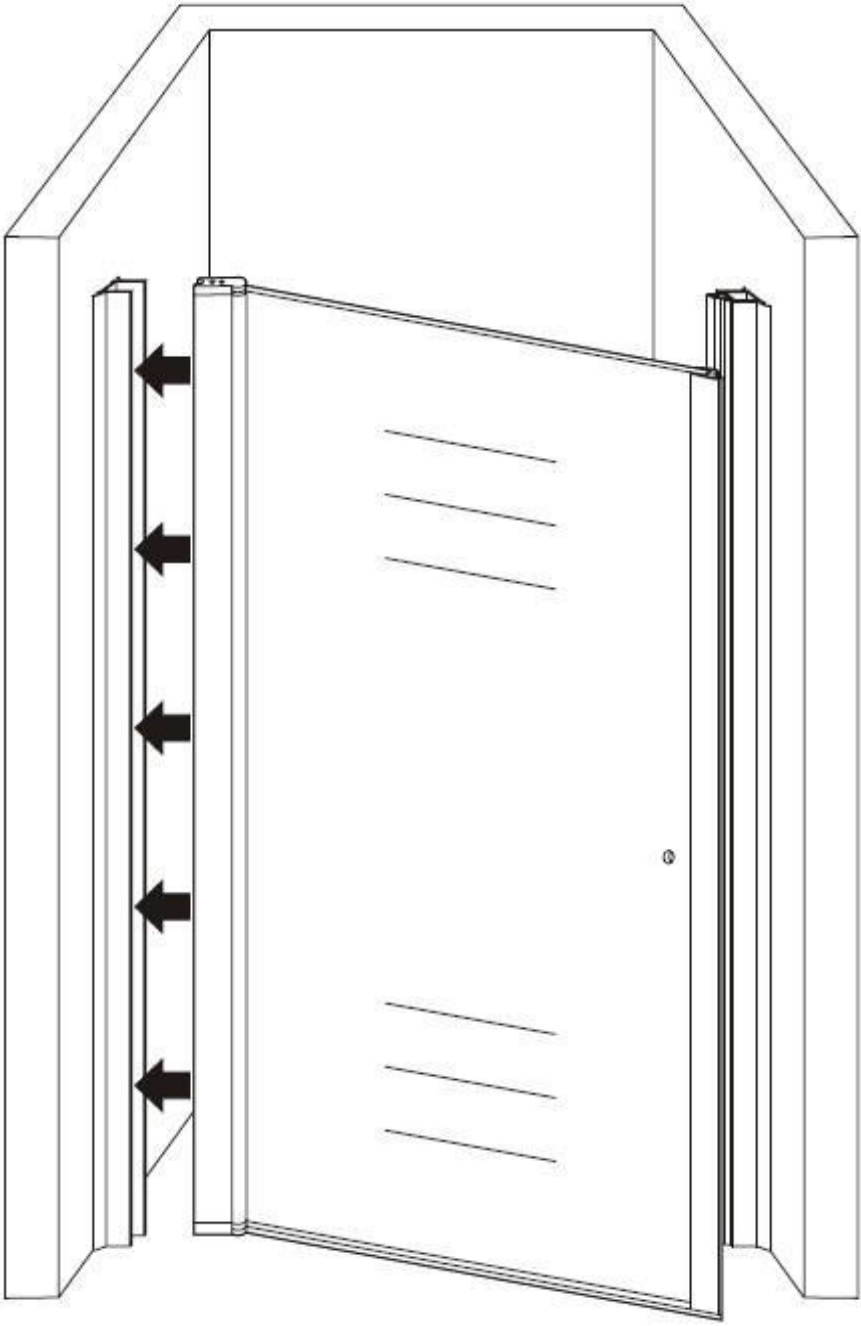

1. Gebruik de meegeleverde boor van 3 mm om op de daarvoor bestemde plaatsen te boren. Bestig de meegeleverde schroeven
2. Plaats de afdekkappen om de schroeven af te dekken

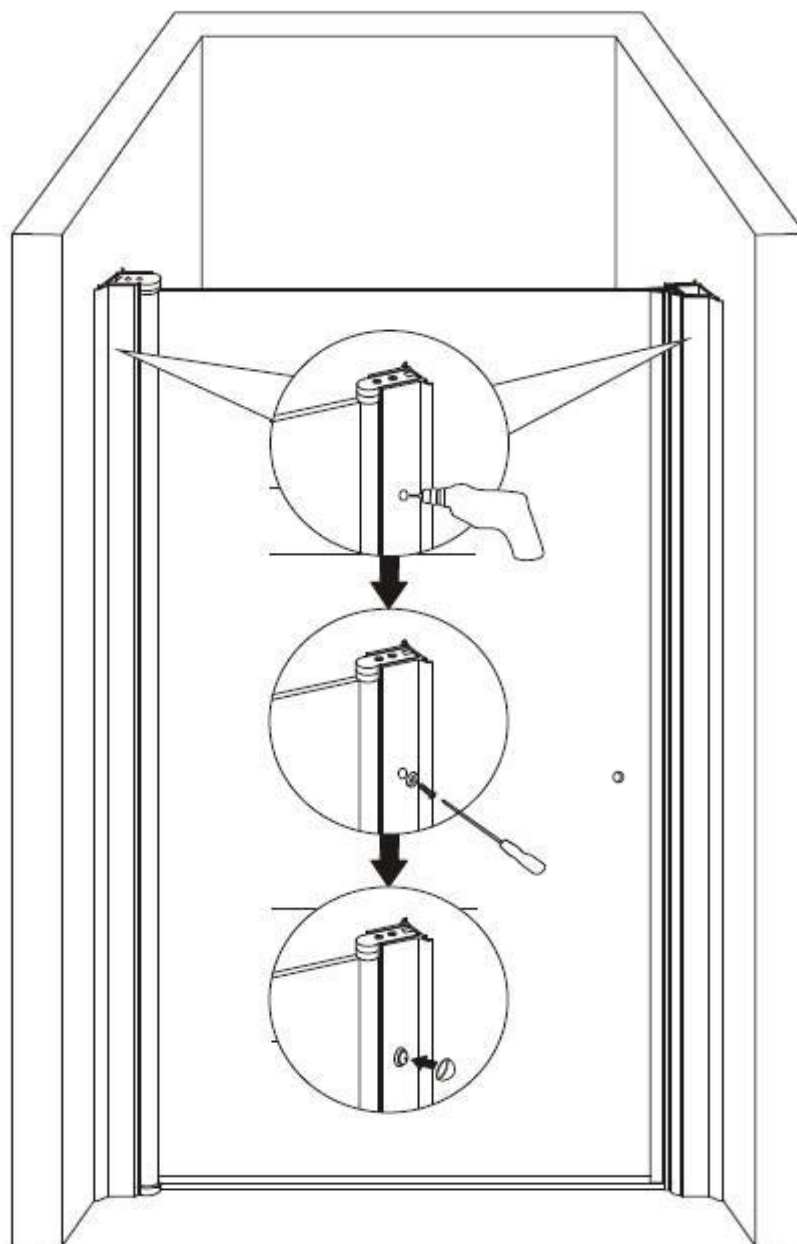
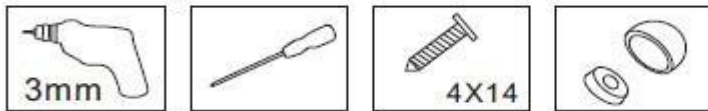

1. Bevestig de bovenste kappen
2. Installeer de deurknoppen
3. Kit de buitenkant van de douchedeur met silicone

