



WERBETECHNIK24.CH

Messesysteme



Pop-Ups

Impress Straight	12
Impress Options	14
Fabric	18
Fabric Premium	20
Magnetic	22
Magnetic Options	24
Tower	26

5 YEAR
WARRANTY
★★★★★

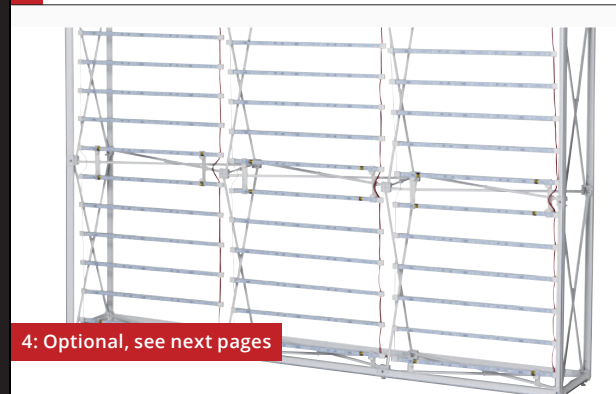
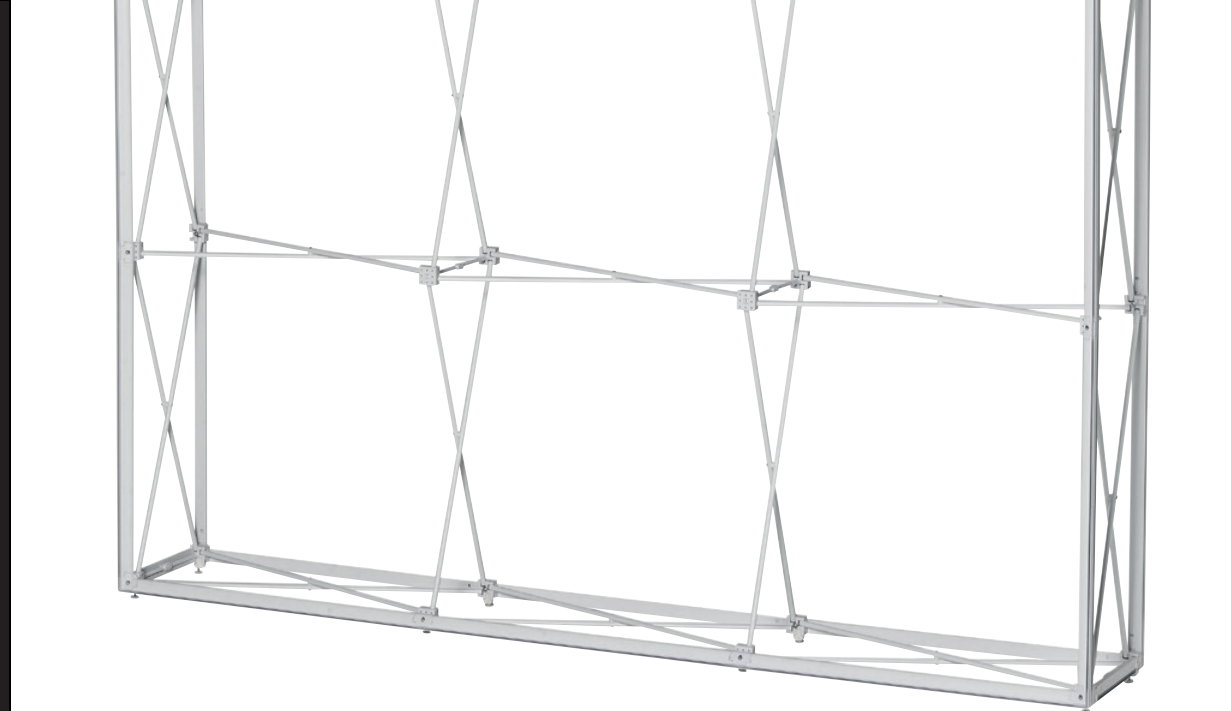

4: Optional, see next pages

5: Optional, see chapter Lighting on page 84



Important: Available in 20 sizes
Width: Between 77 and 591 cm
Height: Between 224 and 371 cm

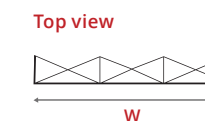

3 levels high

Art. nr.	Frame	W	H	D
IMPR13S	1 x 3	77	224	36
IMPR23S	2 x 3	151	224	36
IMPR33S	3 x 3	224	224	36
IMPR43S	4 x 3	298	224	36
IMPR53S	5 x 3	371	224	36
IMPR63S	6 x 3	444	224	36
IMPR73S	7 x 3	517	224	36
IMPR83S	8 x 3	591	224	36

All sizes in cm.

Dimensions

4 levels high

Art. nr.	Frame	W	H	D
IMPR14S	1 x 4	77	298	36
IMPR24S	2 x 4	151	298	36
IMPR34S	3 x 4	224	298	36
IMPR44S	4 x 4	298	298	36
IMPR54S	5 x 4	371	298	36
IMPR64S	6 x 4	444	298	36
IMPR74S	7 x 4	517	298	36
IMPR84S	8 x 4	591	298	36

Pop-Up Impress Straight

- EN**
- White aluminium frame with grooved bars that hold Silicone Edge Graphics (1)
 - Equipped with fixation for lighting (2)
 - Padded trolley with extra bag for storage bars (3)
 - **Optional:** LED light curtains and accessories (4)
 - **Optional:** LED or halogen lighting (5)
- DE**
- Weißer Aluminiumrahmen mit gerillten Schienen, die Silicone Edge Graphics halten (1)
 - Standardmäßig geliefert mit Befestigungssystem für die Beleuchtung (2)
 - Gepolsterter Trolley mit separater Hülle zum Aufbewahren der Stäbe (3)
 - **Optional:** LED-Lichtvorhänge und Zubehör (4)
 - **Optional:** LED- oder Halogenbeleuchtung (5)
- NL**
- Wit aluminium frame met gegroefde bars voor Silicone Edge Graphics (1)
 - Standaard voorzien van bevestigingssysteem voor verlichting (2)
 - Gevoerde trolley met losse hoes voor opbergen bars (3)
 - **Optioneel:** LED lichtgordijnen en bijbehorende accessoires (4)
 - **Optioneel:** LED of halogeenverlichting (5)
- FR**
- Cadre aluminium blanc avec barres rainurées pour Silicon Edge Graphics (1)
 - Fourni avec système de fixation pour éclairage (2)
 - Valise souple rembourée avec housse pour ranger les barres (3)
 - **Optionnel :** Rideaux lumière LED avec accessoires (4)
 - **Optionnel :** LED ou éclairage halogène (5)
- ES**
- Estructura de aluminio blanca con barras acanaladas para Silicon Edge Graphics (1)
 - Equipado con punto de fijación para iluminación (2)
 - Trolley acolchado con bolsa especial para guardar las barras (3)
 - **Opcional:** Cortinas de luz LED y accesorios (4)
 - **Opcional:** Iluminación LED o halógena (5)

Attention: See next pages for options



Feet

- EN** Easy attachable feet in 3 colours
(set of 2 pieces)
- DE** Einfach montierbare FüÙe in 3 Farben
(2 Stück)
- NL** Eenvoudig te monteren voeten in 3 kleuren
(set van 2)
- FR** Pieds en 3 couleurs simple à monter
(kit de 2 pièces)
- ES** Pies fáciles de montar y en 3 colores
(juego de 2 piezas)

Art. nr.	Product
IMPR-FTWH	Pop-Up Impress Feet White
IMPR-FTS	Pop-Up Impress Feet Silver
IMPR-FTB	Pop-Up Impress Feet Black

3 levels high

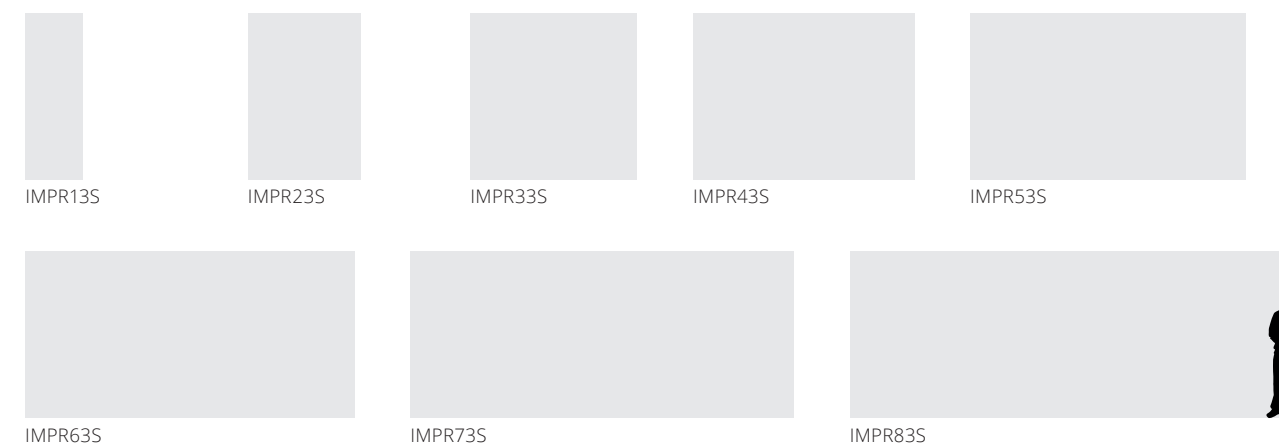

4 levels high

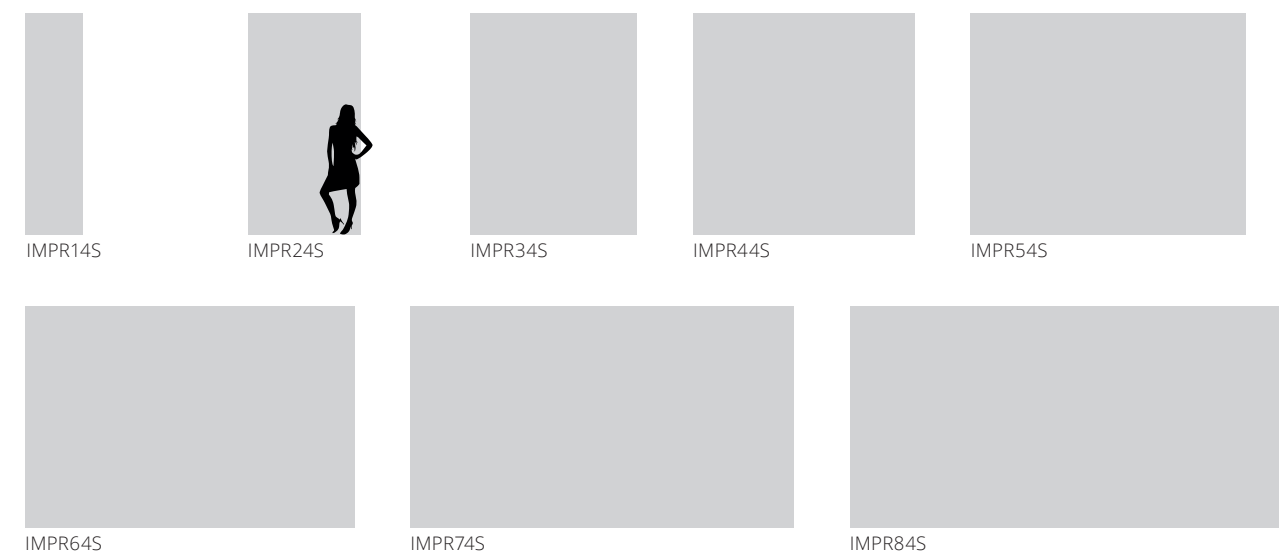

5 levels high

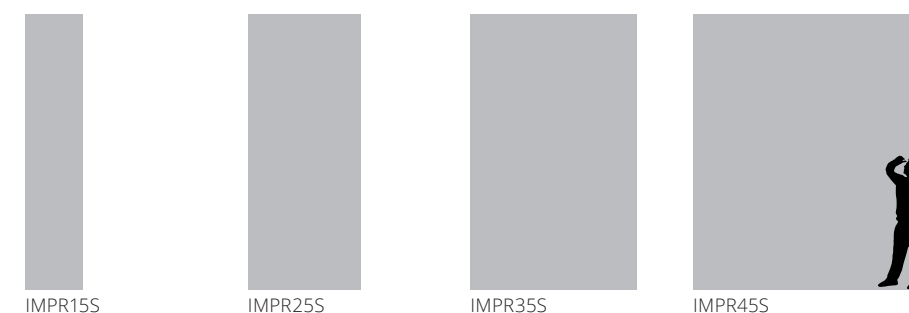

Sizes

Extra Bars for Backside

- EN** Extra bars to attach graphic on backside frame (for top and bottom)
- DE** Extra Schienen um den Druck an der Rückseite zu befestigen (für Oberseite und Unterseite des Rahmens)
- NL** Extra bars om print aan achterkant te bevestigen (voor boven- en onderkant frame)
- FR** Barres additionnelles de fixation du visuel au verso de la structure (pour le haut et le bas)
- ES** Barras adicionales para fijar el gráfico en la parte trasera de la estructura (parte superior e inferior)



3 levels high

Art. nr.	Product
IMPR13S-BARB	2 bars for backside
IMPR23S-BARB	4 bars for backside
IMPR33S-BARB	6 bars for backside
IMPR43S-BARB	8 bars for backside
IMPR53S-BARB	10 bars for backside
IMPR63S-BARB	12 bars for backside
IMPR73S-BARB	14 bars for backside
IMPR83S-BARB	16 bars for backside

4 levels high

Art. nr.	Product
IMPR14S-BARB	2 bars for backside
IMPR24S-BARB	4 bars for backside
IMPR34S-BARB	6 bars for backside
IMPR44S-BARB	8 bars for backside
IMPR54S-BARB	10 bars for backside
IMPR64S-BARB	12 bars for backside
IMPR74S-BARB	14 bars for backside
IMPR84S-BARB	16 bars for backside

5 levels high

Art. nr.	Product
IMPR15S-BARB	2 bars for backside
IMPR25S-BARB	4 bars for backside
IMPR35S-BARB	6 bars for backside
IMPR45S-BARB	8 bars for backside

Blockout Film Backside

- EN**
- Seamless blockout film with reflective backing for backside frame
- DE**
- Nahtlose lichtblockierende Blockout-Folie mit reflektierendem Trägermaterial für Fensterrückseite
- NL**
- Naadloze block-out film met een reflecterende backing voor achterkant frame
- FR**
- Block-out film sans coutures avec support réfléchissant pour verso du cadre
- ES**
- Película de bloqueo sin costuras y con refuerzo reflectante para la parte posterior del cuadro



3 levels high

Art. nr.	Product
IMPR13S-BOB	Block-out Film 1 x 3
IMPR23S-BOB	Block-out Film 2 x 3
IMPR33S-BOB	Block-out Film 3 x 3
IMPR43S-BOB	Block-out Film 4 x 3
IMPR53S-BOB	Block-out Film 5 x 3
IMPR63S-BOB	Block-out Film 6 x 3
IMPR73S-BOB	Block-out Film 7 x 3
IMPR83S-BOB	Block-out Film 8 x 3

4 levels high

Art. nr.	Product
IMPR14S-BOB	Block-out Film 1 x 4
IMPR24S-BOB	Block-out Film 2 x 4
IMPR34S-BOB	Block-out Film 3 x 4
IMPR44S-BOB	Block-out Film 4 x 4
IMPR54S-BOB	Block-out Film 5 x 4
IMPR64S-BOB	Block-out Film 6 x 4
IMPR74S-BOB	Block-out Film 7 x 4
IMPR84S-BOB	Block-out Film 8 x 4

5 levels high

Art. nr.	Product
IMPR15S-BOB	Block-out Film 1 x 5
IMPR25S-BOB	Block-out Film 2 x 5
IMPR35S-BOB	Block-out Film 3 x 5
IMPR45S-BOB	Block-out Film 4 x 5

LED Light Set for Backlit Display

- EN**
- Separate LED light curtains for backlit display
 - Including 200, 240 or 320 watt transformer
 - Including silicone edged block-out film for bottom, top and sides
- DE**
- Separate LED-Lichtvorhänge für hintergrundbeleuchtetes Display
 - Inklusive 200, 240 oder 320 Watt Transformator
 - Inklusive Blockout-Folie mit Silikonabschluss für Unterseite, Oberseite und Seitenflächen
- NL**
- Losse LED lichtgordijnen voor backlit display
 - Inclusief 200, 240 of 320 watt transformator
 - Inclusief silicone edged block-out film voor bodem, top en zijanten
- FR**
- Rideaux lumière LED pour backlit display
 - Avec transformateur de 200, 240 ou 320 watt
 - Avec silicone edged block-out film pour fond, haut et côtés
- ES**
- Cortinas de luz LED opcionales para obtener un display iluminado
 - Incluye transformador de 200, 240 o 320 watt
 - Incluye Blockout film con bordes de silicona para las partes inferior, superior y laterales del display

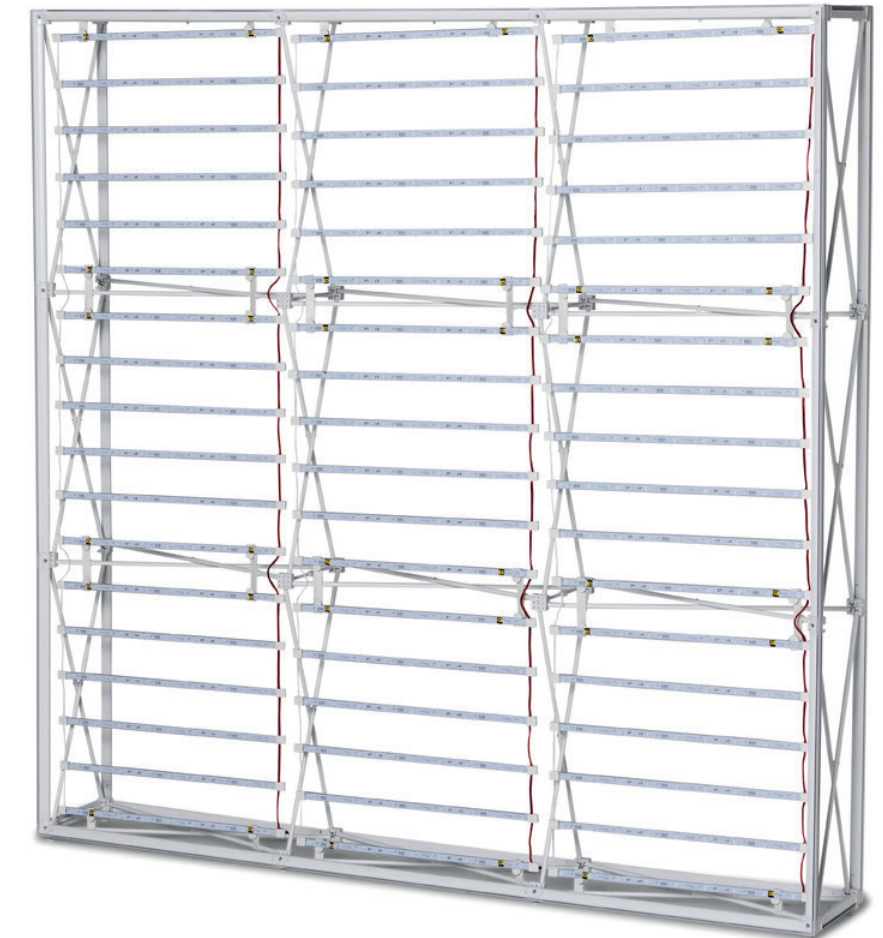

3 levels high

Art. nr.	Product
IMPR13S-LEDSET	LED Light Set 1 x 3
IMPR23S-LEDSET	LED Light Set 2 x 3
IMPR33S-LEDSET	LED Light Set 3 x 3
IMPR43S-LEDSET	LED Light Set 4 x 3
IMPR53S-LEDSET	LED Light Set 5 x 3
IMPR63S-LEDSET	LED Light Set 6 x 3
IMPR73S-LEDSET	LED Light Set 7 x 3
IMPR83S-LEDSET	LED Light Set 8 x 3

4 levels high

Art. nr.	Product
IMPR14S-LEDSET	LED Light Set 1 x 4
IMPR24S-LEDSET	LED Light Set 2 x 4
IMPR34S-LEDSET	LED Light Set 3 x 4
IMPR44S-LEDSET	LED Light Set 4 x 4
IMPR54S-LEDSET	LED Light Set 5 x 4
IMPR64S-LEDSET	LED Light Set 6 x 4
IMPR74S-LEDSET	LED Light Set 7 x 4
IMPR84S-LEDSET	LED Light Set 8 x 4

5 levels high

Art. nr.	Product
IMPR15S-LEDSET	LED Light Set 1 x 5
IMPR25S-LEDSET	LED Light Set 2 x 5
IMPR35S-LEDSET	LED Light Set 3 x 5
IMPR45S-LEDSET	LED Light Set 4 x 5



1

2: Case type A, see Trolley Case on page 167

3

4: Case type B, soft bag

5: Optional, see chapter Lighting on page 84

6: Optional



Optional velcro (6)

Product Velcro Loop (soft side)
 Art. nr. VEL50L
 Width 50mm
 Length 25m

Top view

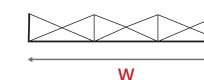

Pop-Up Fabric

EN

- 50 mm white hook velcro (hard side) (1)
- Stable mobile trolley M / L / XL (2)
- Wide wheel base with ball bearing wheels (3)
- Padded bag with braces and zipper over full length (4)
- **Optional:** LED or halogen lighting (5)
- **Optional:** Loop velcro (soft side) available (6)

DE

- 50 mm weißes Klettband (1)
- Stabiler mobiler Trolley M / L / XL (2)
- Breiter Radstand mit kugellagererten Rädern (3)
- Verstärkte Tasche mit Innenfutter und Reißverschluss über die ganze Taschenlänge (4)
- **Optional:** LED- oder Halogenbeleuchtung (5)
- **Optional:** Flauschband erhältlich (6)

NL

- 50 mm witte klittenband (haak) (1)
- Stabiele verrijdbare trolley M / L / XL (2)
- Brede wielbasis met kogelgelagerde wielen (3)
- Gevoerde tas met ritsluiting over volledige lengte (4)
- **Optioneel:** LED of halogeenverlichting (5)
- **Optioneel:** Lus klittenband (zachte kant) beschikbaar (6)

FR

- Velcro male blanc 50 mm (côté dur) (1)
- Valise de transport stable M / L / XL (2)
- Position large des roues avec roulement à billes (3)
- Sac renforcé avec doublure et fermeture éclair sur toute la longueur (4)
- **Optionnel :** LED ou éclairage halogène (5)
- **Optionnel :** Velcro femelle (côté mou) disponible (6)

ES

- Velcro de gancho blanco (cara dura) 50 mm (1)
- Trolley estable M / L / XL (2)
- Amplia distancia entre ruedas con cojinete de bolas (3)
- Bolsa acolchada y reforzada con cremallera a todo el largo (4)
- **Opcional:** Iluminación LED o halógena (5)
- **Opcional:** Velcro de bucle (cara suave) disponible (6)

	Art. nr.	Frame	Dimensions			Case Size	Package				Pallet capacity <i>See fig. 2a on page 3</i>	
			W	H	D		W	H	D	KG	Euro	Industrial
CASETYPE A: TROLLEY CASE	PUF23S	2 x 3	151	224	30	M	39	97	39	12	12	12
	PUF33S	3 x 3	224	224	30	L	49	97	39	16	8	12
	PUF43S	4 x 3	297	224	30	L	49	97	39	17	8	12
	PUF53S	5 x 3	370	224	30	XL	59	97	39	20	8	8
CASETYPE B: SOFT BAG	PUF23S-SB	2 x 3	151	224	30	-	29	85	28	8	18	27
	PUF33S-SB	3 x 3	224	224	30	-	29	85	28	10	18	27
	PUF43S-SB	4 x 3	297	224	30	-	40	85	28	12	18	20
	PUF53S-SB	5 x 3	370	224	30	-	40	85	28	14	18	20

All sizes in cm.

Max. pcs. on pallet



1: See Trolley Case on page 167



2: Optional



3: Optional, see chapter Lighting on page 84



4: Optional



Top view Straight (S)



Top view Curved (C)



W1

W1: WITHOUT SIDE PANELS



W2

W2: INCLUDING SIDE PANELS

Optional velcro (4)

Product	Velcro Loop (soft side)
Art. nr.	VEL50L
Width	50mm
Length	25m

Optional side panels

Product	Rounded side panels
Art. nr.	PUFPR

Pop-Up Fabric Premium

EN

- Backside fully equipped with velcro dots
- Stable mobile trolley M / L / XL (1)
- Wide wheel base with ball bearing wheels
- **Optional:** Rounded side panels, transporter bag included (2)
- **Optional:** LED or halogen lighting (3)
- **Optional:** Loop velcro (soft side) available (4)

DE

- Rückseite komplett ausgestattet mit Klettbandpunkten
- Stabiler mobiler Trolley M / L / XL (1)
- Breiter Radstand mit kugelgelagerten Rädern
- **Optional:** Gebogene Seitenteile inklusive Transporttasche (2)
- **Optional:** LED- oder Halogenbeleuchtung (3)
- **Optional:** Flauschband erhältlich (4)

NL

- Achterzijde volledig voorzien van klittenbandpunten
- Stabiele verrijdbare trolley M / L / XL (1)
- Brede wielbasis met kogelgelagerde wielen
- **Optioneel:** Gebogen zijpanelen inclusief transporttas (2)
- **Optioneel:** LED of halogeenverlichting (3)
- **Optioneel:** Lus klittenband (zachte kant) beschikbaar (4)

FR

- Verso complètement équipé de points velcro
- Stables valise de transport M / L / XL (1)
- Position large des roues avec roulement à billes
- **Optionnel :** Panneaux latéraux, sac de transport inclus (2)
- **Optionnel :** LED ou éclairage halogène (3)
- **Optionnel :** Velcro femelle (côte mou) disponible (4)

ES

- Parte de atrás completamente equipada de puntos de velcro
- Trolley estable M / L / XL (1)
- Amplia distancia entre ruedas con cojinete de bolas
- **Opcional:** Laterales curvados y bolsa de transporte (2)
- **Opcional:** Iluminación LED o halógena (3)
- **Opcional:** Velcro de bucle (cara suave) disponible (4)

	Art. nr.	Frame	Dimensions				Trolley	Package				Pallet capacity <i>See fig. 2a on page 3</i>	
			W1	W2	H	D		Size	W	H	D	KG	Euro
STRAIGHT	PUFP23S	2 x 3	148	184	220	36	M	39	97	39	13	12	12
	PUFP33S	3 x 3	220	256	220	36	L	49	97	39	16	8	12
	PUFP43S	4 x 3	292	328	220	36	L	49	97	39	18	8	12
	PUFP53S	5 x 3	363	399	220	36	XL	59	97	39	21	8	8
CURVED	PUFP23C	2 x 3	158	182	220	44	M	39	97	39	13	12	12
	PUFP33C	3 x 3	228	252	220	52	L	49	97	39	16	8	12
	PUFP43C	4 x 3	298	322	220	66	L	49	97	39	18	8	12
	PUFP53C	5 x 3	368	392	220	82	XL	59	97	39	21	8	8

All sizes in cm.

Max. pcs. on pallet



2: Case type A, see Hard Case on page 166



3: Case type B, see Soft Trolley on page 169



4: Optional, see page 19



5: Optional, see chapter Lighting on page 84



Top view Curved



Top view Straight

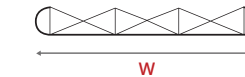

Pop-Up Magnetic

EN

- Reinforced 12 mm power magnets (1)
- Mobile hard case with firm divider to protect the prints (2)
- Padded trolley with tube bag to protect the print (3)
- **Optional:** Table top in 4 colours for hard case (4)
- **Optional:** LED or halogen lighting (5)

DE

- Verstärkte 12 mm Magnete (1)
- Mobiler Transportkoffer mit Abtrennung zum Schutz der Drucke (2)
- Gepolsterter Trolley mit extra Tasche zum Schutz der Drucke (3)
- **Optional:** Thekenplatte in 4 Farben für Transportkoffer (4)
- **Optional:** LED- oder Halogenbeleuchtung (5)

NL

- Versterkte 12 mm magneten (1)
- Verrijdbare hardcase met scheidingspaneel voor bescherming print (2)
- Gevoerde trolley met kokertas voor bescherming print (3)
- **Optioneel:** Balieblad in 4 kleuren voor hardcase (4)
- **Optioneel:** LED of halogeenverlichting (5)

FR

- Aiments renforcés de 12 mm (1)
- Valise rigide avec séparateur fixe afin de protéger les visuels (2)
- Valise souple rembourée avec tube de protection pour les visuels (3)
- **Optionnel :** Tablette supérieure de 4 couleurs pour valise rigide (4)
- **Optionnel :** LED ou éclairage halogène (5)

ES

- Imanes reforzados de 12 mm (1)
- Maleta rígida con separador firme para proteger los paneles (2)
- Trolley acolchada con estuche tubular para proteger la impresión (3)
- **Opcional:** Tablero del mostrador en 4 colores para la maleta rígida (4)
- **Opcional:** Iluminación LED o halógena (5)

Attention: See next page for options

	HARD CASE		SOFT TROLLEY				Pallet capacity <i>See fig. 2a on page 3</i>											
	Art. nr.	Art. nr.	W	H	D	KG	W	H	D	KG	HARD CASE		SOFT TROLLEY					
	Size	Size	W	H	D	KG	W	H	D	KG	Euro	Ind.	Euro	Ind.				
CURVED	PUM23C	PUM23C-ST	2 x 3	192	224	51	42	100	71	26	39	92	49	19	4	6	8	12
	PUM33C	PUM33C-ST	3 x 3	252	224	69	42	100	71	29	39	92	49	23	4	6	8	12
	PUM43C	PUM43C-ST	4 x 3	301	224	100	42	100	71	31	39	92	59	27	4	6	8	10
	PUM53C	PUM53C-ST	5 x 3	341	224	129	42	100	71	33	39	92	59	31	4	6	8	10
STRAIGHT	PUM23S	PUM23S-ST	2 x 3	197	224	32	42	100	71	26	39	92	49	19	4	6	8	12
	PUM33S	PUM33S-ST	3 x 3	270	224	32	42	100	71	29	39	92	49	23	4	6	8	12
	PUM43S	PUM43S-ST	4 x 3	343	224	32	42	100	71	31	39	92	59	27	4	6	8	10
	PUM53S	PUM53S-ST	5 x 3	417	224	32	42	100	71	33	39	92	59	31	4	6	8	10

All sizes in cm.

Max. pcs. on pallet



Extra kit for new visuals

EN

- Plastic top strips (hangers) and plastic bottom strips (kickers) (1)
- Magnetic tape (3-poles) with strong TESA self-adhesive (2)

DE

- Kunststoffstreifen oben (Hängers) und Kunststoffstreifen unten (Kickers) (1)
- Magnetband (3-Polig) mit TESA-film (2)

NL

- Kunststof bovenstrips (hangers) en kunststof onderstrips (kickers) (1)
- Magneetband (3-Polig) met sterke TESA tape (2)

FR

- Bandes plastiques haut et bas (1)
- Bande magnétique (3 pôles) avec adhésif TESA (2)

ES

- Railes de plástico arriba (hangers) y abajo (kickers) (1)
- Cinta magnética (3 polos) con autoadhesivo TESA (2)

CURVED	STRAIGHT	
Art. nr.	Art. nr.	Size
PUM23CKIT	PUM23SKIT	2 x 3
PUM33CKIT	PUM33SKIT	3 x 3
PUM43CKIT	PUM43SKIT	4 x 3
PUM53CKIT	PUM53SKIT	5 x 3

Bag for new / backside visuals

- EN Extra tube bag to protect the print
- DE Extra Tasche zum Schutz der Drucke
- NL Extra kokertas voor bescherming print
- FR Sac supplémentaire pour protéger les visuels
- ES Estuche tubular adicional para proteger el visual

Art. nr.	Ø	H
PUM-BAGV5	27,5	80
<i>Bag for new visuals max 5 panels</i>		
PUM-BAGV7	30,5	80
<i>Bag for new visuals max 7 panels</i>		
PUM-BAGV5B	27,5	87
<i>Bag for backside visuals max 5 panels</i>		

All sizes in cm.

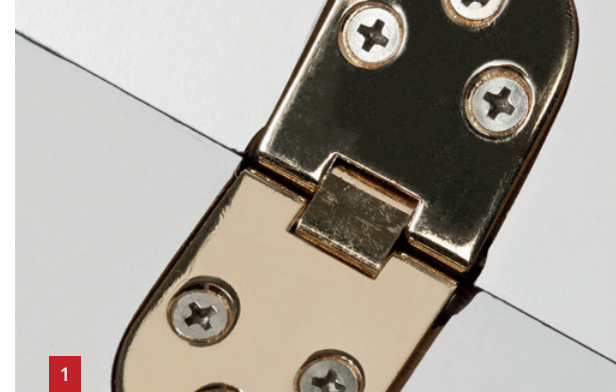

Extension kit for backside

EN

- Magnetic bar with 5-poles magnetic tape (1)
- Magnets for backside frame (2)

DE

- Magnetschiene mit 5-poligem Magnetband (1)
- Magnet für Rückseite (2)

NL

- Magneetbar met 5-polige magneettape (1)
- Magneten voor achterzijde frame (2)

FR

- Barre magnétique avec bande magnétique 5 pôles (1)
- Aimants au verso du cadre (2)

ES

- Barra magnética con cinta magnética 5 polos (1)
- Imanes para uso en la parte de atrás de la estructura (2)

Table Top

EN

- Table top in 4 colours
- Easily collapsible (1)
- Padded bag with zipper (2)

DE

- Thekenplatte in 4 Farben
- Einfach einklappbar (1)
- Tasche mit Innenfutter und Reißverschluss (2)

NL

- Balieblad in 4 kleuren
- Gemakkelijk inklapbaar (1)
- Tas met binnenvoering en ritsluiting (2)

FR

- Tablette supérieure de 4 couleurs
- Repli facilité (1)
- Sac rembourré avec fermeture éclair (2)

ES

- Tablero de mostrador en 4 colores
- Fácil de plegar (1)
- Bolsa acolchada con cremallera (2)



Art. nr.	Colour	Product
PUMTTB	●	Table Top Black
PUMTTW	●	Table Top Wood
PUMTTS	●	Table Top Silver
PUMTTWH	○	Table Top White





4: Optional, see chapter Lighting on page 84

5: Optional



Optional kit for new visuals (6)

Art. nr. PUTWRKIT Product Extra kit for new visuals

Art. nr.	Dimensions		Package				Pallet capacity	
	Ø	H	W	H	D	KG	Euro	Industrial
PUTWR	64	225	30	91	43	16,5	12	16
All sizes in cm.								
							See fig. 2a on page 3	
							Max. pcs. on pallet	

Pop-Up Tower

EN

- Aluminium frame with patented hinges and magnetic locking (1)
- Padded trolley with tube bag to protect the print (2)
- Equipped with fixation for light (3)
- Optional:** LED or halogen lighting (4)
- Optional:** Extra kit for new visuals, including plastic top strips (hangers) and magnetic tape (3-poles) with strong TESA self-adhesive (5)

DE

- Aluminiumrahmen mit patentierten Scharnieren und Magnetverriegelung (1)
- Gepolsteter Trolley mit extra Tasche zum Schutz der Drucke (2)
- Standardmäßig geliefert mit Befestigungssystem für die Beleuchtung (3)
- Optional:** LED- oder Halogenbeleuchtung (4)
- Optional:** Zusatzkit für neue Visuals, mit Kunststoffstreifen oben (Hänger) und Magnetband (3-Polig) mit starkem TESA-Film (5)

NL

- Aluminium frame met gepatenteerde scharnieren en magneetsluiting (1)
- Gevoerde trolley met kokertas voor bescherming print (2)
- Standaard voorzien van bevestigingssysteem voor verlichting (3)
- Optioneel:** LED of halogeenverlichting (4)
- Optioneel:** Extra kit voor nieuwe visuals, met kunststof bovenstrips (hangers) en magneetband (3-polig) met sterke TESA tape (5)

FR

- Structure aluminium avec charnière et fixation magnétique brevetées (1)
- Valise souple rembourée avec tube de protection pour les visuels (2)
- Fourni avec système de fixation pour lampe (3)
- Optionnel :** LED ou éclairage halogène (4)
- Optionnel :** Kit supplémentaire pour nouveaux visuels, avec bandes supérieures plastique (hangers) et bande magnétique (3 pôles) avec adhésif TESA (5)

ES

- Estructura de aluminio con bisagras y cierre magnética patentadas (1)
- Trolley acolchada con estuche tubular para proteger la impresión (2)
- Equipado con punto de fijación para iluminación (3)
- Opcional:** Iluminación LED o halógena (4)
- Opcional:** Kit adicional para visuales nuevos, con raíles superiores de plástico (hangers) y cinta magnética (3 polos) con autoadhesivo TESA (5)

Zipper-Walls

Curved	30
Straight	32
Arch	34
Wave	36
Moon	38
Banner	40
Sizes	42

5 YEAR
WARRANTY
★★★★★



1



2



3



4: Optional, see chapter Lighting on page 84



5: Optional, see Wall Light Options on page 97

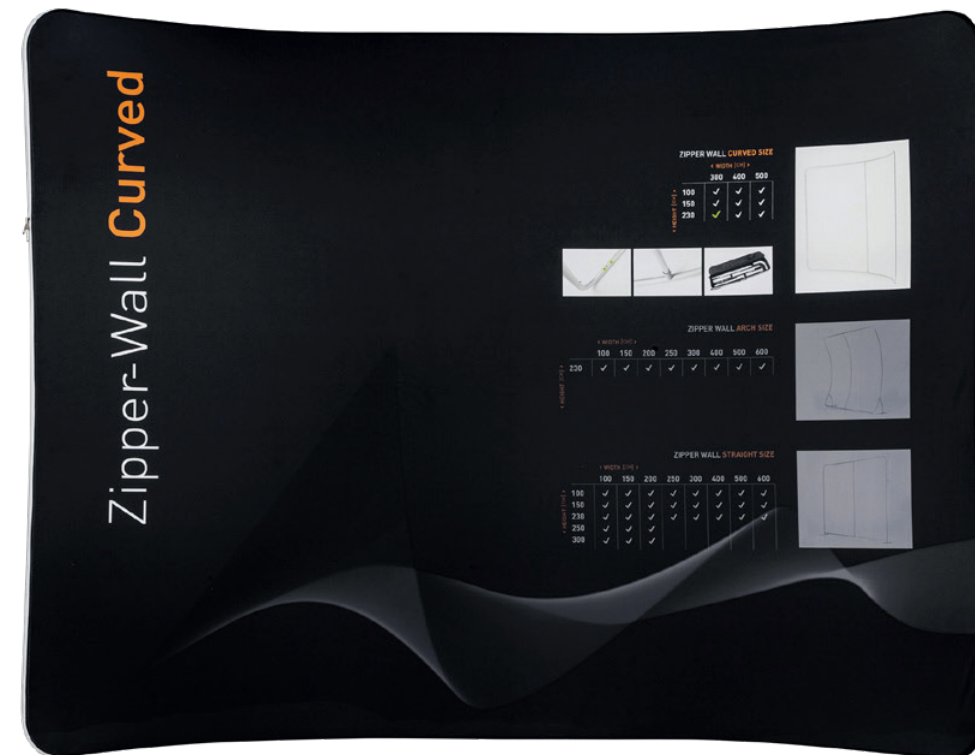

! Important: Available in 9 sizes

Width: Between 300 and 500 cm
Height: Between 100 and 230 cm

Example: ZWC300-230:
 Width 300 cm and height 230 cm

Art. nr.	Dimensions			Trolley Size
	W	H	D	
ZWC300-100	300	100	60	M
ZWC400-100	400	100	80	L
ZWC500-100	500	100	100	L
ZWC300-150	300	150	60	L
ZWC400-150	400	150	80	L
ZWC500-150	500	150	100	L
ZWC300-230	300	230	60	L
ZWC400-230	400	230	80	XL
ZWC500-230	500	230	100	XL

All sizes in cm.



Zipper-Wall Curved

EN

- Anodised aluminium (Ø 34 mm) (1)
- Support pole (Ø 24 mm) with security clip (2)
- Reinforced transport trolley for durable professional use with ball bearing wheels (3)
- **Optional:** LED or halogen lighting (4)
- **Optional:** Clamp for lighting (5)

DE

- Eloxiertes Aluminium (Ø 34 mm) (1)
- Stabilisierungsstange (Ø 24 mm) mit Sicherheitsclip (2)
- Verstärkter Transporttrolley für Langzeitgebrauch mit kugelgelagerten Rädern (3)
- **Optional:** LED- oder Halogenbeleuchtung (4)
- **Optional:** Klemme für Beleuchtung (5)

NL

- Geanodiseerd aluminium (Ø 34 mm) (1)
- Ondersteuningspaal (Ø 24 mm) met borgveer (2)
- Versterkte transporttrolley voor langdurig professioneel gebruik met kogelgelagerde wielen (3)
- **Optioneel:** LED of halogeenverlichting (4)
- **Optioneel:** Klem voor verlichting (5)

FR

- Aluminium anodisé (Ø 34 mm) (1)
- Support de mât (Ø 24 mm) avec clip de sécurité (2)
- Valise de transport renforcée pour une utilisation professionnelle durable avec roulettes à roulement à billes (3)
- **Optionnel :** LED ou éclairage halogène (4)
- **Optionnel :** Fixation pour éclairage (5)

ES

- Aluminio anodizado (Ø 34 mm) (1)
- Poste de soporte (Ø 24 mm) con clip de seguridad (2)
- Trolley de transporte reforzado para un uso duradero y profesional con ruedas con cojinetes (3)
- **Opcional:** Iluminación LED o halógena (4)
- **Opcional:** Abrazadera para iluminación (5)



4: Optional, see chapter Lighting on page 84

5: Optional, see Wall Light Options on page 97

Zipper-Wall **Straight**

EN

- Anodised aluminium (Ø 34 mm) (1)
- Support pole (Ø 24 mm) with security clip (2)
- Reinforced transport trolley for durable professional use with ball bearing wheels (3)
- **Optional:** LED or halogen lighting (4)
- **Optional:** Clamp for lighting (5)

DE

- Eloxiertes Aluminium (Ø 34 mm) (1)
- Stabilisierungsstange (Ø 24 mm) mit Sicherheitsclip (2)
- Verstärkter Transporttrolley für Langzeitgebrauch mit kugelgelagerten Rädern (3)
- **Optional:** LED- oder Halogenbeleuchtung (4)
- **Optional:** Klemme für Beleuchtung (5)

NL

- Geanodiseerd aluminium (Ø 34 mm) (1)
- Ondersteuningspaal (Ø 24 mm) met borgveer (2)
- Verstevigde transporttrolley voor langdurig professioneel gebruik met kogelgelagerde wielen (3)
- **Optioneel:** LED of halogeenverlichting (4)
- **Optioneel:** Klem voor verlichting (5)

! Important: Available in 30 sizes

Width: Between 100 and 600 cm
Height: Between 100 and 300 cm

Example: ZWS300-230:
 Width 300 cm and height 230 cm



FR

- Aluminium anodisé (Ø 34 mm) (1)
- Support de mât (Ø 24 mm) avec clip de sécurité (2)
- Valise de transport renforcée pour une utilisation professionnelle durable avec roulette à roulement à billes (3)
- **Optionnel :** LED ou éclairage halogène (4)
- **Optionnel :** Fixation pour éclairage (5)

ES

- Aluminio anodizado (Ø 34 mm) (1)
- Poste de soporte (Ø 24 mm) con clip de seguridad (2)
- Trolley de transporte reforzado para un uso durable y profesional con cojinete de bolas (3)
- **Opcional:** Iluminación LED o halógena (4)
- **Opcional:** Abrazadera para iluminación (5)

Art. nr.	Dimensions			Trolley Size	Art. nr.	Dimensions			Trolley Size
	W	H	D			W	H	D	
ZWS100-100	100	100	45	M	ZWS100-230	100	230	45	M
ZWS150-100	150	100	45	M	ZWS150-230	150	230	45	M
ZWS200-100	200	100	45	M	ZWS200-230	200	230	45	M
ZWS250-100	250	100	45	M	ZWS250-230	250	230	45	L
ZWS300-100	300	100	45	L	ZWS300-230	300	230	45	L
ZWS400-100	400	100	45	L	ZWS400-230	400	230	45	XL
ZWS500-100	500	100	45	XL	ZWS500-230	500	230	45	XL
ZWS600-100	600	100	45	XL	ZWS600-230	600	230	45	XL
ZWS100-150	100	150	45	M	ZWS100-250	100	250	45	M
ZWS150-150	150	150	45	M	ZWS150-250	150	250	45	M
ZWS200-150	200	150	45	M	ZWS200-250	200	250	45	M
ZWS250-150	250	150	45	M					
ZWS300-150	300	150	45	L	ZWS100-300	100	300	45	L
ZWS400-150	400	150	45	L	ZWS150-300	150	300	45	L
ZWS500-150	500	150	45	XL	ZWS200-300	200	300	45	L
ZWS600-150	600	150	45	XL					

All sizes in cm.





1



2



3



4: Optional, see chapter Lighting on page 84



5: Optional, see Wall Light Options on page 97



! Important: Available in 8 sizes

Width: Between 100 and 600 cm
Height: 230 cm

Example: ZWA300-230:
Width 300 cm and height 230 cm

Art. nr.

ZWA100-230
ZWA150-230
ZWA200-230
ZWA250-230
ZWA300-230
ZWA400-230
ZWA500-230
ZWA600-230

All sizes in cm.

Dimensions

W	H	D
100	230	50
150	230	50
200	230	50
250	230	50
300	230	50
400	230	50
500	230	50
600	230	50

Trolley

Size
XL
XL
XL
XL
XL
XL
XL
XL

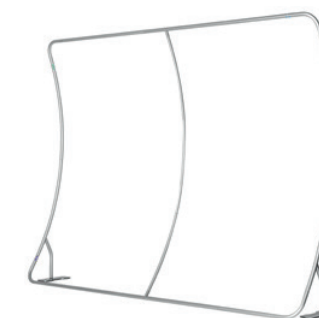

Zipper-Wall Arch

EN

- Anodised aluminium (Ø 34 mm) (1)
- Solid powder coated steel base
- Support pole (Ø 24 mm) with security clip (2)
- Reinforced transport trolley for durable professional use with ball bearing wheels (3)
- **Optional:** LED or halogen lighting (4)
- **Optional:** Clamp for lighting (5)

DE

- Eloxiertes Aluminium (Ø 34 mm) (1)
- Solider pulverbeschichteter Stahlfuß
- Stabilisierungsstange (Ø 24 mm) mit Sicherheitsclip (2)
- Verstärkter Transporttrolley für Langzeitgebrauch mit kugelgelagerten Rädern (3)
- **Optional:** LED- oder Halogenbeleuchtung (4)
- **Optional:** Klemme für Beleuchtung (5)

NL

- Geanodiseerd aluminium (Ø 34 mm) (1)
- Stevige gepoedercoate stalen voet
- Ondersteuningspaal (Ø 24 mm) met borgveer (2)
- Verstevigde transporttrolley voor langdurig professioneel gebruik met kogelgelagerde wielen (3)
- **Optioneel:** LED of halogeenverlichting (4)
- **Optioneel:** Klem voor verlichting (5)

FR

- Aluminium anodisé (Ø 34 mm) (1)
- Base résistante avec revêtement poudre
- Support de mât (Ø 24 mm) avec clip de sécurité (2)
- Valise de transport renforcée pour une utilisation professionnelle durable avec roulette à roulement à billes (3)
- **Optionnel :** LED ou éclairage halogène (4)
- **Optionnel :** Fixation pour éclairage (5)

ES

- Aluminio anodizado (Ø 34 mm) (1)
- Base sólida lacado en mate
- Poste de soporte (Ø 24 mm) con clip de seguridad (2)
- Trolley de transporte reforzado para un uso durable y profesional con cojinete de bolas (3)
- **Opcional:** Iluminación LED o halógena (4)
- **Opcional:** Abrazadera para iluminación (5)



1



2



3



4: Optional, see chapter Lighting on page 84



5: Optional, see Wall Light Options on page 97



Zipper-Wall Wave

EN

- Anodised aluminium (Ø 34 mm) (1)
- Support pole (Ø 24 mm) with security clip (2)
- Reinforced transport trolley for durable professional use with ball bearing wheels (3)
- **Optional:** LED or halogen lighting (4)
- **Optional:** Clamp for lighting (5)

DE

- Eloxiertes Aluminium (Ø 34 mm) (1)
- Stabilisierungsstange (Ø 24 mm) mit Sicherheitsclip (2)
- Verstärkter Transporttrolley für Langzeitgebrauch mit kugelgelagerten Rädern (3)
- **Optional:** LED- oder Halogenbeleuchtung (4)
- **Optional:** Klemme für Beleuchtung (5)

NL

- Geanodiseerd aluminium (Ø 34 mm) (1)
- Ondersteuningspaal (Ø 24 mm) met borgveer (2)
- Versterigde transporttrolley voor langdurig professioneel gebruik met kogelgelagerde wielen (3)
- **Optioneel:** LED of halogeenverlichting (4)
- **Optioneel:** Klem voor verlichting (5)

FR

- Aluminium anodisé (Ø 34 mm) (1)
- Support de mât (Ø 24 mm) avec clip de sécurité (2)
- Valise de transport renforcée pour une utilisation professionnelle durable avec roulette à roulement à billes (3)
- **Optionnel :** LED ou éclairage halogène (4)
- **Optionnel :** Fixation pour éclairage (5)

ES

- Aluminio anodizado (Ø 34 mm) (1)
- Poste de soporte (Ø 24 mm) con clip de seguridad (2)
- Trolley de transporte reforzado para un uso durable y profesional con cojinete de bolas (3)
- **Opcional:** Iluminación LED o halógena (4)
- **Opcional:** Abrazadera para iluminación (5)



Art. nr.

ZW-Wave

All sizes in cm.

Dimensions

W	H	D
300	230	45

Trolley

Size

L



1



2



3



4: Optional, see chapter Lighting on page 84



5: Optional, see Wall Light Options on page 97

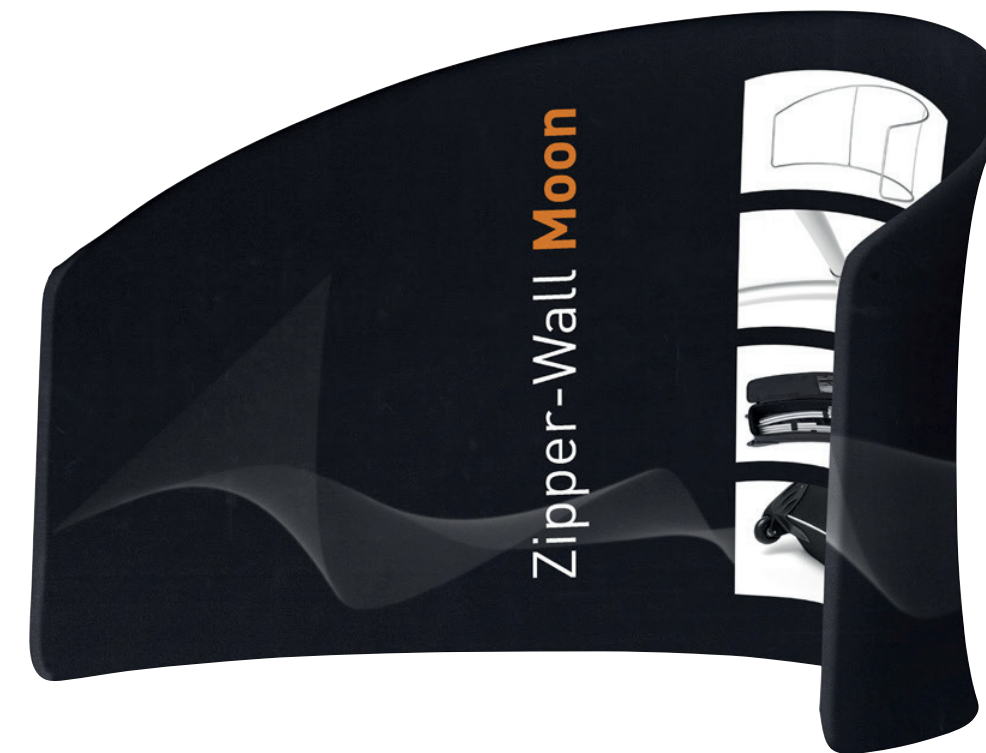

Zipper-Wall Moon

EN

- Anodised aluminium (Ø 34 mm) (1)
- Extremely stable due to smooth bended curve
- Support pole (Ø 24 mm) with security clip (2)
- Reinforced transport trolley for durable professional use with ball bearing wheels (3)
- **Optional:** LED or halogen lighting (4)
- **Optional:** Clamp for lighting (5)

DE

- Eloxiertes Aluminium (Ø 34 mm) (1)
- Extrem stabil mit hoher Standfestigkeit aufgrund gekrümmter Form
- Stabilisierungsstange (Ø 24 mm) mit Sicherheitsclip (2)
- Verstärkter Transporttrolley für Langzeitgebrauch mit kugelgelagerten Rädern (3)
- **Optional:** LED- oder Halogenbeleuchtung (4)
- **Optional:** Klemme für Beleuchtung (5)

Top view



NL

- Geanodiseerd aluminium (Ø 34 mm) (1)
- Erg stabiel door vloeiend gebogen curve
- Ondersteuningspaal (Ø 24 mm) met borgveer (2)
- Verstevigde transporttrolley voor langdurig professioneel gebruik met kogelgelagerde wielen (3)
- **Optioneel:** LED of halogeenverlichting (4)
- **Optioneel:** Klem voor verlichting (5)

FR

- Aluminium anodisé (Ø 34 mm) (1)
- Stabilité renforcée grâce à sa forme courbée
- Support de mât (Ø 24 mm) avec clip de sécurité (2)
- Valise de transport renforcée pour une utilisation professionnelle durable avec roulette à roulement à billes (3)
- **Optionnel :** LED ou éclairage halogène (4)
- **Optionnel :** Fixation pour éclairage (5)

ES

- Aluminio anodizado (Ø 34 mm) (1)
- Extremadamente estable por su forma curvada
- Poste de soporte (Ø 24 mm) con clip de seguridad (2)
- Trolley de transporte reforzado para un uso durable y profesional con cojinete de bolas (3)
- **Opcional:** Iluminación LED o halógena (4)
- **Opcional:** Abrazadera para iluminación (5)

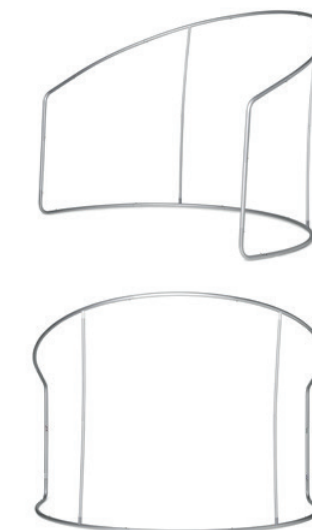

Art. nr.

ZW-Moon

All sizes in cm.

Dimensions

W	H	D
280	200	170

Trolley

Size

XL

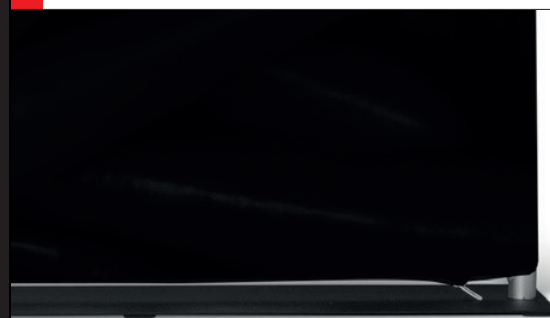

4: Optional, see chapter Lighting on page 84

5: Optional, see Wall Light Options on page 97



Zipper-Wall **Banner**

EN

- Anodised aluminium (Ø 34 mm) (1)
- Black steel plate, available in 3 width measurements (2)
- Padded bag with braces and zipper over full length (3)
- **Optional:** LED or halogen lighting (4)
- **Optional:** Clamp for lighting (5)

DE

- Eloxiertes Aluminium (Ø 34 mm) (1)
- Schwarze Stahlplatte erhältlich in 3 Größen (2)
- Verstärkte Tasche mit Innenfutter und Reißverschluss über die ganze Taschenlänge (3)
- **Optional:** LED- oder Halogenbeleuchtung (4)
- **Optional:** Klemme für Beleuchtung (5)

NL

- Geanodiseerd aluminium (Ø 34 mm) (1)
- Zwarte staalplaat in 3 breedtematen (2)
- Gevoerde tas met binnenvoering en ritssluiting over volledige lengte (3)
- **Optioneel:** LED of halogeenverlichting (4)
- **Optioneel:** Klem voor verlichting (5)

FR

- Aluminium anodisé (Ø 34 mm) (1)
- Plaque en acier noir disponible en 3 largeurs (2)
- Sac renforcé avec doublure et fermeture éclair sur toute la longueur (3)
- **Optionnel :** LED ou éclairage halogène (4)
- **Optionnel :** Fixation pour éclairage (5)

ES

- Aluminio anodizado (Ø 34 mm) (1)
- Placa de acero negro, disponible en 3 anchos distintos (2)
- Bolsa acolchada y reforzada con cremallera a todo lo largo (3)
- **Opcional:** Iluminación LED o halógena (4)
- **Opcional:** Abrazadera para iluminación (5)

! Important: Available in 7 sizes

Width: Between 60 and 100 cm
Height: Between 150 and 300 cm

Example: ZWB100-200:
 Width 100 cm and height 200 cm

Art. nr.	Dimensions			Steel plate
	W	H	D	
ZWB060-150	60	150	25	5
ZWB060-200	60	200	25	5
ZWB080-150	80	150	25	7
ZWB080-200	80	200	25	7
ZWB100-200	100	200	25	9
ZWB100-250	100	250	25	9
ZWB100-300	100	300	25	9

All sizes in cm.

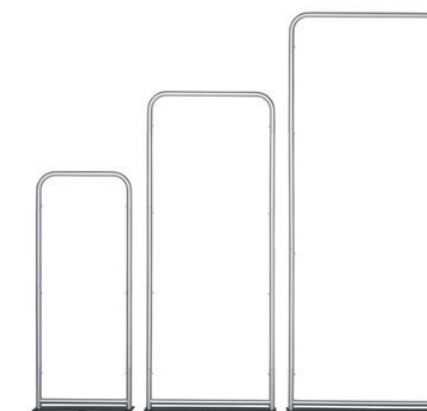

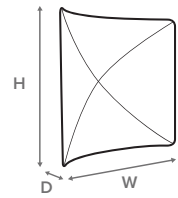

Zipper-Wall **Curved**

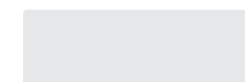

ZWC300-100

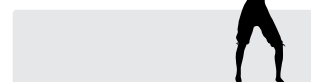

ZWC400-100

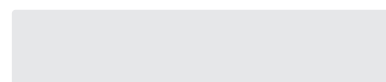

ZWC500-100



ZWC300-150



ZWC400-150



ZWC500-150



ZWC300-230



ZWC400-230



ZWC500-230

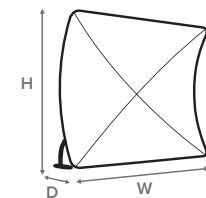

Zipper-Wall **Arch**

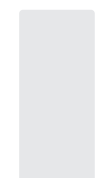

ZWA100-230

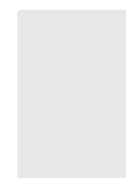

ZWA150-230

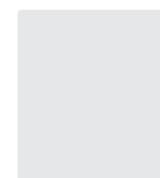

ZWA200-230

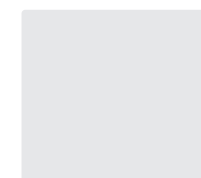

ZWA250-230

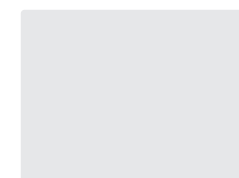

ZWA300-230

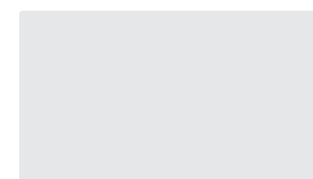

ZWA400-230

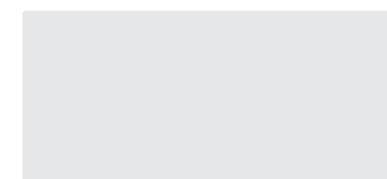

ZWA500-230

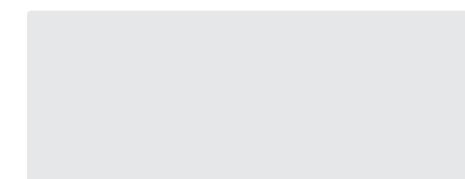

ZWA600-230

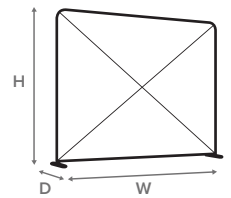

Zipper-Wall **Straight**

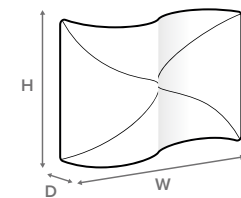
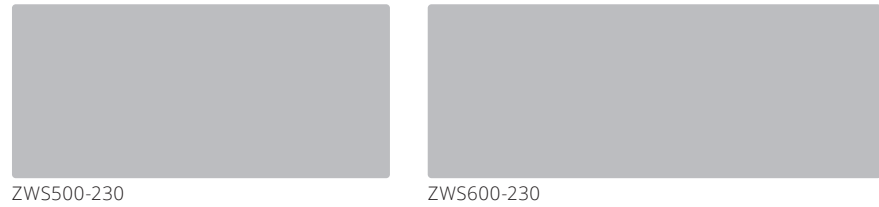
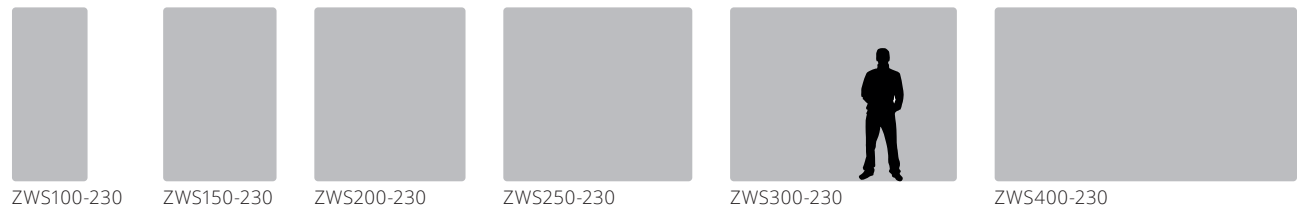
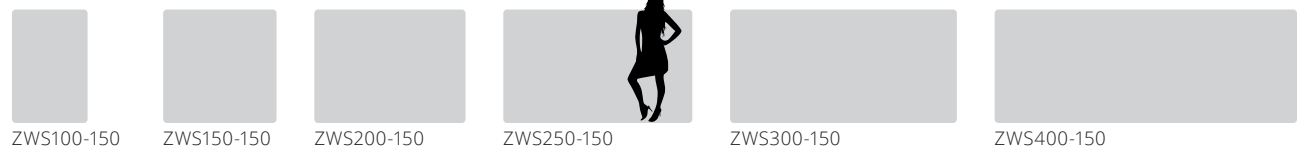
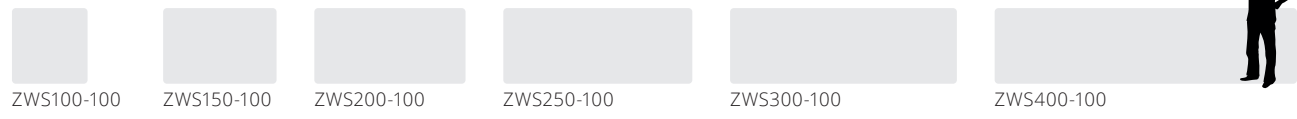

Zipper-Wall **Wave**

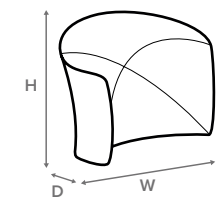
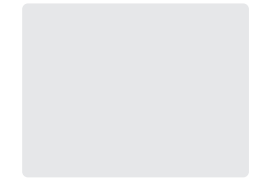

Zipper-Wall **Moon**

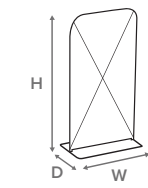

Zipper-Wall **Banner**

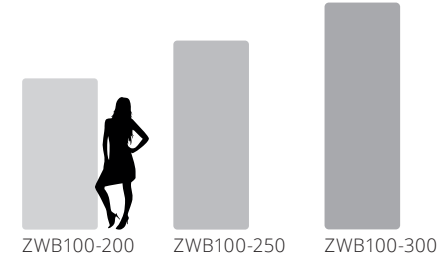
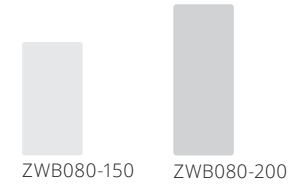
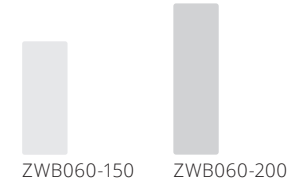

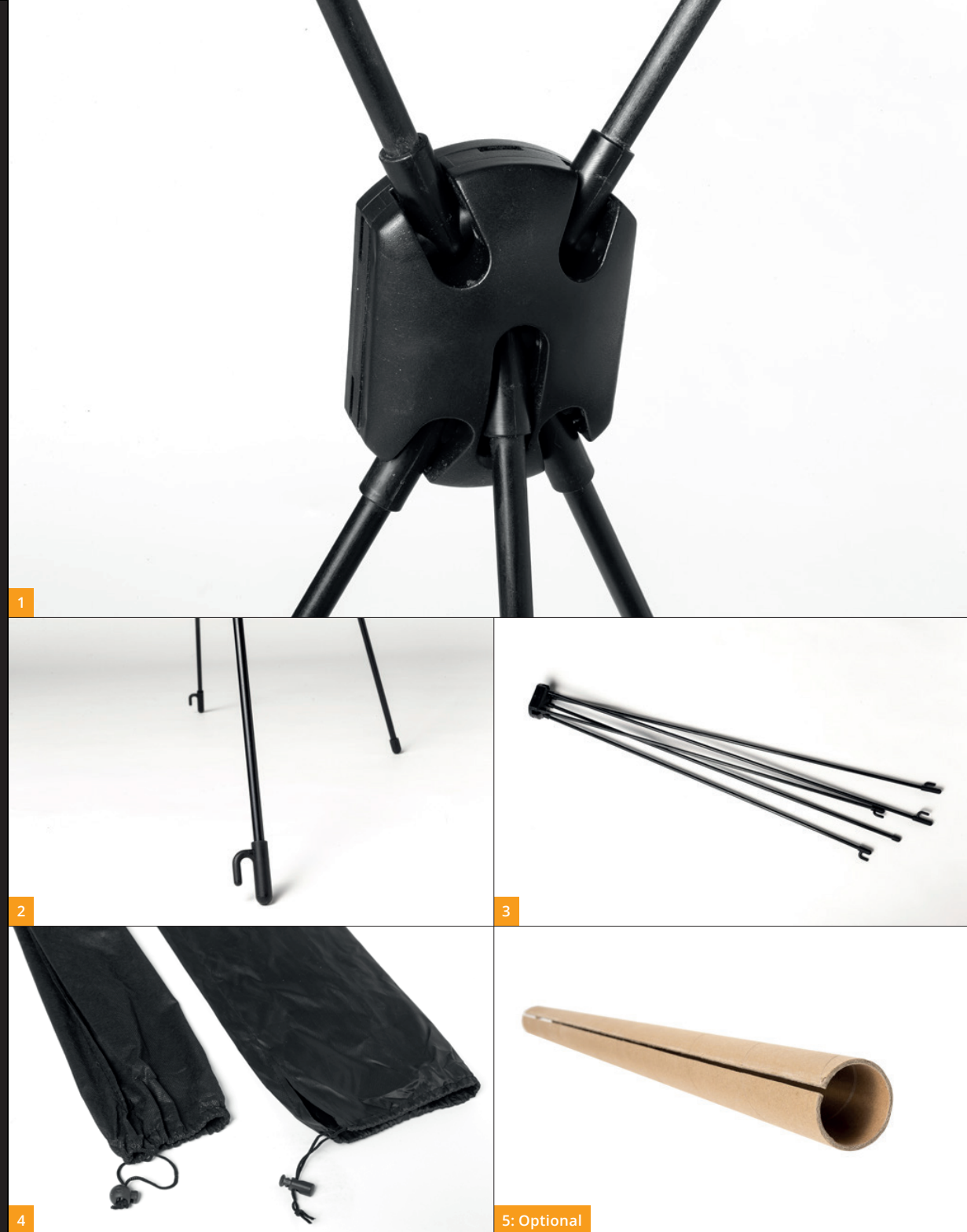

X-Banner **Budget**

- EN**
- Center connector (1)
 - Low position bottom hook (2)
 - Compact storage (3)
 - Protection pouch included (left), transporter bag is optional (right) (4)
 - **Optional:** Cardboard tube for protection prints (5)

- DE**
- Zentraler Verbindungspunkt (1)
 - Niedrig positionierter Haken unten (2)
 - Kompakt zu lagern (3)
 - Schutztasche inklusive (links), Transporttasche ist optional (rechts) (4)
 - **Optional:** Papprolle zum Schutz der Drucke (5)

- NL**
- Centraal verbindingpunt (1)
 - Laag gepositioneerde onderhaak (2)
 - Compact op te bergen (3)
 - Inclusief beschermende hoes (links), transporttas is optioneel (rechts) (4)
 - **Optioneel:** Kartonnen koker voor bescherming prints (5)

- FR**
- Connecteur central (1)
 - Crochets en position basse (2)
 - Rangement compact (3)
 - Sac de protection inclus (à gauche), sac de transport en option (à droite) (4)
 - **Optionnel :** Tube de rangement en carton afin de protéger les visuels (5)

- ES**
- Conector central (1)
 - Gancho inferior (2)
 - Almacenaje compacto (3)
 - Funda de protección incluida (izquierda), la bolsa de transporte es opcional (derecha) (4)
 - **Opcional:** Tubo de cartón para la protección de los visuales (5)

Optional cardboard tube (5)

Art. nr.	Product
BT060	Banner Tube 60cm
BT080	Banner Tube 80cm

Art. nr.	Graphic		Package <i>See fig. 1a on page 3</i>					Pallet capacity <i>See fig. 2a on page 3</i>	
	W	H	W	H	D	KG	⊗ in ⊙	Euro	Industrial
XBB60-160	60	160	30	96	40	16	40	480	720
XBB80-180	80	180	30	106	40	16	40	480	720
XBB80-200	80	200	30	116	40	16	40	480	720

All sizes in cm.

Max. pcs. on pallet

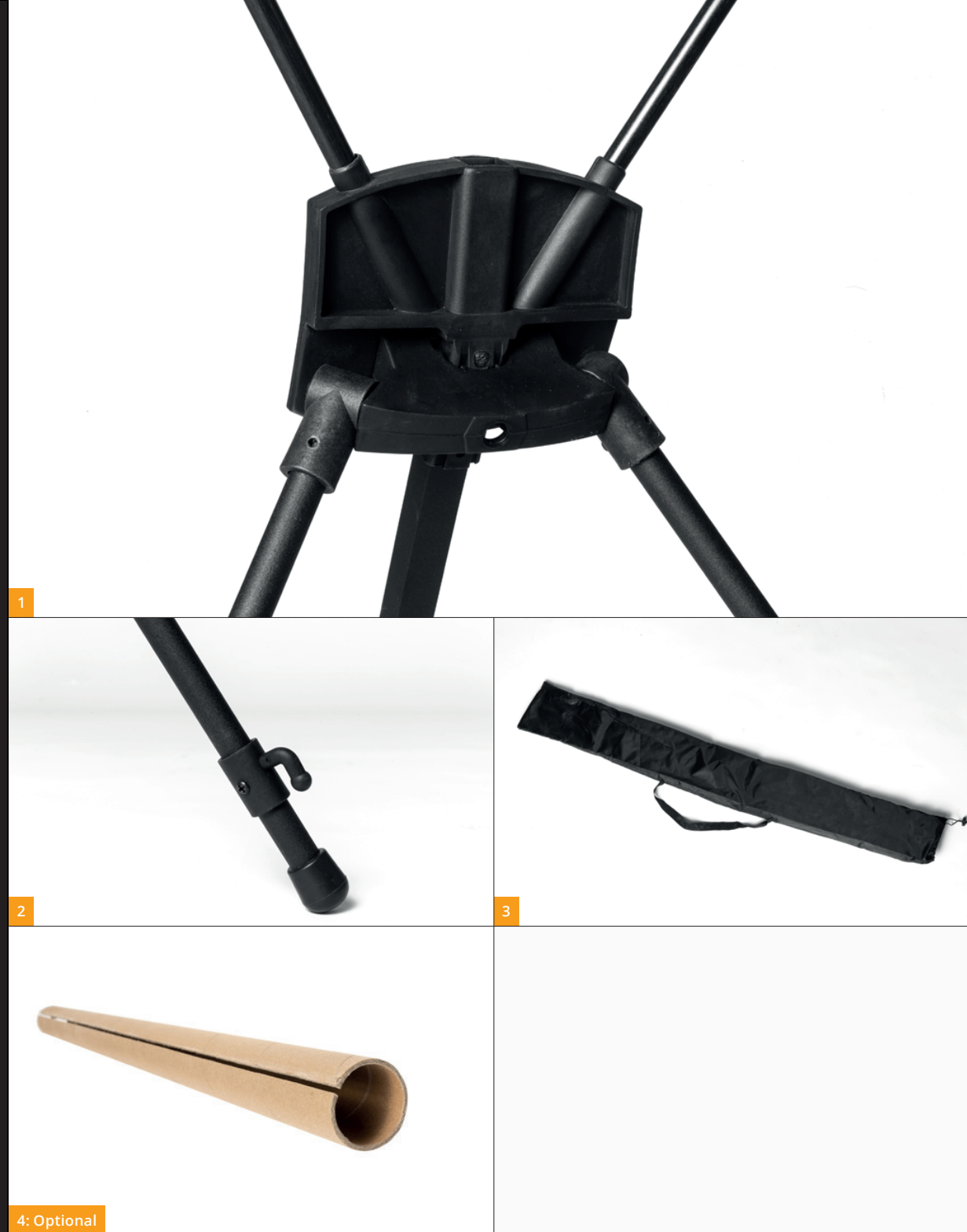

4: Optional



X-Banner Premium

EN

- Aluminium tripod with fiber tops
- Center connector (1)
- Low position bottom hook (2)
- Transporter bag (3)
- **Optional:** Cardboard tube for protection prints (4)

DE

- Aluminium-Stativ mit Fiberglasstangen oben
- Zentraler Verbindungspunkt (1)
- Niedrig positionierter Haken unten (2)
- Transporttasche (3)
- **Optioneel:** Papprolle zum Schutz der Drucke (4)

NL

- Aluminium driepoot met fiberglas toppalen
- Centraal verbindingpunt (1)
- Laag gepositioneerde onderhaak (2)
- Transporttas (3)
- **Optioneel:** Kartonnen koker voor bescherming prints (4)

FR

- Trépied aluminium avec mâts supérieurs en fibre de verre
- Connecteur central (1)
- Crochets en position basse (2)
- Sac pour transport (3)
- **Optionnel :** Tube de rangement en carton afin de protéger les visuels (4)

ES

- Trípode de aluminio con tapas superiores de fibra de vidrio
- Conector central (1)
- Gancho inferior (2)
- Bolsa de transporte (3)
- **Opcional:** Tubo de cartón para la protección de los visuales (4)

Optional cardboard tube (4)

Art. nr.	Product
BT060	Banner Tube 60cm
BT080	Banner Tube 80cm
BT100	Banner Tube 100cm
BT120	Banner Tube 120cm

Art. nr.	Graphic		Package <i>See fig. 1a on page 3</i>					Pallet capacity <i>See fig. 2a on page 3</i>	
	W	H	W	H	D	KG	⊗ in ⊙	Euro	Industrial
XBP060	60	160	20	101	38	20	15	330	450
XBP080	80	180	20	121	38	22	15	300	225
XBP100	100	200	22	140	38	17	10	100	120
XBP120	120	200	22	140	38	18	10	100	120

All sizes in cm.

Max. pcs. on pallet

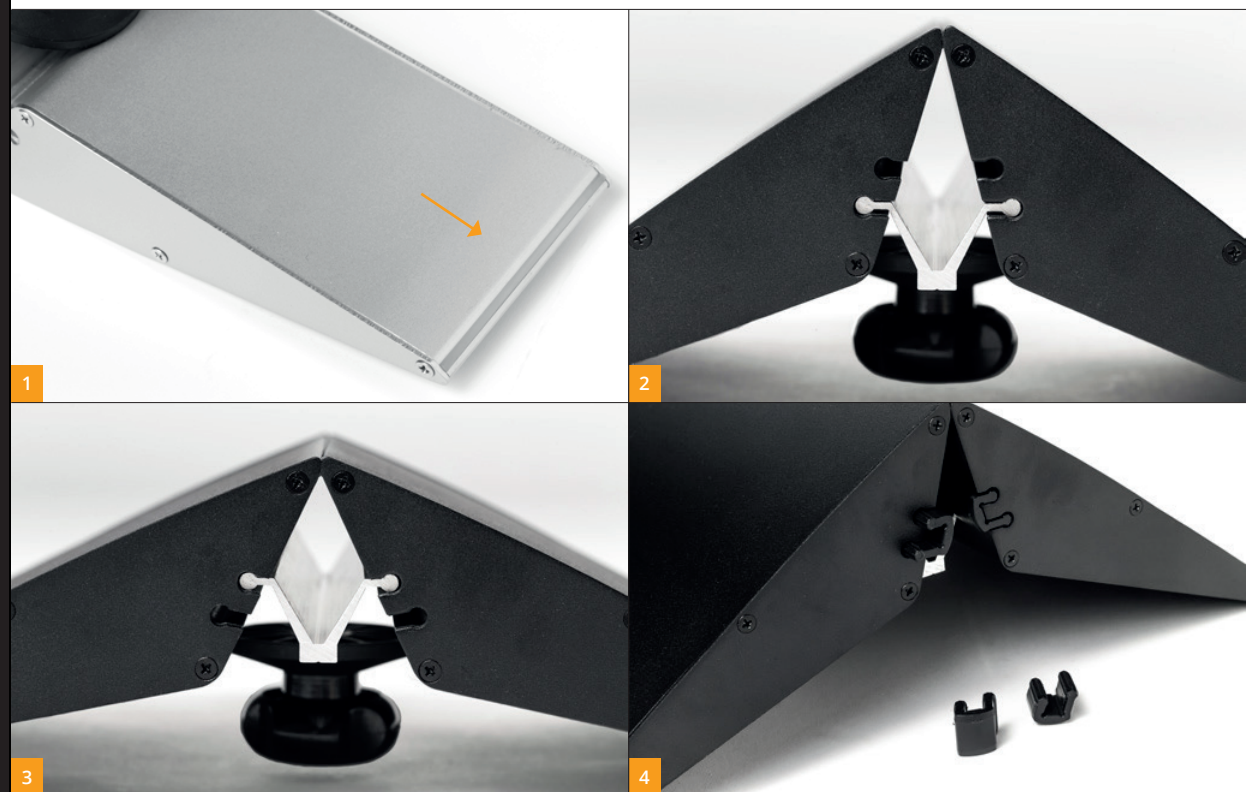

Panel Base **Aluminium**

EN

- Stable aluminium base
- Anti-slip silicon (1)
- Stand 1: panel thickness 3 - 18 mm (2)
- Stand 2: panel thickness 18 - 26 mm (3)
- Stoppers (4)

DE

- Stabiler Aluminiumfuß
- Antirutsch-Silikon (1)
- Position 1: Wandstärke 3 - 18 mm (2)
- Position 2: Wandstärke 18 - 26 mm (3)
- Sicherheitsklammern (4)

NL

- Stabiele aluminium voet
- Antislip silicone (1)
- Stand 1: paneeldikte 3 - 18 mm (2)
- Stand 2: paneeldikte 18 - 26 mm (3)
- Stopdopjes (4)

FR

- Base en aluminium stable
- Silicone antidérapant (1)
- Stand 1 : épaisseur du panneau 3 - 18 mm (2)
- Stand 2 : épaisseur du panneau 18 - 26 mm (3)
- Calles (4)

ES

- Base de aluminio estable
- Silicona antideslizante (1)
- Posición 1: grosor del panel 3 - 18 mm (2)
- Posición 2: grosor del panel 18 - 26 mm (3)
- Tapones (4)

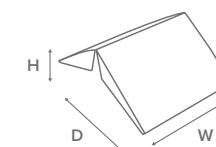

Art. nr.

Colour

PBAS10
PBAS30
PBAS50

●
●
●

PBAB10
PBAB30
PBAB50

●
●
●

All sizes in cm.

Dimensions

W	H	D
10	14	38
30	14	38
50	14	38

Package *See fig. 1a on page 3*

W	H	D	KG	⊗ in ⊙
32	25	41	6	4
32	33	41	7	2
32	53	41	10	2

Pallet capacity *See fig. 2a on page 3*

Euro	Industrial
192	188
72	108
48	72

Max. pcs. on pallet

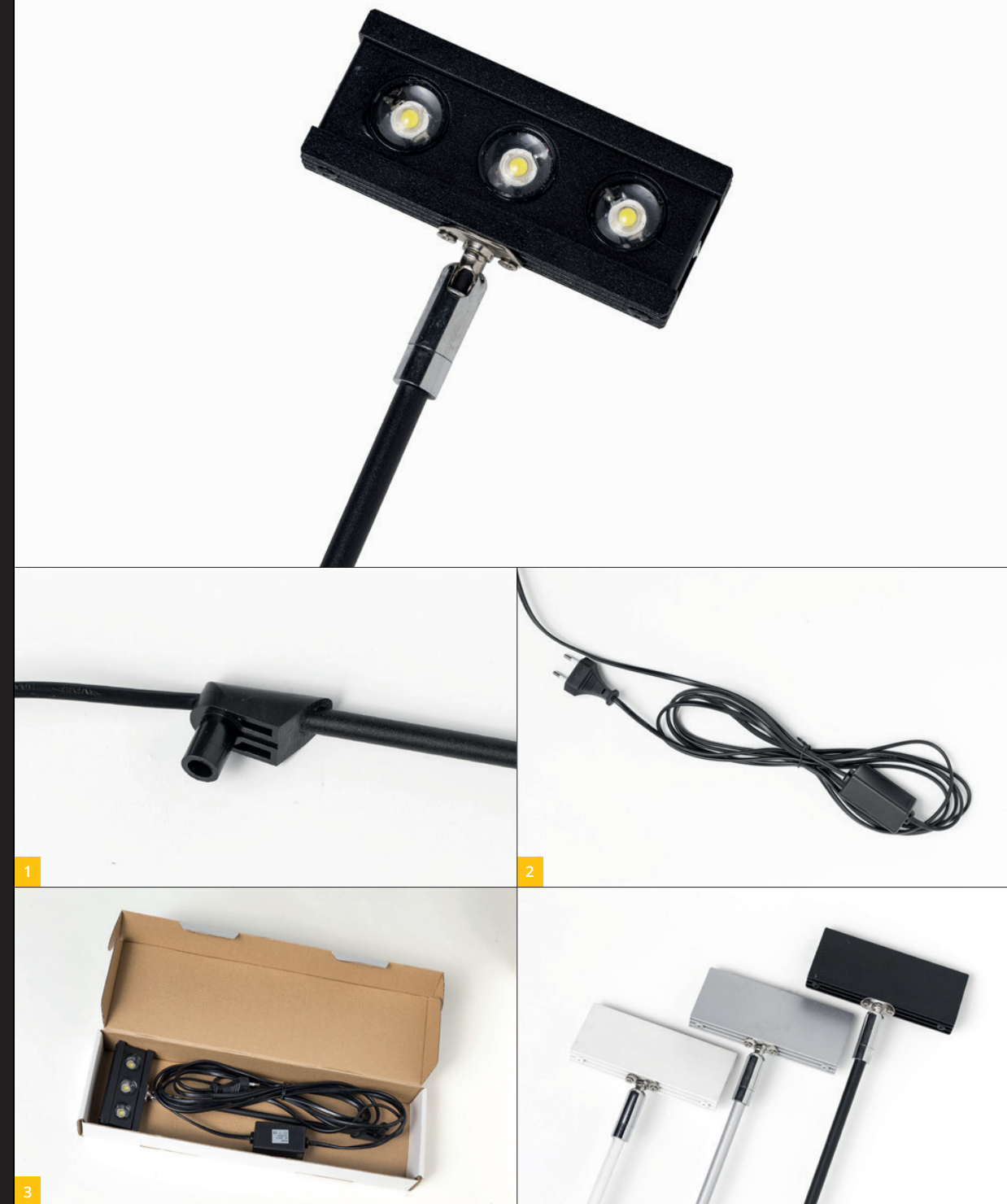

Lighting **Banner LED**

EN

- Three bright power LEDs
- Powder coating available in black, silver or white
- Connection part suitable on all our Roll-Banners (1)
- 3 m power cable (2)
- Single piece cardboard packaging (3)

DE

- Drei helle power LEDs
- Pulverlackbeschichtung verfügbar in schwarz, silber oder weiß
- Verbindungsteil passend auf jeden unserer Roll-Banners (1)
- 3 m Stromkabel (2)
- Einzelstück Kartonverpackung (3)

NL

- Drie heldere power LEDs
- Poedercoating beschikbaar in zwart, zilver of wit
- Verbindingsdeel passend op al onze Roll-Banners (1)
- 3 m stroomkabel (2)
- Kartonnen stuksverpakking (3)

FR

- Trois LEDs puissantes
- Recouvert de poudre disponible en noir, argent ou blanc
- Pièce de connexion adaptable sur toutes nos Roll-Banners (1)
- Cable d'alimentation de 3 m (2)
- Emballage par carton individuel (3)

ES

- Tres LED brillantes
- Lacado disponible en negro, plata o blanco
- Acoplamiento para todos nuestros Roll-Banners (1)
- Cable de alimentación de 3 m (2)
- Envase en cartón individual (3)

Colour temperature 4000 kelvin
Light brightness 600 lumen

Power consumption 8 watt
Equivalent to halogen 80 watt

Length power cable 300 cm
Consistent burning hours 7000 hours

Art. nr. **Colour**

BLED3B ●
BLED3S ●
BLED3W ○

All sizes in cm.

Package See fig. 1b on page 3

W	H	D	KG	⊗ in ⊙	⊗ in ⊚
28	87	52	20	10	40
28	87	52	20	10	40
28	87	52	20	10	40



Banner Light Halogen 35 Watt

EN

- 35 watt halogen light
- Suitable for any banner type because of clip
- Bag with zipper (1)

DE

- Halogenlampe 35 Watt
- Geeignet für alle Banner-Systeme mittels Universalklemme
- Tasche mit Reißverschluss (1)

NL

- 35 watt halogeenlamp
- Geschikt voor iedere banner door klem
- Tas met ritssluiting (1)

FR

- Lampe halogène 35 watt
- Adaptable à toutes les bannières grâce au clip
- Sac avec fermeture éclair (1)

ES

- Foco halógena 35 vatios
- Adecuado para cualquier tipo de banner con la pinza universal
- Bolsa con cremallera (1)



Banner Light Halogen 50 Watt

EN

- 50 watt halogen light
- Metal casing available in silver or black (1)
- Single piece carton packing (2)

DE

- Halogenlampe 50 Watt
- Metallgehäuse verfügbar in silber oder schwarz (1)
- In Einzelkartonagen verpackt (2)

NL

- 50 watt halogeenlamp
- Metalen behuizing verkrijgbaar in zilver of zwart (1)
- Kartonnen stuksverpakking (2)

FR

- Lampe halogène 50 watt
- Boîtier métallique disponible en argent ou noire (1)
- Emballage en carton individuel (2)

ES

- Foco halógena 50 vatios
- Carcasa metálica disponible en plata o negro (1)
- Envase en cartón individual (2)



Art. nr.	BLH35
Colour temperature	3000 kelvin
Light brightness	400 lumen
Power consumption	35 watt
Length power cable	280 cm
Consistent burning hours	2000 hours

Art. nr. silver	BLH50S
Art. nr. black	BLH50B
Colour temperature	3000 kelvin
Light brightness	500 lumen
Power consumption	50 watt
Length power cable	350 cm
Consistent burning hours	2000 hours



Colour temperature 4200 kelvin
Light brightness 1100 lumen

Power consumption 11 watt
Equivalent to halogen 110 watt

Length power cable 350 cm
Consistent burning hours 7000 hours

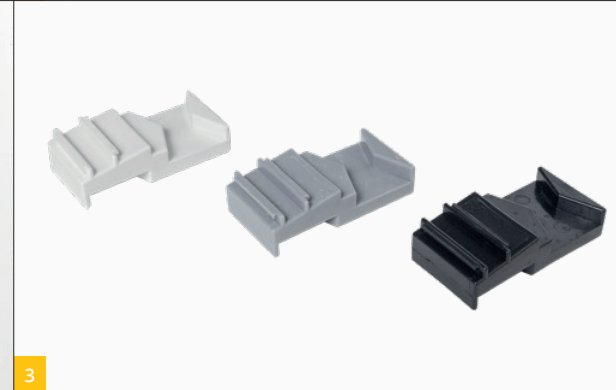

Art. nr.
Colour
 WLED50B ●
 WLED50S ●
 WLED50W ○

All sizes in cm.

Package See fig. 1b on page 3

W	H	D	KG	⊗ in ⊕	⊗ in ⊕
32	93	56	16	10	30
32	93	56	16	10	30
32	93	56	16	10	30

Lighting Wall LED 50

EN

- 50 bright LEDs
- Metal casing in white, silver or black
- Single piece cardboard packaging (1)
- 1 m power cable + 2,5 m extension cord (2)
- Including connector suitable on every Pop-Up (3) and connector suitable on several exhibition stands (4)
- **Optional:** Y-cable connects 2 WLED 50. Maximum capacity is 10 x WLED 50 on 1 power socket (5)

DE

- 50 helle LEDs
- Metallgehäuse verfügbar in weiß, silber oder schwarz
- Einzelstück Kartonverpackung (1)
- 1 m Stromkabel + 2,5 m Verlängerungskabel (2)
- Inklusive Verbindungsteil passend auf jedes Pop-Up (3) und Verbindungsteil passend auf viele Messestände (4)
- **Optional:** Y-Kabel verbindet 2 WLED 50. Maximale Kapazität 10 x WLED 50 auf 1 Strompunkt (5)

NL

- 50 heldere LEDs
- Metalen behuizing verkrijgbaar in wit, zilver of zwart
- Kartonnen stuksverpakking (1)
- 1 m stroomkabel + 2,5 m verlengkabel (2)
- Inclusief verbingsdeel passend op iedere Pop-Up (3) en verbingsdeel passend op veel beursstands (4)
- **Optioneel:** Y-kabel verbindt 2 WLED 50. Maximale capaciteit is 10 x WLED 50 op 1 aansluitpunt (5)

FR

- 50 LEDs puissantes
- Boitier métallique disponible en blanc, argent ou noir
- Emballage par carton individuel (1)
- Cable d'alimentation 1 m + cable d'extension 2,5 m (2)
- Connexion adaptable sur tous les Pop-Up (3) et connexion adaptable sur de nombreux stands de salon (4) inclus
- **Optionnel :** Cable-Y permettant de connecter 2 WLED 50. Capacité maximale de 10 x WLED 50 sur 1 prise (5)

ES

- 50 LED brillantes
- Carcasa metálica disponible en blanco, plata o negro
- Envase en cartón individual (1)
- Cable de alimentación 1 m + cable de extensión 2,5 m (2)
- Incluido un acoplamiento indicado para todos los Pop-Up (3) y un acoplamiento indicado para múltiples stands (4)
- **Opcional:** Cable-Y conecta 2 WLED 50. Capacidad máximo 10 x WLED 50 en 1 solo enchufe (5)



Lighting Wall LED 116

EN

- 116 bright LEDs
- Metal casing available in silver or black
- Single piece cardboard packaging (1)
- 1 m power cable + 2,5 m extension cord (2)
- Including connector suitable on every Pop-Up (3) and connector suitable on several exhibition stands (4)
- **Important:** Double portal of WLED 116 enables interconnection. Maximum capacity is 10 x WLED 116 on 1 power socket

DE

- 116 helle LEDs
- Metallgehäuse verfügbar in silber oder schwarz
- Einzelstück Kartonverpackung (1)
- 1 m Stromkabel + 2,5 m Verlängerungskabel (2)
- Inklusive Verbindungsteil passend auf jedes Pop-Up (3) und Verbindungsteil passend auf viele Messestände (4)
- **Wichtig:** Doppelter Stromanschluss bietet die Option WLED 116 miteinander zu verbinden. Maximale Kapazität sind 10 x WLED 116 pro Strompunkt

NL

- 116 heldere LEDs
- Metalen behuizing verkrijgbaar in zilver of zwart
- Kartonnen stuksverpakking (1)
- 1 m stroomkabel + 2,5 m verlengkabel (2)
- Inclusief verbindingsdeel passend op iedere Pop-Up (3) en verbindingsdeel passend op veel beursstands (4)
- **Belangrijk:** Dubbele stekkerpoort biedt optie tot onderlinge verbinding van WLED 116. Maximale capaciteit 10 x WLED 116 op 1 aansluitpunt

FR

- 116 LEDs puissantes
- Boîtier métallique disponible en blanc, argent ou noir
- Emballage par carton individuel (1)
- Câble d'alimentation 1 m + câble d'extension 2,5 m (2)
- Connexion adaptable sur tous les Pop-Up (3) et connexion adaptable sur de nombreux stands de salon (4) inclus
- **Important :** Double port de connection sur le WLED 116 qui permet une interconnection. Capacité maximale de 10 x WLED 116 sur 1 prise

ES

- 116 LED brillantes
- Carcasa metálica disponible en plata o negro
- Envase en cartón individual (1)
- Cable de alimentación 1 m + cable de extensión 2,5 m (2)
- Incluido un acoplamiento indicado para todos los Pop-Up (3) y un acoplamiento indicado para múltiples stands (4)
- **Importante:** Doble portal del WLED 116 permite entrelazar. Capacidad máximo 10 x WLED 116 en 1 solo enchufe



Position power plug: Backside

Colour temperature 4200 kelvin
Light brightness 2600 lumen

Power consumption 25 watt
Equivalent to halogen 250 watt

Length power cable 350 cm
Consistent burning hours 7000 hours



Position power plug: Left & right side

Package See fig. 1b on page 3

W	H	D	KG	⊗ in ⊕	⊗ in ⊙
34	65	92	22	10	20
34	65	92	22	10	20
34	65	92	22	10	20
34	65	92	22	10	20

Art. nr.	Colour	Position power plug
WLED1160B-BACK	●	Backside
WLED116B-SIDE	●	Left / Right
WLED116S-BACK	●	Backside
WLED116S-SIDE	●	Left / Right

All sizes in cm.

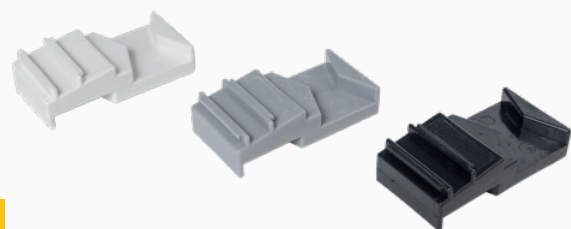

Lighting **Wall Light Halogen 150 Watt**

EN

- 150 watt halogen light
- Metal casing available in silver or black
- Single piece cardboard packaging (1)
- Including connector suitable on every Pop-Up (2) and connector suitable on several exhibition stands (3)

DE

- Halogenlampe 150 Watt
- Metallgehäuse verfügbar in silber oder schwarz
- Einzelstück Kartonverpackung (1)
- Inklusive Verbindungsteil passend auf jedes Pop-Up (2) und Verbindungsteil passend auf viele Messestände (3)

NL

- 150 watt halogeenlamp
- Metalen behuizing verkrijgbaar in zilver of zwart
- Kartonnen stuksverpakking (1)
- Inclusief verbindingsdeel passend op iedere Pop-Up (2) en verbindingsdeel passend op veel beursstands (3)

FR

- Lampe halogène 150 watt
- Boîtier métallique disponible en argent ou noir
- Emballage par carton individuel (1)
- Connexion adaptable sur tous les Pop-Up (2) et connexion adaptable sur de nombreux stands de salon (3) inclus

ES

- Foco halógena 150 vatios
- Carcasa metálica disponible en plata o negro
- Envase en cartón individual (1)
- Incluido un acoplamiento indicado para todos los Pop-Up (2) y un acoplamiento indicado para múltiples stands (3)

Colour temperature 3000 kelvin
Light brightness 1000 lumen

Power consumption 150 watt
Length power cable 350 cm
Consistent burning hours 1000 hours

Art. nr. Colour

WLH150B ●
WLH150S ●

All sizes in cm.

Package See fig. 1b on page 3

W	H	D	KG	⊗ in (Y)	⊗ in (Z)
34	55	95	25	10	30
34	55	95	25	10	30



Luxurious Light Bag

- EN Suitable for storing 3 lights
- DE Zum aufbewahren von 3 Lampen
- NL Geschikt voor opbergen van 3 lampen
- FR Convient pour contenir 3 lampes
- ES Apropiado para guardar 3 luces



Art. nr.	Product	Suitable light types	W	H	D
L-BAG-M	Luxurious Light Bag M	BLED, BLH35, BLH50, WLED50	16	56	12
L-BAG-L	Luxurious Light Bag L	WLED116, WLH150	16	68	13,5

All sizes in cm.

Banner Light Clip

- EN Suitable for any banner type due to universal clip
- DE Geeignet für alle Banner-Systeme mittels Universalklemme
- NL Geschikt voor iedere banner dankzij universele klem
- FR Adaptable à toutes les bannières grâce au clip universel
- ES Adecuado para todo tipo de banner con la pinza universal



Art. nr.
BLC



Wall Light Clamp Tube

- EN Tube clamp for \varnothing 30 - 34 mm tubes
- DE Rohrklemme für \varnothing 30 - 34 mm Rohre
- NL Buis klem voor buizen van \varnothing 30 - 34 mm
- FR Fixation pour tubes de \varnothing 30 - 34 mm
- ES Abrazadera para tubos de \varnothing 30 - 34 mm

Art. nr. Colour
 WLCTB ●
 WLCTW ○
 WLCTS ●



Wall Light Clamp Wall

- EN Wall clamp up to max 53 mm
- DE Wandklemme bis max. 53 mm
- NL Wandklem tot maximaal 53 mm
- FR Fixation murale max. 53 mm
- ES Abrazadera de pared 53 mm máx.

Art. nr. Colour
 WLCWB ●
 WLCWW ○
 WLCWS ●



Counters

Promotional	106
Professional Original M	108
Professional Original L	110
Professional Square	112
Professional Round	114
Fabric	116
Flex Counter	118

5 YEAR
WARRANTY
★★★★★



Counter **Promotional**

EN

- Completely (de)mountable in parts (1)
- Strong support shelf (2)
- Click and mount system (3)
- Braced transporter bag (4)

DE

- Komplett demontierbar (1)
- Starker Einlegeboden mit Stützfunktion (2)
- Klick-Montagesystem (3)
- Verstärkte Transporttasche (4)

NL

- Volledig demonteerbaar in losse onderdelen (1)
- Stevige legplank (2)
- Klik montagesysteem (3)
- Verstevigde transporttas (4)

FR

- Entièrement démontable (1)
- Étagère robuste (2)
- Système 'cliper et monter' (3)
- Sac de transport renforcé (4)

ES

- Completamente desmontable (1)
- Estante de soporte sólido (2)
- Sistema de montaje 'click and go' (3)
- Bolsa de transporte reforzada (4)

Art. nr.

CPRM

All sizes in cm.

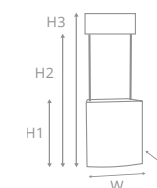

Dimensions

W	H1	H2	H3	D
82	90	185	215	47

Package *See fig. 1a on page 3*

W	H	D	KG
13	94	87	11

Pallet capacity *See fig. 2a on page 3*

Euro	Industrial
12	20

Max. pcs. on pallet

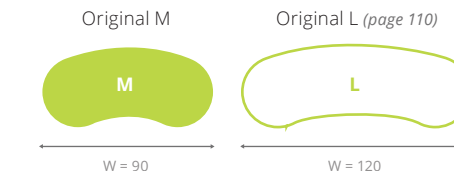

IMPROVED
Improved canal structure sheet for better shapening

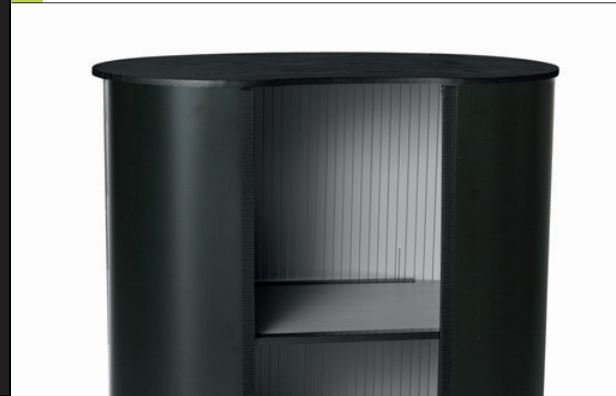
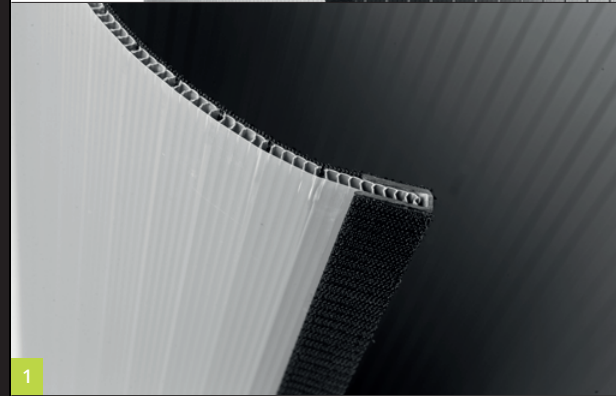

Art. nr. CPOMSHELF Product Plastic Shelf (4)

Counter **Professional Original M**

- EN**
- Extremely stable because of curved shape
 - Canal structure sheet, with black hook velcro (hard) (1)
 - Table top available in: black / wood / silver / white (2)
 - Padded bag for table tops and cylindrical bag with cardboard tube for plastic roll and print (3)
 - **Optional:** Plastic shelf (4)

- DE**
- Extrem stabil mit hoher Standfestigkeit aufgrund gekrümmter Form
 - Lamellenbahn mit Hakenband (1)
 - Thekenplatte verfügbar in: schwarz / holz / silber / weiß (2)
 - Tasche mit Innenfutter für Holzplatten und Köchertasche mit Papprolle für Kunststoffrolle und Druck (3)
 - **Optionel :** Kunststoffeinlegeplatte (4)

- NL**
- Extreem stabiel door gebogen vorm
 - Lamellenrol met haak klittenband (hard) (1)
 - Balieblad beschikbaar in: zwart / hout / zilver / wit (2)
 - Tas met binnenvoering t.b.v. houten bladen en kokertas met kartonnen koker t.b.v. kunststof rol en print (3)
 - **Optioneel:** Kunststof legplank (4)

- FR**
- Extrêmement stable grâce à sa forme courbée
 - Structure alvéolaire avec velcro (côté dur) (1)
 - Tablette supérieure disponible en: noir / bois / argent / blanc (2)
 - Sac renforcé avec rangement pour tablettes ainsi qu'un sac en cylindre avec tubes en carton pour les imprimés et les rouleaux plastiques (3)
 - **Optionnel :** Étagère en plastique (4)

- ES**
- Extremadamente estable por su forma curva
 - Estructura laminar con velcro de gancho (cara dura) (1)
 - Tablero disponible en: negro / madera / gris plateado / blanco (2)
 - Bolsa acolchada para los tableros y bolsa cilíndrica con tubo de cartón para el material plástico e impresión (3)
 - **Opcional:** Estante plástico (4)

Art. nr.	Colour	Dimensions			Package <i>See fig. 1a on page 3</i>					Pallet capacity <i>See fig. 2a on page 3</i>	
		W	H	D	W	H	D	KG	(X) in (Y)	Euro	Industrial
CPOMTTB	●	91	93	48	50	93	40	30	2	16	24
CPOMTTW	●	91	93	48	50	93	40	30	2	16	24
CPOMTTS	●	91	93	48	50	93	40	30	2	16	24
CPOMTTWH	○	91	93	48	50	93	40	30	2	16	24

All sizes in cm.

Max. pcs. on pallet

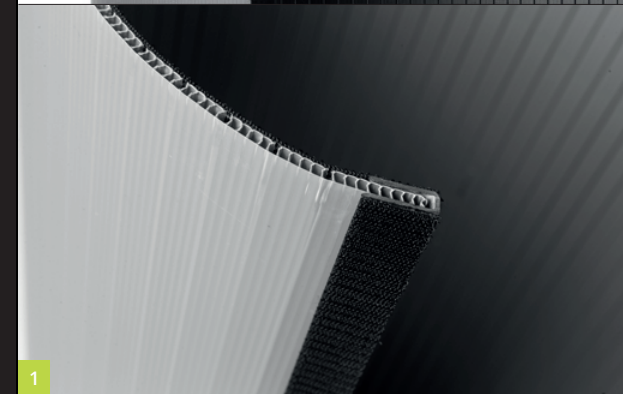

1

2

3: Optional

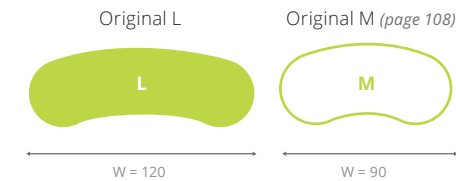

Counter Professional Original L

EN

- Extremely stable because of curved shape
- Canal structure sheet, with black hook velcro (hard) (1)
- Black table top
- Padded bag for table tops and cylindrical bag with cardboard tube for plastic roll and print (2)
- **Optional:** Wooden shelf (3)

DE

- Extrem stabil mit hoher Standfestigkeit aufgrund gekrümmter Form
- Lamellenbahn mit Hakenband (1)
- Schwarze Thekenplatte
- Tasche mit Innenfutter für Holzplatten und Köchertasche mit Papprolle für Kunststoffrolle und Druck (2)
- **Optionel:** Einlegeplatte aus Holz (3)

FR

- Stabilité renforcée grâce à sa forme courbée
- Structure alvéolaire avec velcro (côté dur) (1)
- Tablette supérieure noir
- Sac renforcé avec rangement pour tablettes ainsi qu'un sac en cylindre avec tubes en carton pour les imprimés et les rouleaux plastiques (2)
- **Optionnel :** Étagère en bois (3)

NL

- Extreem stabiel door gebogen vorm
- Lamellenrol met haak klittenband (hard) (1)
- Zwart balieblad
- Tas met binnenvoering t.b.v. houten bladen en kokertas met kartonnen koker t.b.v. kunststof rol en print (2)
- **Optioneel:** Houten legplank (3)

ES

- Extremadamente estable por su forma curvada
- Estructura laminar con velcro de gancho (cara dura) (1)
- Tablero de mesa negro
- Bolsa acolchada para los tableros y bolsa cilíndrica con tubo de cartón para el material plástico e impresión (2)
- **Opcional:** Estante de madera (3)

Art. nr.
CPOLSHLF

Product
Wooden Shelf (3)

Art. nr.

Colour

CPOLTTB

●

All sizes in cm.

Dimensions

W	H	D
120	93	48

Package

See fig. 1a on page 3

	W	H	D	KG
Table top:	22	22	93	3
Canal structure:	50	9	123	12

Pallet capacity

See fig. 2a on page 3

Euro	Industrial
13	20

Max. pcs. on pallet

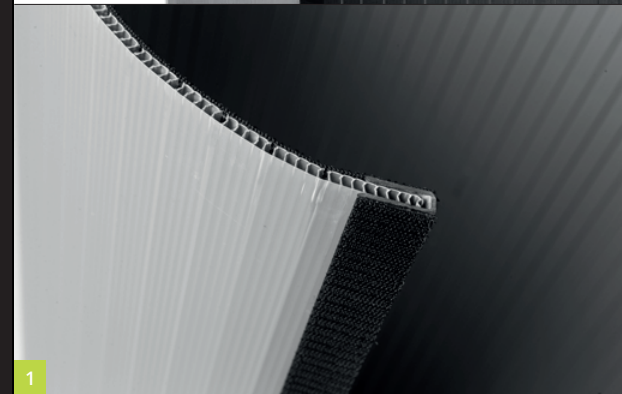

1



2



3: Optional



Art. nr.
CPSSHELF

Product
Plastic Shelf (3)

Counter Professional Square

EN

- Canal structure sheet, with black hook velcro (hard) (1)
- Black table top
- Padded bag for table top and cylindrical bag with cardboard tube for plastic roll and print (2)
- **Optional:** Plastic shelf (3)

DE

- Lamellenbahn mit Hakenband (1)
- Schwarze Thekenplatte
- Tasche mit Innenfutter für Holzplatten und Köchertasche mit Papprolle für Kunststoffrolle und Druck (2)
- **Optional:** Kunststoffeinklegeplatte (3)

NL

- Lamellenrol met haak klittenband (hard) (1)
- Zwart balieblad
- Tas met binnenvoering t.b.v. houten bladen en kokertas met kartonnen koker t.b.v. kunststof rol en print (2)
- **Optioneel:** Kunststof legplank (3)

FR

- Structure alvéolaire avec velcro (côté dur) (1)
- Tablette supérieure noire
- Sac renforcé avec rangement pour tablettes ainsi qu'un sac en cylindre avec tubes en carton pour les imprimés et les rouleaux plastiques (2)
- **Optionnel :** Étagère en plastique (3)

ES

- Estructura laminar con velcro de gancho (cara dura) (1)
- Tablero de mesa negro
- Bolsa acolchada para los tableros y bolsa cilíndrica con tubo de cartón para el material plástico e impresión (2)
- **Opcional:** Estante plástico (3)

Art. nr.
CPSTTB

Colour
●

All sizes in cm.

Dimensions

W	H	D
100	93	40

Package See fig. 1a on page 3

W	H	D	KG	X in Y
45	45	105	31,5	2

Pallet capacity See fig. 2a on page 3

Euro	Industrial
10	20

Max. pcs. on pallet

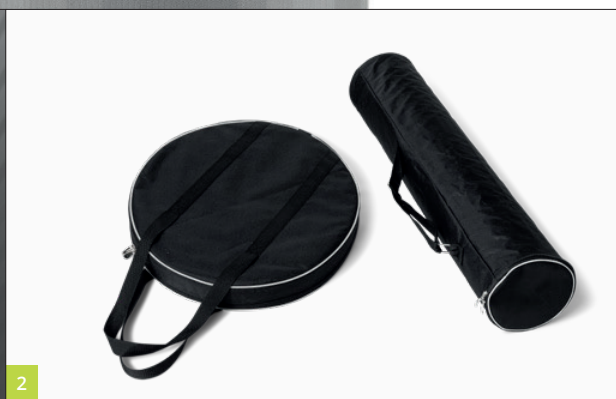
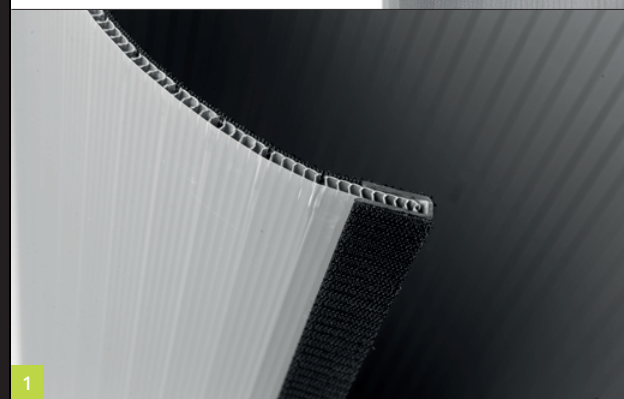

Counter **Professional Round**

EN

- Extremely stable because of round shape
- Canal structure sheet, with black hook velcro (hard) (1)
- Black table top
- Padded bag for table top and cylindrical bag with cardboard tube for plastic roll and print (2)

DE

- Extrem stabil mit hoher Standfestigkeit aufgrund von runder Form
- Lamellenbahn mit Hakenband (1)
- Schwarze Thekenplatte
- Tasche mit Innenfutter für Holzplatten und Köchertasche mit Papprolle für Kunststoffrolle und Druck (2)

NL

- Extreem stabiel door ronde vorm
- Lamellenrol met haak klittenband (hard) (1)
- Zwart balieblad
- Tas met binnenvoering t.b.v. houten bladen en kokertas met kartonnen koker t.b.v. kunststof rol en print (2)

FR

- Stabilité renforcée grâce à sa forme courbée
- Structure alvéolaire avec velcro (côté dur) (1)
- Tablette supérieure noire
- Sac renforcé avec rangement pour tablettes ainsi qu'un sac en cylindre avec tubes en carton pour les imprimés et les rouleaux plastiques (2)

ES

- Extremadamente estable por su forma curva
- Estructura laminar con velcro de gancho (cara dura) (1)
- Tablero de mesa negro
- Bolsa acolchada para los tableros y bolsa cilíndrica con tubo de cartón para el material plástico e impresión (2)

Art. nr. Colour

CPRTTB ●

All sizes in cm.

Dimensions

Ø	H
45	93

Package *See fig. 1a on page 3*

W	H	D	KG	ⓧ in Ⓨ
48	30	97	16	2

Pallet capacity *See fig. 2a on page 3*

Euro	Industrial
24	32

Max. pcs. on pallet



6: Optional

Optional velcro (6)

Product Velcro Loop (soft side)
 Art. nr. VEL50L
 Width 50mm
 Length 25m



Counter Fabric

EN

- Matt black powder coated aluminium frame (1)
- Wooden shelf in the same colour as table top (2)
- Table top available in: black / wood / silver / white (3)
- Trolley with zipper over full length (4)
- Wide wheel base with ball bearing wheels (5)
- **Optional:** Loop velcro (soft side) available (6)

DE

- Mattschwarzer pulverbeschichteter Aluminiumrahmen (1)
- Einlegeplatte aus Holz in Farbe der Thekenplatte (2)
- Thekenplatte verfügbar in: schwarz / holz / silber / weiß (3)
- Trolley mit Reißverschluss über die ganze Taschenlänge (4)
- Breiter Radstand mit kugelgelagerten Rädern (5)
- **Optional:** Flauschband erhältlich (6)

NL

- Matzwart gepoedercoat aluminium frame (1)
- Houten legplank in dezelfde kleur als balieblad (2)
- Balieblad beschikbaar in: zwart / hout / zilver / wit (3)
- Trolley met ritssluiting over volledige lengte (4)
- Brede wielbasis met kogelgelagerde wielen (5)
- **Optioneel:** Lus klittenband (zachte kant) beschikbaar (6)

FR

- Structure aluminium revêtement poudre noir (1)
- Étagère en bois de la même couleur que la tablette (2)
- Tablette supérieure disponible en: noir / bois / argent / blanc (3)
- Valise avec fermeture éclair sur toute la longueur (4)
- Roues situées de chaque côtés dotées de roulement à billes (5)
- **Optionnel :** Côté souple velcro (femelle) disponible (6)

ES

- Marco de aluminio lacado, color negro mate (1)
- Estante de madera del mismo color que el tablero (2)
- Tablero disponible en: negro / madera / gris plateado / blanco (3)
- Trolley con cremallera en todo la longitud (4)
- Amplia distancia entre ruedas con rodamientos de bolas (5)
- **Opcional:** Velcro de bucle (cara suave) disponible (6)

Art. nr.	Colour
CFTTB	●
CFTTW	●
CFTTS	●
CFTTWH	○

All sizes in cm.

Dimensions

W	H	D
106	102	40
106	102	40
106	102	40
106	102	40

Package See fig. 1a on page 3

W	H	D	KG
45	115	26	18
45	115	26	18
45	115	26	18
45	115	26	18

Pallet capacity See fig. 2a on page 3

Euro	Industrial
13	14
13	14
13	14
13	14

Max. pcs. on pallet



1



2



3



4



5: Optional



Optional PVC Panels for new visuals (5)

Product 8 extra PVC panels
Art. nr. FLP-SET

Counter Flex

EN

- Completely foldable aluminium frame (1)
- White table top (2)
- Including 8 translucent PVC panels (3)
- Padded trolley with cover to protect panels and prints (4)
- **Optional:** 8 extra PVC panels for new visuals (5)

DE

- Vollständig einklappbarer Aluminiumrahmen (1)
- Weiße Thekenplatte (2)
- Inklusive 8 durchsichtige PVC Paneele (3)
- Gepolsterter Trolley mit Schutz für Paneele und Drucke (4)
- **Optional:** 8 zusätzliche PVC-Paneele für neue Drucke (5)

NL

- Volledig inklapbaar aluminium frame (1)
- Wit balieblad (2)
- Inclusief 8 transparante PVC panelen (3)
- Gevoerde trolley met hoes voor bescherming panelen en prints (4)
- **Optioneel:** 8 extra PVC panelen voor nieuwe prints (5)

FR

- Cadre aluminium entièrement repliable (1)
- Tablette supérieure blanche (2)
- Inclus 8 panneaux transparents (3)
- Sac de transport matelassé avec protections individuelles pour les panneaux et impressions (4)
- **Optionnel :** 8 panneaux en PVC supplémentaires pour les visuels nouveaux (5)

ES

- Estructura de aluminio completamente plegable (1)
- Tablero de mesa blanco (2)
- Incluye 8 paneles translúcidos de PVC (3)
- Trolley acolchado con cubierta para proteger los paneles e impresiones (4)
- **Opcional:** 8 paneles de PVC adicionales para nuevas impresiones (5)

Art. nr.

FLC

All sizes in cm.

Dimensions

Ø	H
58	106

Package See fig. 1a on page 3

W	H	D	KG
63	23	70	17

Pallet capacity See fig. 2a on page 3

Euro	Industrial
15	18

Max. pcs. on pallet

Flex Tower

Flex Tower

122



5 YEAR
WARRANTY
★★★★★



1



2



3



4



5



Optional PVC Panels for new visuals (5)

Product Art. nr. 8 extra PVC panels FLP-SET

Flex Tower

EN

- Completely foldable aluminium frame (1)
- Translucent shelves, max 5 kg
- Including 16 translucent PVC panels (2)
- Built in 15 watt LED spotlight for an eye-catching light effect (3)
- Padded trolley with cover to protect panels and prints (4)
- **Optional:** 8 extra PVC panels for new visuals (5)

DE

- Vollständig einklappbarer Aluminiumrahmen (1)
- Durchsichtige Einlegeplatten, max. 5 kg
- Inklusive 16 durchsichtige PVC Paneele (2)
- 15 Watt LED-Einbauspot für auffällige Lichteffekte (3)
- Gepolsterter Trolley mit Schutz für Paneele und Drucke (4)
- **Optional:** 8 zusätzliche PVC-Paneele für neue Drucke (5)

NL

- Volledig inklapbaar aluminium frame (1)
- Transparante legplaten, max 5 kg
- Inclusief 16 transparante PVC panelen (2)
- Ingebouwde 15 watt LED spot voor een opvallend lichteffect (3)
- Gevoerde trolley met hoes voor bescherming panelen en prints (4)
- **Optioneel:** 8 extra PVC panelen voor nieuwe prints (5)

FR

- Cadre aluminium entièrement repliable (1)
- Étagères transparentes, max 5 kg
- Inclus 16 panneaux transparents (2)
- Spot 15 watts LED intégré pour éclairer les produits (3)
- Sac de transport matelassé avec protections individuelles pour les panneaux et impressions (4)
- **Optionnel :** 8 panneaux en PVC supplémentaires pour les visuels nouveaux (5)

ES

- Estructura de aluminio completamente plegable (1)
- Estantes translúcidos, máx 5 kg
- Incluye 16 paneles translúcidos de PVC (2)
- Incluye proyector LED de 15 vatios llamativo efecto de luz (3)
- Trolley acolchado con funda para la protección de los paneles e impresiones (4)
- **Opcional:** 8 paneles de PVC adicionales para nuevas impresiones (5)

Art. nr.

FLTWR

All sizes in cm.

Dimensions

Ø	H
57	206

Package

W	H	D	KG
61	28	68	25.5

Pallet capacity See fig. 2a on page 3

Euro	Industrial
12	15

Max. pcs. on pallet

Brochure Holders

Magnetic	126
Budget	128
Easy	130
ZigZag	132
Deluxe	134

5 YEAR
WARRANTY
★★★★★

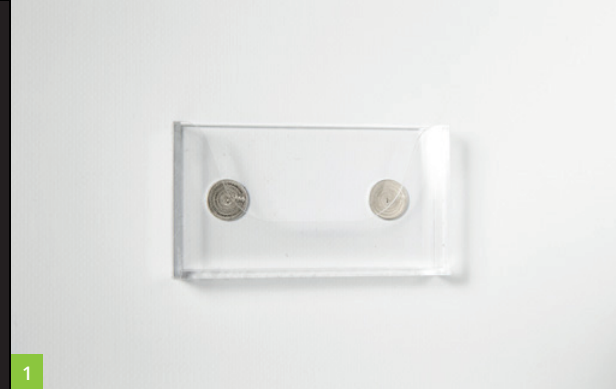

1



3



2



4



Brochure Holder **Magnetic**

EN

- Size: Business card (1)
- Size: DIN long (2)
- Size: A5 (3)
- Size: A4 (4)
- Attached to banner with two pairs of powerful disk magnets

DE

- Format: Visitenkarte (1)
- Format: DIN lang (2)
- Format: A5 (3)
- Format: A4 (4)
- Mit zwei kraftvollen Scheibenmagneten am Banner befestigt

NL

- Formaat: Visitekaartje (1)
- Formaat: DIN lang (2)
- Formaat: A5 (3)
- Formaat: A4 (4)
- Bevestigd aan de banner met twee paar krachtige schijfmagneten

FR

- Format: Carte de visite (1)
- Format: DIN long (2)
- Format: A5 (3)
- Format: A4 (4)
- Suspendu au banner par deux paires de aimants puissants

ES

- Tamaño: Tarjeta de visita (1)
- Tamaño: DIN largo (2)
- Tamaño: A5 (3)
- Tamaño: A4 (4)
- Unido al banner con dos pares de imanes potentes en forma de disco

Art. nr.	Size
BHMB	Business card
BHMDIN	Din long
BHMA5	A5
BHMA4	A4

All sizes in cm.

Dimensions

W	H	D	Magnets
9.5	5	1.1	Ø 15x2 mm
11.5	20.5	1.1	Ø 15x2 mm
16.5	20.5	1.5	Ø 15x2 mm
23	29.5	1.8	Ø 18x3 mm

Package *See fig. 1b on page 3*

W	H	D	KG	⊗ in ⊙	⊗ in ⊚
14	59	22	6	20	100
16	116	24	10	10	50
21	116	24	11	10	50
28	151	31	25	10	50

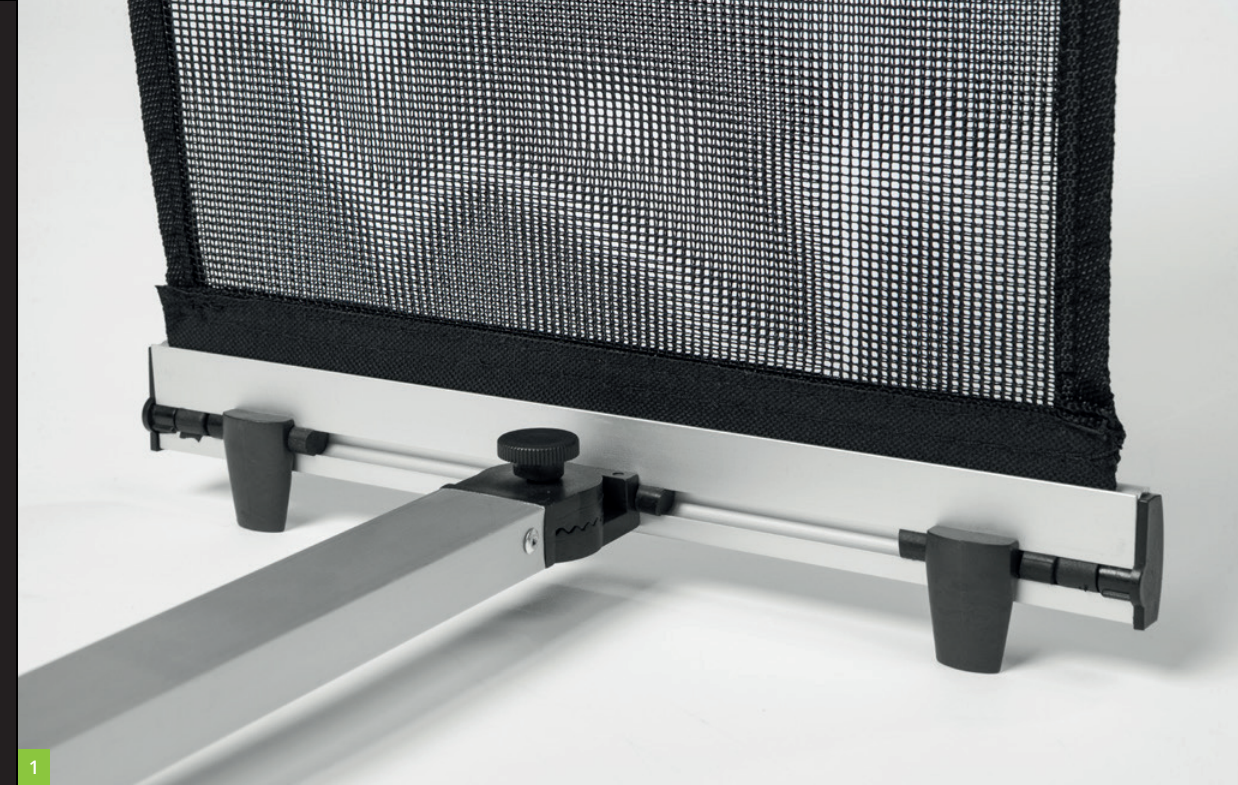

Brochure Holder **Budget**

EN

- Screwed twist-foot (1)
- Padded bag with zipper (2)

DE

- Verschraubter Schwenkfuß (1)
- Tasche mit Innenfutter und Reißverschluss (2)

NL

- Geschroefde draaivoet (1)
- Tas met binnenvoering en ritssluiting (2)

FR

- Pieds à fermeture vissé (1)
- Sac renforcé avec fermeture éclair (2)

ES

- Pie giratorio atornillado (1)
- Bolsa acolchada con cremallera (2)

Art. nr.

BHB4
BHB8

All sizes in cm.

Dimensions

Size	W	H	D
A4 (Single)	27	135	41
A4 (Double)	51	135	41

Package See fig. 1a on page 3

W	H	D	KG	⊗ in ⊙
45	19	60	12	10
45	19	60	15	10

Pallet capacity See fig. 2a on page 3

Euro	Industrial
350	400
350	400

Max. pcs. on pallet



1



2

Brochure Holder **Easy**

EN

- Padded bag with zipper (1)
- Single piece cardboard packaging (2)

DE

- Tasche mit Innenfutter und Reißverschluss (1)
- In Einzelkartonagen verpackt (2)

NL

- Tas met binnenvoering en ritssluiting (1)
- Kartonnen stuksverpakking (2)

FR

- Sac renforcé avec fermeture éclair (1)
- Emballage en carton individuel (2)

ES

- Bolsa acolchada con cremallera (1)
- Embalaja en cartón individual (2)

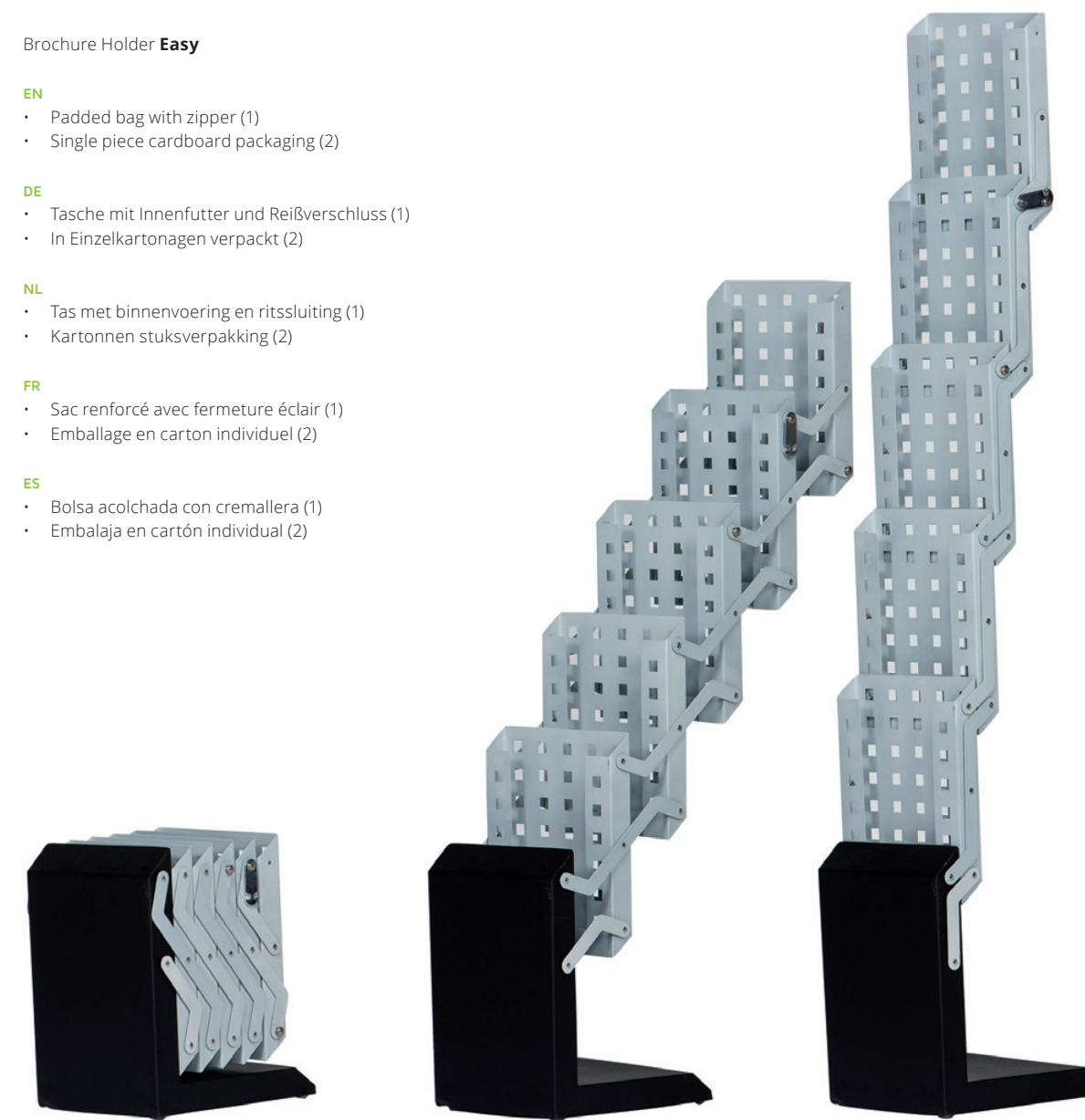

Art. nr.

BHE5

All sizes in cm.

Dimensions

W	H	D
24	144	30

Package *See fig. 1a on page 3*

W	H	D	KG	⊗ in ⊙
62	79	31	24	3

Pallet capacity *See fig. 2a on page 3*

Euro	Industrial
40	60

Max. pcs. on pallet



1



2



3

Brochure Holder **ZigZag**

EN

- Easy build up
- Aluminium frame with screwed connections (1)
- Equipped with 4 rubber feet (2)
- Solid case with foam with protection inside (3)

DE

- Einfach aufzubauen
- Aluminiumrahmen mit Schraubverbindungen (1)
- Ausgestattet mit 4 Gummifüßen (2)
- Solider Transportkoffer mit Schaumstoffpolsterung auf der Innenseite (3)

NL

- Eenvoudige opbouw
- Aluminium frame met geschroefde verbindingen (1)
- Voorzien van 4 rubberen voetjes (2)
- Transportkoffer met schuimbescherming aan binnenkant (3)

FR

- Montage facilité
- Cadre en aluminium équipé de joints vissés (1)
- Équipé de 4 pieds en caoutchouc (2)
- Valise de transport robuste avec intérieur en mousse (3)

ES

- Fácil de montar
- Estructura de aluminio con conexiones roscadas (1)
- Equipado con 4 pies de goma (2)
- Maleta resistente con protección interior de gomaespuma (3)



Format A4
Tray depth 2,5cm

Art. nr.	Type
BHZZW	Wood
BHZZA	Acrylic
BHZZM	Matt

All sizes in cm.

Dimensions

W	H	D
28	143	35
28	143	35
28	143	35

Package *See fig. 1a on page 3*

W	H	D	KG	⊗ in ⊙
49	55	37	27	3
49	55	37	27	3
49	55	37	27	3

Pallet capacity *See fig. 2a on page 3*

Euro	Industrial
48	52
48	52
48	52

Max. pcs. on pallet

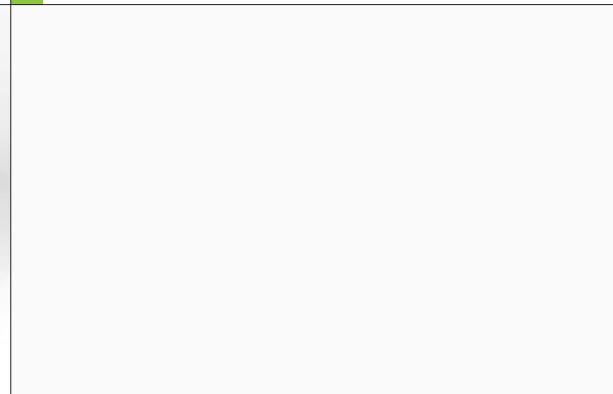
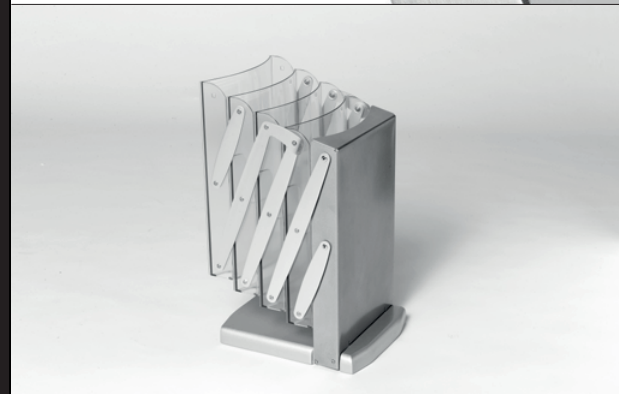

Brochure Holder **Deluxe**

EN

- Extremely stable brochure holder
- Easy build up
- Heavy duty base (1)
- Reinforced padded bag with zipper (2)

DE

- Sehr stabiler Prospekthalter
- Einfach aufzubauen
- Schwerlastfuß (1)
- Verstärkte gefütterte Tasche mit Reißverschluss (2)

NL

- Zeer stabiele brochurehouder
- Eenvoudige opbouw
- Stevige basis (1)
- Verstevigde gevoerde tas met ritssluiting (2)

FR

- Porte brochure extrêmement stable
- Montage facilité
- Base lourde (1)
- Sac renforcé et rembourré avec fermeture éclair (2)

ES

- Portafolletos extremadamente estable
- Fácil de montar
- Base sólida (1)
- Bolsa acolchada reforzada con cremallera (2)

Format A4
Tray depth 5cm

Art. nr.

BHL

All sizes in cm.

Dimensions

W	H	D
24	156	29

Package See fig. 1a on page 3

W	H	D	KG	⊗ in ⊙
33	54	34	8	1

Pallet capacity See fig. 2a on page 3

Euro	Industrial
24	36

Max. pcs. on pallet

Poster Holders

Poster Rail	138
Poster Frame	140
Poster Stand	142

5 YEAR
WARRANTY
★★★★★



1



Poster Rail

EN

- Aluminium poster rail in 7 different width sizes
- Snap-action rail on top and bottom
- Easily interchangeable prints
- Wall or ceiling mounted
- Single piece packaging
- Including 2 hooks, screws and plugs (1)

DE

- Aluminium-Klapprahmen in 7 verschiedenen Größen
- Klemmschiene oben und unten
- Drucke einfach auswechselbar
- Befestigung an Wand oder Decke
- Einzelstück Verpackung
- Einschließlich 2 Haken, Schrauben und Dübeln (1)

NL

- Aluminium posterrail in 7 verschillende breedte maten
- Klemprofiel boven en onder
- Makkelijk verwisselbare prints
- Bevestig aan de muur of het plafond
- Stuksverpakking
- Inclusief 2 ophangogen, schroeven en pluggen (1)

FR

- Cadre à clipser en aluminium dans 7 largeurs différentes
- Rail à clips en haut et en bas
- Visuels facilement interchangeables
- Fixé au mur ou au plafond
- Emballage individuel
- 2 œillets de suspension, vis et chevilles inclus (1)

ES

- Perfil de aluminio en 7 anchos diferentes
- Perfil superior e inferior abatible
- Visuales fácilmente intercambiables
- Montaje en muro o techo
- Empaquetado por unidad
- Incluye 2 ganchos, tornillos y tapones (1)

Art. nr.

PR-A4
PR-A3
PR-A2
PR-A1
PR-A0
PR-100
PR-120

All sizes in cm.

Dimensions

W

21
29,7
42
59,4
84,1
100
120



2: Landscape and portrait



3



Poster **Frame**

- EN**
 - Aluminium snap frame in 4 different sizes (1)
 - Width frame: 25 mm
 - Adjustable to landscape & portrait (2)
 - Single piece cardboard packaging
 - Including screws and plugs (3)
- DE**
 - Aluminium-Klapprahmen in 4 verschiedenen Größen (1)
 - Breite des Rahmens: 25 mm
 - Montierbar in Landschaft- und Portraitformat (2)
 - Einzelstück Kartonverpackung
 - Einschließlich Schrauben und Dübeln (3)
- NL**
 - Aluminium kliklijst in 4 verschillende maten (1)
 - Breedte lijst: 25 mm
 - Landscape en portrait monteerbaar (2)
 - Kartonnen stuksverpakking
 - Inclusief schroeven en pluggen (3)
- FR**
 - Cadre à clipser en aluminium dans 4 tailles différentes (1)
 - Largeur de cadre : 25 mm
 - Ajustable en mode paysage ou portrait (2)
 - Emballage par carton individuel
 - Vis et chevilles incluses (3)
- ES**
 - Marco de aluminio en 4 tamaños distintos (1)
 - Ancho del marco: 25 mm
 - Ajustable en posición de paisaje o de retrato (2)
 - Embalaje en cartón individual
 - Incluye tornillos y tapones (3)

Art. nr.

- PF-A4
- PF-A3
- PF-A2
- PF-A1

Dimensions

W	H
21	29,7
29,7	42
42	59,4
59,4	84,1

Package

W	H	D	KG
26	2	34,5	0,6
34,5	2	46,5	0,7
46,5	2	64,5	1,2
64,5	2	89,5	2,1

All sizes in cm.

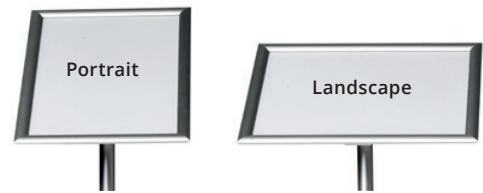

PSA4 & PSA3: Adjustable to landscape & portrait

Poster **Stand**

- EN**
 - Aluminium snap frame A4 or A3 (1)
 - Brochure holder acrylic (2)
 - Adjustable to landscape & portrait (3)
 - Rubber protection under base (4)
 - Easily (de)mountable in parts (5)
 - Padded transporter bag (6)
- DE**
 - Aluminium-Klapprahmen A4 oder A3 (1)
 - Prospekthalter Acryl (2)
 - Montierbar in Landschaft- und Portraitformat (3)
 - Gummischutz am Fuß (4)
 - Einfach zu demontieren (5)
 - Gefütterte Transporttasche (6)
- NL**
 - Aluminium kliklijst A4 of A3 (1)
 - Brochurehouder acryl (2)
 - Landscape en portrait monteerbaar (3)
 - Rubberen bescherming onder voet (4)
 - Eenvoudig demonteerbaar (5)
 - Gevoerde transporttas (6)
- FR**
 - Cadre à clipser A4 ou A3 en aluminium (1)
 - Porte-brochure acrylique (2)
 - Ajustable en mode paysage ou portrait (3)
 - Protection en caoutchouc sous la base (4)
 - Facilement démontable (5)
 - Sac de transport rembourré (6)
- ES**
 - Marco de aluminio A4 o A3 (1)
 - Portafolletos acrílico (2)
 - Ajustable en posición de paisaje o de retrato (3)
 - Base protegida con lámina de goma (4)
 - Fácilmente desmontable (5)
 - Bolsa de transporte acolchada (6)

Dimensions

Art. nr.	Base	H
PSA4	Ø 33	114
PSA3	Ø 33	118
PSA4A	Ø 33	118

All sizes in cm.

Package See fig. 1a on page 3

W	H	D	KG	(X) in (Y)
8	39	36	5	4
8	39	47	5	4
8	39	36	5	4

Pallet capacity See fig. 2a on page 3

Euro	Industrial
120	150
96	120
120	150

Max. pcs. on pallet

Outdoor

Streetboard	146
Outdoor Banner	148

5 YEAR
WARRANTY
★★★★★



Outdoor Banner

EN

- Water tank 18 liter (1)
- Adjustable in height with aluminium clip (2)
- Fiberglass banner holders (3)
- Delivered in 2 braced transporter bags (4)

DE

- Wassertank 18 Liter (1)
- In Höhe verstellbar, mit Aluminium Clip (2)
- Fiberglas-Grifikhalter (3)
- Lieferung in 2 verstärkten Transporttaschen (4)

NL

- Watertank 18 liter (1)
- In hoogte verstelbaar met aluminium clip (2)
- Fiberglas bannerhouders (3)
- Geleverd in 2 verstevigde transporttassen (4)

FR

- Réservoir à eau de 18 litres (1)
- Hauteur ajustable avec clip en aluminium (2)
- Porte-bannière en fibre de verre (3)
- Livré dans 2 sacs de transport renforcés (4)

ES

- Depósito para 18 litros de agua (1)
- Altura ajustable con clip de aluminio (2)
- Portabandera de fibra de vidrio (3)
- Entrega en 2 bolsas de transporte reforzadas (4)



Art. nr.

OB180

All sizes in cm.

Dimensions

W	H
80	180

Package See fig. 1a on page 3

W	H	D	KG	X in Y
40	102	23	8	2

Pallet capacity See fig. 2a on page 3

Euro	Industrial
30	40

Max. pcs. on pallet

Cases

Hard Case	172
Trolley Case	173
Transport Trolley	174
Soft Trolley	175

5 YEAR
WARRANTY
★★★★★



Inner size
65 x 80 cm (W x H)
14 kg

Front side

Back side



- EN**
- Solid twist hinges (1)
 - Carrying grip on side
 - Padded bag and firm divider to protect the print (2)
 - Heavy duty wheels (3)

- DE**
- Starke Drehscharniere (1)
 - Tragegriff an der Seite
 - Tasche mit Innenfutter und Mittelabtrennung zum Schutz der Drucke (2)
 - Massive starke Transporträder (3)

- NL**
- Sterke draaischarnieren (1)
 - Draaghandvat aan zijkant
 - Gevoerde zak en stevig scheidingspaneel voor bescherming print (2)
 - Massieve sterke wielen (3)

- FR**
- Charnières tournantes solides (1)
 - Poignée sur les deux côtés
 - Sac rembourré et séparateur fixe permettant de protéger les visuels imprimés (2)
 - Roues hautement résistantes (3)

- ES**
- Bisagras sólidas (1)
 - Asa de transporte lateral
 - Bolsa acolchada con separador sólido para proteger la impresión (2)
 - Ruedas altamente resistentes (3)



Hard Case

Art. nr.

PUHCL

Package

W	H	D
71	100	41

All sizes in cm.



Inner size medium (M)
33 x 85 x 30 cm (W x H x D)
5 kg

Inner size large (L)
43 x 85 x 30 cm (W x H x D)
5,5 kg

Inner size extra large (XL)
53 x 85 x 30 cm (W x H x D)
6 kg



Case Trolley Case

- EN**
- Extendible trolley handle (1)
 - Wide wheel base with ball bearing wheels (2)

- DE**
- Trolley mit ausziehbarem Griff (1)
 - Breiter Radstand mit kugelgelagerten Rädern (2)

- NL**
- Uitschuifbare trolley handgreep (1)
 - Brede wielbasis met kogelgelagerde wielen (2)

- FR**
- Poignée de valise télescopique (1)
 - Position large dos roues avec roulement à billes (2)

- ES**
- Asa de trolley extensible (1)
 - Ancho de rueda con rodamientos de bolas (2)

Trolley Case

Art. nr.

PUTCM
PUTCL
PUTCXL

Size
M
L
XL

Package

W	H	D
39	98	39
48	98	39
56	98	39

All sizes in cm.





Inner size medium (M)
25 x 119 x 12 cm (W x H x D)
5 kg

Inner size large (L)
25 x 119 x 17 cm (W x H x D)
5,7 kg

Inner size extra large (XL)
25 x 119 x 22 cm (W x H x D)
6,4 kg



1



2

Case **Transport Trolley**

EN

- Reinforced transport trolley for durable professional use (1)
- Solid wheel base with ball bearing wheels (2)

DE

- Verstärkter Transporttrolley für Langzeitgebrauch (1)
- Solide Radbasis mit kugelgelagerten Rädern (2)

NL

- Verstevigde transporttrolley voor langdurig professioneel gebruik (1)
- Solide wielbasis met kogelgelagerde wielen (2)

FR

- Valise de transport robuste pour une utilisation professionnelle durable (1)
- Roues solides avec roulement à billes (2)

ES

- Trolley profesional reforzado para transporte y uso duradero (1)
- Ase sólida con ruedas con rodamientos de bolas (2)

Transport Trolley

Art. nr.	Size	Inner height
TT120M	M	12
TT120L	L	17
TT120XL	XL	22

All sizes in cm.

Package

W	H	D
33	132	19
33	132	23
33	132	28



Inner size
40 x 108 x 23 cm (W x H x D)



1

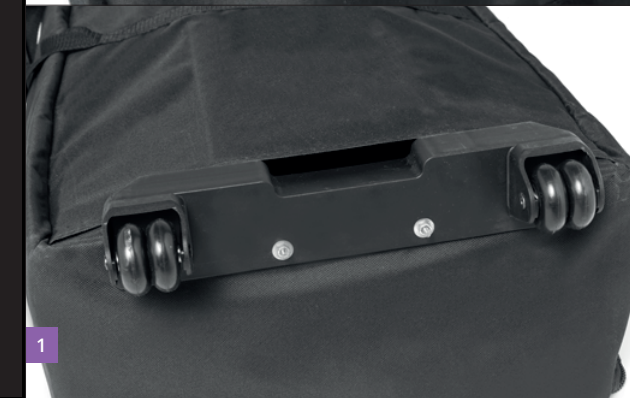

Case **Soft Trolley**

EN

- Extendible trolley handle
- Wide wheel base with ball bearing wheels (1)

DE

- Trolley mit ausziehbarem Griff
- Breiter Radstand mit kugelgelagerten Rädern (1)

NL

- Uitschuifbare trolley handgreep
- Brede wielbasis met kogelgelagerde wielen (1)

FR

- Poignée de valise télescopique
- Roues situées de chaque côtés dotées de roulement à billes (1)

ES

- Asa de trolley extensible
- Ancho de rueda con rodamientos de bolas (1)

Soft Trolley

Art. nr.

ST

All sizes in cm.

Package

W	H	D
46	117	27