

ORIGINAL OPERATING INSTRUCTIONS

Read carefully and retain for future reference



Ceramic Heater

Réf: **AMBIENTE V**



Mod: **AMBIENTE V 1000, AMBIENTE V 1500 & AMBIENTE V 2000**

IMPORTANT WARNINGS

Dear Customer:

Thank you for your confidence in us by purchasing this radiator. These appliances are extremely safe, silent and easy to install.

They do not require special maintenance. They are made of extruded aluminum, a material of high durability respectful to the environment.

Before starting it for the first time, carefully read these instructions.

Retain them for future references.

GENERAL SAFETY INSTRUCTIONS

1. Please read carefully these instructions before starting the device for the first time. Keep these instructions, as well as the guarantee, your invoice and if possible, the complete packing with all the elements inside.
 2. **The guarantee will cease to be valid in the case of not following the recommendations of this manual.**
 3. Before connecting the appliance, make sure the mains voltage is the 230 Volts, and correspond to the marked on the nameplate of the appliance.
 4. Check that the power is sufficient to supply the appliances. The total draw of the radiators' currents must not exceed the capacity of the circuit breaker that protects them.
 5. This radiator cannot be used in rooms with presence of gases or other flammable products (glues, etc...).
 6. **WARNING**: To prevent overheating, do not cover the device. Do not use the device to dry clothes.
 7. Make sure the power cable or other objects do not come into contact with the radiator surface while in operation.
 8. If the power cable becomes damaged it must be replaced by the manufacturer or a suitably qualified trades person. Failure to comply may danger your safety and voids your warranty.
-

9. Check the device and the supply cord regularly. Do not turn the device on if it is damaged.
 10. **PRECAUTION: Some parts of this product can reach very high temperatures and cause burns. Pay special attention when children or vulnerable people are around.**
 11. Do not place the device straight under a power socket.
 12. Children under the age of three should not be allowed to touch or play with the radiator and should be supervised at all times.
 13. This device can be used by children under 8 years of age, as well as by people with reduced physical, sensory or mental capabilities when suitably supervised and only when they have been provided the instructions regarding the use of the device and have understood the risks that could derive from it. Cleaning must only be carried out by an appropriate adult.
 14. Children between 3 and 8 years should not turn on or off the device, unless this is installed or placed in a normal position and that children are under proper supervision or have received instructions regarding the use of the device as security and they have perfectly understood the potential dangers. Children between 3 and 8 years old should not connect, adjust or clean the appliance or perform any maintenance measure.
 15. **Warning:** Do not use this heater near baths, showers or swimming pools. It should not be possible to access the device's controls from the bath, shower or any other surface that is in contact with water. (Its use in zones 0 or 1 in bathrooms is totally prohibited: seek advice from a qualified electrician).
 16. For greater safety, this appliance is provided with a device that interrupts its operation in the case of overheating.
 17. This radiator has been designed exclusively to be fixed to the wall. For further information on the fixing systems, consult the section "INSTALLATION AND WALL MOUNTING" of this manual.
 18. Do not use accessories that have not been recommended by the manufacturer, as they could entail a potential risk to the user, and damage the device. Use only original accessories.
 19. Keep all the packaging elements (plastic bags, cardboard and polyethylene) out of the reach of children, as they can cause potentially dangerous situations.
-

20. Use this device only for domestic / light commercial use and the tasks for which it has been designed. This device has not been designed for industrial use. **It must not be used outdoors, in greenhouses or for animal husbandry.** Keep it away from heat, direct sunlight, humidity and cutting tools. Do not under any circumstances immerse in water or use this device with wet hands. In the case of humidity or water in the device, immediately disconnect the power supply and do not touch the wet parts.
21. Do not attempt to service the device yourself. Contact a qualified technician.
22. To disconnect the transmitter from the mains pull the plug, never of the supply cord.
23. Respect the "SPECIFIC SAFETY INSTRUCTIONS FOR THIS APPLIANCE" listed below

SPECIFIC SAFETY INSTRUCTIONS FOR THIS DEVICE

- The appliance must remain in a vertical position.
 - Make sure the appliance is secured at all times. Please adhere to the installation distances indicated in this guide.
 - Do not hang any object in front or on top of the device.
 - Always ensure that the inlet and outlet air are not obstructed.
 - Always install the device so that it cannot enter into contact with any combustible material such as curtains or towels (take into account the gusts of wind).
 - To clean the device, consult the instructions in the "MAINTENANCE" section, because if water enters the air grilles it could seriously damage the device.
 - Do not insert any object through the grille or inside the device.
 - This radiator is designed to be connected by plug to the electric installation and fixed to the wall installation. Follow the instructions in "INSTALLATION".
 - **The guarantee will not apply if these instructions have not been observed.**
-
-

INSTALLATION

- During the first use and for a few minutes, could occur smells and noise due to the dilatation of some internal parts. This is normal, so you must provide adequate ventilation. The smells are momentary and quickly will dissipate.
- For greater efficiency, make sure to calculate the power or the number of elements of the apparatus according to the surface of the room. We recommend contacting your dealer performing this calculation.
- Fix the radiator to a firm wall and make sure it is well-levelled, in a room with no furniture and no objects avoiding around.
- Avoid installing the appliance in corners.
- We advise against installing the appliance under the windows, because it is favoring the heat loss.
- The radiator must be away, at a minimum distance of 15 cm from any combustible material, curtains, furniture, chairs, etc. (Fig. 1).
- Allow for a minimum distance of 1 m, from the front of the unit to any obstacles (furniture, walls, curtains, for example) that could hinder its operation.
- Also keep a minimum distance of 15 cm between the appliance and the side walls and any other obstacles (walls, for example) that may affect its function. Also keep a minimum distance of 35 cm on top the appliance free of obstacles and a minimum distance of 15 cm from the floor.
- **WARNING:** If this appliance is installed in a bathroom, it must be installed only within Zones 2 or Outside Zones (Zone 3), according BS 7671 Requirements for Electrical Installations, Section 701. The installation of this appliance within Zones 0 or 1 of a bathroom is totally prohibited. The figure 2 bellow is only for information purposes, we suggest you contact a professional electrician.

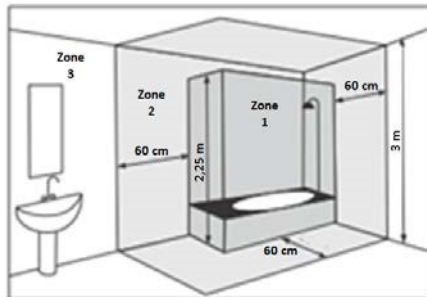
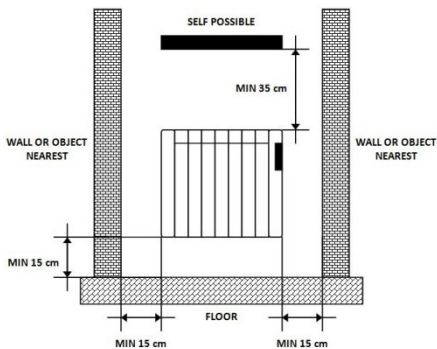

- Minimum Distances -

Zone 1: Appliances supplied to Safety Extra Low Voltage (SELV).
Zone 2: Electrical Appliances Class II – IP X4
Zone 3: Electrical Appliances protected by RCD 30mA

Fig.1

Fig.2

WALL-MOUNTING

The radiator is equipped with a support, two lag screws and their corresponding plugs.

- 1^o Fix the bracket to the wall, respecting the height indicated. Fig 1 - 2^o Hang and centre the appliance on the bracket.
- 3^o Finally, fix with the screw at the junction of the wall bracket and the radiator.

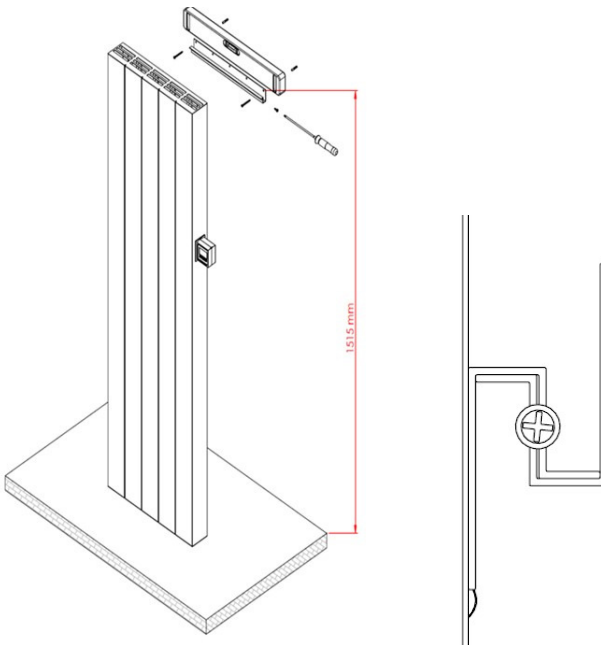

ELECTRIC SUPPLY CONNECTION

This appliance is equipped with a supply cord **H05V2V2-F 3x1.0mm²**.









Check the condition of your electrical installation and connection cables.

Contact a licensed electrician for assistance.

PROGRAMMABLE DIGITAL THERMOSTAT





This radiator is equipped with various functions and operating modes that the user can select using the “MODE”  button.



The operating modes are: Pilot Wire, Comfort, Economy, Anti-Frost, Holidays, Timer, Turbo, Eco and Off (Stand-by). These are their related icons:

								
PILOT WIRE	COMFORT	ECONOMY	ANTI FROST	HOLIDAYS	TIMER	TURBO	ECONOMY SET AT 17°C	OFF /STAND BY









Pilot Wire Mode: The thermostat’s functions are controlled through a signal received from the “Pilot Wire” unit. **FOR USE IN FRANCE ONLY**



-  **Comfort Mode:** The thermostat keeps the room temperature at the value established by the user.
-  **Economy Mode:** The thermostat keeps the room temperature below the configured Comfort value.
-  **Anti-Frost Mode:** The thermostat keeps the room temperature above 7 °C.
-  **Holiday Mode:** The radiator enters the “Anti-frost” mode for the period of time established by the user.

-  **Timer Mode:** The thermostat operates as per a daily/weekly programme defined by the user.
- **BOOST** **Turbo/boost Mode:** The thermostat continuously feeds the resistance during the period that is adjustable by the user, the maximum is 2 hours. After the period of time, the device returns to the previous operating mode. For safety reasons, the room temperature is automatically controlled in order not to exceed 32 ° C.
- **EGO** **Economy Mode set at 17°C:** The device keeps the room temperature stable at 17 ° C
-  **Off (Stand-by) Mode:** In this mode the electric resistance is not being fed and the light at the back of the screen goes off. However, the thermostat is operating.

Other thermostat functions are:

	ASC				KWh	
OPEN WINDOW DETECTION	ASC	CHILD PROTECTION	POWER LEVEL INDICATOR	BLOCKED	CONSUMPTION METER	CONSUMPTION INDICATOR

- **Other functions and icons**
-  **Open window detection:** This function allows us to detect that a window is open due to a sudden drop in room temperature. In this case, the device stops feeding the resistance for a maximum of 30 minutes or until an abrupt increase in room temperature shows that the window has been closed.
- **ASC** **Adaptive temperature control (ASC):** This function anticipates radiator's operating start time regarding the programmed value (only for Timer mode).
-  **Safety for children:** This function reduces the radiator's surface temperature.

-  **Power level indicator:** Instantaneous consumption visualisation.
-  **Blocked:** Function to prevent accidental or improper use.
- **kWh** **Consumption meter:** This function lets us know the consumption data for different periods, in kWh.
-  **Consumption indicator:** To see if the device is consuming at the moment or not.

SCREEN

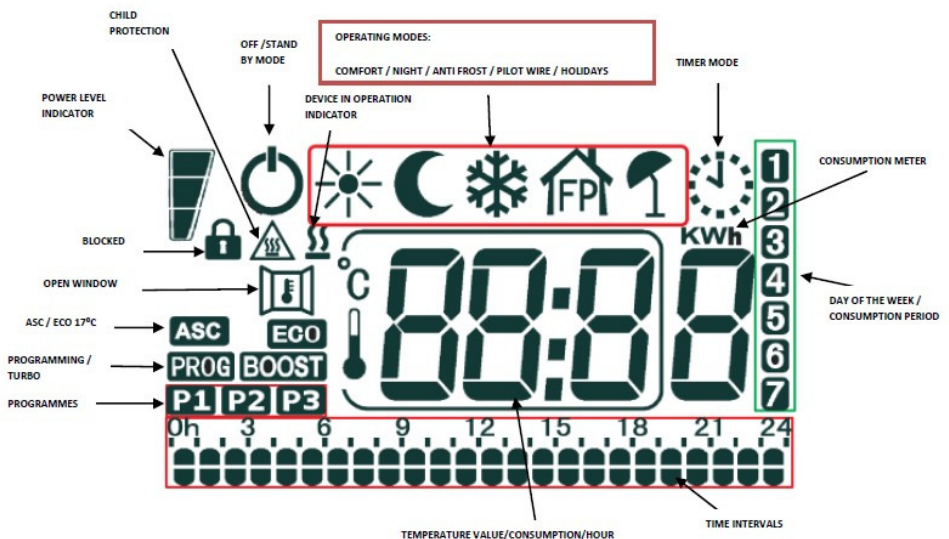

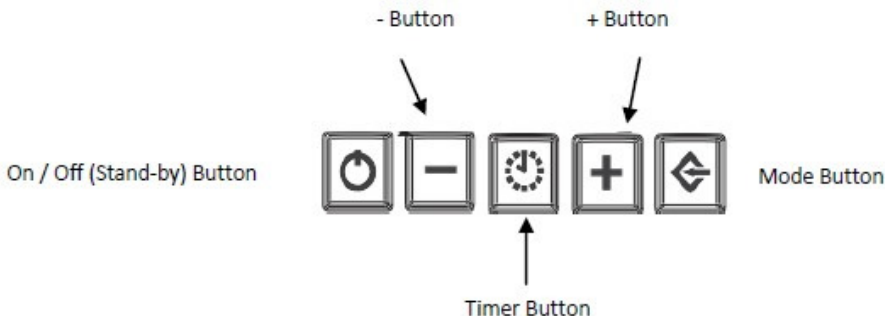



1. ON / OFF (STAND-BY)

Press the  On/Off (Stand-by) button to turn the radiator on or to set the off/stand-by mode.



If the off/stand-by mode is activated, the corresponding  icon will appear on the screen and there will be two 0.5 second bleeps and the time will be shown.

When the device is turned on, there will be a one second bleep and the  icon will disappear.

2. MAIN FUNCTIONS





 **PILOT WIRE Mode:** (FOR USE IN FRANCE ONLY). In this mode, the radiator is controlled by a unit with this type of system.

In order to activate it, follow these steps:

1. Press the "Mode"  button several times until the  icon appears on the screen. From this moment onwards, the radiator's operating mode is the one determined by the unit.





 **COMFORT Mode:** This is the radiator's standard operating mode to maintain the user's desired temperature.



In order to activate it, follow these steps:



1. Press the "Mode"  button several times until the  icon appears on the screen.
2. Select the desired temperature using the  and  buttons. The minimum value that can be programmed is equal to the value of the temperature programmed in economy mode plus 0.5°C. The maximum value is 32°C.

 **ECONOMY Mode:** Selecting this mode, the radiator maintains the room temperature at the one selected for it.





In order to activate it, follow these steps:

1. Press the "Mode"  button several times until the  icon appears on the screen.
2. Select the desired temperature using the  and  buttons. The maximum value that can be programmed is equal to the value of the COMFORT temperature less 0.5°C. The minimum value is 7°C.

NOTE: The COMFORT and ECONOMY temperatures are the programme's determining values. It is not possible to select a temperature value for the ECONOMY mode superior to the COMFORT temperature, as the electronic thermostat does not allow it. When operating, it is possible to change the temperature easily by pressing the  and  buttons.







 **ANTI-FROST MODE:** Selecting this mode, the room temperature is set at 7°C. In order to activate it, press the "Mode"  button several times until the  icon appears on the screen.

 **HOLIDAY MODE:** Selecting this mode, the radiator enters the ANTI-FROST mode for the period of time established by the user. In order to activate it, follow these steps:

1. Press the "Mode"  button several times until the  icon appears on the screen.
2. Using the  and  buttons it is possible to select the holiday period duration, from 12 hours to 40 days, with an increase of one hour 12 to 24 and with an increase of one day from 24 hours.



TIMER MODE: In this mode, the room temperature is maintained at the COMFORT or ECONOMY temperature depending on the programmes established for the different time intervals during the day (P1, P2 or P3). In order to activate it, follow these steps:

1. Press the “Mode”  button several times until the  icon appears on the screen.
2. Press the TIMER  button to select one of the pre-established factory programmes (P1  and P2 ) or the programme that is configurable by the user (P3 ,).

For configurable programming P3, please look at section “4. PROGRAMMING” in this manual.

The pre-established P1 and P2 programmes are:

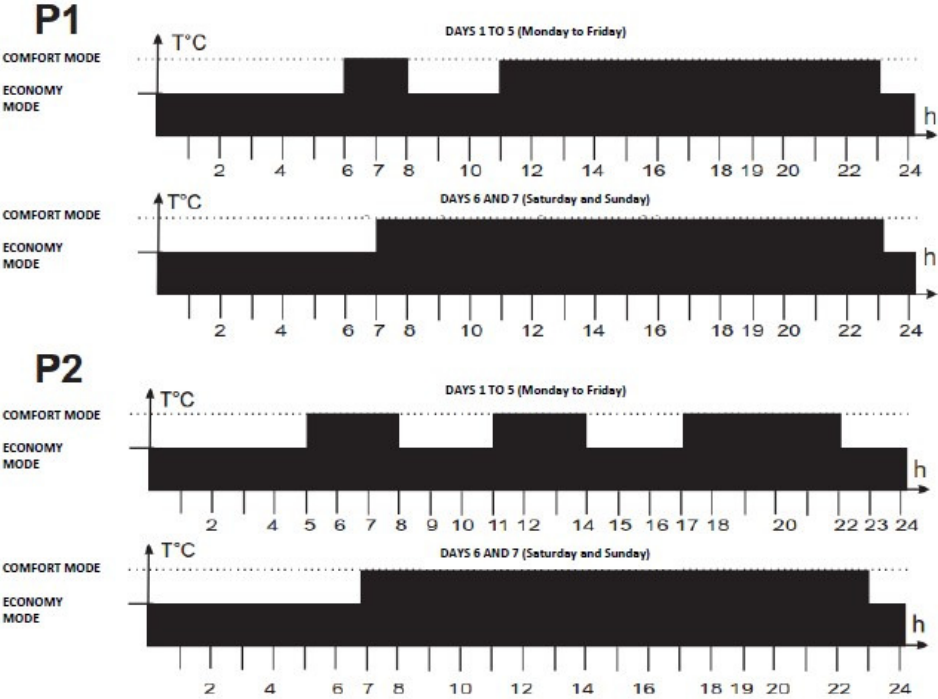



BOOST

TURBO/BOOST MODE: This mode can be used when we need to heat the room quickly.

In order to activate it, follow these steps:





1. Press the "Mode"  button several times until the **BOOST** icon appears on the screen.
2. Pressing the  and  buttons it is possible to select the TURBO/BOOST period duration from 5 to 120 minutes. When this function is activated, the radiator operates at its maximum power, ensuring that the room temperature does not exceed 32°C. When the programmed time (indicated by the countdown on the screen) finishes, the radiator returns to the previously established mode.

EGO **ECONOMY MODE 17°C:** Activating this mode the radiator operates at a preestablished, unchangeable temperature of 17°C. This function allows for lower consumption when, for example, the room or the house is empty for an indefinite period of time.

To select this mode, press the "Mode"  button several times until the **EGO** icon appears on the screen.

3. OTHER FUNCTIONS AND ICONS

 **OPEN WINDOW DETECTION:** The radiator is able to detect if a window has been opened through a sudden drop in temperature (5°C in a maximum of 30 minutes). If this happens, the device disconnects for 30 minutes so as to, later on, operate again at the previously established mode if it detects continuous increases in temperature of one degree (because, for example, the window has been closed). If this is not the case, the device will remain disconnected for an additional period of 30 minutes.

When the open window detection is activated, the corresponding symbol  will appear intermittently on the screen (except in off/stand-by mode). When it is deactivated, the symbol disappears.

In order to activate this function, please look at section **"4. PROGRAMMING"**.

 **CHILD PROTECTION:** When this function is activated, the temperature on the front part of the radiator is lowered so that it is safe when children are present. Moreover, this function means that the same radiator can be used in rooms smaller than the one it is installed in without significant changes in room temperature.

When this function is activated, the power level that the radiator operates at is the one established by the user (40% - 50% - 60%).

In order to activate this function, please look at section “**4. PROGRAMMING**”.

ASC **ASC (ADAPTIVE TEMPERATURE CONTROL):** When this function is activated, the device connects before the time established in the programming (maximum 2 hours beforehand) to ensure that the room is at the programmed temperature at the established time.

When this function is activated, the corresponding **ASC** icon appears on the screen (except in off/stand-by mode).



In order to activate this function, please look at section “**4. PROGRAMMING**”.

POWER LEVEL INDICATOR: This appears on the left-hand side of the screen and it depends on the programmed temperature level. The higher the programmed temperature is, the greater the number of bars shown on the icon. This is instantaneous consumption visualization as, the higher the programmed temperature is, the higher the energy consumption is.

LOCK **BLOCK FUNCTION:** It is possible to block the radiator to prevent children from using it improperly or, for example, in a public space.

In order to block/unblock the buttons, press the “Mode”  button and keep in pressed down for 3 seconds, until the icon appears (blocked) or disappears (unblocked).



kWh **CONSUMPTION METER FUNCTION:** This function allows us to read the radiator’s consumption expressed in kWh. In order to do so, the power of the emitter must be previously adjusted, following these steps:

1. Unplug the device from the electricity supply.
2. Simultaneously press buttons  and .
3. Without releasing the buttons, plug the device into the electricity supply for at least 5 seconds until you can see the power adjustment function, as shown in this image:





buttons to select your radiator's power in Watts.

button.

4. Use the  and 
5. Confirm the selection with the 

This operation only needs to be done the first time and then it will stay saved; it is not necessary to repeat it every time you wish to consult consumption.

Now you can read the consumption for various periods of time in the following way:

1. Turn the radiator to off/stand-by mode.
2. Press the  button for more than 3 seconds until the consumption data is shown on the screen.
3. Using the  and  buttons, we can scroll the consumption menu.
4. The icons will appear on the right-hand side of the screen. Each one shows the consumed kWh during the corresponding period of time, as shown here:

 = current day

 = previous day



 = current week



 = previous week



 = current month

 = previous month

 = current year

 +  = previous year

 +  = total

 +  = radiator power indicator

























CONSUMPTION INDICATOR: When the room temperature falls below the configured temperature, the radiator's thermostat feeds the resistance and the "SS" symbol lights upon the screen, with which it is consuming energy. As soon as the room temperature reaches the selected temperature, the thermostat stops feeding the resistance and the "SS" icon disappears from the screen, as it is no longer consuming energy.

IMPORTANT NOTE: If "ALL" appears on the screen then the temperature sensor is broken or damaged and the radiator does not work. Please contact our technical service.





4. PROGRAMMING

DAY AND TIME PROGRAMMING







1. Turn the radiator to off/stand-by mode. The  icon will be shown.
2. Press the  button for more than 3 seconds until the functions can be seen. Using the  button you can scroll through the following options: "ted" (hour and date), "prog" (programming) and "ofst" (calibration of the temperature sensor).
3. Select the "ted" option and confirm with the  button.
4. Enter the current year (15-99) using the  and  buttons. Press the  button to confirm the selection.
5. Enter the current month (1-12) using the  and  buttons. Press the  button to confirm the selection.
6. Enter the current date (1-31) using the  and  buttons. Press the  button to confirm the selection.
7. Enter the day of the week (1=Monday, 2=Tuesday, 3=Wednesday, 4=Thursday, 5=Friday, 6=Saturday, 7=Sunday) using the  and  buttons. Press the  button to confirm the selection.
8. The current hour should then appear on the screen with the digits intermittently lighting up. The hour can be modified using the  and  buttons. Press the  button to confirm the selection.
9. The digits indicating the minutes light up intermittently on the screen. The minutes can be set using the  and  buttons. Press the  button to confirm the selection.

CONFIGURATION OF THE P3 PROGRAMME

You can configure your own operating programme (P3) for each day of the week by following these steps:

1. Turn the radiator to off/stand-by mode. The  will be shown.
2. Press the  button for more than 3 seconds. Using the  button you can see the following options: “**ted**”(hour and date), “**prog**”(programming) and “**ofst**”(calibration of the temperature sensor).
3. Select the “**Prog**” option and confirm with the  button.
4. The programme will start on the first day of the week (1=Monday), and at 0 hours. The day is divided into intervals of one hour each.









5. Pressing the  button we select the COMFORT mode in this time interval (the whole interval will be highlighted). Pressing the  button we select the ECONOMY mode for this time interval (half an interval will be highlighted). And so on until completing the 24 hours of day 1=Monday. Confirm the programming with the  button.
6. Automatically, the programming goes on to day 2=Tuesday, maintaining the programming established for Monday. If you wish to maintain it, press directly on the  button to confirm and go to the next day. Otherwise, you can change using the  and  buttons to programme as you wish.
7. Follow the same steps for each day of the week until reaching day 7=Sunday.

CALIBRATION OF THE TEMPERATURE SENSOR







If the radiator is not installed in the optimum location to suitably detect the room temperature (for example: it is installed on a cold wall or there are draughts...) the measured room temperature may be different from the real temperature. In order to achieve maximum efficiency, it is recommendable to eliminate this temperature difference.

To do so, follow these steps:

1. Turn the radiator to off/stand-by mode. The  icon will be shown.
2. Press the  button for more than 3 seconds. Using the  button we can see the following options: “**ted**” (hour and date), “**prog**” (programming) and “**ofst**” (calibration of the temperature sensor).
3. Select the “**ofst**” option and confirm with the  button.
4. With the  and  , buttons establish the temperature difference between the room temperature (measured with a thermometer) and the temperature detected by the radiator. This difference can be adjusted between -5°C and +5°C.
5. Press the  button to confirm the selection.

ACTIVATING OTHER FUNCTIONS

OPEN WINDOW DETECTION





1. Turn the radiator to off/stand-by mode. The  will be shown.
2. Press  the  button for more than three seconds, until you can see the  icon.
3. Press the  button again to activate or deactivate the open window detection function (ON=activate; OFF=deactivate).
4. Press the  button to confirm the selection and go to the next function:

ASC (ADAPTIVE TEMPERATURE CONTROL)

1. Press the  button to activate or deactivate the ASC function (ON=activate; OFF=deactivate).
-

2. Press the  button to confirm and go to the next function:

CHILD PROTECTION

1. Press the  button to activate or deactivate the child protection function (ON=activate; OFF=deactivate).
2. Press the  button to confirm the selection. If you have selected to deactivate it (OFF), the radiator will automatically go to off/stand-by mode. If, on the other hand, you have selected to activate it (ON), you can programme the percentage of power desired between the following values: 40% / 50% / 60%. Using the  button you select one or another.
3. Confirm the desired percentage with the  button. In this way, all the changes made to the anterior functions will be saved and the radiator will return to its off/stand-by state .

THERMAL SAFETY

In the case of overheating, a safety device automatically cuts the radiators operation. After cooling the radiator will automatically reset.

MAINTENANCE

Your radiator requires no regular maintenance, however, to ensure its good operation:

Always disconnect the device from the mains before performing any cleaning or maintenance operation.

Let it cool down before cleaning.

To avoid any risk of electrical shock, clean the unit with a soft, damp cloth to wipe the outside of the radiator and remove dust and dirt cloth.

Do not use detergent, solvent, abrasive products or any other chemical product to clean the radiator.

NEVER immerse the device in water or any other liquids.

You can use a vacuum or flexible brush to clean the air grilles. This maintenance must be carried out regularly to ensure optimum performance. Ensure the radiator is totally dry before turning it back on.

EU Declaration of Conformity



<i>Product:</i>	Ceramic Heater
<i>Models:</i>	AMBIENTE V
<i>Types:</i>	AMBIENTE V 1000. AMBIENTE V 1500. AMBIENTE V 2000.
<i>Batch & Serial No.:</i>	Mx- YYDDD-XXX ⁽¹⁾
(1) Explanation of code "Lot & Serial No.": Lot = Mx - YYDDD; where: Mx = <i>Production Line No.</i>; YY = <i>year</i> (15,16,17...99) and DDD = <i>jour corrélatif</i> (001,...., 365).	
Serial No. = XXX (001,...., 999) .	

We:

Hereby declare, that the following equipment complies with all the essential requirements for health and safety of European Directives.

**2014/30/UE EMC DIRECTIVE 2014/35/UE LV DIRECTIVE
2011/65/UE RoHS DIRECTIVE 2009/125/EC (ErP Directive)**

With reference to the application of the following standards:

2014/30/UE EMC DIRECTIVE	EN 55014-1:2006 +A1:2009 +A2:2011 EN 61000-3-2:2014 EN 61000-3-3:2013 EN 55014-2:1997 +AC: 1997 +A1:2001 +A2:2008 EN 61000-4-2:2009 EN 61000-4-3:2006 +A1:2008 +A2:2010 EN 61000-4-4:2012 EN 61000-4-5:2006 EN 61000-4-6:2013 EN 61000-4-11:2004
2014/35/UE LV DIRECTIVE	EN 60335-2-30:2009 + CORR:2010 +A11:2012 EN 60335-1:2012 +AC:2014 +A11:2014 EN 62233:2008 +CORR:2008
2011/65/UE RoHS DIRECTIVE	EN 62321-1:2013
2009/125/EC (ErP Directive)	UE 2015/1188

Model: AMBIENTE V					
Item	Symbol	Value	Unit	Item	Unit
Heat output 2000				Type of heat output/room temperature control (select one)	
Nominal heat output	P_{nom}	2	kW	single stage heat output and no room temperature control	NO
Maximum continuous heat output	$P_{max,c}$	2	kW	Two or more manual stages, no room temperature control	NO
Auxiliary electricity consumption				with mechanic thermostat room temperature control	NO
At nominal heat output	e_{lmax}	2	kW	with electronic room temperature control	NO
In standby mode	e_{lsb}	0.0005	kW	electronic room temperature control plus day timer	NO
				electronic room temperature control plus week timer	YES

Heat output 1500				Other control options (multiple selections possible)	
Nominal heat output	P_{nom}	1.5	kW	room temperature control, with presence detection	NO
Maximum continuous heat output	$P_{max,c}$	1.5	kW	room temperature control, with open window detection	YES
Auxiliary electricity consumption				with distance control option	NO
At nominal heat output	e_{lmax}	1.5	kW	with adaptive start control	YES
In standby mode	e_{lsb}	0.0005	kW	with working time limitation	YES
Heat output 1000				with black bulb sensor	NO
Nominal heat output	P_{nom}	1	kW		
Maximum continuous heat output	$P_{max,c}$	1	kW		
Auxiliary electricity consumption					
At nominal heat output	e_{lmax}	1	kW		
In standby mode	e_{lsb}	0.0005	kW		

Requirements regarding ecodesign for local heating:

$$\eta_s = \eta_{s,on} - 10\% + F(1) + F(2) + F(3) - F(4) - F(5)$$

$$\eta = 40 - 10\% + 0 + 7 + 2 - 0 - 0 = \mathbf{39\%}$$

RECYCLING (Disposal of the product at the end of its useful life)



According to European Directive **2012/19/UE**, on waste electrical and electronic equipment (WEEE), old electrical household appliances cannot be disposed of in the usual municipal containers; they have to be collected separately to optimise the recycling of the components and materials that comprise it, and reduce the impact on human health and the environment. The crossed-out wheeled bin is marked on all Electrical and Electronic products, to remind the consumer of their obligation dispose of them separately.

The consumer must contact the local authority or the vendor to learn about the correct disposal of his/her old electrical household appliance.

In the case of scrapping the radiator, containing oil; should the provisions concerning the disposal of oil followed.

