

# HEXO MINI

07-Apr.-2017

## 1.0

PAR16 max. 15W | GU10 | 100-240VAC | 50-60Hz

CE IP20 0.9m

	gold	300420G0
	bronze	300420Q0
	copper	300420P0
	black texture	300420B0

OPTIONAL  
for PAR16 lamps see our catalogue

## 2.0

2xPAR16 max. 15W | GU10 | 100-240VAC | 50-60Hz

CE IP20 0.9m

	gold	301420G0
	bronze	301420Q0
	copper	301420P0
	black texture	301420B0

OPTIONAL  
for PAR16 lamps see our catalogue

HEXO MINI 1.0

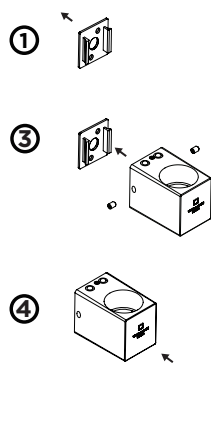

HEXO MINI 2.0

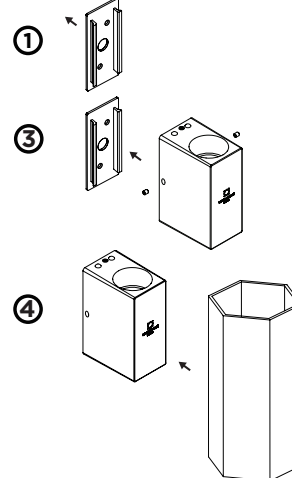

## DIMENSIONS

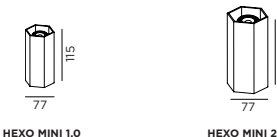

## MOUNTING INSTRUCTION

- 1 Mount the base plate on the wall

## POWER CONNECTION

- 2 Connect the power supply.

Interior: STANDARD version

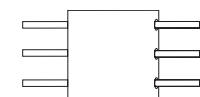

- 3 Mount inset on the back plate with side screws

- 4 Click cover over the inset

\* For optional locking, unscrew the grub screw app. 3mm. The cover is now stable.

- 5 Mount the bulb.

## FOR OPTIONAL LOCKING:

\* Lock the cover by unscrewing the grub screw app. 3mm. Then the cover is stable.

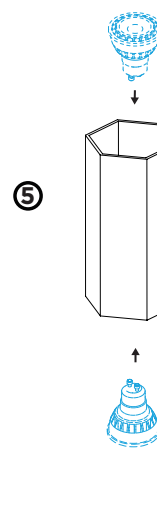
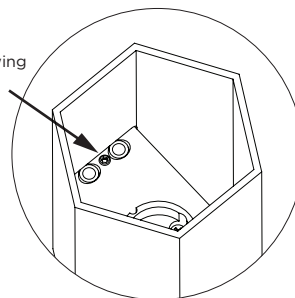

HEXO MINI 1.0

HEXO MINI 2.0

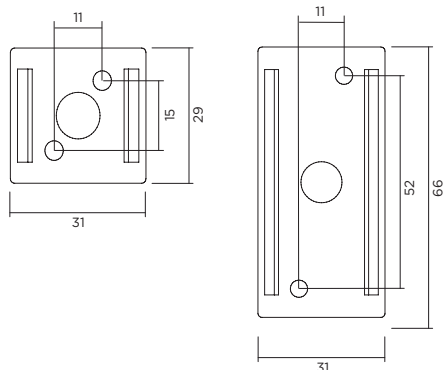

WEVER & DUCRÉ  
LIGHTING

[www.weverducre.com](http://www.weverducre.com)

Wever & Ducre bvba Kwadestraat 153 bus 2.1 8800 Roeselare

INSTALLATION  
INSTRUCTIONS