

RINI

31-May-2016

1.0 LED	
LED	7/10W 350-500mA COB 3-step excl. power supply
CE	IP44 (0.3m) P
white texture	154161W_
black texture	154161B_
LIGHT COLOUR	
2700K >90CRI 420-590lm 18Vf	3
3000K >90CRI 470-640lm 18Vf	5
1800-2850K >90CRI 320-440lm 18Vf	9
ALWAYS USE for power supplies see our catalogue	

1.0 PAR16	
Max. 35W GU10 220-240VAC	
CE	IP44 (0.9m) P
white texture	154120W0
black texture	154120B0
OPTIONAL for PAR16 lamps see our catalogue	

1.0 MR16	
QR-CBC51 Max. 35W GU5.3 12V excl. transformer	
CE	IP44 (0.9m) P
white texture	154110W0
black texture	154110B0
ALWAYS USE for transformers see our catalogue	

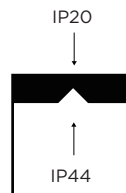
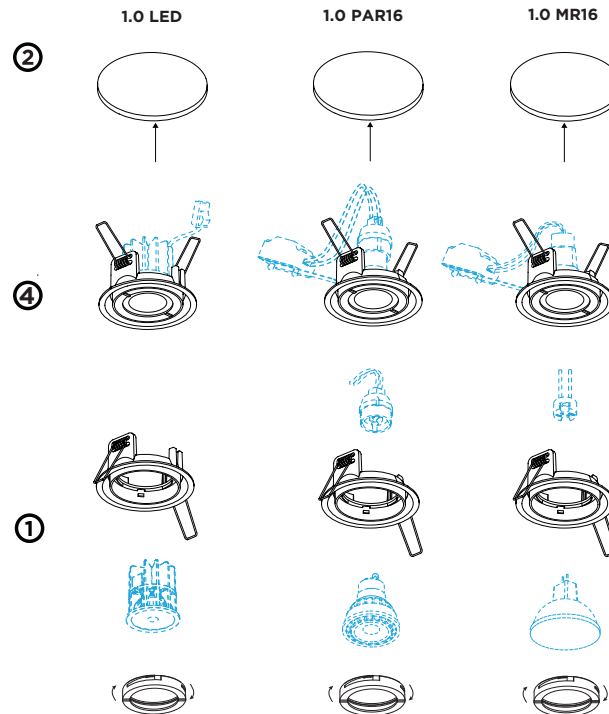

IP RATING when installed.
(Fixture is IP20 for the recessed part & IP44 at the visible side)



FOR HALOGEN LAMPS:

1. The mounting height for the luminaire should be more than 2.5m.
2. Luminaires not suitable for covering with thermally insulating material.
3. Luminaires not suitable for direct mounting on normally flammable surfaces (suitable only for mounting on noncombustiblesurfaces)

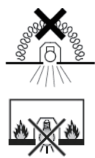

DIMENSIONS

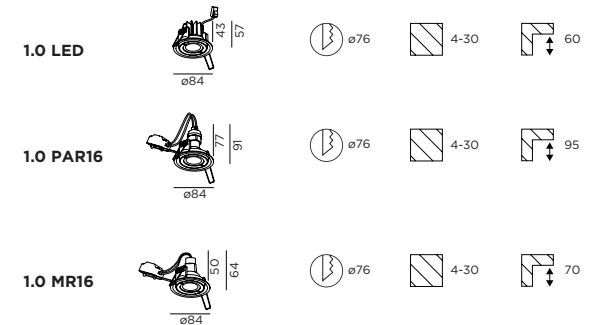

MOUNTING INSTRUCTION

- 1 Put the illuminant in the assembled cover.
- 2 Make a hole in the ceiling according to the prescribed dimensions.

3 POWER CONNECTION

SERIAL CONNECTION - for LED

Always use POWER SUPPLY
according to the specifications of the LED-module

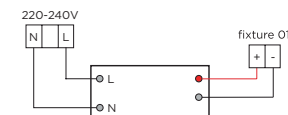

PARALLEL CONNECTION - for PAR16

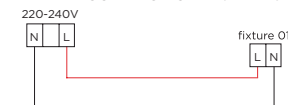

- 4 Turn the springs and insert the fixture in the ceiling hole



WEVER & DUCRÉ
LIGHTING

www.weverducre.com

Wever & Ducre bvba Kwadestraat 153 bus 2.1 8800 Roeselare

**INSTALLATION
INSTRUCTIONS**

PAGE 1/2

RINI

31-May-2016

2.0 LED

LED 7/10W | 350-500mA | COB 3-step | excl. power supply

CE IP44 0,3m

white texture	154261W_
black texture	154261B_

LIGHT COLOUR

2700K >90CRI 420-590lm 18Vf	3
3000K >90CRI 470-640lm 18Vf	5
1800-2850K >90CRI 320-440lm 18Vf	9

ALWAYS USE

for power supplies see our catalogue

2.0 PAR16

Max. 35W | GU10 | 220-240VAC

CE IP44 0,9m

white texture	154220W0
black texture	154220B0

OPTIONAL

for PAR16 lamps see our catalogue

2.0 MR16

QR-CBC51 Max. 35W | GU5.3 | 12V | excl. transformer

CE IP44 0,9m

white texture	154210W0
black texture	154210B0

ALWAYS USE

for transformers see our catalogue

1.0 LED

1.0 PAR16

1.0 MR16

②

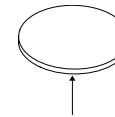
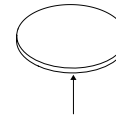
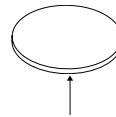

④

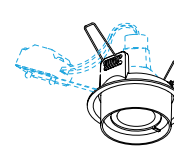

①



IP20

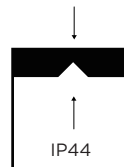

IP RATING when installed.
(Fixture is IP20 for the recessed part & IP44 at the visible side)

DIMENSIONS

2.0 LED

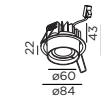

2.0 PAR16

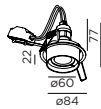

2.0 MR16

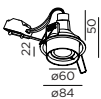

MOUNTING INSTRUCTION

- Put the illuminant in the assembled cover.
- Make a hole in the ceiling according to the prescribed dimensions.

③ POWER CONNECTION

SERIAL CONNECTION - for LED

Always use **POWER SUPPLY** according to the specifications of the LED-module

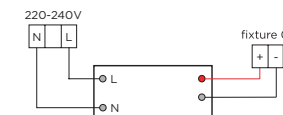

PARALLEL CONNECTION - for PAR16

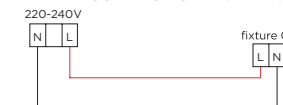

- Turn the springs and insert the fixture in the ceiling hole



FOR HALOGEN LAMPS:

- The mounting height for the luminaire should be more than 2.5m.
- Luminaires not suitable for covering with thermally insulating material.
- Luminaires not suitable for direct mounting on normally flammable surfaces (suitable only for mounting on noncombustiblesurfaces)



WEVER & DUCRÉ
LIGHTING

www.weverducre.com

Wever & Ducre bvba Kwadestraat 153 bus 2.1 8800 Roeselare

INSTALLATION
INSTRUCTIONS

PAGE 2/2