

# STAKE FOLD

24-Jan.-2018

## 1.0

LED 8W | 220-240VAC | 50-60Hz | PCB 3-step | incl. PS | phase-cut dim

CE IP54 10.3m 0-90°

3000K | >80CRI | 480lm

dark grey texture

727274D4

### OPTIONAL

groundspike

90013107

snoot

90019004

base plate

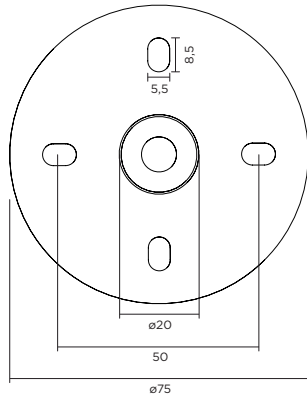

OPTIONAL, (ORDER SEPARATELY)  
snoot dimensions

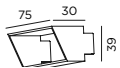

OPTIONAL, (ORDER SEPARATELY)  
groundspike dimensions

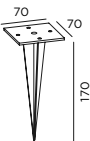

## DIMENSIONS

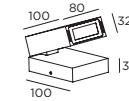

## MOUNTING INSTRUCTION

- 1 Fix the base plate on the ground by using screws. In case of use with an optional groundspike or on a base\*, remove the base plate with the side screws and fix directly on the groundspike.

## POWER CONNECTION

- 2 Connect the wires with the waterproof connections



- 3 Attach the STAKE to the base plate with the side screws
- 4 OPTIONAL : mount the SNOOT on the STAKE and lock it with two allen screws.

3

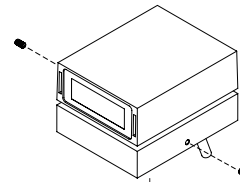

\* DO NOT COVER BASE (moss, bark, ...).  
Permanent moisture & possible chemical processes from eg. fertilization might lead in some combinations to a corrosive reaction.

1

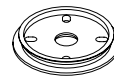

4 Mounting the SNOOT

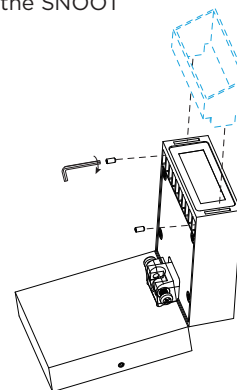

WEVER & DUCRÉ  
LIGHTING

[www.weverducre.com](http://www.weverducre.com)

Wever & Ducré bvba Kwadestraat 153 bus 2.1 8800 Roeselare

INSTALLATION  
INSTRUCTIONS