

TUBE

09-Jul.-2018

2.0 LED

LED 2x8W | 220-240VAC | 50-60Hz | COB 3-step | incl. PS | phase-cut dim

CE IP65 0,3m 38° 1 X

3000K | >90CRI | 2x480lm

white texture
dark grey texture
black texture

711264W5
711264D5
711264B5

2.0 PAR16

2xPAR16 max. 35W | GU10 | 100-240VAC | 50-60Hz

CE IP65 0,3m 38° 1 X

white texture
dark grey texture
black texture

711220W0
711220D0
711220B0

OPTIONAL

for PAR16 lamps see our catalogue

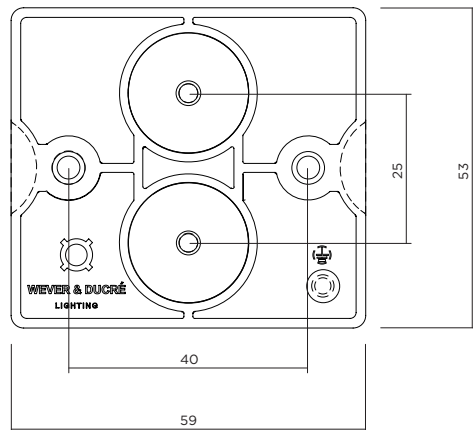

2.0 LED

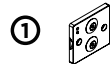

2.0 PAR16

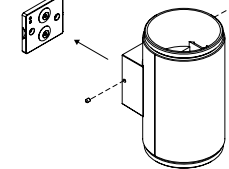
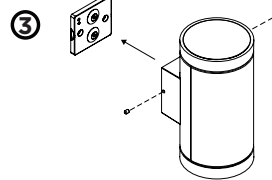

DIMENSIONS

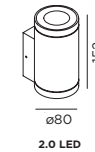

2.0 LED

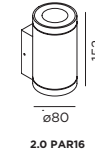

2.0 PAR16

MOUNTING INSTRUCTION

- 1 Remove the backplate and fixate it to the wall with screws.

2 POWER CONNECTION

Exterior: WATERPROOF Connection

IP-rated connections for wall fixtures: cable isolation for round cables \varnothing 4.5-7.5 mm, should be in the grommet. For cable use \varnothing 7.0-9.5 mm: replace the grommet with the other grommet in the bag. Refer to overview table.

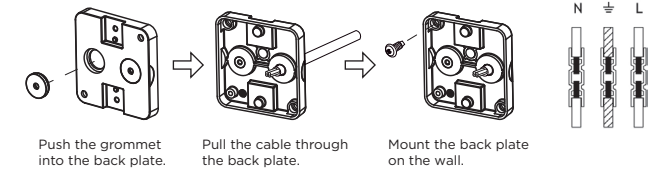

- 3 Fixate the fixture base to the back plate with side screws

- 4 For PAR16:
Remove the glass cover by turning it.
Insert the lamp.
Turn the glass cover back on the fixture.