

HANDLEIDING



Container ombouw Lara



BENODIGDHEDEN

Benodigde gereedschappen



Plank 135 x 16 mm

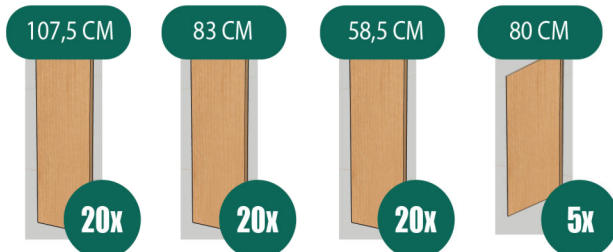

Balk 67 x 44 mm



Balk 44 x 44 mm

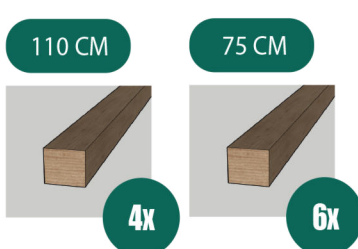

Zweeds zwart rabat



Instructies

Controleer alle onderdelen op deze onderdelen lijst vóór montage. Start niet met monteren bij ontbrekende onderdelen.

Neem de instructies van montage aandachtig door en volg deze stap voor stap voor een goede montage.

Voor optimale bescherming van de materialen adviseren wij het product op een vlakke en verharde ondergrond te plaatsen.

Losse onderdelen

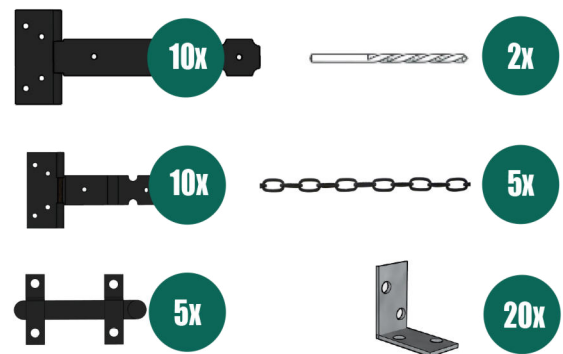

Schroeven & pluggen



Let op: Alles voorbereiden

MONTAGE STAPPENPLAN

Montage stap 1

- 2x Balk 67x44mm van 119 cm
- 1x Balk 44x44mm van 75 cm
- 4x Schroef 80 mm

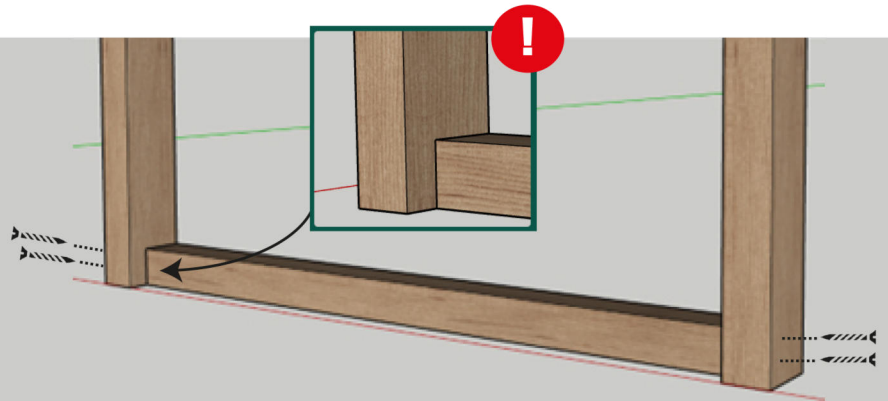

Montage stap 2

- 1x Balk 67x44mm van 75cm
- 4x Schroef 80mm

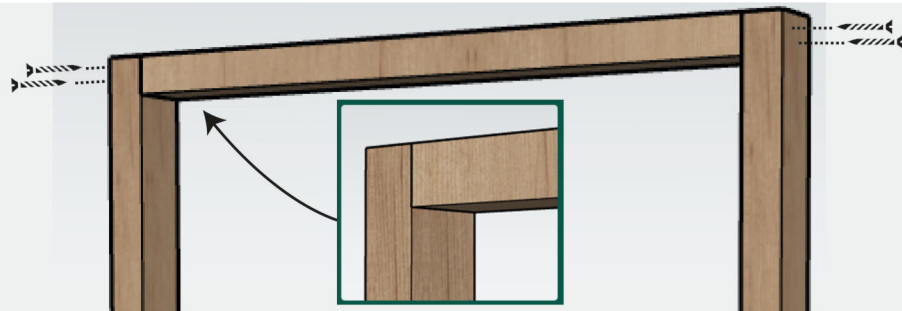

Montage stap 3

- 2x Balk 44x44mm van 110
- 6x Schroef 80mm

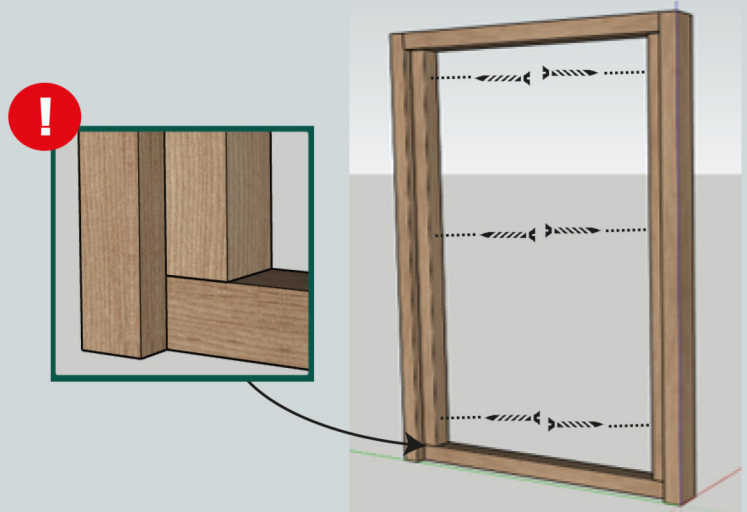

Montage stap 4

- 1x Zweeds rabat plank van 74,8 cm
- 4x Schroef 40mm

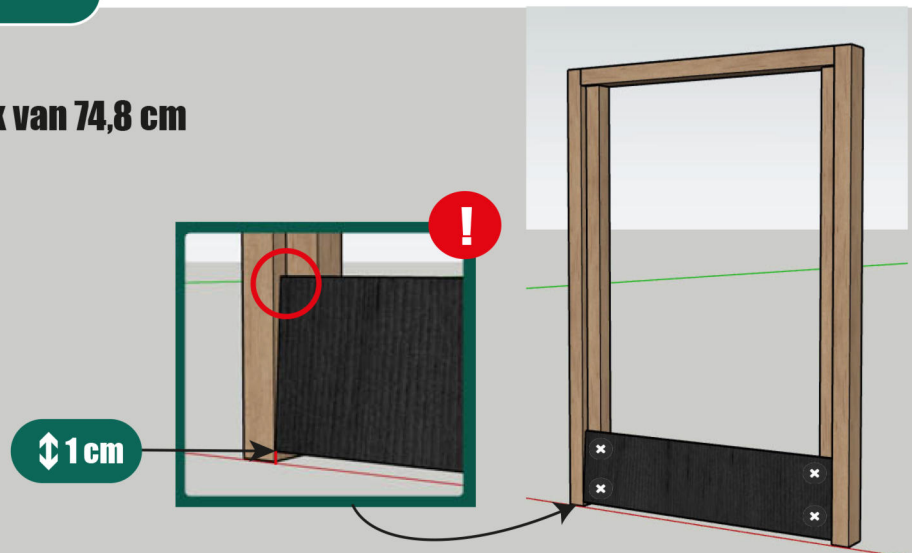

MONTAGE STAPPENPLAN

Montage stap 5

- 5x Zweeds rabat plank van 74,8 cm
- 20x Schroef 40mm



Verdeel de planken over de volledige hoogte

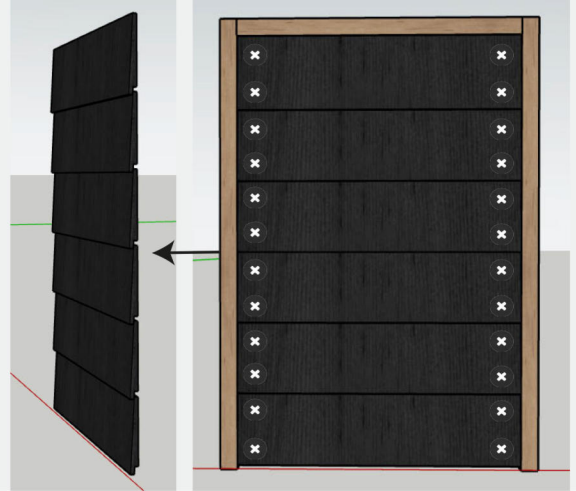

Montage stap 6

Herhaal stap 1 t/m 5 om tot 2 identieke panelen te komen

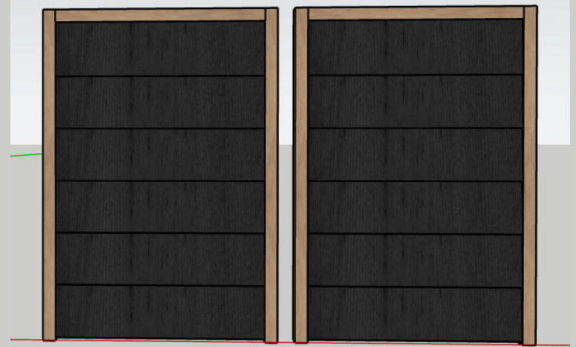

Montage stap 7

- 1x Balk 67x44 mm van 59,5 cm
- 1x Balk 67x44 mm van 119 cm
- 4x Schroef 120 mm

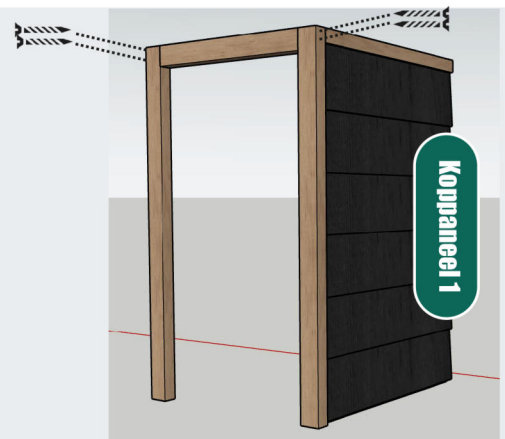

Montage stap 8

- 1x Balk 67x44 mm van 59,5 cm
- 1x Balk 67x44 mm van 119 cm
- 1x Stoelhoek
- 2x Schroef 120 mm
- 4x Schroef 30 mm

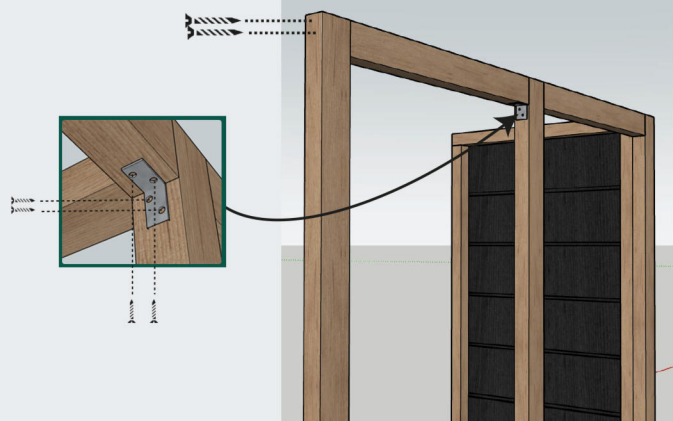

MONTAGE STAPPENPLAN

Montage stap 9

- 2x Balk 67x44mm van 59,5cm
- 2x Stoelhoek
- 4x Schroef 120mm
- 8x Schroef 30mm

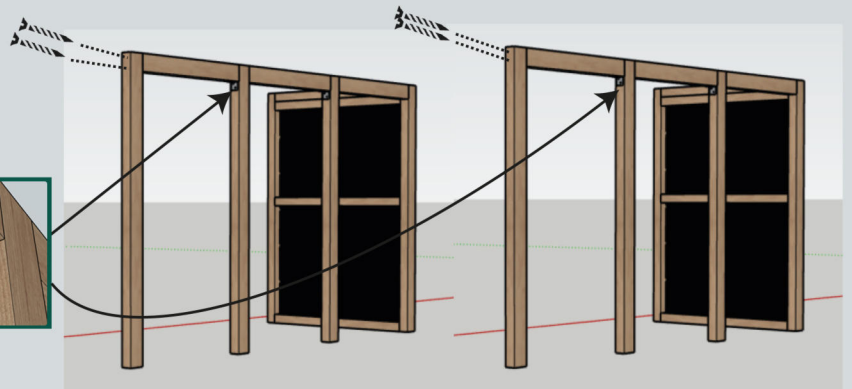
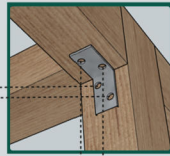

Montage stap 10

- 1x Balk 67x44mm van 59,5cm
- 1x Stoelhoek
- 2x Schroef 120mm
- 4x Schroef 30mm

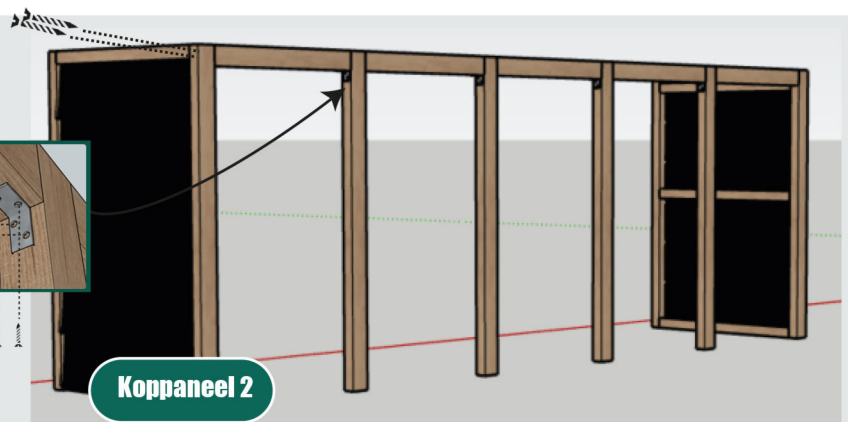
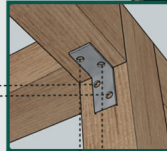

Montage stap 11

- 1x Balk 67x44mm van 59,5cm
- 1x Balk 67x44mm van 119cm
- 4x Schroef 120mm

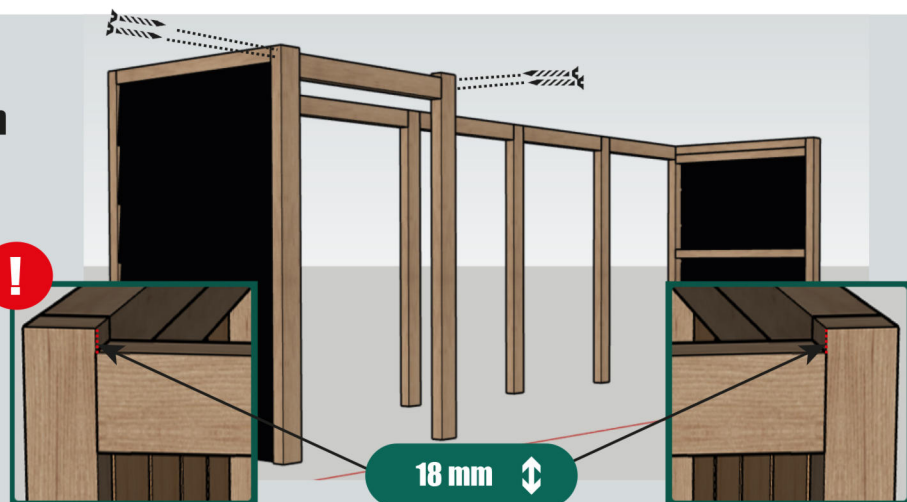

Montage stap 12

- 1x Balk 67x44mm van 59,5cm
- 1x Balk 67x44mm van 119cm
- 1x Stoelhoek
- 2x Schroef 120mm
- 4x Schroef 30mm

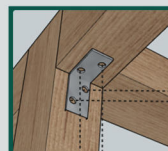

18 mm

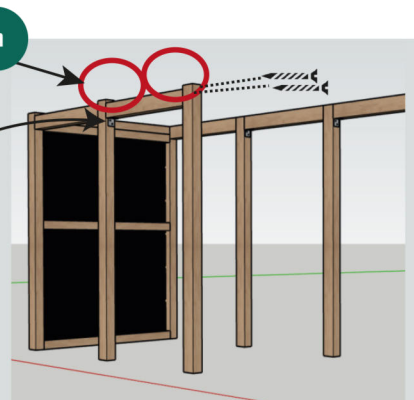

MONTAGE STAPPENPLAN

Montage stap 13

- 2x Balk 67x44mm van 59,5cm
- 2x Balk 67x44mm van 119cm
- 2x Stoelhoek
- 4x Schroef 120mm
- 8x Schroef 30mm

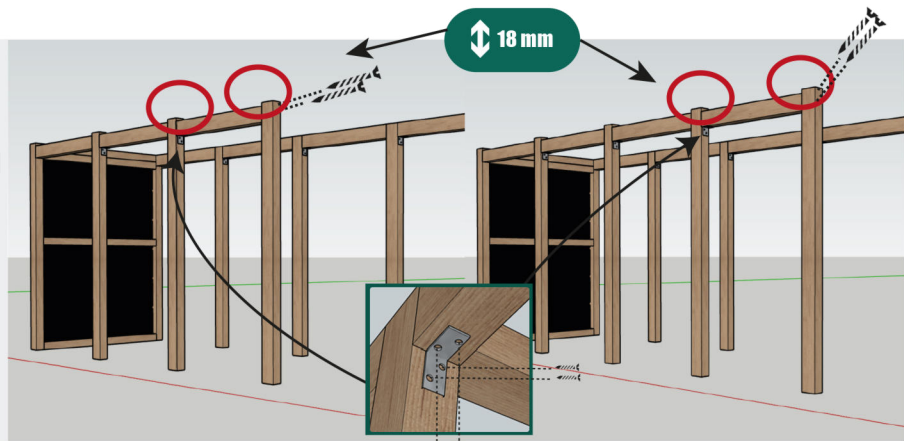

Montage stap 14

- 1x Balk 67x44mm van 59,5cm
- 1x Stoelhoek
- 2x Schroef 120mm
- 4x Schroef 30mm

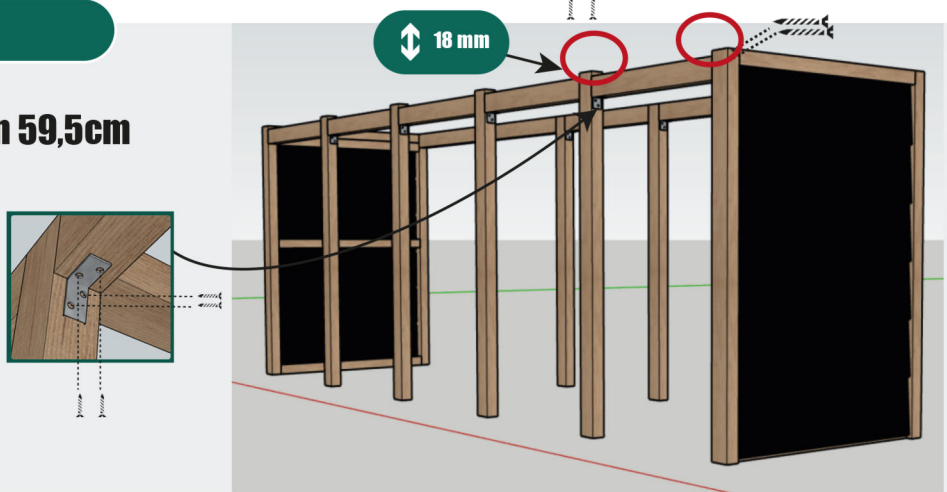

Montage stap 15

- 4x Balk 44x44mm van 75cm
- 16x Schroef 80mm

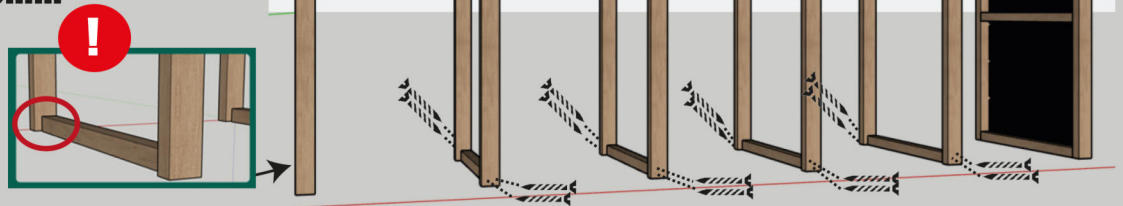

Montage stap 16

- 4x Balk 67x44mm van 75cm
- 16x Schroef 80mm

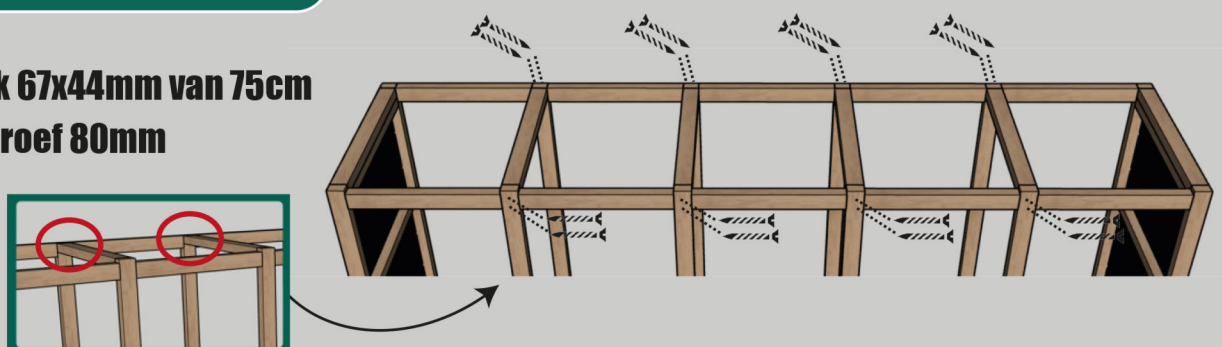

MONTAGE STAPPENPLAN

Montage stap 17

- 4x Balk 67x44mm - (schuin gezaagd)
- 8x Schroef 80mm

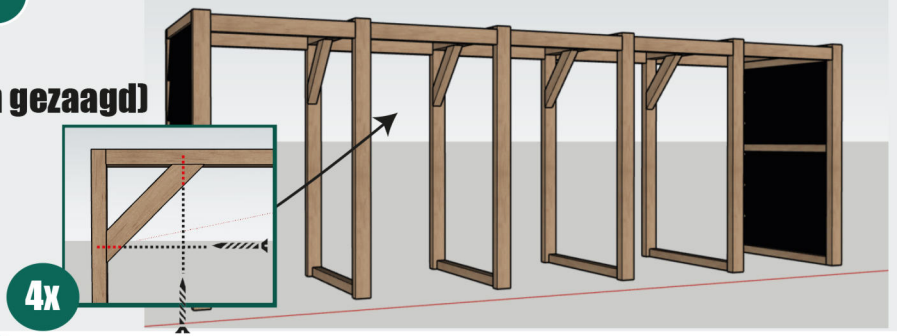

Montage stap 18

- 4x Balk 67x44mm - (schuin gezaagd)
- 8x Schroef 80mm

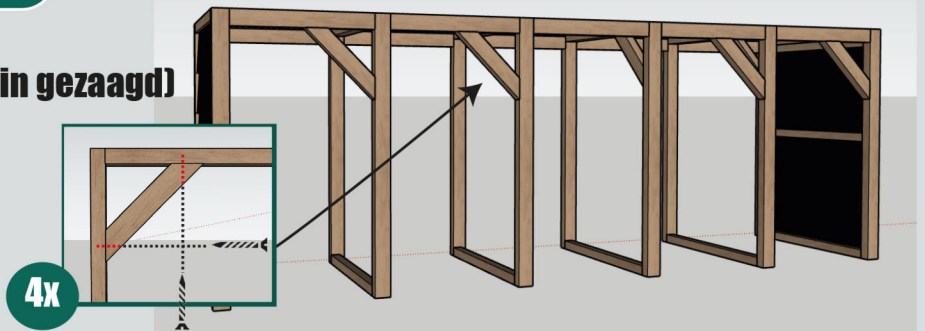

Montage stap 19

- 12x Stoeelhoek
- 24x Slagplug 40mm
- 24x Schroef 30mm

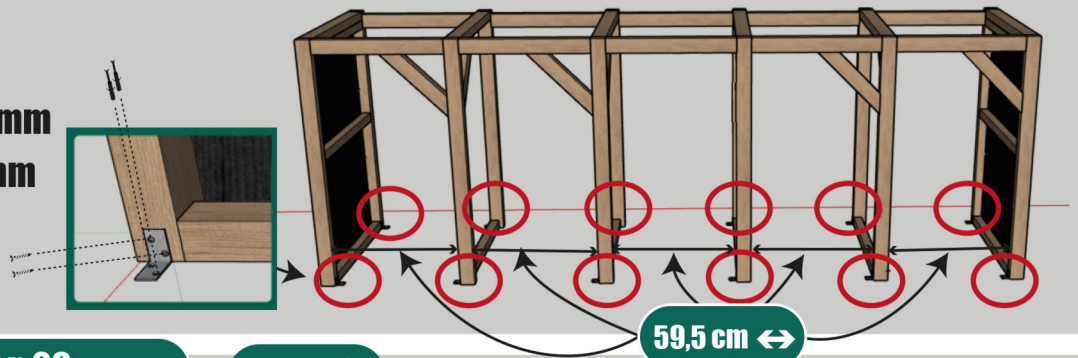

Montage stap 20

- 20x Plank 135x16mm van 83cm
- 10x Plank 135x16mm van 58,5cm
- 160x Schroef 30mm

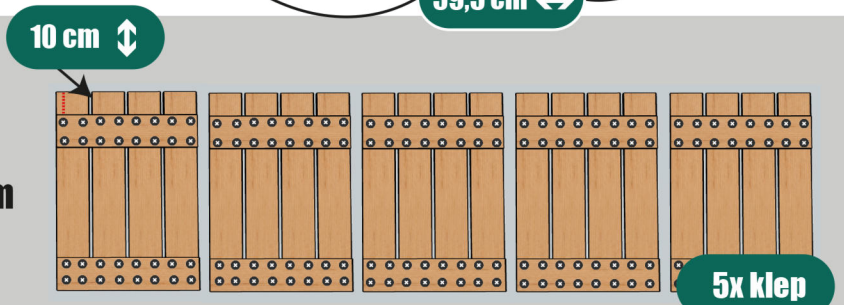

Montage stap 21

- 20x Plank 135x18mm van 107,5cm
- 10x Plank 135x18mm van 58,5cm
- 5x Plank 135x18mm van 80cm (schuin)
- 230x Schroef 30mm

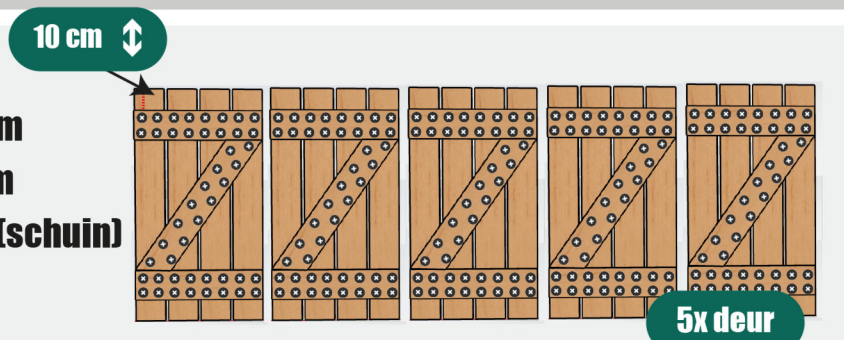

MONTAGE STAPPENPLAN

Montage stap 22

- 5x Klep
- 10x Scharnier geheng kort
- 60x Schroef 30mm

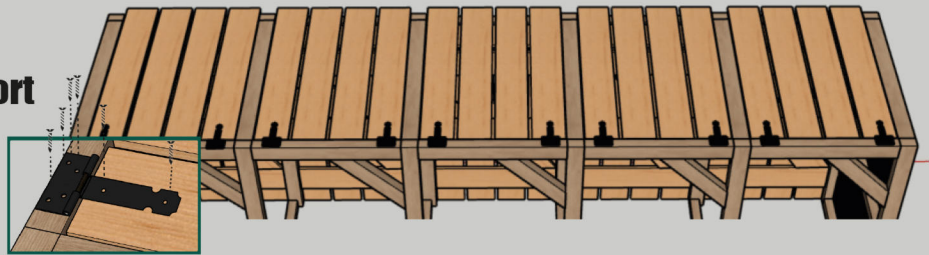

Montage stap 23

- 5x Deur
- 10x Scharnier geheng lang
- 5x Slot
- 90x Schroef 30mm

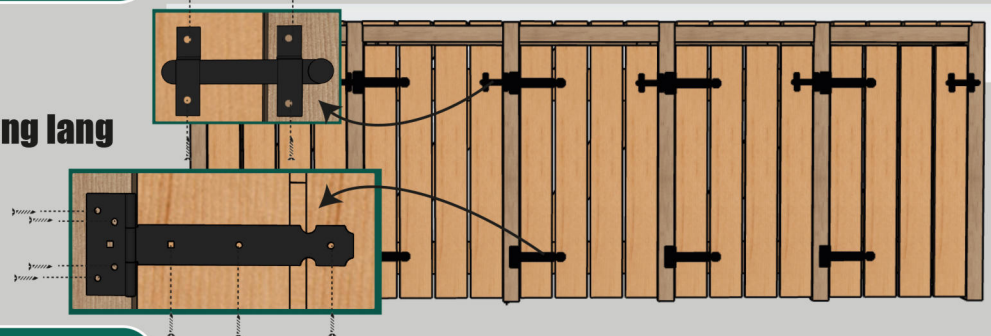

Montage stap 24

- 5x Ketting
- 5x Schroef 30mm

