

Leading - edge Technology

- ▶ Maximum efficiency of 97.6% and wide input voltage range
- ▶ Internal DC switch
- ▶ Transformerless GT topology
- ▶ Compact design
- ▶ Ethernet / RF technology / Wi-Fi
- ▶ Sound control
- ▶ Easy installation
- ▶ Comprehensive Growatt warranty program

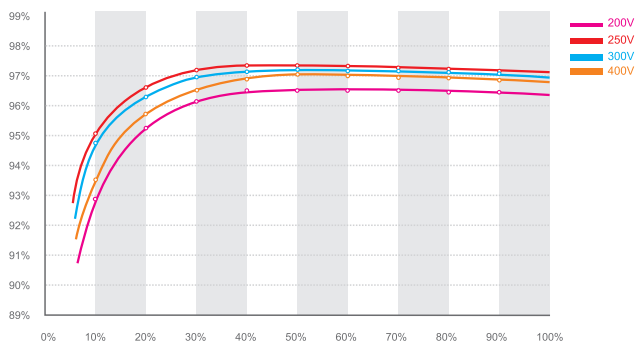

Growatt 3000-S efficiency



Growatt 1-3k -S topology

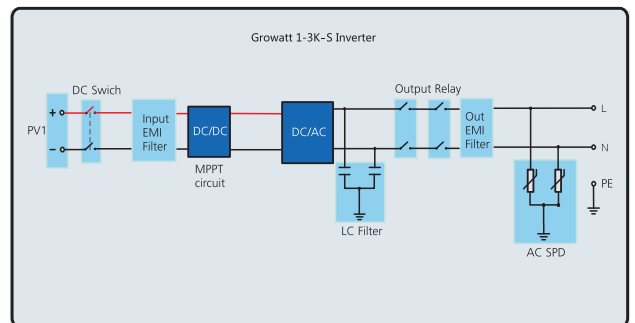

Datasheet	Growatt 1000-S	Growatt 1500-S	Growatt 2000-S	Growatt 3000-S
Input data (DC)				
Max. recommended PV power (for module STC)	1300W	1950W	2600W	3900W
Max. DC voltage	450V	450V	450V	550V
Start voltage	80V	80V	80V	80V
PV voltage range	70V-450V	70V-450V	70V-450V	70V-550V
MPP work voltage range/ nominal voltage	70V-450V/180V	70V-450V/250V	70V-450V/360V	70V-550V/360V
Full load dc voltage range	110V-400V	175V-400V	200V-400V	250V-500V
Max. input current	10A	10A	11A	13A
Max. input current per string	10A	10A	11A	13A
Number of independent MPP trackers /strings per MPP tracker	1/1	1/1	1/1	1/1
Output (AC)				
Rated AC output power	1000W	1600W	2000W	3000W
Max. AC power	1000W	1650W	2000W	3000W
Max. output current	4.7A	7.8A	9.5A	14.3A
AC nominal voltage; range	220,230,240V; 180Vac-280Vac	220,230,240V; 180Vac-280Vac	220,230,240V; 180Vac-280Vac	220,230,240V; 180Vac-280Vac
AC grid frequency; range	50,60 Hz;±5 Hz	50,60 Hz;±5 Hz	50,60 Hz;±5 Hz	50,60 Hz;±5 Hz
Power factor	1	1	1	1
Displacement power factor, configurable	0.8leading... 0.8lagging	0.8leading... 0.8lagging	0.8leading... 0.8lagging	0.8leading... 0.8lagging
THDi	<3%	<3%	<3%	<3%
AC connection	Single phase	Single phase	Single phase	Single phase
Efficiency				
Max. efficiency	97.4%	97.4%	97.4%	97.6%
Euro weighted efficiency	96.5%	97%	97%	97.3%
MPPT efficiency	99.5%	99.5%	99.5%	99.5%
Protection Devices				
DC reverse polarity protection	yes	yes	yes	yes
DC switch rating for each MPPT	opt	opt	opt	opt
Output over current protection	yes	yes	yes	yes
Output over voltage protection -varistor	yes	yes	yes	yes
Ground fault monitoring	yes	yes	yes	yes
Grid monitoring	yes	yes	yes	yes
Integrated all - pole sensitive leakage current monitoring unit	yes	yes	yes	yes
General Data				
Dimensions (W / H / D) in mm	271*267*142	271*267*142	271*267*142	271*320*142
Weight	6.1KG	6.1KG	6.1KG	8.8KG
Operating temperature range	- 25°C ... +60°C with derating above 45°C	- 25°C ... +60°C with derating above 45°C	- 25°C ... +60°C with derating above 45°C	- 25°C ... +60°C with derating above 45°C
Noise emission (typical)	≤25 dB(A)	≤25 dB(A)	≤25 dB(A)	≤25 dB(A)
Altitude	2000m without derating	2000m without derating	2000m without derating	2000m without derating
Self-Consumption night	<0.5 W	<0.5 W	<0.5 W	<0.5 W
Topology	Transformerless	Transformerless	Transformerless	Transformerless
Cooling concept	Natural	Natural	Natural	Natural
Environmental Protection Rating	IP65	IP65	IP65	IP65
Relative humidity	100%	100%	100%	100%
Features				
DC connection	H4/MC4(opt)	H4/MC4(opt)	H4/MC4(opt)	H4/MC4(opt)
AC connection	Connector	Connector	Connector	Connector
Display	LCD	LCD	LCD	LCD
Interfaces: RS232/ RF/ Wi-Fi/ LAN/GPRS	yes /opt/opt/opt/opt	yes /opt/opt/opt/opt	yes /opt/opt/opt/opt	yes /opt/opt/opt/opt
Warranty: 5 years / 10 years	yes /opt	yes /opt	yes /opt	yes /opt

Certificates and Approvals

CE, VDE 0126-1-1, IEC 62109, G83, AS4777, AS/NZS 3100, CEI0-21, VDE-AR-N4105, EN50438, CQC